



Prof. Satindar Bhagat

# Elementary Physics I

Kinematics, Dynamics And Thermodynamics

---

Elementary Physics I: Kinematics, Dynamics And Thermodynamics

1<sup>st</sup> edition

© 2014 Prof. Satindar Bhagat & [bookboon.com](http://bookboon.com)

ISBN 978-87-403-0632-3

# Contents

	<b>Dimensions – Units – Scalar or Vector</b>	<b>8</b>
<b>1</b>	<b>What is Physics?</b>	<b>9</b>
<b>2</b>	<b>Lengths at Play – Length, Area, Volume, Angle</b>	<b>10</b>
<b>3</b>	<b>Length – Time – Motion</b>	<b>18</b>
<b>4</b>	<b>Two Free Rides Plus Speed and Size of Moon</b>	<b>20</b>
<b>5</b>	<b>Kinematics – Description of Motion in One Dimension [Along x-axis]. (Point Particles)</b>	<b>24</b>
<b>6</b>	<b>Vector Algebra/ Trig. Identities</b>	<b>36</b>

I joined MITAS because  
I wanted **real responsibility**

The Graduate Programme  
for Engineers and Geoscientists  
[www.discovermitas.com](http://www.discovermitas.com)



**Month 16**

I was a construction  
supervisor in  
the North Sea  
advising and  
helping foremen  
solve problems

Real work  
International opportunities  
Three work placements



7	<b>Kinematics – Two Dimensions – Projectile Motion</b>	43
8	<b>Relative Velocities – Inertial Observers</b>	49
9	<b>Newton’s Laws (Point Objects)</b>	54
10	<b>Uniform Circular Motion – Kinematics and Dynamics</b>	62
11	<b>Some Consequences of Earth’s Rotation</b>	68
12	<b>Universal Law of Gravitation – Force</b>	71
13	<b>Conservation Principles</b>	80
14	<b>Potential Energy – Gravitational Force</b>	85

www.job.oticon.dk

**oticon**  
PEOPLE FIRST



15	<b>Conservation of Linear Momentum</b>	89
16	<b>Circular Motion When Speed is NOT Constant</b>	98
17	<b>Torque</b>	101
18	<b>Types of Motion of Rigid Body</b>	104
19	<b>Rolling Without Slip; etc</b>	107
20	<b>Conservation of Angular Momentum – Keplers Laws</b>	115
21	<b>Thermodynamics – Dynamics + One Thermal Parameter</b>	119
22	<b>Temperature (<math>\theta</math>)</b>	127
23	<b>Heat</b>	133

# INNOVATIVE LIKE YOU.

If you're hoping for a truly modern education, one where you're encouraged to speak your mind and to think long-term, both when it comes to your own future and the future of the planet. Then the University of Gothenburg is the place for you.

Study a Master's programme in Gothenburg, Sweden | [www.gu.se/education](http://www.gu.se/education)



Click on the ad to read more

24	Pressure of a Gas – Kinetic Energy	136
25	Modes of Heat Transfer	140
26	First Law of Thermodynamics	146
27	First Law – Thermodynamic Processes	150
28	Thermodynamic Processes	155
29	Second Law of Thermodynamics	157
30	Formulae	164



 Sweden  
Sverige

Linköping University –  
innovative, highly ranked,  
European

Interested in Computer Science? Kick-start your career  
with an English-taught master's degree.

→ [Click here!](#)

**li.u** LINKÖPING  
UNIVERSITY



# Dimensions – Units – Scalar or Vector

Time	T	<i>sec.</i>	S
Mass	M	<i>kg</i>	S
Length	L	<i>m</i>	S
Area	$L^2$	$m^2$	V
Volume	$L^3$	$m^3$	S
Angle	$L^0$	<i>radian</i>	V
Speed	$LT^{-1}$	$ms^{-1}$	S
Velocity	$LT^{-1}$	$ms^{-1}$	V
Displacement	L	<i>m</i>	V
Acceleration	$LT^{-2}$	$m/s^2$	V
Force	$MLT^{-2}$	$kg - m/s^2$ ( <i>newton</i> )	V
Work	$ML^2T^{-2}$	<i>N - m (Joule)</i>	S
Energy	$ML^2T^{-2}$	<i>Joule</i>	S
Momentum	$MLT^{-1}$	$kg - m/s$	V
Angular Velocity	$L^0T^{-1}$	<i>rad/sec</i>	V
Angular Acceleration	$L^0T^{-2}$	<i>rad/sec<sup>2</sup></i>	V
Torque	$ML^2T^{-2}$	<i>N-m</i>	V
Moment of Inertia	$ML^2$	$kg - m^2$	S
Temperature	$\theta$	$^{\circ}C, ^{\circ}F, ^{\circ}K$	S
Heat	$ML^2T^{-2}$	<i>Joule</i>	
Specific Heat	$L^2T^{-2}\theta^{-1}$	<i>Joule/kg/K</i>	
Thermal Conductivity	$MLT^{-3}\theta^{-1}$	<i>Joule/m-s-C</i>	
Pressure	$ML^{-1}T^{-2}$	$N/m^2$	S
Density	$ML^{-3}$	$kg - m^3$	
GR Constant	$M^{-1}L^3T^{-2}$	$N - m^2 / (kg)^2$	
Boltzman Constant	$ML^2T^{-2}\theta^{-1}$	<i>Joule/K</i>	
Stefan Constant	$MT^{-3}\theta^{-4}$	$J - sec^{-1} - m^{-2} - K^{-4}$	
Power	$ML^2T^{-3}$	<i>Joule/sec (watt)</i>	
Coefficient of Friction:		<b>Dimensionless Ratio</b>	
Expansion Coefficient	$\theta^{-1}$	$(^{\circ}C)^{-1}$	S
Angular Momentum	$ML^2T^{-1}$	$kg - m^2/s$	V
Entropy	$ML^2T^{-2}\theta^{-1}$	$J/K$	S
Frequency	$T^{-1}$	<i>hertz</i>	S



# 1 What is Physics?

## Introduction

What is the content of the science which goes under the title “Physics”? Put succinctly, Physics encompasses two fields of intellectual endeavor.

In the first, the purpose is to provide the simplest, most economical and most elegant description of “nature as we know it.” The last part of the previous sentence of necessity implies that physics is an experimental science. No matter how persuasive a body of thought, if it is not supported by any observation it does not belong in the realm of physics. Of course, since new observational techniques based on what is already known are continuously under development, it may take decades before new results emerge. So one must maintain an open mind and be willing to accept that literally nothing is ever totally complete. A new finding may be just around the corner and if severally observed and confirmed, it will be enthusiastically incorporated.

The second field is in many ways more fundamental, deeper and also more challenging. In our discussion in Physics I/II we will encounter only one or two examples of it. In this case, the purpose is not to formulate a credible description of what is already known but rather to appeal to intuition and the flights of imagination which are fundamental attribute of the human brain. As Einstein said, “unmitigated curiosity is the most powerful driver for the discovery of new knowledge.”

Time and again, a physicist comes along to point out that something is missing from the existing relationships and in a bold and courageous step proposes an entirely new idea which challenges the experimentalist to devise methods to test the legitimacy of the proposal. If the idea is correct, eventually an observation will be made confirming the prediction. Its universal adoption will follow as more and more experimental results appear in accord with the initial claim.

Nature, of course, is our ultimate teacher. Once again, it pays to recall Einstein’s statement, “The most incomprehensible thing about nature is that nature is comprehensible.” Indeed, we have every reason to claim that nature may be complex and sometimes very puzzling but never capricious.

In PHYS I we will deal with natural phenomena pertaining to motion of particles and rigid bodies supplemented by a brief discussion of Thermodynamics. Arguably, physics provides the bases for all scientific endeavors and is itself deeply imbedded in mathematics. Algebra and trigonometry will be use throughout.

## 2 Lengths at Play – Length, Area, Volume, Angle

Since Physics is a science dependent on measurements, apart from some notable exceptions, all physical quantities have units. For instance, if someone asks you, “how tall are you?” and you reply 6 you have not told them anything, but if you say 6 feet , then the enquirer knows precisely what you mean (provided, of course, he/she was raised in a culture where a foot is an accepted measure of length, we return to this in the sequel).

A closely allied quantity is what is called a physical DIMENSION. Again every physical quantity can be expressed as a product of a set of fundamental factors Length (L), Time (T), etc, called Dimensions.

The above discussion leads us to formulate the cardinal rule for any equation in physics. If we write:

$$A+B=C+D$$

Then every one of the quantities A, B, C, and D must have the **SAME UNITS and of course SAME DIMENSIONS: NEVER WRITE AN EQUATION WHICH IS DIMENSIONALLY INCORRECT.** We will emphasize this at every step. No matter how elegant an equation, if it is dimensionally incorrect it will fetch a “ZERO” in an exam.

So, now we start from scratch and begin to build a description of the universe. Since it occupies space the very first quantity we invoke is a measure of the extent of space along a line segment. Right away, we should begin by building a

→ PHYSICAL QUANTITY	<b>MASTER TABLE</b>	
	DIMENSIONS UNIT	s/v

(the last column distinguishes scalar/vector and the full significance will develop later)

A line segment spans the extent of space in one space dimension. Let us see the kinds of lengths we will encounter The SI (systems international) unit is the meter, which is the distance between two scratches on a bar of metal. (Technically, these days it is defined in terms of light wavelengths) However, we want to gauge it from everyday experience. The easiest way to get a feel for it is to note that the typical height of a human being is in the neighborhood of 1.5m to 2m.

Starting with 1m if we go to shorter lengths we get 1 centimeter(cm)= $10^{-2}m$  [about the diameter of a finger] 1 micrometer (micron,  $\mu m$ )= $10^{-6}m$  [roughly the diameter of human hair] 1 nanometer (nm)=  $10^{-9}nm$  [about ten times the diameter of the hydrogen atom] 1femtometer (fm)= $10^{-15}m$  [diameter of a nucleus].

When we envisage lengths larger than 1m it is useful to keep in mind some useful conversions since in the U.S. we are not customarily using SI units.

Thus            One inch=2.54cm  
                   One foot=30.48cm  
                   One Yard=91.44cm  
                   One Mile=1609m=1.609 kilometers

The range of lengths is again very large

Typical city 30km  
 Country 1000km  
 Radius of Earth about 6400km  
 Distance to moon about 400,000km  
 Distance to Sun  $1.5 \times 10^8 km$   
 Distance to one of the farthest objects  $10^{23}m$

So in terms of going from the smallest to the largest, the lengths vary by  $10^{38}$ , a huge span indeed.

Once you have length you can create an area by moving the length parallel to itself you are essentially summing ( $l \times b$ ) squares each of area  $(1 \times 1)m^2$ .

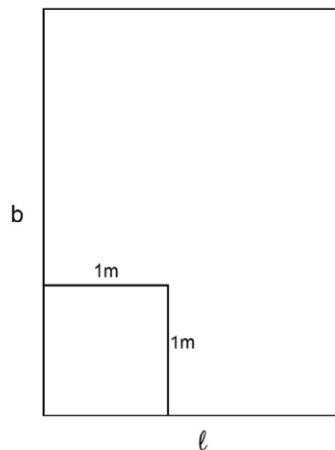

$$A = l \times b$$

Immediately, note the implications of the cardinal rule: You cannot equate an area to a length.

Next, if you move the area parallel to itself you create a volume and so Volume

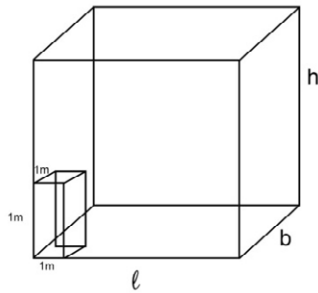

$$V = lbh$$

because again

you are summing

$V$  number of cubes,  
each of Volume  $1m^3$ .

Indeed, with the help of 3 lengths we can fill the entire universe.

Next, still using length as the only dimension we can talk of angle ( $\vartheta$ ) as a measure of the inclination between two lines. Let  $OA = r$

Rotate  $OA$  by the amount

$\vartheta$  about one end ( $O$ ), the

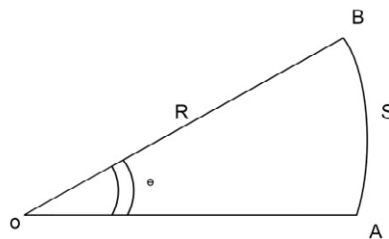

other end A moves from A to B along a circular arc of length S. The angle  $\vartheta$  which measures the inclination between OA and OB is defined by

$$\vartheta = \frac{S}{R}$$

The unit value requires  $S=R$  and is called a radian

The ratio of the circumference of a circle to its diameter is  $\pi$  radians and if we recall that in common parlance the angle between two antiparallel lines is  $180^\circ$

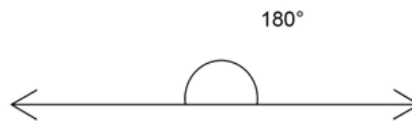

we can write  $180^\circ = \pi$  radians

**STUDY FOR YOUR MASTER'S DEGREE  
IN THE CRADLE OF SWEDISH ENGINEERING**

Chalmers University of Technology conducts research and education in engineering and natural sciences, architecture, technology-related mathematical sciences and nautical sciences. Behind all that Chalmers accomplishes, the aim persists for contributing to a sustainable future – both nationally and globally.

Visit us on **Chalmers.se** or **Next Stop Chalmers** on facebook.

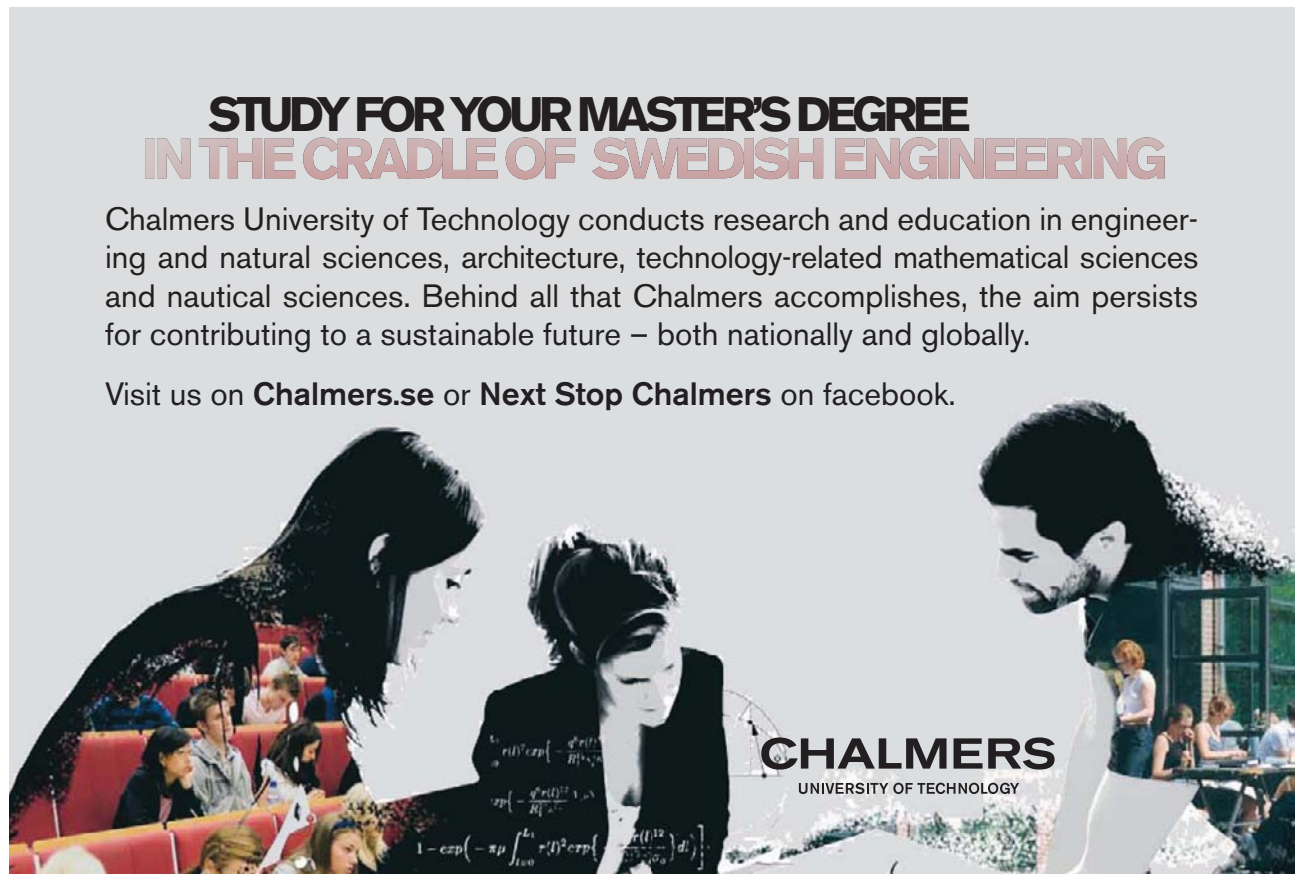

**CHALMERS**  
UNIVERSITY OF TECHNOLOGY



**Examples:**

**Area of Triangle**

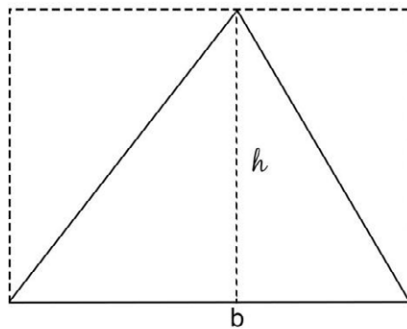

The area of a  $\Delta$  of base  $b$  and height  $h$  is essentially one half of the area (see figure) of a rectangle of sides  $b$  and  $h$  so

$$\Delta Area = \frac{1}{2}bh$$

**Circle**

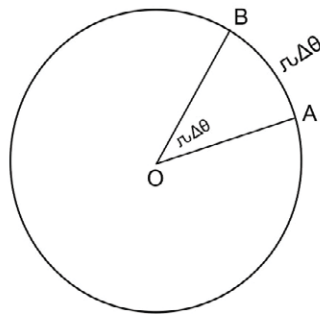

The area of a circle can be calculated by splitting it into a bunch of  $\Delta$ 's (see figure)

$$\text{Areas of } \Delta OAB = \frac{1}{2} \times r\Delta\theta \times r = \frac{1}{2}r^2\Delta\theta$$

$$\text{Area of circle} = \frac{1}{2}r^2 \sum \Delta\theta$$

$$\sum \Delta\theta = 2\pi \text{ So area of circle is } \pi r^2$$

### Volume of Cylinder

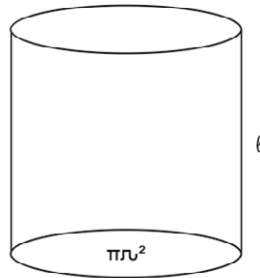

of radius  $r$  and  
length  $l$  can be created  
by moving a circle  
of area  $\pi r^2$  parallel  
to itself so  $V_{cyl} = \pi r^2 l$

[Incidentally, if you unfold the surface its area will be  $(2\pi r l)$ ]

**MÄLARDALEN UNIVERSITY SWEDEN**

**WELCOME TO OUR WORLD OF TEACHING!**  
INNOVATION, FLAT HIERARCHIES AND OPEN-MINDED PROFESSORS

**STUDY IN SWEDEN - CLOSE COLLABORATION WITH FUTURE EMPLOYERS**  
MÄLARDALEN UNIVERSITY COLLABORATES WITH MANY EMPLOYERS SUCH AS ABB, VOLVO AND ERICSSON

**TAKE THE RIGHT TRACK**  
GIVE YOUR CAREER A HEADSTART AT MÄLARDALEN UNIVERSITY  
[www.mdh.se](http://www.mdh.se)

**DEBAJYOTI NAG**  
SWEDEN, AND PARTICULARLY MDH, HAS A VERY IMPRESSIVE REPUTATION IN THE FIELD OF EMBEDDED SYSTEMS RESEARCH, AND THE COURSE DESIGN IS VERY CLOSE TO THE INDUSTRY REQUIREMENTS.  
HE'LL TELL YOU ALL ABOUT IT AND ANSWER YOUR QUESTIONS AT [MDUSTUDENT.COM](http://MDUSTUDENT.COM)



## Sphere

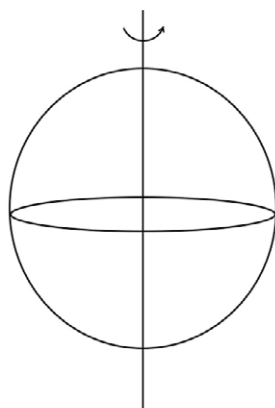

You can generate a sphere by rotating a circle about one of its diameters (figure)

It turns out that  
 volume of sphere =  $\frac{4\pi}{3}r^3$   
 surface areas of sphere =  $4\pi r^2$

## Angle

**Question** Which is bigger, the sun or the moon?

It is interesting to note that when we look at the “angular width” they are nearly equal.

Diameter of moon  $\cong 3200\text{km}$

Distance to Moon =  $400,000\text{km}$

$$\Delta\theta_{\text{Moon}} = \frac{3200}{400,000} = 8 \times 10^{-3} \text{radian}$$

Diameter of Sun =  $1.4 \times 10^6 \text{ km}$

Distance to Sun =  $2 \times 10^8 \text{ km}$

$$\Delta\theta_{\text{Sun}} \cong 7 \times 10^{-3} \text{radian}$$

You can do the following experiment:

On a full moon night, take a dime and measure how far it must be from your eye so you can “cover” the moon completely.



**Question:** Devise a simple experiment to estimate the radius of the Earth schematically, we can draw the picture below when two amateur physicists take on this investigation

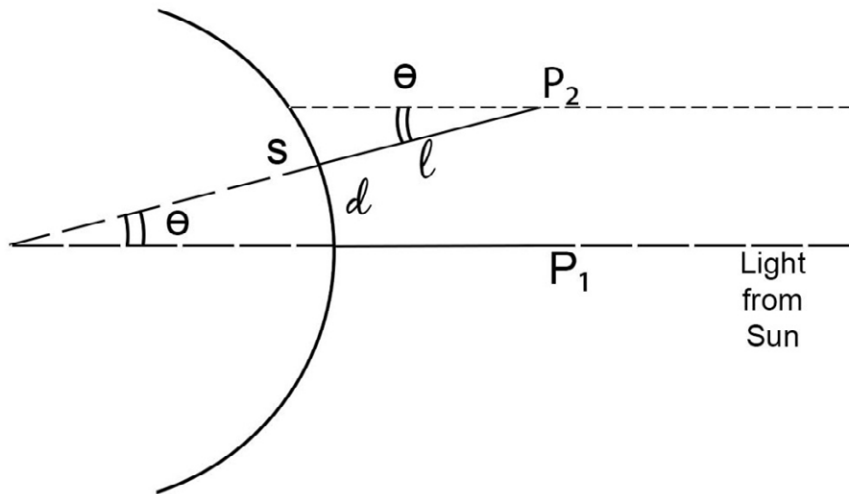

Note:  $R_E$  is enormous compared to  $l$

When Sun is vertically above  $P_1$  its shadow has no size, but for  $P_2$  the size is  $S$ . The angle  $\theta = \frac{s}{l} = \frac{d}{R_E}$  so knowing  $d$  you can estimate  $R_E$ .



## Develop the tools we need for Life Science Masters Degree in Bioinformatics

Bioinformatics is the exciting field where biology, computer science, and mathematics meet.

We solve problems from biology and medicine using methods and tools from computer science and mathematics.

Read more about this and our other international masters degree programmes at [www.uu.se/master](http://www.uu.se/master)



Click on the ad to read more

# 3 Length – Time – Motion

## Coordinate Systems

Once we have a way to measure the dimensions of length along three mutually perpendicular directions we can locate the position of any object in the universe. We begin by choosing a point which we call the origin (0) and draw three mutually perpendicular lines which we label x-axis, y-axis and z-axis

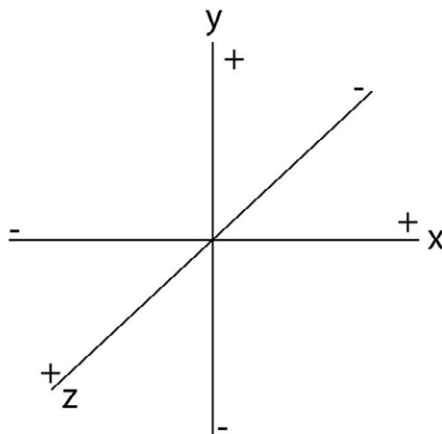

x → left-right

y → up-down

z → back and forth

The location of any point is then uniquely determined by the triplet of numbers called “coordinates”. For instance, if we write (3m, 4m, 5m) that fixes the point where starting for 0 we go 3m right, 4m up and 5m forward. Alternately (-3m, 4m, -5m) is a point reached by going 3m left, 4m up and 5m back.

So we have a well defined method for fixing the position of any object in our universe. However, if all objects always remained fixed the universe would be very dull. It is far more fun to take the next step: our “point” object is moving. This requires us to introduce the next “player” in our description of the universe.

## TIME

All of us are aware of the passage of time, but establishing a succinct definition of time is by no means easy. Indeed, we use concepts of “before” and “after” or alternatively “cause” and “effect” to put a sequence of events in order to mark the flow of TIME. It is therefore not surprising that a meaningful method of measuring time developed long after people had learned to gauge the extent of space; the development of the simple clock owes its existence to the brilliant observation made by Galileo that the time elapsed for the chandeliers, in a cathedral, to swing back and forth was controlled only by their length (incidentally, he made the measurement with reference to his pulse beat). We will discuss the precise reasons for this much later, but once this finding became available the simple pendulum clock followed soon after and measurement of time got a firm footing. Later, we will show that the period of a pendulum of length  $l$  is

$$T = 2\pi\left(\frac{l}{g}\right)^{1/2} \text{ where } g = 9.8m/s^2.$$

So, in our master table the next row is

TIME	$T^1$	second	scalar
------	-------	--------	--------

and the intervals of every day interest are:

minute	60sec
hour	60min.
Day*	24hrs.
Year**	$365\frac{1}{4}$ days

\*Time taken by Earth to turn on its axis once.

\*\*Time taken by earth to complete one revolution around the Sun.

## MOTION

Once we have a measure of both position and time we can introduce the simplest parameter to describe motion: speed (S)

$$S = \frac{\text{distance traveled}}{\text{time taken}}$$

S	$LT^{-1}$	m/sec	scalar
---	-----------	-------	--------

It is useful to look at an everyday speed to relate it to SI units.

$$60mph = 88ft/sec = 26.82m/sec$$

## 4 Two Free Rides Plus Speed and Size of Moon

a) The earth gives us two free rides

(i) Due to rotation of Earth about its axis

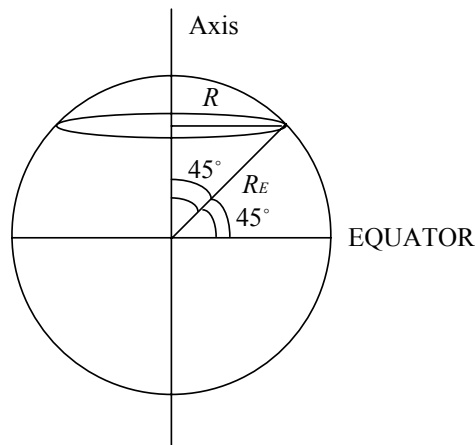

**Nido**

**Luxurious accommodation**

**Central zone 1 & 2 locations**

**Meet hundreds of international students**

**BOOK NOW and get a £100 voucher from voucherexpress**

**Nido Student Living - London**

**Visit [www.NidoStudentLiving.com/Bookboon](http://www.NidoStudentLiving.com/Bookboon) for more info.**

**+44 (0)20 3102 1060**



Time for Rotation = 24 hours

Radius of Earth = 4000 miles = 6400 km

Our Latitude =  $45^\circ$

Radius of *Circle* =  $R_E \sin 45 = R_E \cos 45$

$$\begin{aligned} \text{Speed Due to Rotation} &= \frac{2\pi R}{24} \text{mph} \\ &= \frac{2\pi \times 4000 \times \sin 45}{24} \approx 700 \text{ mph} \\ &\cong 1120 \text{ km/hour} \end{aligned}$$

(ii) Due to revolution of Earth around the sun

Radius of Earth's Orbit = 93,000,000 miles

Time for Revolution = 1 year =  $(365.25 \times 24)$  hours

$$\begin{aligned} \text{Speed due to Revolution} &= \frac{2\pi \times 93 \times 10^6}{235.25 \times 24} \\ &\approx 67,000 \text{ mph} \end{aligned}$$

b) Speed and Size of Moon:

To access speed of moon we need two observers to go out at midnight on a full moon night and observe a star such that the moon intercepts the light from the star. Star is very far so light from it is a parallel beam. Both observers on same latitude so both have same velocity  $V_0$  due to Earth's rotation.

The picture is

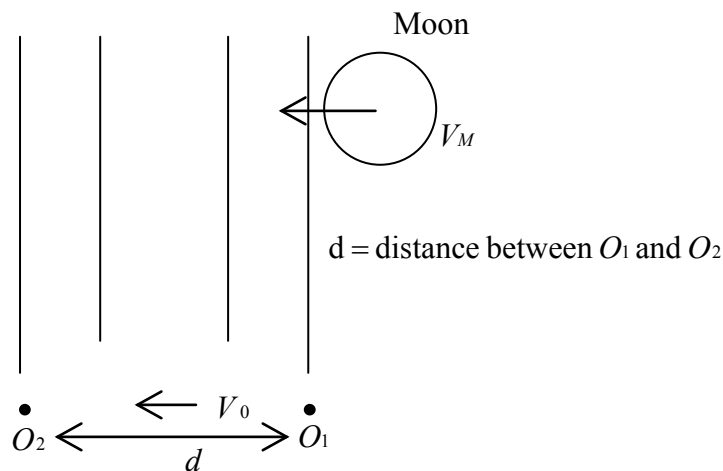

At time  $t_1$  moon intercepts light from star as seen by  $O_1$

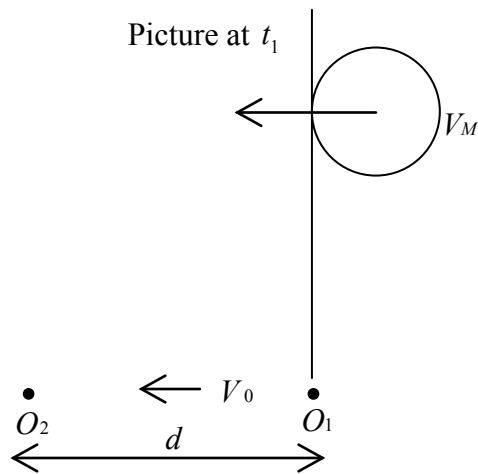

At time  $t_2$  moon intercepts light from star as seen by  $O_2$

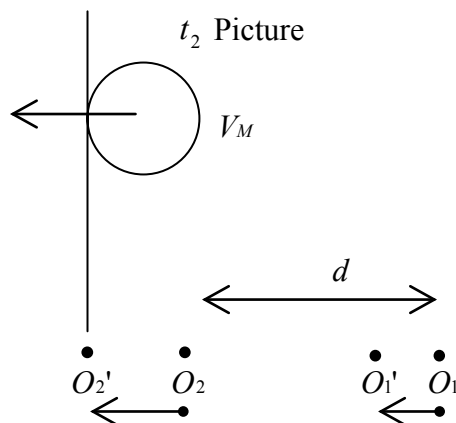

$O_2'O_2 = O_1'O_1 =$  distance travelled by observer due to motion of Earth  
Hence

$$V_M(t_2 - t_1) = d + V_0(t_2 - t_1)$$

Speed of moon 
$$V_M = \frac{d}{(t_2 - t_1)} + V_0$$

Once we know  $V_M$  a single observer can “measure” diameter of moon.

Again, concentrate on light from a star being intercepted by moon.

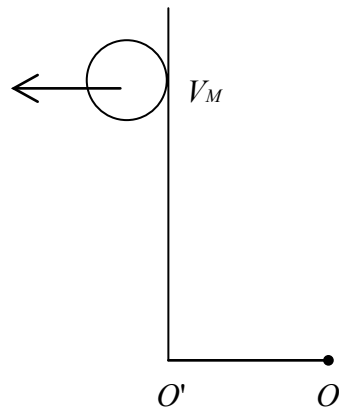
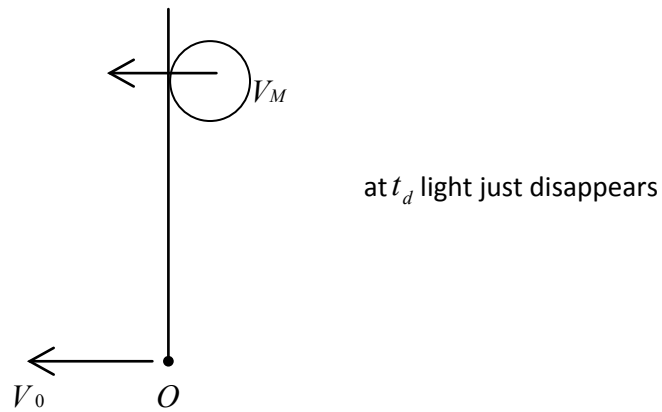

$$\text{Distance moved by moon} = d_M + V_0(t_A - t_d)$$

Where  $d_M =$  diameter of moon

$$V_M \times (t_A - t_d) = d_M + V_0(t_A - t_d)$$

$$d_M = (V_M - V_0)(t_A - t_d)$$

Which will allow us to measure  $d_M$ .

# 5 Kinematics – Description of Motion in One Dimension [Along x-axis]. (Point Particles)

## Definitions

### Position Vector:

$$\underline{x}(t) = A\hat{x} \quad \text{or} \quad -A\hat{x}$$

$A$  is magnitude

$+\hat{x}$  vector points right

$-\hat{x}$  vector points left



**Brain power**

By 2020, wind could provide one-tenth of our planet's electricity needs. Already today, SKF's innovative know-how is crucial to running a large proportion of the world's wind turbines.

Up to 25 % of the generating costs relate to maintenance. These can be reduced dramatically thanks to our systems for on-line condition monitoring and automatic lubrication. We help make it more economical to create cleaner, cheaper energy out of thin air.

By sharing our experience, expertise, and creativity, industries can boost performance beyond expectations. Therefore we need the best employees who can meet this challenge!

The Power of Knowledge Engineering

Plug into The Power of Knowledge Engineering.  
Visit us at [www.skf.com/knowledge](http://www.skf.com/knowledge)

**SKF**



**Displacement Vector:** Measures change of position

$$\Delta \underline{x} = \underline{x}(t_2) - \underline{x}(t_1)$$

Here,  $\underline{\Delta x}$  is along  $+\hat{x}$

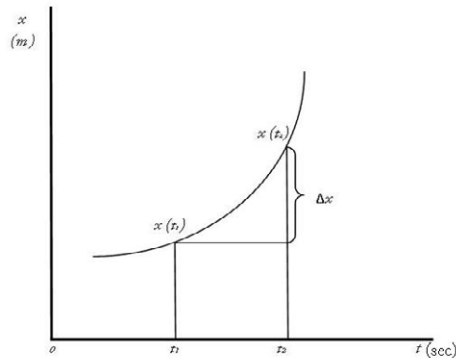

**Average Velocity Vector:** Measures rate of change of position with time over a finite time interval  $(t_2 - t_1)$

$$\langle \underline{v} \rangle = \frac{x(t_2) - x(t_1)}{(t_2 - t_1)} \hat{x}$$

It is the slope of the chord.

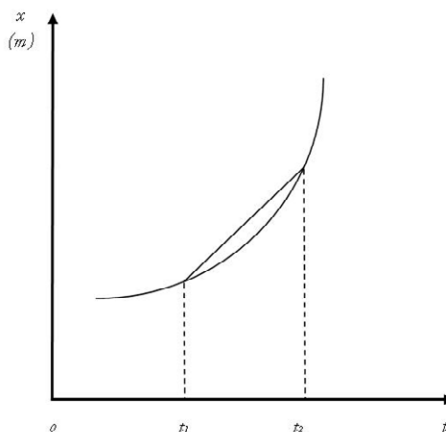

**Instantaneous Velocity Vector:** Measures rate of change of position with time when time interval goes to zero

$$\Delta t \rightarrow 0$$

$$\underline{\Delta x} \rightarrow 0$$

$$\underline{v} = \lim_{\Delta t \rightarrow 0} \frac{\underline{\Delta x}}{\Delta t}$$

Slope of tangent to  $x$  vs.  $t$  graph

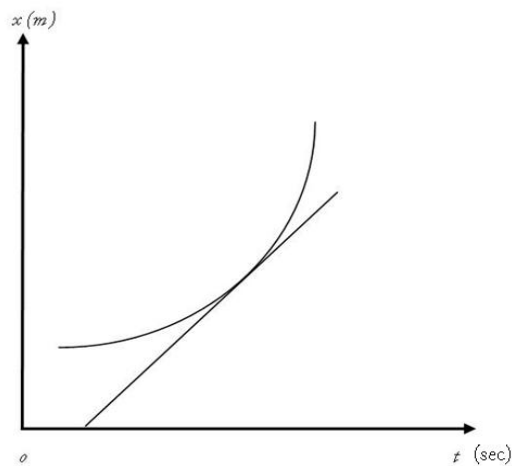

**Average Acceleration Vector:** Measures rate of change of velocity vector during a finite time interval.

$$\langle \underline{a} \rangle = \frac{\underline{v}(t_2) - \underline{v}(t_1)}{(t_2 - t_1)}$$

Slope of chord in  $v$  vs.  $t$  graph

**Instantaneous Acceleration Vector:** Measures rate of change of velocity vector when time interval goes to zero

$$\Delta t \rightarrow 0$$

$$\underline{\Delta v} \rightarrow 0$$

$$\underline{a} = \lim_{\Delta t \rightarrow 0} \frac{\underline{\Delta v}}{\Delta t}$$

**Uniform Motion**

$$\underline{a} = 0$$

$$\underline{v} = v\hat{x} \text{ is constant}$$

In this case  $x$  vs.  $t$  graphs will be straight line whose slope is  $v$  m/s

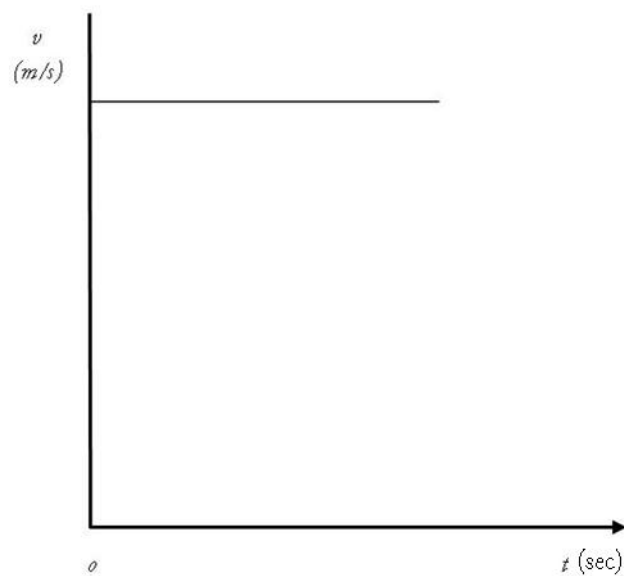
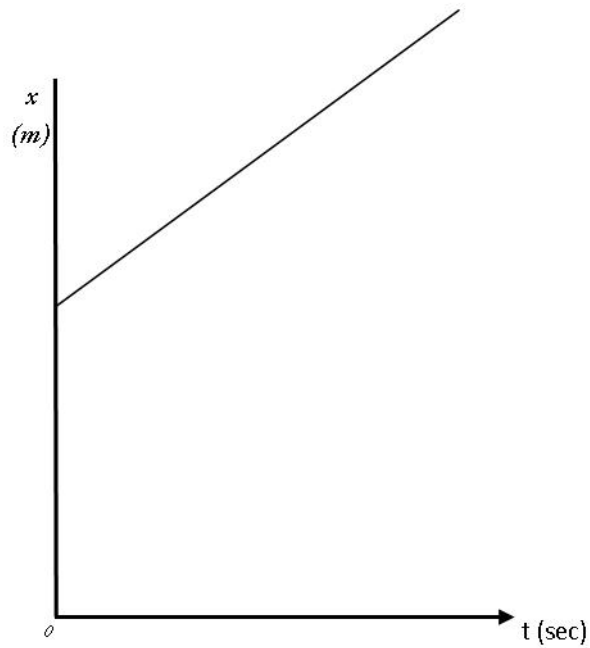

Since  $v$  measures change in  $x$  every second, a table of  $\Delta x$  vs.  $t$  will look like

$t$ (sec)	$\Delta x$ (m)
0	0
1	$v$
2	$2v$
3	$3v$
4	$4v$

That is  $\Delta x$  is equal to area under  $v$  vs.  $t$  graph. In  $t$  seconds

$$\Delta x = vt$$

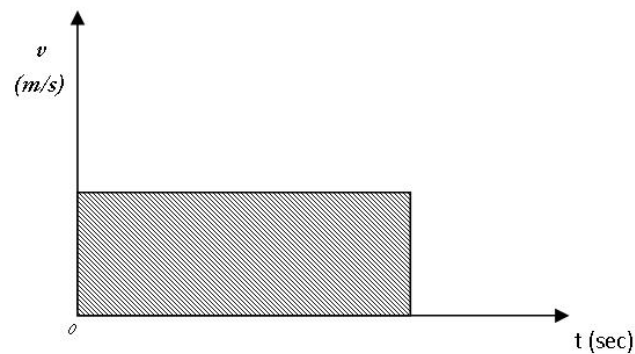

**GET A MASTER'S DEGREE IN UMEÅ!**

- modern campus • world class research • 32 000 students
- top class teachers • ranked nr 1 in Sweden by international students

**Master's programmes:**

- Architecture
- Industrial Design
- Science
- Engineering

Download brochure here!



**UMEÅ UNIVERSITY**  
FACULTY OF SCIENCE & TECHNOLOGY



To write down  $x$  at  $t$  seconds, we must know where object was at  $t = 0$  and get uniform motion equation

$$\underline{x}(t) = \underline{x}(0) + \underline{v}t = (x_i + vt)\hat{x} \quad (1)$$

$x_i$  = initial position

So the rule is: To calculate  $\underline{x}(t)$  add the area under  $\underline{v}$  vs.  $t$  graphs to the value of  $\underline{x}$  at  $t = 0$ .

**Next: MOTION WITH CONSTANT ACCELERATION**

$$\underline{a} = a\hat{x} \quad (2)$$

Now  $\underline{v}$  is **NOT** CONSTANT. Indeed, since  $a$  measures change of  $\underline{v}$  every second  $v$  vs.  $t$  graphs must look like

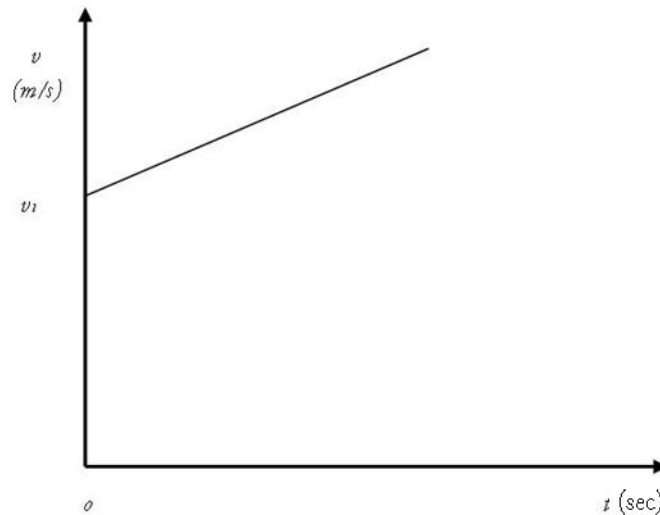

Now  $\underline{v}$  is changing by  $a \text{ m/s}^2$  every second so table of  $\Delta v$  vs.  $t$  must be

$t$ (sec)	$\Delta v$ (m/s)
0	0
1	$a$
2	$2a$
3	$3a$
4	$4a$

Change of  $v$  during  $t$  seconds is area under  $a$  vs.  $t$  graph.

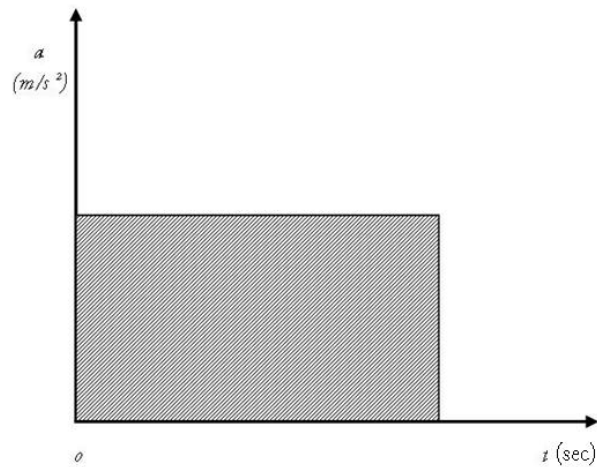

And again to write  $\underline{v}$  at any time  $t$  we must know  $\underline{v}$  at  $t = 0$  and write for constant acceleration

$$\underline{v}(t) = (v_i + at)\hat{x} \quad \rightarrow (3)$$

$v_i \hat{x}$  is initial velocity

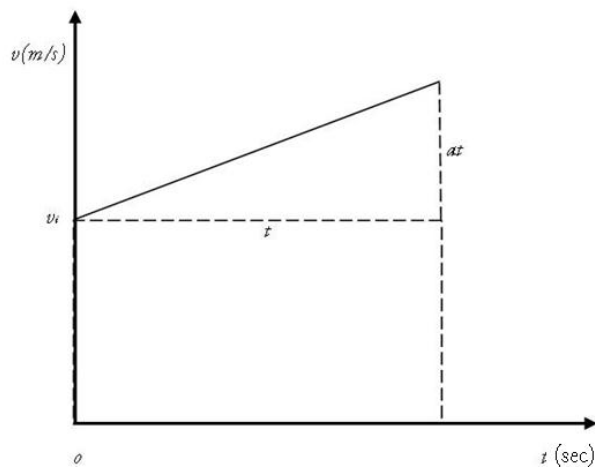

1. To calculate  $x$  as a function of  $t$  we can proceed in two ways:

Use the rule written under Eq(1). Draw graph of Eq(3) then change of  $x$  is area under  $v$  vs.  $t$  graph

$$\Delta x = v_i t + \frac{1}{2} at^2$$

$$\text{Hence } \underline{x}(t) = \left( x_i + v_i t + \frac{1}{2} at^2 \right) \hat{x} \quad \rightarrow (4)$$

2. We can use (3) to calculate average velocity between  $0$  and  $t$  since  $v$  is increasing linearly with time

$$\langle v \rangle = \frac{v_i + v_i + at}{2} = v_i + \frac{at}{2}$$

Displacement  $\Delta x = \left( v_i + \frac{at}{2} \right) t$  and again yield Eq(4)

To Summarize the kinematic equations are

$$\underline{a} = a\hat{x} \tag{2}$$

$$\underline{v}(t) = (v_i + at)\hat{x} \tag{3}$$

$$\underline{x}(t) = \left( x_i + v_i t + \frac{1}{2} at^2 \right) \hat{x} \tag{4}$$

Eqs(3) and (4) can be combined to yield a useful relation between magnitudes of  $v$  and  $x$

From (3)  $t = \frac{v - v_i}{a}$

**Scholarships**

**Open your mind to new opportunities**

With 31,000 students, Linnaeus University is one of the larger universities in Sweden. We are a modern university, known for our strong international profile. Every year more than 1,600 international students from all over the world choose to enjoy the friendly atmosphere and active student life at Linnaeus University. Welcome to join us!

**Linnaeus University**  
Sweden

**Ln.u.se**

**Bachelor programmes in**  
Business & Economics | Computer Science/IT | Design | Mathematics

**Master programmes in**  
Business & Economics | Behavioural Sciences | Computer Science/IT | Cultural Studies & Social Sciences | Design | Mathematics | Natural Sciences | Technology & Engineering

**Summer Academy courses**



Substitute in (4)

$$x = x_i + v_i \left( \frac{v - v_i}{a} \right) + \frac{1}{2} a \left( \frac{v - v_i}{a} \right)^2$$

$$= x_0 + \frac{v^2 - v_i^2}{2a}$$

Or

$$v^2 = v_i^2 + 2a(x - x_i) \quad (5)$$

Eq(5) is useful when you know position and not time.

### FREE FALL

So, why are we so interested in discussing motion where  $\underline{a}$  is a constant? The reason is that near the surface of the Earth every **unsupported** object has a constant acceleration of about  $9.8m/s^2$  directed along the radius of the Earth and pointing toward the center. – **acceleration due to gravity**

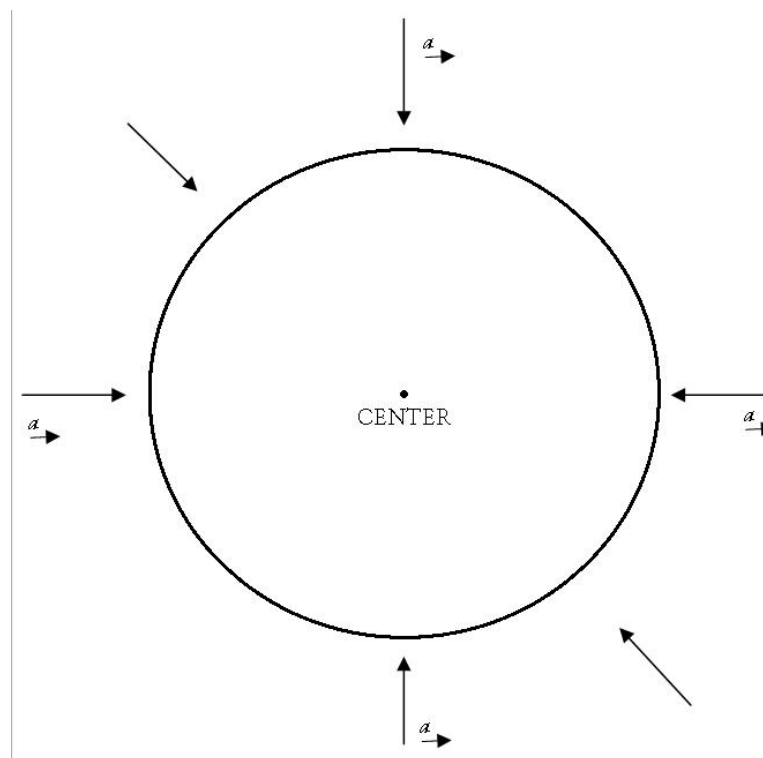

Locally, we pretend that the Earth is flat, choose coordinate system where  $x$  is along horizontal  $y$  along vertical with positive up and therefore write that the acceleration due to gravity is

$$\underline{a} = -9.8m/s^2 \hat{y} \quad (6)$$



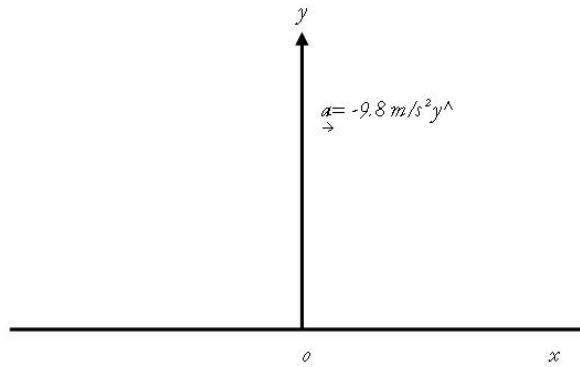

Now we can use Eqs(3),(4), and (5) for motion along  $y$  and write

$$\underline{v} = (v_i - 9.8t)\hat{y} \quad (7)$$

$$\underline{y} = (y_i + v_i t - 4.9t^2)\hat{y} \quad (8)$$

$$v^2 = v_i^2 - 19.6(y - y_i) \quad (9)$$

**Notes**

1. It is very **important** to note that if you throw a ball straight up or straight down the **only quantity** you can control is its **initial velocity**  $v_i$ . Once it leaves your hand the motion is controlled only by the Earth via Eqs(6) through (9). THE ACCELERATION IS THE SAME AT ALL TIMES DURING THE FLIGHT OF THE BALL.
2. Eqs(6) through (9) apply for free fall on the moon or any other planet. The only difference is that the magnitude of  $\underline{a}$  is not the same as it is on Earth. For instance, on the moon

$$\underline{a} = -1.63 m/s^2 \hat{y} \quad (\text{Moon})$$

**EXAMPLE**

Let  $\underline{v} = +v_i \hat{y}$   $y_i = 0$ . That is, at  $t = 0$  an object is thrown straight up with a velocity of  $+v_0 m/s^2 \hat{y}$  starting from the ground ( $y_i = 0$ ). It will go up to some height. Turn around and come back to ground according to Eqs(5) through (9). We can plot its acceleration, velocity and position as a function of time.

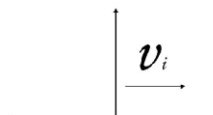

### Acceleration

Constant at all times. Negative sign means pointing down

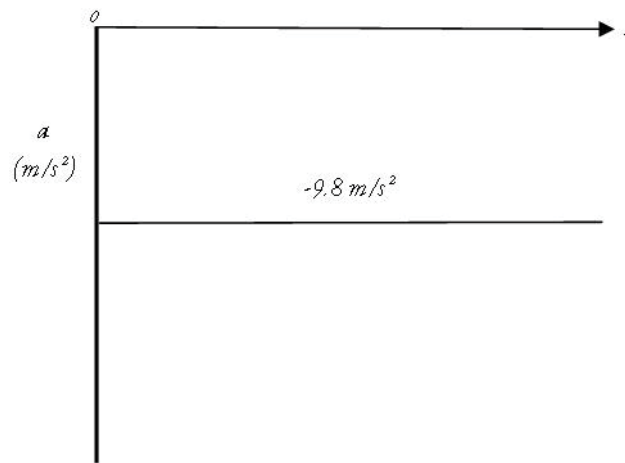

In the past four years we have drilled

# 89,000 km

That's more than **twice** around the world.

**Who are we?**  
We are the world's largest oilfield services company<sup>1</sup>. Working globally—often in remote and challenging locations—we invent, design, engineer, and apply technology to help our customers find and produce oil and gas safely.

**Who are we looking for?**  
Every year, we need thousands of graduates to begin dynamic careers in the following domains:

- **Engineering, Research and Operations**
- **Geoscience and Petrotechnical**
- **Commercial and Business**

**What will you be?**

**Schlumberger**

[careers.slb.com](https://careers.slb.com)

<sup>1</sup>Based on Fortune 500 ranking 2011. Copyright © 2015 Schlumberger. All rights reserved.



**Velocity**

Reaches highest point in  $\frac{v_i}{9.8}$  seconds. At that point, velocity is zero so it stops rising. Returns to Earth in  $\frac{2v_i}{9.8}$  seconds and has velocity  $-v_0\hat{y}$  just before it hits the ground.

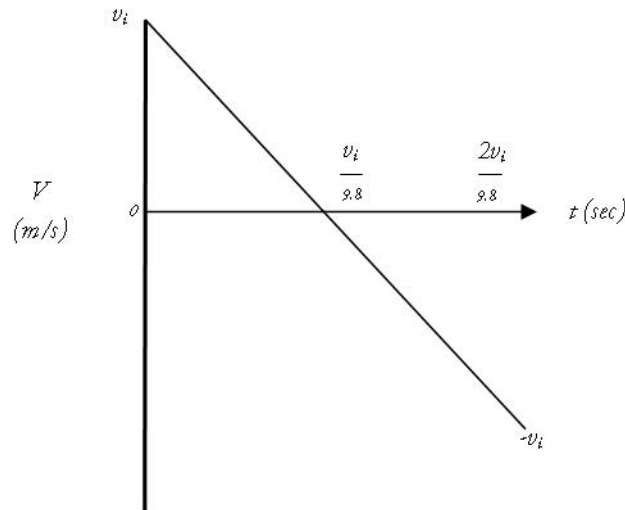

**Position**

At highest point,  $v = 0$  so from Eq(9)  $y_{top} = \frac{v_i^2}{19.6}$ .

**Combines Flight Picture**

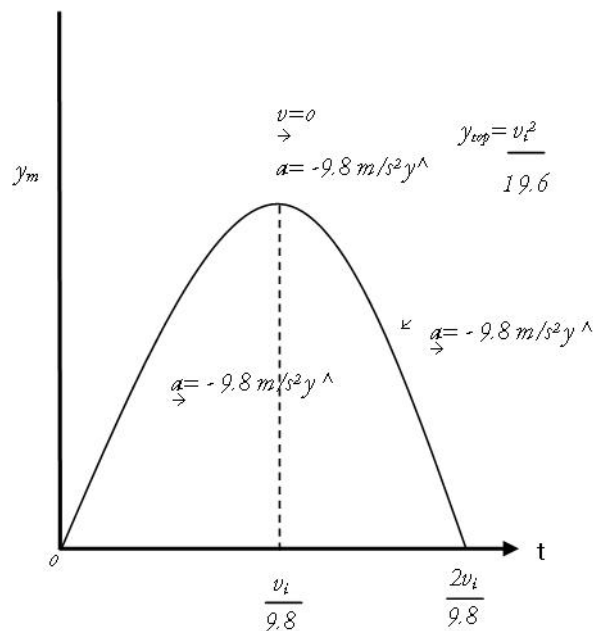

# 6 Vector Algebra/ Trig. Identities

**Vector** ( $\underline{V}$ ): A mathematical object which has both a magnitude and a direction. **Scalar** (S): Has magnitude only

1. If you multiply a vector  $\underline{V}$  by a scalar S you get a vector  $\underline{V}' = S\underline{V}$  such that  $\underline{V}' \parallel \underline{V}$  and has magnitude SV. This property allows us to express any vector as a product of a scalar (magnitude) and a unit vector (magnitude 1, direction only). Hence, we have written:

$$\underline{A} = A\hat{x}$$

as a vector of magnitude A in the +x direction. Indeed, a vector along any direction  $\hat{d}$  can be written as:

$$\underline{V} = V\hat{d}$$

2. **Addition of Vectors.** Given vectors  $\underline{V}_1$  and  $\underline{V}_2$  we want to determine the **Resultant Vector**

$$\underline{R} = \underline{V}_1 + \underline{V}_2$$

There are three methods for doing this:

## Trust and responsibility

NNE and Pharmaplan have joined forces to create NNE Pharmaplan, the world's leading engineering and consultancy company focused entirely on the pharma and biotech industries.

Inés Aréizaga Esteva (Spain), 25 years old  
Education: Chemical Engineer

– You have to be proactive and open-minded as a newcomer and make it clear to your colleagues what you are able to cope. The pharmaceutical field is new to me. But busy as they are, most of my colleagues find the time to teach me, and they also trust me. Even though it was a bit hard at first, I can feel over time that I am beginning to be taken seriously and that my contribution is appreciated.



NNE Pharmaplan is the world's leading engineering and consultancy company focused entirely on the pharma and biotech industries. We employ more than 1500 people worldwide and offer global reach and local knowledge along with our all-encompassing list of services.  
[nnepharmaplan.com](http://nnepharmaplan.com)

nne pharmaplan®



**(i) Geometry**

Choose a scale to represent  $\underline{V}_1$  and  $\underline{V}_2$ , and draw a parallelogram.

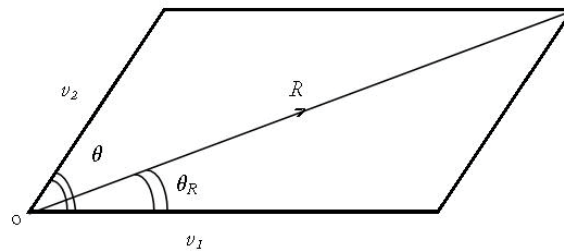

The long diagonal gives you  $\underline{R} = \underline{V}_1 + \underline{V}_2$

You can get magnitude of R by using a scale, and of course measure  $\Theta_R$  with a protractor.

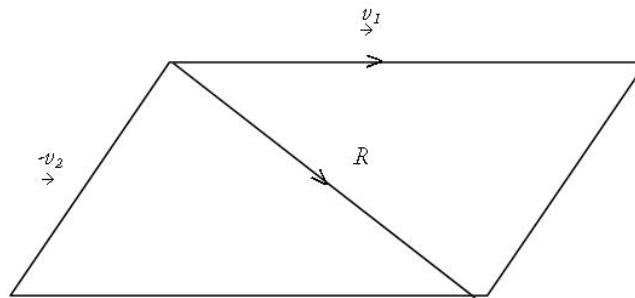

Also,

$$\underline{R} = \underline{V}_1 - \underline{V}_2$$

is determined by the short diagonal. Repeated application of this construct will allow you to add many vectors.

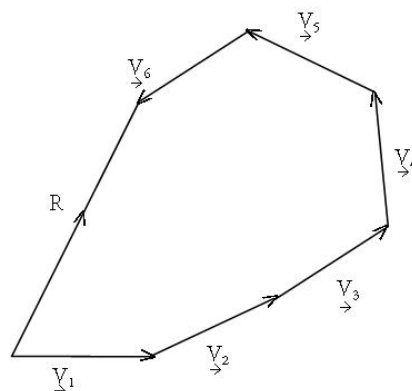

$$\underline{R} = \underline{V}_1 + \underline{V}_2 + \underline{V}_3 + \underline{V}_4 + \underline{V}_5 + \underline{V}_6$$

as the vector which connects the “tail of  $\underline{V}_1$  to the head of  $\underline{V}_6$  .

Further, it immediately follows that if all the vectors are parallel to one another

$$\begin{aligned}\underline{R} &= V_1\hat{d} + V_2\hat{d} + V_3\hat{d} - V_4\hat{d}\dots \\ &= (V_1 + V_2 + V_3 - V_4 + \dots)\hat{d}\end{aligned}$$

**(ii) Algebra/ Trig.**

We want to calculate R, so as shown drop a  $\perp$  from C to  $\Delta A$  extended. Clearly,

$$\begin{aligned}\frac{CD}{V_2} &= \text{Sin}\Theta \\ \frac{AD}{V_2} &= \text{Cos}\Theta\end{aligned}$$

using Pythagoras' Theorem

$$\begin{aligned}R^2 &= OD^2 + CD^2 \\ &= (V_1 + V_2\text{Cos}\Theta)^2 + (V_2\text{Sin}\Theta)^2 \\ &= V_1^2 + V_2^2\text{Cos}^2\Theta + 2V_1V_2\text{Cos}\Theta + V_2^2\text{Sin}^2\Theta\end{aligned}$$

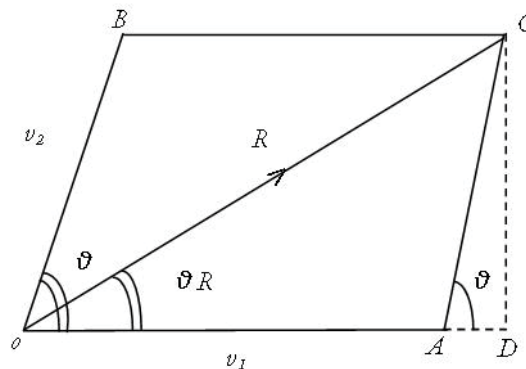

That is

$$R = \sqrt{V_1^2 + V_2^2 + 2V_1V_2\text{Cos}\Theta} \quad [2]$$

Also

$$\tan \Theta_R = \frac{CD}{OD} = \frac{V_2\text{Sin}\Theta}{V_1 + V_2\text{Cos}\Theta} \quad [3]$$

So indeed we have determined both the magnitude [Eq2] and direction [Eq3] of the vector  $\underline{R} = (\underline{V}_1 + \underline{V}_2)$

Again, if we have more than 2 vectors we can use Eq. [2] and [3] repeatedly to arrive at  $\underline{R} = \underline{V}_1 + \underline{V}_2 + \underline{V}_3 + \dots$

**(iii) The Method of Components**

This is the most elegant procedure for adding (or subtracting) many vectors.

We begin by defining that the component of a vector  $\underline{V}$  along any direction  $\hat{d}$  is a **Scalar** quantity.

$$V_d = V \cos(\underline{V}, \hat{d})$$

That is,  $Vd = [\text{magnitude of } V] \times [\text{Cosine of angle between } \underline{V} \text{ and } \hat{d}]$

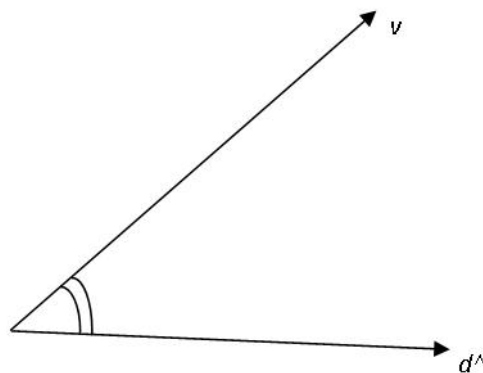

This e-book  
*is made with*  
**SetaPDF**



**SETASIGN**

PDF components for PHP developers

[www.setasign.com](http://www.setasign.com)



Let us put our vector  $\underline{V}$ . N.B. If light were in the x-y coordinate falling straight down system and we see  $V_x$  would be the immediately that: “shadow” of V along x.

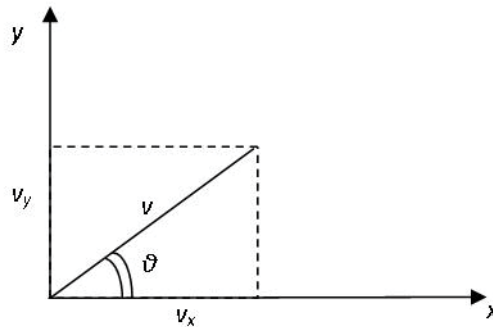

$$V_x = V \cos \Theta$$

$$V_y = V \cos(90 - \Theta) = V \sin \Theta$$

and clearly  $V = \sqrt{V_x^2 + V_y^2}$

or  $\underline{V} = V_x \hat{x} + V_y \hat{y}$

$$\tan \Theta = \frac{V_y}{V_x}$$

This tells us that a vector can be specified either by writing magnitude (V) and direction ( $\vartheta$ ) or by writing the magnitudes of its components.

So now if we have many vectors:

$$\underline{V}_1 = V_{1x} \hat{x} + V_{1y} \hat{y}$$

$$\underline{V}_2 = V_{2x} \hat{x} + V_{2y} \hat{y}$$

$$\underline{V}_i = V_{ix} \hat{x} + V_{iy} \hat{y}$$

$$\underline{R} = \underline{\Sigma V}_i = \Sigma V_{ix} \hat{x} + \Sigma V_{iy} \hat{y} \quad \rightarrow [4]$$

$$= R_x \hat{x} + R_y \hat{y} \quad \rightarrow [4']$$

and hence  $R = \sqrt{R_x^2 + R_y^2}$  [5]

$$\tan \theta_R = \frac{R_y}{R_x} \quad [6]$$

where  $\Theta_r$  is the angle between  $\underline{R}$  and  $\hat{x}$ .



### TRIG IDENTITIES

Take two unit vectors  $\hat{V}_1$  and  $\hat{V}_2$   
making angles  $\vartheta_1$  and  $\vartheta_2$  with  
the axis of  $x$  as shown.

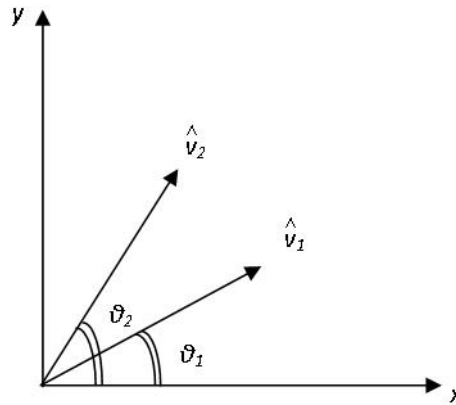

$$\underline{R} = \hat{V}_1 + \hat{V}_2$$

From Eq(1)  $R = \sqrt{1 + 1 + 2\cos(\Theta_2 - \Theta_1)}$  [7]

Also

$$\hat{V}_1 = \cos\Theta_1\hat{x} + \sin\Theta_1\hat{y}$$

$$\hat{V}_2 = \cos\Theta_2\hat{x} + \sin\Theta_2\hat{y}$$

so  $R_x = (\cos\Theta_1 + \cos\Theta_2)$

$$R_y = (\sin\Theta_1 + \sin\Theta_2)$$

$$\begin{aligned} R &= \sqrt{(\cos\Theta_1 + \cos\Theta_2)^2 + (\sin\Theta_1 + \sin\Theta_2)^2} \\ &= \sqrt{\cos^2\Theta_1 + \cos^2\Theta_2 + 2\cos\Theta_1\cos\Theta_2 + \sin^2\Theta_1 + \sin^2\Theta_2 + 2\sin\Theta_1\sin\Theta_2} \\ &= \sqrt{1 + 1 + 2[\cos\Theta_1\cos\Theta_2 + \sin\Theta_1\sin\Theta_2]} \end{aligned} \quad [8]$$

Compare Eqs [7] and [8] and you get the trig identity:

$$\cos(\Theta_1 - \Theta_2) = \cos\Theta_1\cos\Theta_2 + \sin\Theta_1\sin\Theta_2 \rightarrow I_1$$

Next, let  $\Theta_1 = (\frac{\pi}{2} - \Theta_3)$

$$\begin{aligned}\cos(\frac{\pi}{2} - \Theta_3 - \Theta_2) &= \sin(\Theta_3 + \Theta_2) \\ &= \cos(\frac{\pi}{2} - \Theta_3)\cos\Theta_2 + \sin(\frac{\pi}{2} - \Theta_3)\sin\Theta_2\end{aligned}$$

Which gives another identity

$$\sin(\Theta_3 + \Theta_2) = \sin\Theta_3\cos\Theta_2 + \cos\Theta_3\sin\Theta_2 \rightarrow I_2$$

if in  $I_1$  you put  $\Theta_4 = -\Theta_2$  and remember that

$$\sin(-\Theta) = -\sin\Theta$$

you get

$$\cos(\Theta_1 + \Theta_4) = \cos\Theta_1\cos\Theta_4 - \sin\Theta_1\sin\Theta_4 \rightarrow I_3$$

and similarly

$$\sin(\Theta_3 - \Theta_5) = \sin\Theta_3\cos\Theta_5 - \sin\Theta_5\cos\Theta_3 \rightarrow I_4$$



"I studied English for 16 years but...  
...I finally learned to speak it in just six lessons"  
Jane, Chinese architect

ENGLISH OUT THERE

Click to hear me talking before and after my unique course download

# 7 Kinematics – Two Dimensions – Projectile Motion

At  $t = 0$  a projectile is launched from the origin ( $x_i = 0, y_i = 0$ ) with a velocity of  $v_i$  m/sec at angle of  $\Theta_i$  above the horizon (x-axis). What are the equations which describe its motion in the xy-plane? It is best to write down the components and then the vectors.

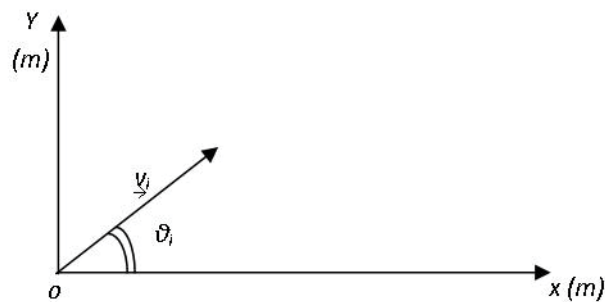

	<b>x-component</b>	<b>y-component</b>	<b>Vector</b>
Acceleration	0	$9.8m/sec^2$	$\underline{a} = 0\hat{x} - 9.8m/s^2\hat{y}$ → (1)
Velocity	$v_i \cos \Theta_i$	$v_i \sin \Theta_i - 9.8t$	$\underline{v} = (v_i \cos \Theta_i)\hat{x} + (v_i \sin \Theta_i - 9.8t)\hat{y}$ → (2)
Position	$(v_i \cos \Theta_i) t$	$(v_i \sin \Theta_i) t - 4.9t^2$	$\underline{r} = (v_i \cos \Theta_i)t\hat{x} + [(v_i \sin \Theta_i)t - 4.9t^2]\hat{y}$ → (3)

We can also write for the y-velocity

$$v_y^2 = (v_i \sin \Theta_i)^2 - 19.6y \quad \rightarrow (4)$$

and we use Eq(4) when  $t$  is not known.

## Questions

1. What is its path in the xy-plane as we saw the parabola in the water stream. To derive it note that

$$y = (v_i \sin \Theta_i)t - 4.9t^2$$

and  $x = (v_i \cos \Theta_i)t$

so one can write

$$y = \frac{(v_i \sin \Theta_i)x}{(v_i \cos \Theta_i)} - 4.9 \left( \frac{x}{v_i \cos \Theta_i} \right)^2$$

$$= x \tan \Theta_i - 4.9 \left( \frac{x^2}{v_i \cos \Theta_i} \right) \quad \rightarrow (5)$$

This is a very useful equation. Do not need to know  $t$ , relates  $y$  to  $x$  and  $v_i$ . See plot along side. It helps to define two quantities

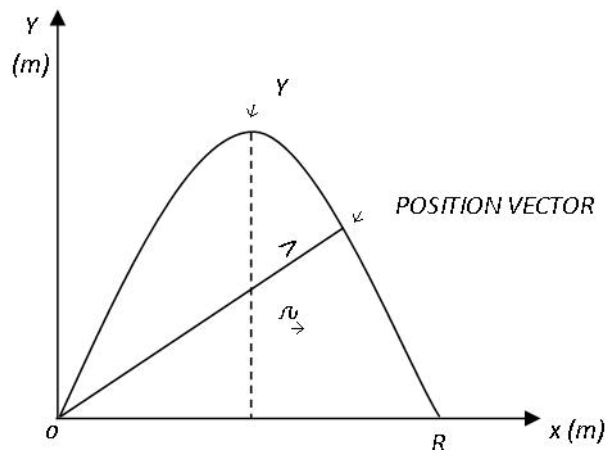

$y_{top}$  = highest point during flight

$R$  = range; distance travelled before returning to Earth.

2. Why does it stop rising? Because the  $y$  velocity goes to zero. Using Eq(4) we write

$$y_{top} = \frac{v_i^2 \sin^2 \Theta_i}{19.6} \quad \rightarrow (6)$$

3. What is its acceleration while it is in the air? At all points  $y \neq 0$

$$\rightarrow \underline{a} = -9.8m/s^2 \hat{y} \quad \leftarrow !$$

fixed by the Earth.

4. Velocity at  $y_{top}$ ,  $v_y = 0$ ,  $v_x = v_i \cos \Theta_i$

$$\underline{v} = (v_i \cos \Theta_i) \hat{x} + 0 \hat{y}$$

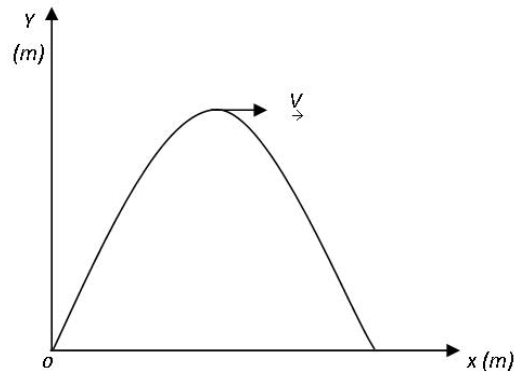

5. When does it get to  $y_{top}$ ?  $v_y = 0$  there

So we use

$$v_y = v_i \sin \Theta_i - 9.8t$$

And get

$$t_{top} = \frac{v_i \sin \Theta_i}{9.8} \quad \rightarrow (7)$$



## Sharp Minds - Bright Ideas!

Employees at FOSS Analytical A/S are living proof of the company value - First - using new inventions to make dedicated solutions for our customers. With sharp minds and cross functional teamwork, we constantly strive to develop new unique products - Would you like to join our team?

FOSS works diligently with innovation and development as basis for its growth. It is reflected in the fact that more than 200 of the 1200 employees in FOSS work with Research & Development in Scandinavia and USA. Engineers at FOSS work in production, development and marketing, within a wide range of different fields, i.e. Chemistry, Electronics, Mechanics, Software, Optics, Microbiology, Chemometrics.

**We offer**  
*A challenging job in an international and innovative company that is leading in its field. You will get the opportunity to work with the most advanced technology together with highly skilled colleagues.*

*Read more about FOSS at [www.foss.dk](http://www.foss.dk) - or go directly to our student site [www.foss.dk/sharpminds](http://www.foss.dk/sharpminds) where you can learn more about your possibilities of working together with us on projects, your thesis etc.*

The Family owned FOSS group is the world leader as supplier of dedicated, high-tech analytical solutions which measure and control the quality and production of agricultural, food, pharmaceutical and chemical products. Main activities are initiated from Denmark, Sweden and USA with headquarters domiciled in Hillerød, DK. The products are marketed globally by 23 sales companies and an extensive net of distributors. In line with the corevalue to be 'First', the company intends to expand its market position.



**Dedicated Analytical Solutions**

FOSS  
 Slangerupgade 69  
 3400 Hillerød  
 Tel. +45 70103370  
[www.foss.dk](http://www.foss.dk)



6. When does it return to ground ( $y = 0$ )?

Use  $y = (v_i \sin \Theta_i)t - 4.9t_{gr}^2$

So

$$0 = (v_i \sin \Theta_i)t_{gr} - 4.9t_{gr}^2$$

$$t_{gr} = \frac{v_i \sin \Theta_i}{4.9} = 2t_{top} \quad \rightarrow (8)$$

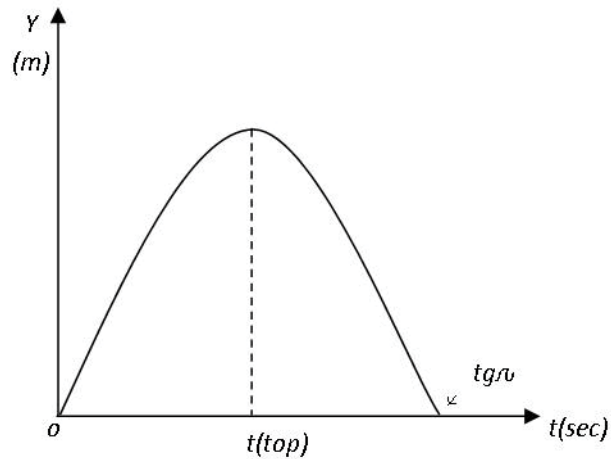

7. What is its velocity just before it hits ground

$$v_x = v_i \cos \Theta_i$$

$$v_y = v_i \cos \Theta_i - 2 \frac{v_i \sin \Theta_i}{9.8} \times 9.8$$

$$= -v_i \sin \Theta_i$$

$$\text{Hence } \underline{v} = (v_i \cos \Theta_i)\hat{x} - (v_i \sin \Theta_i)\hat{y} \quad \rightarrow (9)$$

That is, x-component of velocity is same as at the start, y-component is reversed.

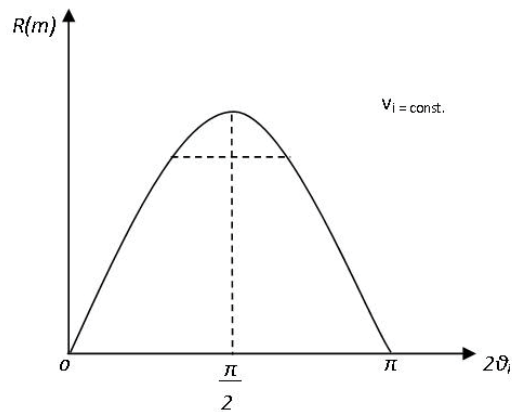

8. What is the range?

$$x = (v_i \cos \Theta_i)t$$

And to get to  $R$

$$\begin{aligned}
 t = t_g &= \frac{2v_i \sin \Theta_i}{9.8} \\
 R &= \frac{(v_i \cos \Theta_i)(2v_i \sin \Theta_i)}{9.8} \\
 &= \frac{v_0^2 \sin 2\Theta_i}{9.8} \qquad \rightarrow (10)
 \end{aligned}$$

9. For a given  $v_i$  what launch angle will give you maximum range  $R$ ?  
(Galileo's findings)

Eq(10) says

$$R = \frac{v_0^2 \sin 2\Theta_i}{9.8}$$

Maximum value of  $\sin 2\Theta_i = 1$  when  $2\Theta_i = \frac{\pi}{2}$ . Hence maximum range when  $\Theta_i = 45^\circ$ . Also, note that there are two angles for which  $R$  is the same.

$$2\Theta_2 = \frac{\pi}{2} + \alpha$$

$$2\Theta_1 = \frac{\pi}{2} - \alpha$$

$$\Theta_1 + \Theta_2 = \frac{\pi}{2}$$

So  $\Theta_1$  and  $\Theta_2$  are complementary angles.

10. What happens if projectile is launched at  $x = 0$ ,  $y = y_i$ . In that case

$$y_{top} = y_i + \frac{v_i^2 \sin^2 \Theta_i}{19.6}$$

and  $R$  is obtained by solving the quadratic equation

$$0 = y_i + R \tan \Theta_i - 4.9 \left( \frac{R^2}{v_i^2 \cos^2 \Theta_i} \right)$$

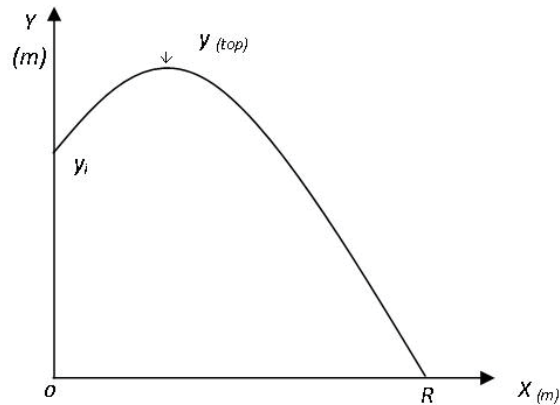

$$R = \frac{-v_i^2 \sin \Theta_i \cos \Theta_i \pm v_i \cos \Theta_i \sqrt{v_i^2 \sin^2 \Theta_i + 19.6 y_i}}{-9.8}$$

Not surprisingly, the projectile travels farther before returning to ground. This is what led Newton to suggest that if one goes high up and uses a large enough initial speed one can get the projectile to go around the Earth.



## 8 Relative Velocities – Inertial Observers

Now that we have developed the kinematic Eqs.

$$\underline{a} = a\hat{x}$$

$$\underline{V} = (V_0 + at)\hat{x}$$

$$\underline{x} = (x_0 + V_0t + \frac{1}{2}at^2)\hat{x}$$

we know that given a clock (to measure  $t$ ) and two meter scales (to measure  $x$  and  $y$ ) we can describe any constant acceleration motion precisely. Since there are many, many observers, the question arises, how do two observers relate their observations of the same motion if the observers are **not** at rest with respect to one another.

**gaieteye**<sup>®</sup>  
*Challenge the way we run*

**EXPERIENCE THE POWER OF  
FULL ENGAGEMENT...**

.....

**RUN FASTER.  
RUN LONGER..  
RUN EASIER...**

**READ MORE & PRE-ORDER TODAY  
WWW.GAITEYE.COM**

For example, Sam is standing on the shore while Sally is floating along with the water on a river. With a velocity

$$\underline{V}_R = V_R \hat{x}$$

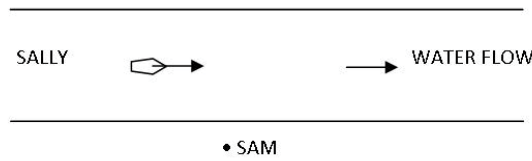

OR Chris's is standing on the ground and Crystal comes along on a roller skate travelling at  $\underline{V}_R = V_R \hat{x}$

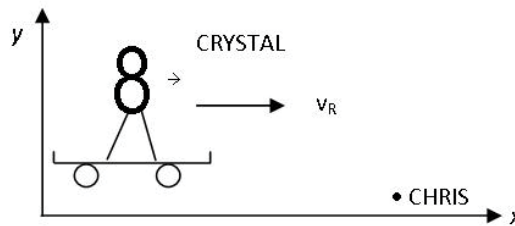

or you are standing on the ground and a helicopter hovers overhead while the wind is blowing at vel.  $\underline{V}_R = V_R \hat{x}$

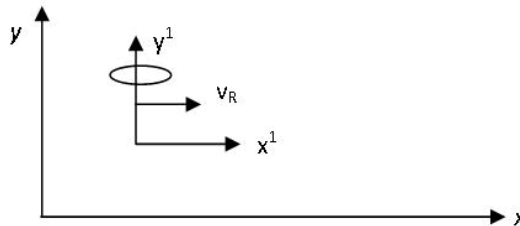

We must learn how to relate observations made by you  $[x,y,t]$  with observations made by an observer  $[x',y',t']$  moving with respect to you at velocity  $\underline{V}_R$ .

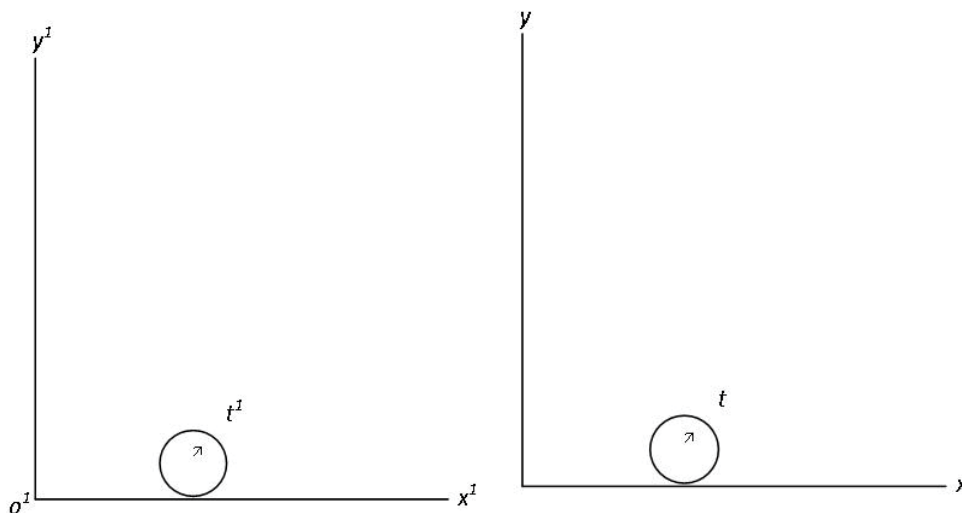

Step 1: We arrange that at the instant your origins coincide ( $0$  and  $0'$  same), both start your clocks, that will ensure that  $t' = t$ .

Now consider a time  $t$  later

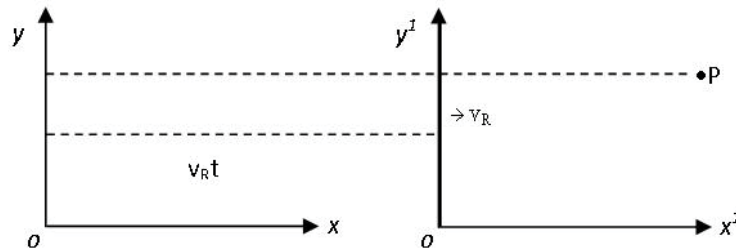

At  $t$  an event occurs at  $p$ :

You measure	She measures
$x, y, t$	$x', y', t'$

and you can see that

$$t' = t$$

$$y' = y$$

$$x' = x - v_R t$$

**The Wake**  
the only emission we want to leave behind

Low-speed Engines Medium-speed Engines Turbochargers Propellers Propulsion Packages PrimeServ

The design of eco-friendly marine power and propulsion solutions is crucial for MAN Diesel & Turbo. Power competencies are offered with the world's largest engine programme – having outputs spanning from 450 to 87,220 kW per engine. Get up front! Find out more at [www.mandieselturbo.com](http://www.mandieselturbo.com)

Engineering the Future – since 1758.  
**MAN Diesel & Turbo**

Click on the ad to read more

If now P has a displacement you measure  $\Delta x$ ,  $\Delta t$  she measures  $\Delta x'$ ,  $\Delta t' = \Delta t$

so

$$\Delta x' = \Delta x - V_R \Delta t$$

and dividing by  $\Delta t$  and making it small we see that

$$\underline{V}' = \underline{V} - \underline{V}_R \quad \text{_____I}$$

This equation is very useful for solving all the “relative velocity” problems:

**EX1: Boat in River**

$$\underline{V}_R = \underline{V}_{WS} \quad \text{velocity of water with respect to shore}$$

$$\underline{V}' = \underline{V}_{BW} \quad \text{Velocity of Boat with respect to water}$$

$$\underline{V} = \underline{V}_{BS} \quad \text{Velocity of Boat with respect to shore}$$

$$\underline{V}_{BS} = \underline{V}_{BW} + \underline{V}_{WS}$$

**EX2: Airplane**

$$\underline{V}' = \underline{V}_{PA} \quad \text{[Velocity of plane wrt air]}$$

$$\underline{V}_R = \underline{V}_{AG} \quad \text{[Velocity of air wrt ground]}$$

$$\underline{V} = \underline{V}_{PG} \quad \text{[Velocity of plane wrt ground]}$$

$$\underline{V}_{PG} = \underline{V}_{PA} + \underline{V}_{AG}$$

**EX3: Velocity observed by person standing on ground**

$$\underline{V} = \underline{V}' + \underline{V}_R$$

However, Eq I has more profound consequences.

Suppose that P also has an acceleration.

$$\text{Since } \underline{V}_R = \text{Constant}$$

$$\Delta \underline{V}' = \Delta \underline{V}$$

$$\text{so } \underline{a}' = \underline{a}$$

This allows us to define an Inertial observer as one whose coordinate system moves at a constant velocity (vector) = constant. Magnitude, no change in direction.

**This has two major consequences:**

**A:** Principle of Relativity: LAWS OF PHYSICS ARE THE SAME FOR ALL INERTIAL OBSERVERS. (FULL SIGNIFICANCE OF THIS BECOMES CLEAR AFTER WE INTRODUCE NEWTON'S LAW WHICH MANDATES THAT IF  $\underline{a} \neq 0$  THERE MUST BE A FORCE PRESENT AT THAT POINT AT THAT TIME.

**B:** No experiment done **within** a SYSTEM CAN DISCOVER THAT THE SYSTEM IS MOVING AT A UNIFORM VELOCITY. (This is the basis for the popular statement, all motion is relative. Now we know that the more precise statement should be all uniform motion ( $\underline{V}_R = \text{const.}$ ) is relative.)

I joined MITAS because  
I wanted **real responsibility**

The Graduate Programme  
for Engineers and Geoscientists  
[www.discovermitas.com](http://www.discovermitas.com)

**Month 16**  
I was a construction  
supervisor in  
the North Sea  
advising and  
helping foremen  
solve problems

Real work  
International opportunities  
Three work placements



# 9 Newton's Laws (Point Objects)

**FIRST** OBJECTS DO NOT CHANGE THEIR STATE OF MOTION (vel.  $\underline{v}$  For Now)  
SPONTANEOUSLY

DEFINES INERTIA

Examples: SEAT BELTS, STUMBLE, GRASS MOWING

**SECOND** a) EVERY OBJECT HAS AN INTRINSIC PROPERTY CALLED INERTIAL MASS (M)  
b) AN OBJECT OF MASS M CAN HAVE A NON-ZERO ACCELERATION IF AND ONLY IF THERE IS A FORCE  $\underline{F}$  PRESENT SUCH THAT

$$M \underline{a} = \underline{F}$$

COROLLARIES: (i) IF AN OBJECT IS IN EQUILIBRIUM ( $\equiv m$ ) ( $\underline{a} = 0$ ), THE VECTOR SUM OF ALL THE FORCES ACTING ON IT MUST BE **ZERO**

$$\underline{F}_1 + \underline{F}_2 + \underline{F}_3 \dots = 0$$

Object does not have to be at rest, it must not change  $\underline{v}$ .

(ii) IF  $\underline{a} \neq 0$  at a SPACE POINT AT A TIME t, THERE MUST BE A FORCE ACTING AT THE **PT** AT THAT TIME.

**THIRD** WHEN TWO OBJECTS INTERACT THE FORCES ACTING ON THEM FORM ACTION-REACTION PAIRS ( $\underline{F}_{21}$  acts on object 1,  $\underline{F}_{12}$  on object 2)

$$\underline{F}_{21} = -\underline{F}_{12}$$

## FORCES

In order to use Newton's Laws we need the Forces that occur in various physical systems. For our discussion in I we deal with Mechanical Forces only. Also, we do not discuss in detail the origin of the force in Every Case.

### 1. WEIGHT

Near Earth Every unsupported object has an acceleration

$$\underline{a} = -9.8m/s^2 \hat{y} = -g\hat{y}$$

So it must experience a force

$$\underline{w} = -9.8M\hat{y} = -Mg\hat{y}$$

where  $M$  is its mass. This force is weight and is a vector perpendicular to the Earth's surface directed toward the center of the Earth. More precisely, since the Earth is a sphere the force should be written as

$$\underline{w} = -9.8M\hat{r}$$

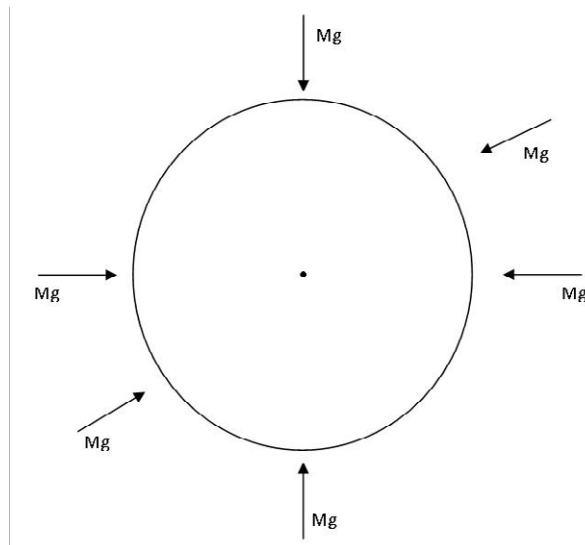

where  $\hat{r}$  is a unit vector along the radius. It is a manifestation of Newton's universal law of Gravitation (discussed in detail later)

$$\underline{F}_G = -\frac{GM_E M}{R_E^2} \hat{r}$$

where  $M_E$  = Mass of Earth

$R_E$  = Radius of Earth

$$G = 6.7 \times 10^{-11} \frac{N \cdot m^2}{(kg)^2}$$

By Newton's 3<sup>rd</sup> law it follows that the reaction force to  $\underline{w}$  acts at the center of the Earth

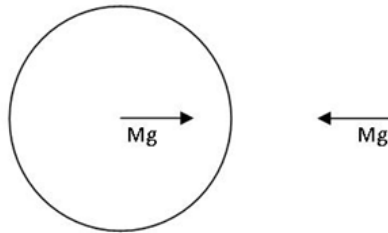

So Earth pulls on M, M pulls on Earth with an Equal and opposite force.

## 2. CONTACT FORCE OR NORMAL FORCE

Comes into play when an object is in contact with the surface of a solid. It acts perpendicular to surface of the solid: hence Normal Force ( $N_R$ ). It comes about because the atoms/molecules of a solid oppose the attempt by any foreign object to enter the solid. For example, put the mass M of the above discussion on the Earth. Now M is in  $\equiv m$  so the sum of the forces acting on it must be zero.

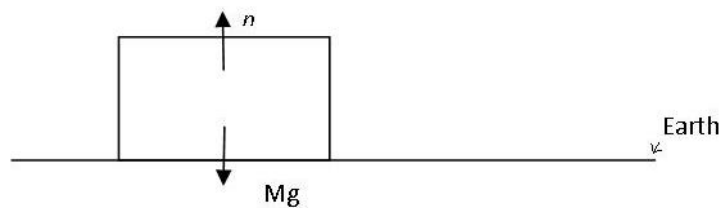

$$\underline{n} = n\hat{y}$$

$$\underline{w} = -Mg\hat{y}$$

$$\underline{n} + \underline{w} = 0$$

$$\underline{n} = -Mg\hat{y}$$

**Ex 2**  $M_1$  and  $M_2$  are lying on a smooth horizontal surface. Apply a force  $\underline{F} = F\hat{x}$  to  $M_1$  as shown. Both  $M_1$  and  $M_2$  acquire an acceleration

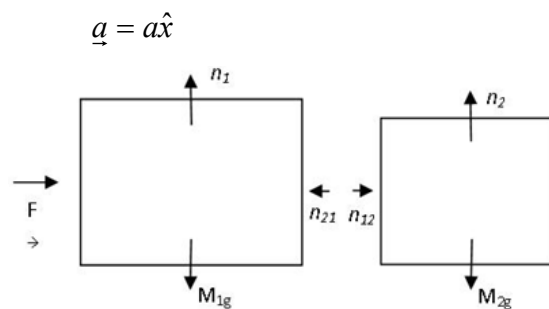



**Question:** Which force causes  $M_2$  to accelerate?

**Answer:** Contact force between  $M_1$  and  $M_2$ .

Let us draw all the forces acting on each mass (Free Body diagrams)

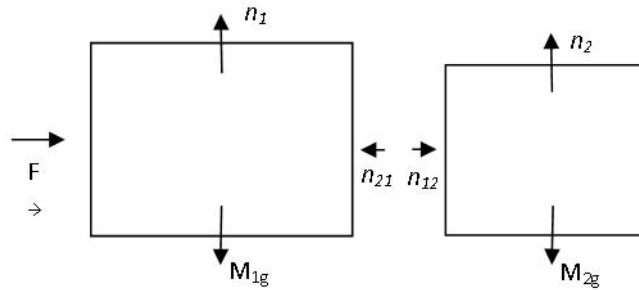

By the 3<sup>rd</sup> law  $\underline{n_{12}} + \underline{n_{12}} = 0$

$$(n_{12} + n_{12})\hat{x} = 0$$

To calculate  $\underline{a}$  we must use force acting at that mass at that time so

$$M_1 \underline{a} = \underline{F} + \underline{n_2} = F\hat{x} - n_2 \hat{x}$$

$$M_2 \underline{a} = \underline{n_2} = n_2 \hat{x}$$

www.job.oticon.dk

**oticon**  
PEOPLE FIRST



Add

$$\begin{aligned}(M_1 + M_2)\underline{a} &= F\hat{x} + (n_2 - n_1)\hat{x} \\ &= F\hat{x} \\ \underline{a} &= \left(\frac{F}{M_1 + M_2}\right)\hat{x}\end{aligned}$$

**EX 3** To weigh yourself you stand on a weighing machine. You have two forces acting on you  $\underline{w} = -Mg\hat{y}$  and  $\underline{n} = n\hat{y}$  the normal force which the machine exerts on you. You are in  $\equiv m$  so  $n = Mg$ . You push down on machine with  $\underline{n} = -n\hat{y}$  so machine records  $n$  and hence  $w$ .

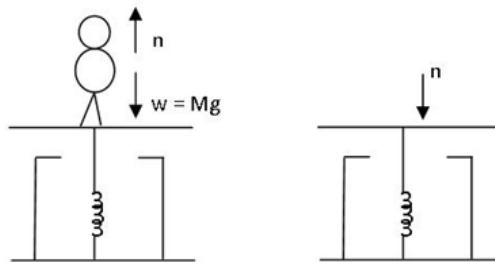

**EX 4** If the surface is not horizontal  $\underline{n}$  will have to adjust so that there is  $\equiv m$  perpendicular (normal) to the surface while there is acceleration  $g \sin \Theta$  down the ramp. The force picture is

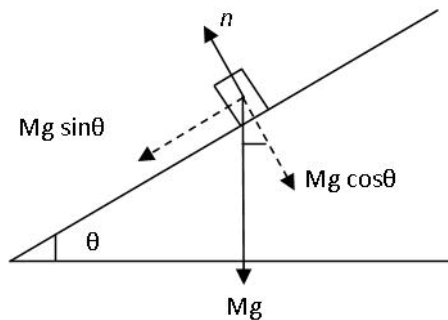

$\perp$  to surface there is  $\equiv m$  so

$$n - Mg \cos \Theta = 0; \quad n = Mg \cos \Theta$$

$\parallel$  to surface there is acceleration caused by  $Mg \sin \Theta$

Not surprisingly  $\underline{n}$  is maximum when  $\Theta = 0$  (horizontal surface) and goes to zero when  $\Theta = \frac{\pi}{2}$  (surface is vertical)

**EX 5** Another way to change  $n$  is to apply a force  $\underline{F}$  at an angle  $\Theta$  above the x-axis. Now for  $\equiv m$  along y we have

$$n + F \sin \Theta - Mg = 0$$

so 
$$n = Mg - F \sin \Theta$$

while along x there is acceleration given by

$$M \underline{a} = F \cos \Theta \hat{x}$$

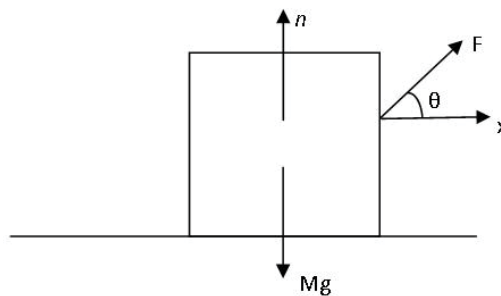

### 3. TENSION IN A MASSLESS, INEXTENSIBLE STRING

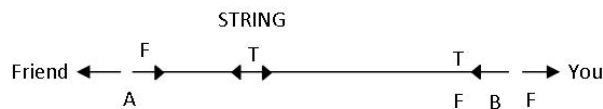

You are holding one end of a light string. Your friend catches hold of the other end. Suppose she pulls on it with a force  $\underline{F} = -F\hat{x}$ , toward the left. In order to keep it in  $\equiv m$  you have to pull on the right with  $\underline{F} = +F\hat{x}$ . How come? Well, when she applied  $-F\hat{x}$  at A and the string wants to be in  $\equiv m$  it must develop  $+F\hat{x}$  at A, again to keep  $\equiv m$  everywhere inside, it needs  $\underline{F}$ 's at every point balancing each other out until point B is reached where string pulls to the left. So for  $\equiv m$  at B you must pull with  $+F\hat{x}$ . A force  $\underline{F}$  applied at one end of the string causes a tension  $T = F$  to appear in the string such that at the ends  $\underline{T}$  acts toward the middle and at the middle  $\underline{T}$  is directed toward the ends.

### 4. SPRING FORCE (HOOKE'S LAW)

This force appears if you stretch a spring or squeeze it. The spring resists the change in its length so this force always oppose the stretch (or squeeze). For small changes in length the force is proportional to the change in length hence we write

$$\underline{F}_{SP} = -k(\Delta x)\hat{x}$$

where  $\Delta x =$  change in length  
 $k =$  spring constant

Minus sign ensures that  $\underline{F}_{SP}$  is opposite to  $\underline{\Delta x} = \Delta x \hat{x}$ .

So if  $k = 10^4 N/m$ , it will cost you 10N of force to change its length by 1mm.

## 5. FRICTION

This force arises because surfaces of solids are never totally smooth so when two surfaces are made to slide past one another they resist it by developing the force of friction. Indeed, as we will find in the experiment sketched below if the applied force is less than a certain value no motion occurs and we talk of static friction ( $f_s$ ). Once  $F_{app}$  exceeds  $\mu_s N_R$  motion ensues and we get kinetic friction  $f_k$ .

Note: friction always opposes motion

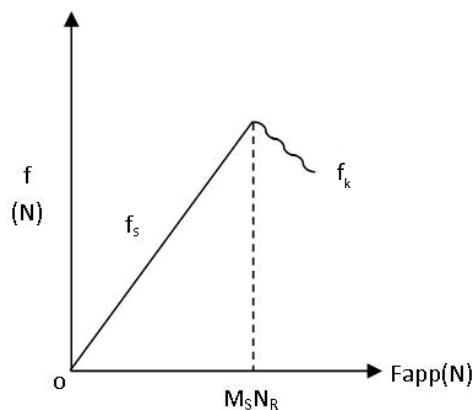
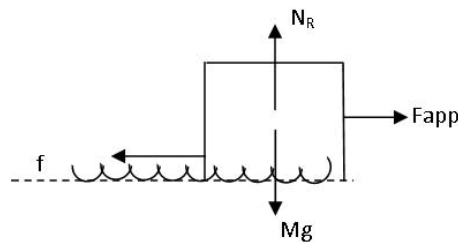

To be precise, we slowly increase  $F_{app}$  and since no motion occurs we say  $\underline{f}_s = -F_{app}$ . That means that as long as there is no motion  $f$  vs.  $F_{app}$  forms a straight line of slope 1. Finally, sliding starts because  $f_s$  has a maximum value. That is

$$f_s \leq (\mu_s N_R)$$

$$\underline{f}_s \perp \underline{N}_R$$

where  $\mu_s$  is called coefficient of static friction.  $\mu_s$  is determined by the properties of the two surfaces. If  $f_{app} > \mu_s N_R$ , sliding begins but frictional force is **NOT** zero. It is given by

$$f_k = \mu_k N_R$$

$\mu_k$  is called coefficient of kinetic friction.

**Note:**  $\vec{f} \perp \vec{N}_R$ ,  $\vec{f}$  always opposes  $\vec{F}_{applied}$

Dependence on  $N_R$  is eminently reasonable because the larger the  $N_R$  the more tightly the two surfaces are “meshed” together.

# INNOVATIVE LIKE YOU.

If you're hoping for a truly modern education, one where you're encouraged to speak your mind and to think long-term, both when it comes to your own future and the future of the planet. Then the University of Gothenburg is the place for you.

Study a Master's programme in Gothenburg, Sweden | [www.gu.se/education](http://www.gu.se/education)



# 10 Uniform Circular Motion – Kinematics and Dynamics

A particle is moving on a circle of radius  $R$  at a constant speed  $S$ . First, we begin by describing the motion precisely- kinematics. Let us put the circular orbit in the  $xy$ -plane with the center of the circle at  $x = 0$ ,  $y = 0$ . The very first quantity we define is the Period: Time taken to go around once,  $T$ .

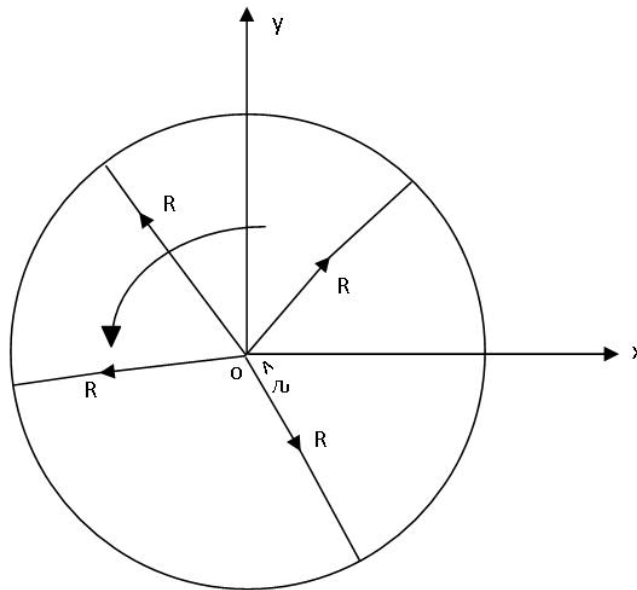

The speed can then be immediately written as:

$$S = \frac{2\pi R}{T}$$

As you can see when the particle moves around the circle, the radius rotates as a function of time. That is why it is customary to describe the motion in terms of

revolutions per sec ( $n_s$ ) so  $T = \frac{1}{n_s}$  sec

(*rps*)

or revolutions per minute ( $n_m$ ),

$$(rpm) \quad T = \frac{60}{n_m} \text{ sec}$$

For instance,  $15rpm$  means  $T=4sec$ .

Speed is an interesting concept but as before it is rather limiting. We need to look deeper.

**Position Vector:** We notice that the particle moves at fixed distance away from the center but the radius rotates. Hence, its position vector will be written as:

$$\underline{r} = R\hat{r} \quad \rightarrow (1)$$

where  $\hat{r}$  is a unit vector along the radius which rotates so as to go around once in time  $T$ .

**Velocity Vector:** Velocity is defined as rate of change of position vector so we need to find the displacement vector.

Consider a time interval  $\Delta t$  during which  $\hat{r}$  rotates by angle  $\Delta\theta$ .

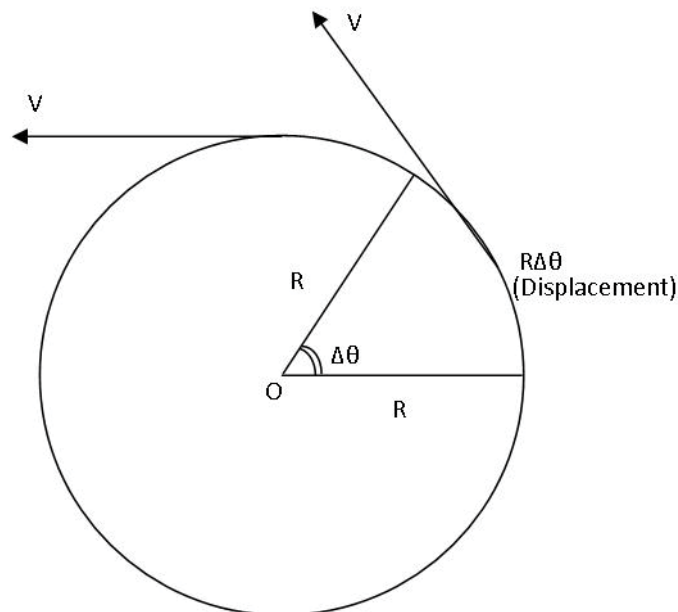

displacement during  $\Delta t$  is  $R\Delta\theta$  so magnitude of instantaneous velocity is

$$V = \frac{R\Delta\theta}{\Delta t} \quad (\Delta t \rightarrow 0)$$

Notice, direction of displacement is perpendicular to  $\hat{r}$  so direction of velocity is along the tangent to the circle. We define  $\hat{t}$  unit vector along tangent and write

$$\underline{V} = \frac{R\Delta\theta}{\Delta t} \hat{t}$$

We will soon introduce a formal definition for rate of change of angle with time, for now let us introduce as new symbol (greek letter omega)

$$\omega = \frac{\Delta\theta}{\Delta t}$$

and note  $\vec{v} = R\omega\hat{t}$

→ 2

and  $\hat{t}$  rotates with time

For uniform case rate of rotation is constant. So Eq(2) tells us that magnitude of  $V$  is constant.

**DIRECTION CHANGES!**

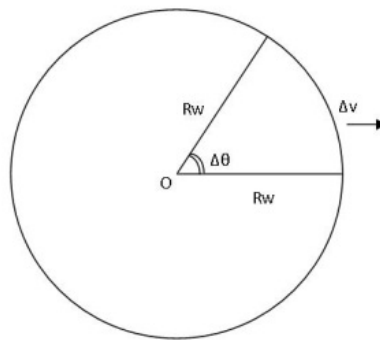



Linköping University –  
innovative, highly ranked,  
European

Interested in Computer Science? Kick-start your career  
with an English-taught master's degree.

→ [Click here!](#)









**Acceleration Vector:** Since the velocity vector is rotating the object has an acceleration. Again we need to calculate change in  $\underline{V}$  and divide by  $\Delta t$ . Change in magnitude of  $V$ :  $\Delta V = R\omega\Delta\theta$

So magnitude of acceleration is:

$$a = R\omega \frac{\Delta\theta}{\Delta t} = R\omega^2$$

and  $\underline{a}$  must be perpendicular to  $\hat{t}$ . If you look at the  $\underline{V}$  it is continuously turning TOWARD the center SO  $\underline{a}$  is along  $-\hat{r}$

SO  $\underline{a} = -R\omega^2\hat{r}$  &  $\hat{r}$  rotates

So  $\underline{a}$  is constant in magnitude but also rotates.

This is a special case so this acceleration has a special name: CENTRIPETAL ACCELERATION.

Finally we go back and look at

$$\omega = \frac{\Delta\theta}{\Delta t}$$

This is the rate at which the radius vector sweeps out an angle as it rotates so it is not surprising that we call it ANGULAR VELOCITY

Question? What is the direction of  $\underline{\omega}$ ?

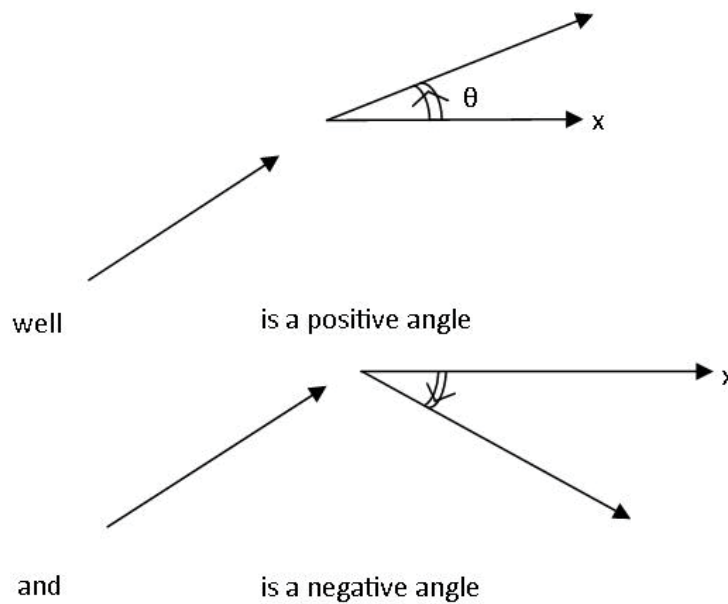

and rotation is about an axis perpendicular to 0 so it makes sense to say that is perpendicular to plane of circle. In our case circle is in xy-plane so.  $\vec{\omega} \parallel \pm \hat{z}$ .  $+\hat{z}$  for counter-clockwise (positive  $\mathcal{G}'s$ )  $-\hat{z}$  for clockwise (negative  $\mathcal{G}'s$ ). This is summarized by right-Hand Rule: Curl fingers of right hand along direction of motion on the circle, extend your thumb, it points in direction of

Table  $\rightarrow$  ANGULAR VELOCITY  $L^{\circ}T^{-1}$  rad/sec vector

So to summarize Kinematics:

**Position:**  $\underline{r} = R\hat{r}$  rotates by rad/sec (1)

**Velocity:** rotates by rad/sec (2)

**Centripetal Acceleration**

$$a_c = -R\omega^2\hat{r} = -\frac{v^2}{R}\hat{r} \quad (3)$$

rotates by rad/ sec

**angular velocity:**  $\vec{\omega} = \pm \frac{\Delta\theta}{\Delta t} \hat{z}$  (4) FIXED!

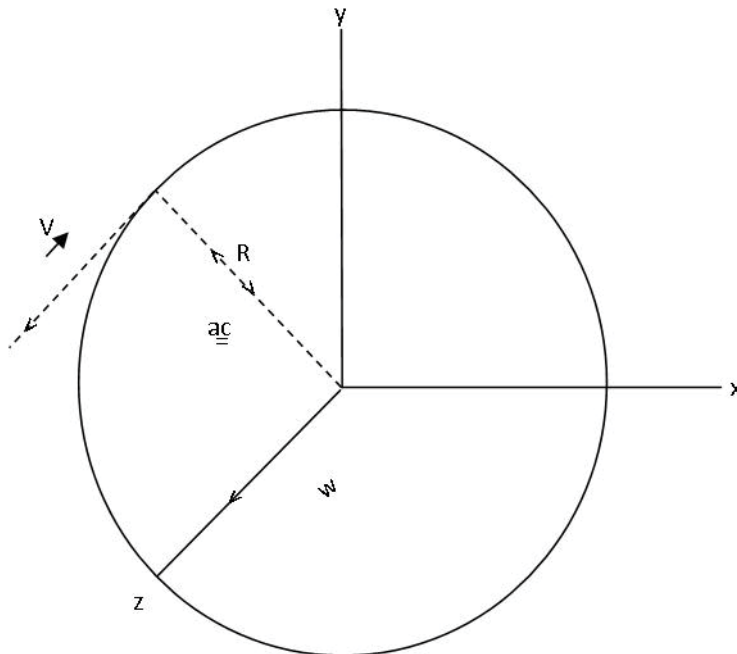

**Dynamics** A particle moving on a circle of radius  $R$  at a constant angular velocity  $\omega$  has a centripetal acceleration

$$\vec{a}_c = -R\omega^2 \hat{r} = -\frac{v^2}{R} \hat{r}$$

Newton's law  $M\vec{a} = \sum \vec{F}$  requires that for this motion to occur we must provide a

CENTRIPETAL FORCE  $\vec{F}_c = -MR\omega^2 \hat{r} = -\frac{Mv^2}{R} \hat{r} \rightarrow (5) \rightarrow (5)$

It is to be noted that  $\vec{F}_c$  must come from one or more of the available forces: Weight, normal force, tension, spring force, friction

NOTE:  $\vec{F}_c$  CANNOT BE DRAWN ON A DIAGRAM

**STUDY FOR YOUR MASTER'S DEGREE  
IN THE CRADLE OF SWEDISH ENGINEERING**

Chalmers University of Technology conducts research and education in engineering and natural sciences, architecture, technology-related mathematical sciences and nautical sciences. Behind all that Chalmers accomplishes, the aim persists for contributing to a sustainable future – both nationally and globally.

Visit us on [Chalmers.se](http://Chalmers.se) or **Next Stop Chalmers** on facebook.



**CHALMERS**  
UNIVERSITY OF TECHNOLOGY



Click on the ad to read more

# 11 Some Consequences of Earth's Rotation

The Earth is essentially a sphere of radius about 6400km which rotates about its axis once every 24 hours.  
So angular Velocity is:

$$\omega_E = \frac{2\pi}{24 \times 3600} \cong 7.3 \times 10^{-5} \text{ rad/s}$$

Choose CCW  $\vec{\omega}_E = +7.3 \times 10^{-5} \text{ rad/s} \hat{z}$

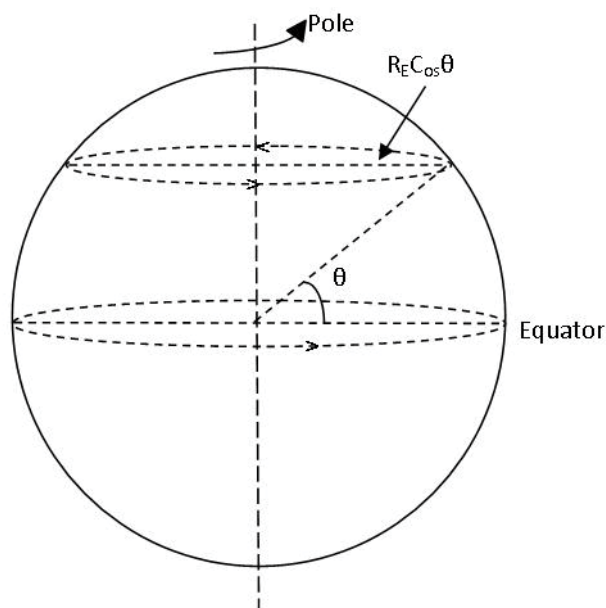

So every point on Earth is in uniform circular motion. At latitude  $\Theta$  the radius of the circle is  $R_E \cos \Theta$  so centripetal acceleration is

$$\vec{a}_c = -R_E \cos \Theta \omega_E^2 \hat{r}_\Theta$$

At the pole  $\Theta = \pi/2$ ,  $\vec{a}_c = 0$

At the equator  $\Theta = 0$ ,  $\vec{a}_c = -R_E \omega_E^2 \hat{r} \cong -0.03 \text{ m/s}^2 \hat{r}$

## So CONSEQUENCE I:

Our assumption that systems fixed with respect to Earth's surface are Inertial is **not** precisely correct; except at the Poles. The error is small because  $g = 9.8 \text{ m/s}^2$  but it is important.

**CONSEQUENCE II:**

The apparent weight is not the same at all  $\Theta$ . At the pole and at the equator the answer is simple because  $\underline{a}_c \parallel \underline{g}$  (both along radius of the Earth)

At the pole  $\underline{a}_c = 0 \quad N_R - Mg = 0 \quad N_R = Mg$

At the Equator  $(N_R - Mg)\hat{r} = -R_E \omega_E^2 \hat{r}$

So  $N_R = M(g - R_E \omega_E^2)\hat{r}$   
 $= M(9.8 - 0.03)m/s^2 \hat{r}$

weight is reduced by about 0.3%

**CONSEQUENCE III:**

This is the most subtle and happens for any  $\Theta$  other than 0 and  $\frac{\pi}{2}$  because  $\underline{a}_c$  is NOT parallel to  $\underline{g}$ .

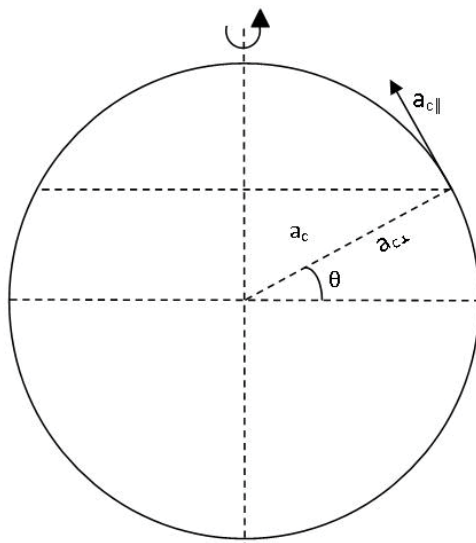

$$\underline{a}_c = -R_E \omega_E^2 \cos\theta \hat{r}_\theta$$

Indeed now  $\underline{a}_c$  has a component parallel to surface of Earth

$$a_{c\parallel} = R_E \omega_E^2 \sin\theta \cos\theta$$

and a component along radius of Earth

$$a_{c\perp} = -R_E \omega_E^2 \cos^2\theta \hat{r}$$

which is along  $r$  so it modifies "g" slightly.

Since we have an  $a_{c\parallel}$ , if you try to hang a pendulum, it cannot be vertical (parallel to  $\hat{r}$ ). It must tilt to yield a force to produce  $a_{c\parallel}$

$$\begin{aligned}\tan \delta &= \frac{a_{c\parallel}}{g} \\ &= \frac{\sin \Theta \cos \Theta R_E \omega_E^2}{g}\end{aligned}$$

$$\delta \rightarrow 0 \quad \Theta = 0 \quad \text{and} \quad \Theta = \pi/2$$

The situation is exactly like the case of a pendulum hanging in a cart which has an acceleration  $\underline{a} = -a\hat{x}$ .

$$-T \sin \Theta = -Ma$$

$$T \cos \Theta - Mg = 0$$

$$\tan \Theta = \frac{a}{g}$$

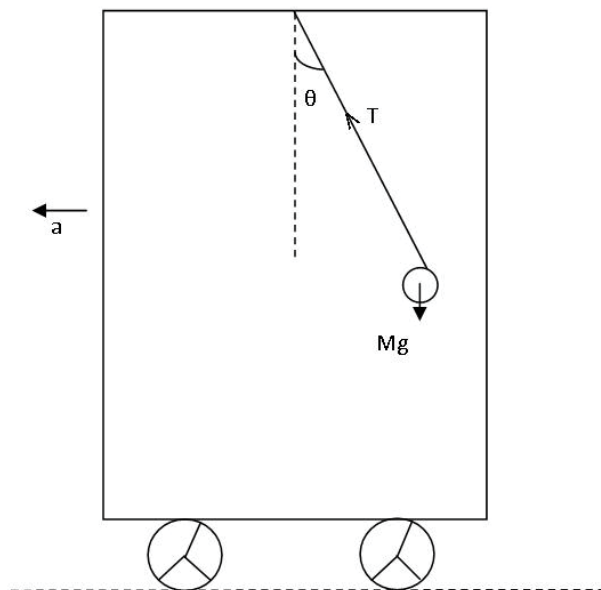

L,T,M

# 12 Universal Law of Gravitation – Force

Experimental facts which led to Newton's postulate.

1. Near Earth all unsupported objects have an acceleration

$$\underline{a} = -9.8 \frac{m}{s^2} \hat{r}$$

where  $\hat{r}$  is the unit vector along the radius of the Earth.

2. Kepler's laws of planetary motion around the Sun:

- i) Planets go around the sun in **PLANE** elliptical orbits with the sun being located at one focus of the Ellipse. Actually, in most cases the Ellipses are very close to being circles.

- ii) The period of a planet  $T_p$  is proportional to  $R_p^{3/2}$  where  $R_p$  is the semi-major axis of the Ellipse. That is

$$T_p^2 \propto R_p^3$$

- iii) The line connecting the planet's position to that of the Sun sweeps out equal areas in equal intervals of time.

Newton's solution developed in several steps.

**FIRST**

He postulated that if two point masses  $M_1$  and  $M_2$  are separated by a distance  $r$ , there exists a force between them given by the equation

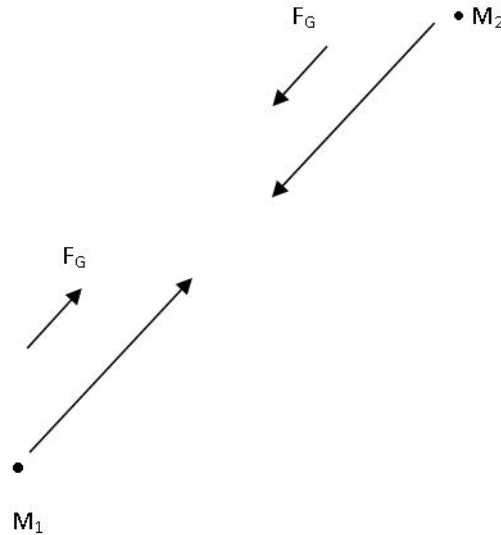

$$\vec{F}_G = -\frac{GM_1M_2}{r^2}\hat{r}$$

Where  $G$  is a universal constant. Now we know that the value of  $G$  is about

$$6.7 \times 10^{-11} \frac{N \cdot m^2}{(kg)^2}$$

$$[DIM : M^{-1}L^3T^{-2}]$$

**Two Crucial Points:**

The force acts along the line joining  $M_1$  and  $M_2$ ; Hence  $\hat{r}$

The force is **ATTRACTIVE**, hence the **MINUS** sign,  $M_1$  and  $M_2$  are being pulled **TOWARD** one another.

As you can see, the equation represents two forces.



**SECOND**

He demonstrated the principle of super position. That is for 3 masses  $M_1$ ,  $M_2$ , and  $M_3$  located as shown.

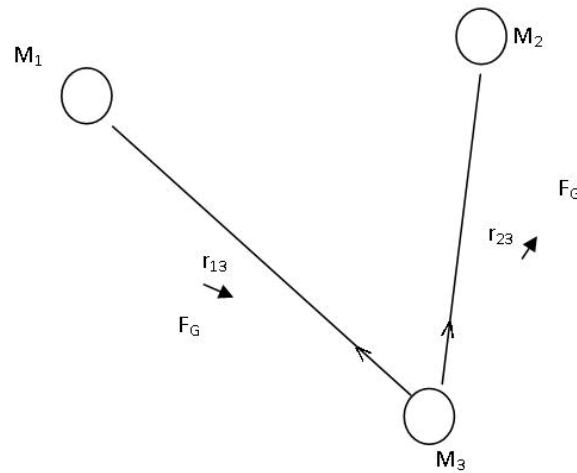

The force on  $M_3$  is

$$\vec{F}_G(3) = \frac{-GM_1M_3}{r_{13}} \hat{r}_{13} - \frac{GM_2M_3}{r_{23}} \hat{r}_{23}$$

$M_3$  is being pulled by both  $M_1$  and  $M_2$ .

**MÄLARDALEN UNIVERSITY SWEDEN**

**WELCOME TO OUR WORLD OF TEACHING!**  
INNOVATION, FLAT HIERARCHIES AND OPEN-MINDED PROFESSORS

**STUDY IN SWEDEN - CLOSE COLLABORATION WITH FUTURE EMPLOYERS**  
MÄLARDALEN UNIVERSITY COLLABORATES WITH MANY EMPLOYERS SUCH AS ABB, VOLVO AND ERICSSON

**TAKE THE RIGHT TRACK**  
GIVE YOUR CAREER A HEADSTART AT MÄLARDALEN UNIVERSITY  
[www.mdh.se](http://www.mdh.se)

**DEBAJYOTI NAG**  
SWEDEN, AND PARTICULARLY MIDH, HAS A VERY IMPRESSIVE REPUTATION IN THE FIELD OF EMBEDDED SYSTEMS RESEARCH, AND THE COURSE DESIGN IS VERY CLOSE TO THE INDUSTRY REQUIREMENTS.  
HE'LL TELL YOU ALL ABOUT IT AND ANSWER YOUR QUESTIONS AT [MDUSTUDENT.COM](http://MDUSTUDENT.COM)



### THIRD

He realized that real objects in nature are essentially made up of continuous distributions of matter so he derived the force between a point object located at  $r$  and a sphere of radius  $R$  located with its center at  $r=0$ .

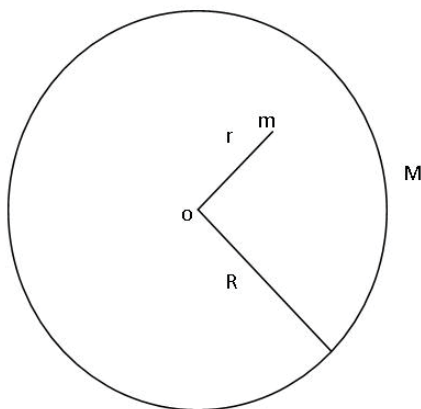

In order to do so he discovered integral calculus and again had to get the result in two steps:

#### Step 1

He calculated the force between a pt. mass  $m$  located at  $r$  and a spherical shell of mass  $M$  and radius  $R$  located with its center at  $r=0$  [Note that for a shell all the mass  $M$  is located at the surface, the space between  $O$  and  $R$  is empty]

I: Amazingly, he found that if  $m$  is located inside the shell, that is  $r < R$  as shown above, the Gravitational force ON IT IS IDENTICALLY EQUAL TO ZERO!

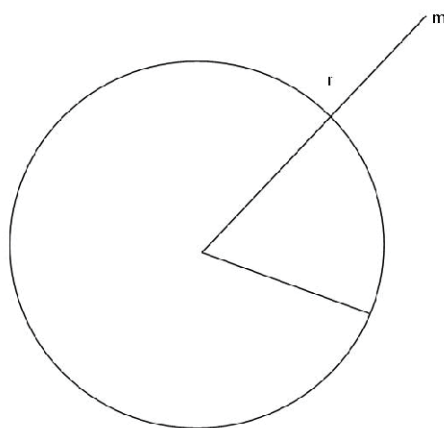

$$\text{If } r < R \quad \underline{F}_G \equiv 0$$

II. He found that if  $m$  is located outside the shell ( $r > R$ ) the force on  $m$  is

$$\vec{F}_G = -\frac{GMm}{r^2} \hat{r}$$

when  $r > R$

In other words, at any point outside, the force on  $m$  is as if the entire mass of the shell was located at its center ( $r=0$ )!

So if we plot the magnitude of  $F_G$  as a function of  $r$  we would get

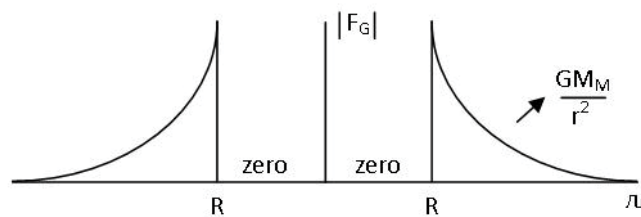

Maximum force on  $m$  is when it is just outside the shell.

**Step 2:**

He used the results of Step 1 to calculate the force between a point mass  $m$  located at  $r$  and a solid sphere of mass  $M$  and radius  $R$  located with its center at  $r=0$ . He assumed that the mass of the sphere was distributed uniformly so that he could define the density.

$$d = \frac{M}{\text{vol. of sphere}} = \frac{M}{\frac{4\pi}{3}R^3}$$

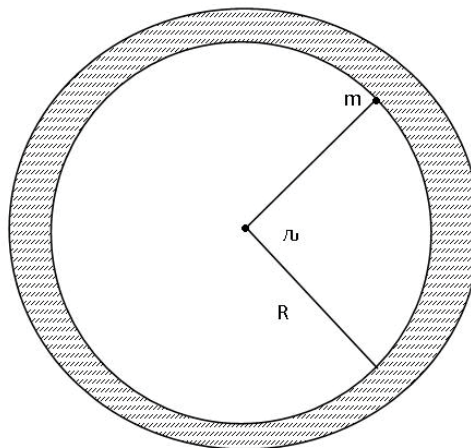

[Density  $ML^{-3}$       $\frac{kg}{m^3}$  scalar]

First, put  $m$  inside the sphere  $r < R$ . One can think of the solid sphere as if it consisted of a large number of concentric shells (an onion comes to mind) and realize that from the point of view of  $m$ , it lies inside all the shells in the shaded area and hence they contribute ZERO to the force on  $m$ .

The force on  $m$  is due to all the shells which are located between  $r=0$  and  $r=r$ . Namely, for  $r < R$

$$\underline{F}_G = \frac{-Gm \times (\text{mass inside } r)}{r^2} \hat{r}$$

$$= \frac{-Gm \times \left(\frac{4\pi}{3} r^3 d\right)}{r^2} \hat{r}$$

$$\underline{F}_G = \frac{-4\pi}{3} GMrd \hat{r}$$

$r < R$

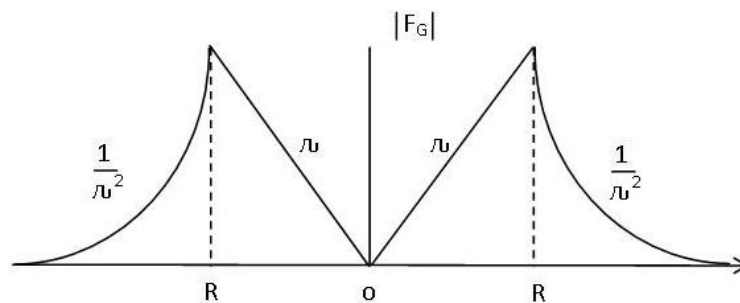

## Develop the tools we need for Life Science Masters Degree in Bioinformatics

Bioinformatics is the exciting field where biology, computer science, and mathematics meet.

We solve problems from biology and medicine using methods and tools from computer science and mathematics.

Read more about this and our other international masters degree programmes at [www.uu.se/master](http://www.uu.se/master)



If  $m$  is located outside ( $r > R$ ) the entire mass  $M$  contributes so that

$$\underline{F}_G = -\frac{GmM}{r^2}\hat{r} \quad r > R$$

Now, the plot of magnitude of  $F_G$  as a function of  $r$  looks like

NOTICE: FORCE IS MAXIMUM when  $m$  is at the surface.

Also if you think of the Earth as a solid sphere your weight reduces as you go in, being zero when you reach the center.

### FINAL STEP

Follows from above discussion. Force between two uniform spheres of masses  $M_1$  and  $M_2$  is given by

$$\underline{F}_G = -\frac{GM_1M_2}{r^2}\hat{r}$$

where  $r$  is measured from center to center.

### APPLICATIONS

I Force on  $m$  near Earth's surface

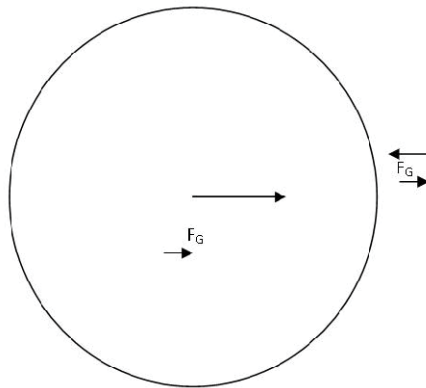

$$R_E \cong 6.4 \times 10^6 \text{ km}$$

$$M_E \cong 6 \times 10^{24} \text{ kg}$$

$$\underline{F}_G = \frac{-Gm \cdot M_E}{R_E^2}\hat{r}$$

$$-9.8mN\hat{r}$$

Similarly, force on Earth due to  $m$  is by Newton's 3<sup>rd</sup> law  $+9.8mN\hat{r}$  acting at Ctr. Of Earth.

II. KEPLER'S LAW  $T_p^2 \propto R_p^3$

Since the planetary orbits are nearly circular, we assume uniform circular motion of a planet of mass  $M_p$  on a circle of radius  $R_p$ . If the angular velocity is  $w_p$  the planet requires a centripetal force

$$\underline{F_C} = -M_p R_p w_p^2 \hat{r}$$

and for the orbit to be stable the sun must provide  $\underline{F_G} = \underline{F_C}$ . That is

$$\begin{aligned} \underline{F_G} &= \frac{-GM_p M_s}{R_p^2} \hat{r} \\ &= \underline{F_C} \end{aligned}$$

where  $M_s$  is the mass of the sun.

$$\frac{-GM_s}{R_p^2} = R_p w_p^2$$

But the period  $T_p = \frac{2\pi}{w_p}$

$$\text{So } \frac{-GM_s}{R_p^2} = R_p \frac{4\pi^2}{T_p^2}$$

$$\text{So } T_p^2 = \frac{4\pi^2}{GM_s} R_p^3$$

We will prove the next Kepler Law after we have discussed Angular Momentum.

III. NOTE THAT FOR SATELLITES\* IN CIRCULAR ORBITS AROUND THE EARTH THE KEPLERIAN LAW BECOMES

$$T_s^2 = \frac{4\pi^2}{GM_E} R_s^3$$

Where  $T_s$  = Period of Satellite

$R_s$  = Radius of Orbit

\*INCLUDE THE MOON

To prove this we note that a satellite of mass  $m_s$  going around the Earth on a circular orbit of radius  $R_s$ , measured from the center of the Earth, requires a centripetal force

$$\underline{F_C} = -m_s R_s w_s^2 \hat{r} \text{ and the Earth provides } \underline{F_G}$$

Equating the two and setting  $T_S = \frac{2\pi}{\omega_S}$

Gives

$$T_S^2 = \frac{4\pi^2}{GM_E} R_S^3$$

Thus, once you pick the period of a Satellite the radius of its orbit is fixed.

### Facts

- Moon, being a Satellite of Earth continuously falling toward the Earth at all times!
- Astronauts in stable orbit become “weightless” ( $N_R \rightarrow 0$ )!



**Nido**

**Luxurious accommodation**

**Central zone 1 & 2 locations**

**Meet hundreds of international students**

**BOOK NOW and get a £100 voucher from voucherexpress**

**Nido Student Living - London**

**Visit [www.NidoStudentLiving.com/Bookboon](http://www.NidoStudentLiving.com/Bookboon) for more info.**

**+44 (0)20 3102 1060**



# 13 Conservation Principles

**CPM:** CONSERVATION OF MASS

IN A CLOSED (NO EXCHANGE OF MATTER WITH SURROUNDINGS) SYSTEM THE TOTAL MASS IS CONSTANT.

**CPE:** CONSERVATION OF ENERGY

IN AN ISOLATED SYSTEM TOTALLY ENERGY IS CONSTANT. IN OUR PRESENT DISCUSSION WE TALK OF MECHANICAL ENERGY.

**CPP:** CONSERVATION OF LINEAR MOMENTUM

IF THERE IS NO EXTERNAL FORCE PRESENT, THE TOTAL (VECTOR) LINEAR MOMENTUM OF A SYSTEM IS CONSTANT.

**CPL:** CONSERVATION OF ANGULAR MOMENTUM

IF THERE IS NO EXTERNAL TORQUE THE TOTAL (VECTOR) ANGULAR MOMENTUM IS CONSTANT.

**CPE**

The ingredients required to state the conservation principle for mechanical energy are:

## Mechanical work

If the point of application of a constant force  $\underline{F}$  is displaced through an amount  $\underline{\Delta S}$  the amount of work done is

$$\begin{aligned}\Delta W &= \underline{F} \bullet \underline{\Delta S} \\ &= F \Delta S \cos(\underline{F}, \underline{\Delta S}) \\ &= F_x \Delta x + F_y \Delta y + F_z \Delta z \\ &[\text{ML}^2 \text{T}^{-2} \text{ JOULE SCALAR}]\end{aligned}$$



so  $\Delta W$  is the “DOT” product of the force vector and the displacement vector. Notice, that we are multiplying the component of  $\underline{F}$  along  $\underline{\Delta S}$  by  $\Delta S$  to get the work done. No work is DONE if  $\underline{F} \perp \underline{\Delta S}$ . Also, note that  $\underline{\Delta S}$  measures the total displacement of  $\underline{F}$ . For example, AB is half a circle of radius  $R$ . If you apply a force  $\underline{F}$  which is tangent to circle at every point, total work done is

$$\Delta W = F\pi R$$

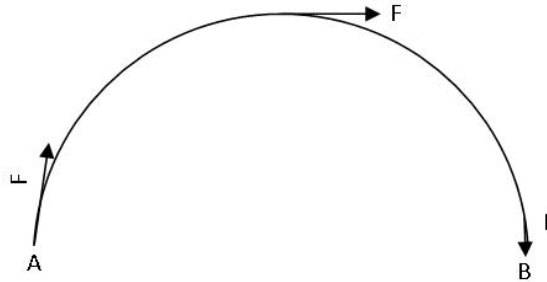

If  $F_x$  varies with  $x$ , work done is area under  $F_x$  vs.  $x$  curve.

Ex: Spring Force  $\underline{F} = -kx\hat{x}$   
Work done by spring in going from  $x$  to zero is

$$\Delta W = \frac{1}{2}kx^2$$

# Brain power



By 2020, wind could provide one-tenth of our planet's electricity needs. Already today, SKF's innovative know-how is crucial to running a large proportion of the world's wind turbines.

Up to 25 % of the generating costs relate to maintenance. These can be reduced dramatically thanks to our systems for on-line condition monitoring and automatic lubrication. We help make it more economical to create cleaner, cheaper energy out of thin air.

By sharing our experience, expertise, and creativity, industries can boost performance beyond expectations. Therefore we need the best employees who can meet this challenge!

The Power of Knowledge Engineering

Plug into The Power of Knowledge Engineering.  
Visit us at [www.skf.com/knowledge](http://www.skf.com/knowledge)





Click on the ad to read more

## KINETIC ENERGY

MECHANICAL WORK STORED IN GIVING A FINITE SPEED TO A MASS-WORK STORED IN MOTION

Object at rest at  $x_0$ . Apply force  $\underline{F} = F\hat{x}$ , keep force on until object reaches  $x$ .

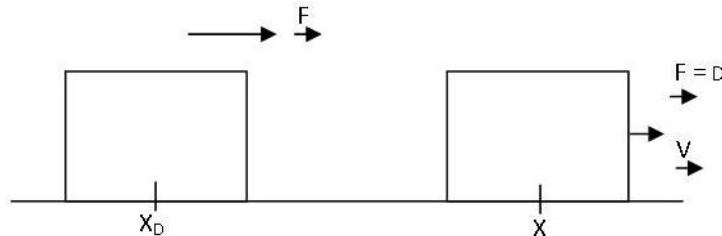

$$\begin{aligned}\Delta W &= F(x - x_0) \\ &= Ma(x - x_0)\end{aligned}$$

But we know that  $v^2 = v_0^2 + 2a(x - x_0)$

$$v_0 = 0, \quad v = 2a(x - x_0)$$

So  $\Delta W = \frac{1}{2}Mv^2$

After  $\underline{F}$  turned off,  $M$  moved on with speed  $v$ . We have stored kinetic energy

$$K = \frac{1}{2}Mv^2$$

in its motion.

## POTENTIAL ENERGY

MECHANICAL WORK STORED IN A SYSTEM WHEN IT IS ASSEMBLED IN THE PRESENCE OF A PREVAILING CONSERVATIVE FORCE  $\underline{F}$ .

Potential Energy (P) presents a greater conceptual challenge.

P is the mechanical work stored in a system when it is prepared (or put together) in the presence of a prevailing conservative force.

Suppose we have a region of space in which there is a prevailing force (weight near Earth's surface comes to mind). That is, at every point in this region an object will experience a force. Let the object be at point B [First, notice that you can't let the object go as  $\underline{F}$  will immediately cause  $\underline{a}$  and object will move].

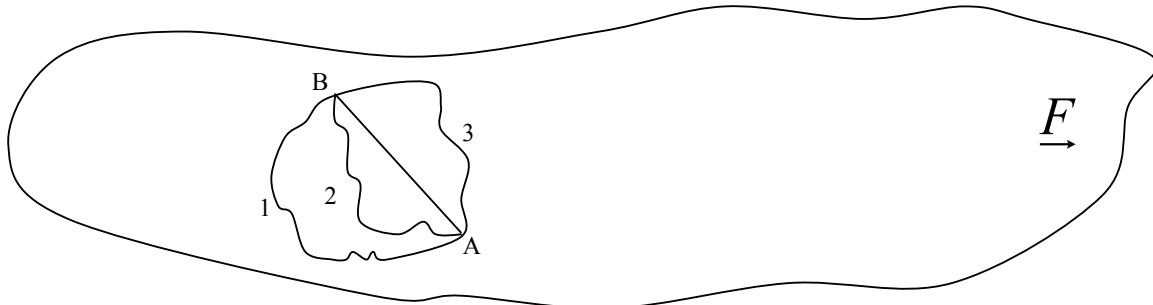

To define P at B we have to calculate how much work was needed to put the object at B in the presence of  $\underline{F}$ . Let us pick some point A, where we can claim that P is known, and calculate the work needed to go from A to B. As soon as we try to do that we realize that the only way we can get a meaningful answer is if the work required to go from A to B is independent of the path taken. So our prevailing force has to be special. Such a force is called a CONSERVATIVE FORCE – WORK DONE DEPENDS ONLY ON END-POINTS AND NOT ON THE PATH TAKEN.

If that is true we have a unique answer

$$\Delta w_1 = \Delta w_2 = \Delta w_3 = \Delta w_{AB}$$

and we can use this fact to calculate the change in P in going from A to B

$$\Delta P_{AB} = -\underline{F} \bullet \underline{\Delta S}_{AB}$$

NOTE THE – SIGN: It comes about because as stated above we cannot let the object go. In fact, the displacement from A to B must be carried out in such a way that the object cannot change its speed (if any). That is, we need to apply a force  $-\underline{F}$  to balance the ambient  $\underline{F}$  at every point. The net force will become close to zero at all points.  $\Delta P_{AB}$  is work done by  $-\underline{F}$ .

So when  $\underline{F}$  is conservative  $\Delta P_{AB}$  is unique. In the final step we can choose A such that  $P_A = 0$ . Then  $P_B = -\underline{F} \bullet \underline{\Delta S}_{AB}$ .

Change in potential energy

$$\Delta P = -\underline{F} \bullet \underline{\Delta S}$$

(NEVER FORGET THE “MINUS” SIGN! WHY?)

We have two conservative forces available

1.  $\underline{W}_g = -Mg\hat{y}$ , so taking  $P_g = 0$  at Earth's surface we write

$$P_g(y) = Mgy$$

as the potential energy of the Mass-Earth system.

2.  $\underline{F}_{sp} = -kx\hat{x}$  so

$$P_{sp}(x) = \frac{1}{2}kx^2$$

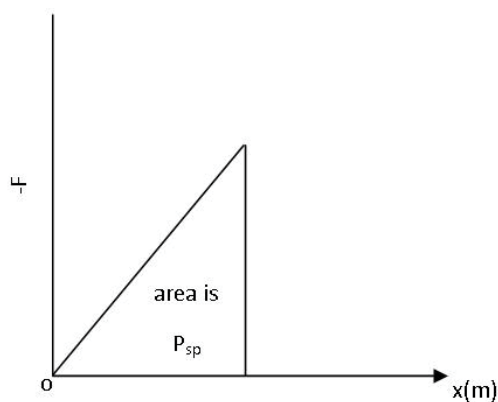

Now we have all three  $W$ ,  $K$ , and  $P$  we can write **CPE**.

#### ISOLATED SYSTEM

$$K_f + P_f = K_i + P_i$$

$i$  = initial state

$f$  = final state

#### EXTERNAL WORK INCLUDED

$$K_f + P_f = K_i + P_i + W_{NCF}$$

$NCF$  refers to Non-Conservative force. (friction, force applied by your hand etc.)

**Note:** if  $NCF$  is  $f_k$ ,  $W_{NCF}$  IS MOSTLY NEGATIVE!!!

# 14 Potential Energy – Gravitational Force

We can define a potential energy for the Gravitation force. We begin by proving that

$$\underline{F}_G = \frac{-GM_1M_2}{r^2} \hat{r}$$

is a conservative force. That is work done is independent of the path. The crucial point here is that  $\underline{F}_G$  is directed along the **line joining**  $M_1$  and  $M_2$ . We will use this to prove that  $\underline{F}_G$  is conservative. Let us fix  $M_1$  at  $r = 0$  and move  $M_2$ .

## Path 1

We take  $M_2$  from A ( $R_A$ ) **along** the radius to point B ( $R_B$ ),  $\underline{F}_G$  is parallel to path we can calculate  $\Delta W_{AB}$

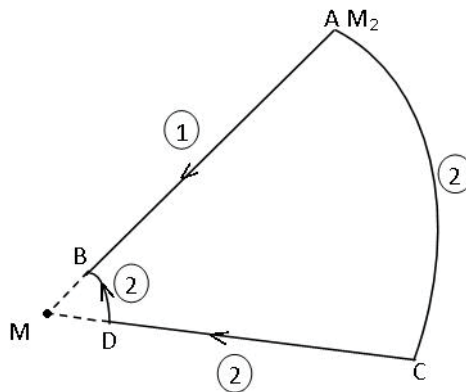

## Path 2

Start at A and go along the circumference from A to C. Now  $\underline{F}_G \perp$  path so no work done. Now go along Radius CD = AB.  $\underline{F}_G$  is same, displacement is same so  $\Delta W_{CD} = \Delta W_{AB}$

Now go along circumference DB. Again

$$\Delta W_{DB} = 0 \quad [\underline{F}_G \perp \text{Displacement}]$$

So

$$\Delta W_{AB} = \Delta W_{ABCD}$$

WORK DONE IS INDEED INDEPENDENT OF PATH!

### APPLICATIONS

**Case I** Potential Energy of  $M_1, M_2$  system (two point masses)

Place  $M_2$  at  $r = 0$

$$\text{Force on } M_2 \text{ is } \underline{F}_G = \frac{-GM_1M_2}{r^2} \hat{r}$$

Change of Potential Energy  $\Delta P = -\Sigma \underline{F}_G \bullet \underline{\Delta r}$

To calculate  $P$  when  $M_2$  is at  $r$  we must calculate work needed to put  $M_2$  at  $r$  starting from some point where  $P$  is zero. Since  $\underline{F}_G \rightarrow 0$  as  $r \rightarrow \infty$  we choose  $P$  to equal zero when  $M_2$  is very far away and calculate work done to bring  $M_2$  to  $r$ . We will get

$$P_G(M_1, M_2) = \frac{-GM_1M_2}{r}$$

$P_G$  is negative everywhere as shown in plot.

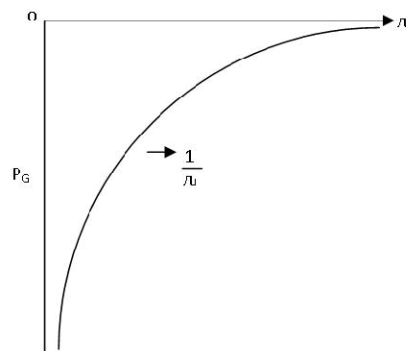

**Case II** Mass shell centered at  $r = 0$ , and point mass  $m$  at  $r$ .

$$\text{Now } \underline{F}_G = \frac{-GMm}{r^2} \quad r > R$$

$$\underline{F}_G = 0 \quad r < R$$

We get

$$P_G = -\frac{GMm}{r} \quad r > R$$

$$P_G = -\frac{GMm}{R} \quad r < R$$

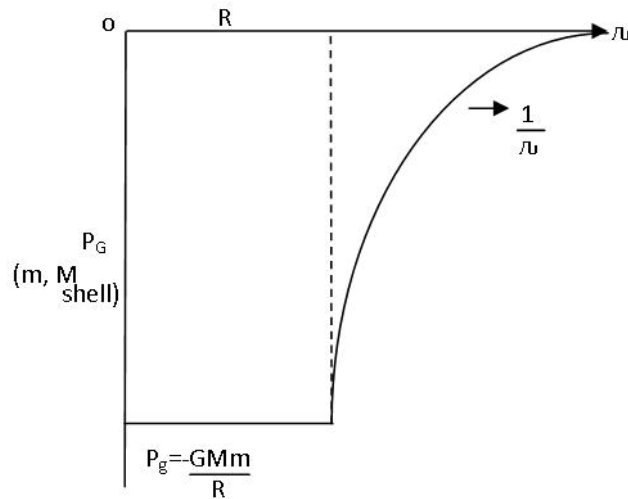

**Case III** Solid uniform sphere centered at  $r = 0$  and  $m$  at  $r$

$$\text{Now } \underline{F_G} = -\frac{GMm}{r^2} \quad r > R$$

$$\underline{F_G} = -\frac{4\pi}{3} Gdmr \quad r < R$$

# GET A MASTER'S DEGREE IN UMEÅ!

- modern campus • world class research • 32 000 students
- top class teachers • ranked nr 1 in Sweden by international students

**Master's programmes:**

- Architecture
- Industrial Design
- Science
- Engineering

Download  
brochure  
here!



UMEÅ UNIVERSITY

FACULTY OF SCIENCE & TECHNOLOGY



We get

$$r > R \quad P_G = -\frac{GMm}{r}$$

$$r = R \quad P_G = -\frac{GMm}{R}$$

$$r < R \quad P_G = -\frac{GMm}{R} - \frac{GMm}{2R} \left(1 - \frac{r^2}{R^2}\right)$$

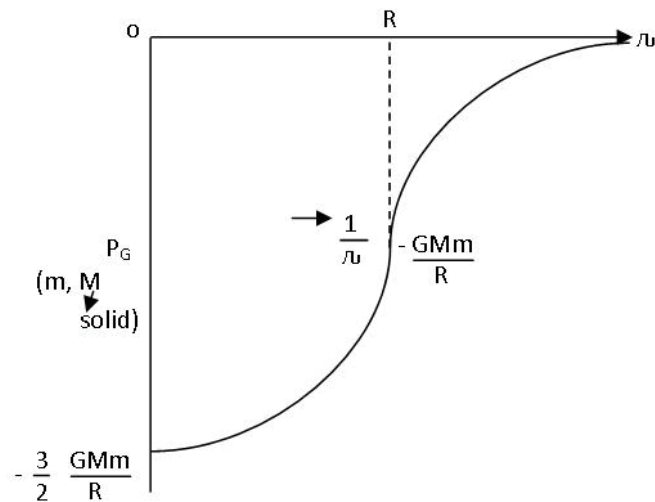

**Case IV** Special case  $m$  just outside Earth at height  $h$ . Then  $r = R_E + h$ ,  $h < R_E$

Potential Energy of Earth – Mass System

$$P_G(h) = -\frac{GM_E m}{R_E + h} = -\frac{GM_E m}{R_E \left(1 + \frac{h}{R_E}\right)} = -\frac{GM_E m}{R_E} \left(1 + \frac{h}{R_E}\right)^{-1}$$

Since  $\frac{h}{R_E} < 1$        $\left(1 + \frac{h}{R_E}\right)^{-1} = 1 - \frac{h}{R_E}$

$$P_G(h) = -\frac{GM_E m}{R_E} \left(1 - \frac{h}{R_E}\right) = -\frac{GM_E m}{R_E} + \frac{GM_E m}{R_E^2} h$$

$$P_G(h) = -\frac{GM_E m}{R_E} + mgh$$

Recall that we previously wrote  $mgh$  for the Earth Mass system. Note that in fact our potential energy is very large and **NEGATIVE**. That ensures that we stay close to the Earth.



# 15 Conservation of Linear Momentum

An object of mass  $M$  travelling at a velocity  $\underline{v}$  is said to have a linear momentum given by the equation

$$\underline{p} = M \underline{v} \quad (1)$$

[Lin Mom<sup>m</sup>                                       $MLT^{-1}$                                        $kg - m / sec$                                       VECTOR]

The immediate consequences of defining  $\underline{p}$  are that Newton's Laws should be read as:

**First law:** Objects do not change their linear momentum spontaneously

**Second Law:** If the linear momentum  $\underline{p}$  varies with time there must be a net force present at that point at the time. That is

$$\frac{\underline{p}_f - \underline{p}_i}{t_f - t_i} \approx \langle \Sigma \underline{F}_i \rangle \quad (\text{Average}) \quad (2)$$

$$\lim_{\Delta t \rightarrow 0} \frac{\Delta \underline{p}}{\Delta t} = \Sigma \underline{F}_i \quad (\text{Instantaneous}) \quad (3)$$

**Scholarships**

**Open your mind to new opportunities**

With 31,000 students, Linnaeus University is one of the larger universities in Sweden. We are a modern university, known for our strong international profile. Every year more than 1,600 international students from all over the world choose to enjoy the friendly atmosphere and active student life at Linnaeus University. Welcome to join us!

**Linnaeus University**  
Sweden

**Ln.u.se**

**Bachelor programmes in**  
*Business & Economics | Computer Science/IT | Design | Mathematics*

**Master programmes in**  
*Business & Economics | Behavioural Sciences | Computer Science/IT | Cultural Studies & Social Sciences | Design | Mathematics | Natural Sciences | Technology & Engineering*

**Summer Academy courses**



Also, the Kinetic Energy should be written

$$K = \frac{1}{2} Mv^2 = \frac{p^2}{2M} \quad (4)$$

Note: if two objects have the same momentum (magnitude) the smaller M has a larger K!

One can turn Eqn. (2) around to define a vector quantity called impulse,  $\underline{J}$ , which is the change in momentum caused by the application of a large force over a short time interval

If  $\underline{F}$  is constant

$$\underline{J} = \underline{p}_f - \underline{p}_i = \underline{F}\Delta t \quad (5)$$

If  $\underline{F}$  varies with time then to calculate  $\underline{J}$  you draw  $F$  as a function of time and calculate the area under the  $F$  vs.  $t$  graph to determine  $\underline{J}$ .

So much for single particles. To formulate the principle of conservation of momentum ( $\underline{P}$ ) we need to consider a system consisting of many (at the very least two) objects and they **cannot** be point particles because point particles will not “collide” and we need the objects to collide. So now our system, is a “box” containing many objects of masses  $M_1, M_2, \dots$  with velocities  $\underline{v}_1, \underline{v}_2, \dots$  and we can write

$$\underline{p}_i = M_i \underline{v}_i$$

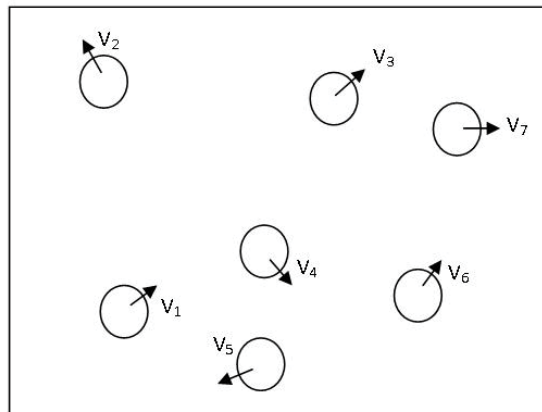

clearly, the system will have a total mass

$$M = \Sigma M_i$$

and a total momentum

$$P = \Sigma M_i \underline{v}_i$$

Now suppose two of the masses collide as shown.

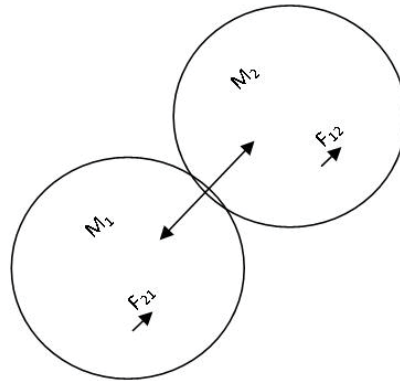

At the instant of collision, Newton's 3<sup>rd</sup> Law tells us that the force  $\underline{F}_{21}$  on  $M_1$  due to  $M_2$  must be equal and opposite to the force  $\underline{F}_{12}$  on  $M_2$  due to  $M_1$  that is

$$\underline{F}_{12} + \underline{F}_{21} = 0 \longrightarrow \text{CRUCIAL POINT}$$

If the collision lasts for  $\Delta t$  seconds, the impulse on  $M_1$  is

$$\underline{J}_1 = \underline{F}_2 \Delta t$$

while

$$\underline{J}_2 = \underline{F}_1 \Delta t$$

and therefore

$$\underline{J}_1 + \underline{J}_2 = 0$$

But  $\underline{J}_1 =$  change in momentum of  $M_1$

$\underline{J}_2 =$  change in momentum of  $M_2$

So this equation tells us that whatever vector momentum  $M_1$  gains (loses) must be lost (gained) by  $M_2$ . So no matter how many collisions occur, if there is no external force the internal forces always come in action-reaction pairs and therefore the total vector momentum  $\underline{p}$  of the system cannot change.

PRINCIPLE OF CONSERVATION OF LINEAR MOMENTUM SAYS: If  $\underline{F}_{ext} = 0$ , total vector momentum of a system is constant:

$$\text{If } \underline{F}_{ext} = 0, \Sigma \underline{p}_i = \text{Constant} \quad (6)$$

In considering the motion of the entire system a useful concept is that of the Center of Mass. Let our masses  $M_i$  be located at  $(x_i, y_i)$  in the xy-plane, the coordinates of the center of mass are

$$x_{CM} = \frac{\Sigma M_i x_i}{\Sigma M_i}, \quad y_{CM} = \frac{\Sigma M_i y_i}{\Sigma M_i}$$

[Near Earth  $x_{CM} = x_{CG}, y_{CM} = y_{CG}$ ]

If the masses are moving, the displacements will be

$$\underline{\Delta x}_i \text{ and } \underline{\Delta y}_i$$

$$M \underline{\Delta x}_{CM} = \Sigma M_i \frac{\Delta x_i}{\Delta t}$$

$$M \underline{\Delta y}_{CM} = \Sigma M_i \frac{\Delta y_i}{\Delta t}$$

Indeed  $M \underline{v}_{CM} = \Sigma M_i \underline{v}_i = \underline{p}$

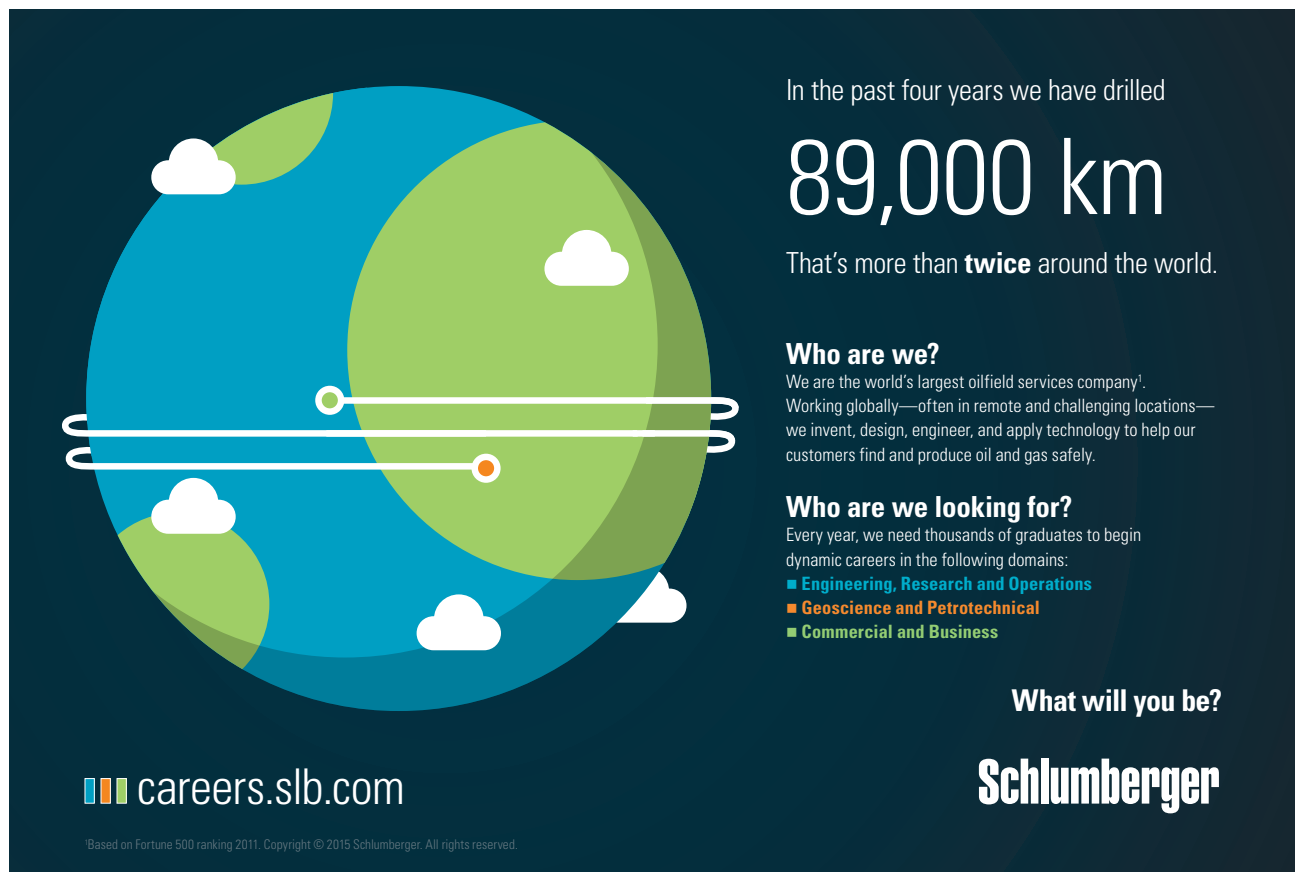

In the past four years we have drilled

# 89,000 km

That's more than **twice** around the world.

**Who are we?**  
We are the world's largest oilfield services company<sup>1</sup>. Working globally—often in remote and challenging locations—we invent, design, engineer, and apply technology to help our customers find and produce oil and gas safely.

**Who are we looking for?**  
Every year, we need thousands of graduates to begin dynamic careers in the following domains:

- Engineering, Research and Operations
- Geoscience and Petrotechnical
- Commercial and Business

**What will you be?**

[careers.slb.com](http://careers.slb.com)

**Schlumberger**

<sup>1</sup>Based on Fortune 500 ranking 2011. Copyright © 2015 Schlumberger. All rights reserved.



So conservation law says if  $\underline{F}_{ext} = 0$ , velocity of center of mass is CONSTANT.

If  $\underline{F}_{ext} \neq 0$

$$\left. \begin{aligned} M \underline{a}_{CM} &= \Sigma \underline{F}_{ext} \\ \text{Or} \\ \frac{\Delta p}{\Delta t} &= \Sigma \underline{F}_{ext} \end{aligned} \right\} \text{Newton's Law}$$

That is, one can pretend that the total mass M is located at the Center of Mass and treat it as a “translation” of the “box” as a whole.

**TWO-BODY COLLISIONS**

Let us take two pucks and put them on a horizontal frictionless surface thereby making  $\underline{F}_{ext} = 0$  because firstly  $(n - Mg) = 0$  and

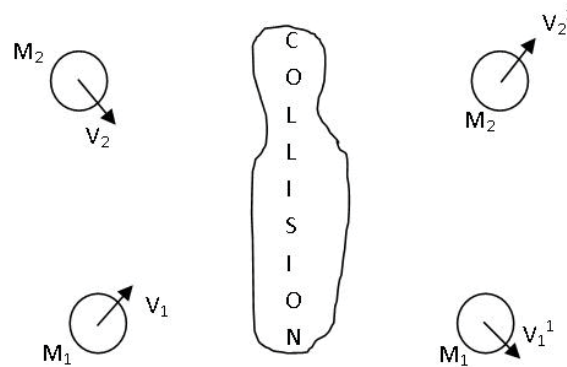

also  $f_k = 0$ . The pucks are given velocities  $\underline{v}_1$  and  $\underline{v}_2$ , allowed to collide and emerge with velocities  $\underline{v}_1'$  and  $\underline{v}_2'$

The corresponding momenta are

Before		After
$\underline{p}_1 = M_1 v_1$		$\underline{p}_1' = M_1 v_1'$
$\underline{p}_2 = M_2 v_2$		$\underline{p}_2' = M_2 v_2'$

and the conservation law requires

$$\underline{p}_1' + \underline{p}_2' = \underline{p}_1 + \underline{p}_2 \tag{7}$$

(Total Vector Momentum After) = (Total Vector Momentum Before)

The question we need to answer is: Given  $M_1, M_2$  and  $\underline{v}_1, \underline{v}_2$  do we have enough information to figure out  $\underline{v}_1'$  and  $\underline{v}_2'$ ? The answer is **No**. Why?

Let us put the objects in the xy-plane.

Eqn. (7) yields

$$M_1 v_{1x}' + M_2 v_{2x}' = M_1 v_{1x} + M_2 v_{2x} \quad (8)$$

$$M_1 v_{1y}' + M_2 v_{2y}' = M_1 v_{1y} + M_2 v_{2y} \quad (9)$$

The problem is that we have only two equations but there are 4 unknowns [ $v_{1x}', v_{2x}', v_{1y}', v_{2y}'$ ] and therefore no unique solution is possible. We need to add further specification to the type of collision in order to get a solution.

We consider two special cases:

### Type I Totally Inelastic Collision

The two objects stick together after the collision

$$\underline{v}_1' = \underline{v}_2' \quad [\text{Totally Inelastic Collision}]$$

And now we can use Eqn. (8) and Eqn. (9) to get precise answers.

### Type II Totally Elastic Collision

Kinetic Energy is also conserved:

$$(\text{Total Kinetic Energy After}) = (\text{Total Kinetic Energy Before})$$

This gives us another equation

$$\frac{1}{2} M v_1'^2 + \frac{1}{2} M v_2'^2 = \frac{1}{2} M v_1^2 + \frac{1}{2} M v_2^2 \quad (10)$$

Now we have 3 equations (8), (9), (10) and we still have a problem because we have four unknowns.

We simplify further by specifying that the collision is “head-on”

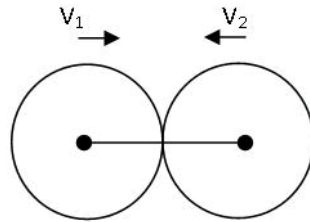

Now the forces  $\underline{F}_{12}$  and  $\underline{F}_{21}$  are parallel to the relative velocity  $(\underline{v}_1 - \underline{v}_2)$  so it becomes essentially a one-dimensional problem.

We can take all the vectors to be along the x-axis,  $\underline{v}_1 = v_1 \hat{x}$ ,  $\underline{v}_2 = v_2 \hat{x}$ ,  $\underline{v}_1' = v_1' \hat{x}$ ,  $\underline{v}_2' = v_2' \hat{x}$  and the conservation equations become

$$\text{Lin. Mom}^m \quad M_1 v_1' + M_2 v_2' = M_1 v_1 + M_2 v_2 \quad (11)$$

$$\text{Kin. En.} \quad M_1 \frac{v_1'^2}{2} + M_2 \frac{v_2'^2}{2} = M_1 \frac{v_1^2}{2} + M_2 \frac{v_2^2}{2} \quad (12)$$

## Trust and responsibility

NNE and Pharmaplan have joined forces to create NNE Pharmaplan, the world’s leading engineering and consultancy company focused entirely on the pharma and biotech industries.

Inés Aréizaga Esteva (Spain), 25 years old  
Education: Chemical Engineer

– You have to be proactive and open-minded as a newcomer and make it clear to your colleagues what you are able to cope. The pharmaceutical field is new to me. But busy as they are, most of my colleagues find the time to teach me, and they also trust me. Even though it was a bit hard at first, I can feel over time that I am beginning to be taken seriously and that my contribution is appreciated.



NNE Pharmaplan is the world’s leading engineering and consultancy company focused entirely on the pharma and biotech industries. We employ more than 1500 people worldwide and offer global reach and local knowledge along with our all-encompassing list of services.  
[nnepharmaplan.com](http://nnepharmaplan.com)

nne pharmaplan®



Now we can use algebra to solve for  $v_1'$  and  $v_2'$

Rewrite Eqns. (11) and (12) as

$$(v_1' - v_1) = \frac{M_2}{M_1}(v_2 - v_2') \quad (11')$$

$$(v_1'^2 - v_1^2) = \frac{M_2}{M_1}(v_2^2 - v_2'^2) \quad (12')$$

Divide Eqn. (12') by Eqn. (11')

$$(v_1 + v_1') = (v_2 + v_2') \quad (13)$$

or

$$\longrightarrow (v_1' - v_2') = (v_2 - v_1) = -(v_1 - v_2) \quad (A)$$

IN TOTALLY ELASTIC HEAD ON COLLISION THE RELATIVE VELOCITY REVERSES DIRECTION AS A RESULT OF THE COLLISION.

Next take Eqn. (11) write  $M_1v_1' = M_1v_1 + M_2v_2 - M_2v_2'$

Next take Eqn. (13)  $= M_1v_1 + M_2v_2 - M_2(v_1 + v_1' - v_2)$

Rearrange  $(M_1 + M_2)v_1' = (M_1 - M_2)v_1 + 2M_2v_2$

Yielding  $v_1' = \frac{M_1 - M_2}{M_1 + M_2}v_1 + \frac{2M_2v_2}{M_1 + M_2} \quad (B)$

Similarly  $v_2' = \frac{M_2 - M_1}{M_1 + M_2}v_2 + \frac{2M_1v_1}{M_1 + M_2} \quad (C)$

Or respecting the vector nature of the velocities ( $\pm \hat{x}$ ) we write

$$\begin{aligned} \vec{v}_1' &= \frac{M_1 - M_2}{M_1 + M_2} \vec{v}_1 + \frac{2M_2}{M_1 + M_2} \vec{v}_2 \\ \vec{v}_2' &= \frac{M_2 - M_1}{M_1 + M_2} \vec{v}_2 + \frac{2M_1}{M_1 + M_2} \vec{v}_1 \end{aligned}$$

It is interesting to discuss one case because it led to the development of the concept of linear momentum.



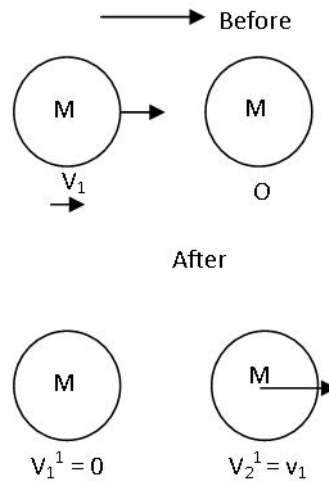

Head on collision:  $M_1 = M_2$

Before velocities are  $\underline{v_1} = v_1 \hat{x}$

$$\underline{v_2} = 0$$

Then from Eqs. (B) and (C) we

Get  $\underline{v_1^1} = 0$

$$\underline{v_2^1} = v_1 \hat{x}$$

Before:  $M_1$  is moving,  $M_2$  at rest

After:  $M_1$  is at rest,  $M_2$  has the velocity

Which  $M_1$  had before the collision

# 16 Circular Motion When Speed is NOT Constant

Up to now we have been considering circular motion where the speed was constant so we could define period  $T$ , and write  $S = \frac{2\pi R}{T}$

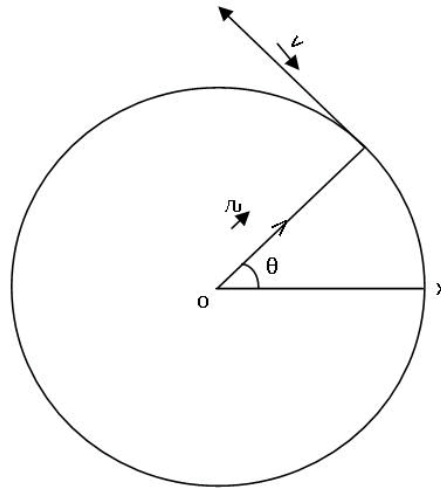

This e-book  
*is made with*  
**SetaPDF**

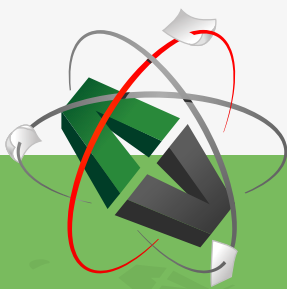

PDF components for PHP developers

[www.setasign.com](http://www.setasign.com)



$$\underline{r} = R\hat{r} \quad \text{rotating by } \omega \text{ radians per second}$$

$$\underline{v} = R\omega\hat{t} \quad \text{rotating by } \omega \text{ radians per second}$$

$$\underline{a}_c = -R\omega^2\hat{r} \quad \text{rotating by } \omega \text{ radians per second}$$

$$\underline{\omega} = \pm \frac{\Delta\Theta}{\Delta t} \hat{n} \quad \longrightarrow \text{ constant}$$

If we want to think of how the angle  $\Theta$  changes with time we can construct a table let  $\omega = 0.1 \text{ rad/s}$  and write  $\underline{\Theta} = (\Theta_i + \omega t)\hat{n}$  where  $\Theta_i$  is angle at  $t = 0$  exactly as we wrote  $\underline{x} = (x_i + vt)\hat{x}$  sometime ago.

time (sec)	$\Delta\Theta$ (rad)
1	0
2	0.1
3	0.2
$t$	$0.1t$

Next, we want to consider a situation where speed is not constant. This means that the angular speed is also not constant. We will not change the direction of  $\underline{\omega}$ , only its magnitude and define  $\alpha$  angular acceleration vector

$$\underline{\alpha} = \frac{\Delta\underline{\omega}}{\Delta t} \quad \left[ L^2 T^{-2} \text{ rad} / s^2 \text{ vector} \right]$$

and  $\alpha$  measures the change in  $\omega$  per second so now

$$\underline{\omega} = \pm(\omega_i + \alpha t)\hat{n} \quad \left[ \text{Compare } \underline{v} = (v_i + at)\hat{x} \right]$$

where  $\omega_i$  is angular velocity at  $t = 0$ . And following the same steps as before

$$\underline{\Theta} = \pm \left( \Theta_i + \omega_i t + \frac{1}{2} \alpha t^2 \right) \hat{n} \quad \left[ \text{Compare } \underline{x} = \pm \left( x_i + v_i t + \frac{1}{2} at^2 \right) \hat{x} \right]$$

So kinematic equations are

Linear Motion (one dimension)	Angular Motion (rotations about $\hat{n}$ )
$x$	$\Theta$
$\underline{a} = a\hat{x}$	$\underline{\alpha} = \alpha\hat{n}$
$\underline{v} = (v_i + at)\hat{x}$	$\underline{\omega} = \pm(\omega_i + \alpha t)\hat{n}$
$\underline{x} = \pm\left(x_i + v_i t + \frac{1}{2}\alpha t^2\right)\hat{x}$	$\underline{\Theta} = \pm\left(\Theta_i + \omega_i t + \frac{1}{2}\alpha t^2\right)\hat{n}$
$v^2 = v_i^2 = 2a(x - x_i)$	$\omega^2 = \omega_i^2 = 2\alpha(\Theta - \Theta_i)$

To cause an acceleration  $\underline{a}$ , Newton taught us that we must provide a force at that point at that time

$$M\underline{a} = \Sigma\underline{F}_i \quad (\text{at that point at that time})$$

What do we need to cause angular acceleration  $\underline{\alpha}$ ? A new physical agency which we will develop next.

Before we go there let us note that we still have

$$\begin{aligned} \underline{r} &= R\hat{r} \\ \underline{v} &= R\omega\hat{\tau} \\ \underline{a}_c &= -R\omega^2\hat{r} \end{aligned}$$

but they no longer rotate at constant rates and the magnitudes of  $v$  and  $\underline{a}_c$  are now varying with time. Indeed now in addition to centripetal acceleration we have TANGENTIAL ACCELERATION

$$\underline{a}_t = R \frac{\Delta\omega}{\Delta t} \hat{\tau} = R \alpha \hat{\tau}$$

and in accord with Newton's Law we not only need a centripetal force

$$\underline{F}_C = -MR\omega^2\hat{r}$$

but also a tangential force

$$\underline{F}_t = +Ma_t\hat{\tau}$$

which leads to a new physical agency.

# 17 Torque

**TORQUE:** IS THE PHYSICAL AGENCY WHICH IS NECESSARY TO CAUSE ANGULAR ACCELERATION AND HENCE ROTATION ABOUT AN AXIS. WE WILL CONSIDER THE CASE OF ROTATION ABOUT A FIXED AXIS. TO HAVE A TORQUE ONE MUST **APPLY A FORCE AT SOME DISTANCE FROM THE AXIS ABOUT WHICH ROTATION IS DESIRED.**

Consider the following:

You want to open a door which is hinged along the y-axis.

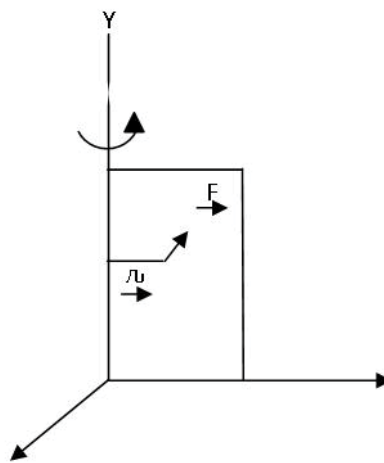

You pick a point which is some distance  $r$  from the hinge. Indeed the larger the  $r$  the less push (force) you will need to cause the door to swing. Next, you need to apply a force **perpendicular** to  $r$ . If  $\underline{F}$  is parallel to  $r$  the door will never open. Notice that  $r \parallel \hat{x}$ ,  $\underline{F} \parallel -\hat{z}$  but door rotates about  $\hat{y}$ . Indeed the physical agency that causes the swing is the Torque Vector,  $\underline{\tau}$  which is parallel to  $\hat{y}$ . Amazing,  $r$  is horizontal,  $\underline{F}$  is horizontal but  $\underline{\tau}$  is vertical.

We need a new concept in vector algebra such that multiplying two vectors produces a third vector which is perpendicular to both of them. Such a product is called a vector product or cross product. Given two vectors  $\underline{A}$  and  $\underline{B}$  with an angle

$$\Theta = (\underline{A}, \underline{B})$$

Between them, the vector product is written as

$$\underline{C} = (\underline{A} \times \underline{B})$$

The magnitude of  $C$  is

$$C = AB \sin(\underline{A}, \underline{B})$$

$\underline{C}$  is perpendicular to the  $AB$  plane. Which perpendicular?

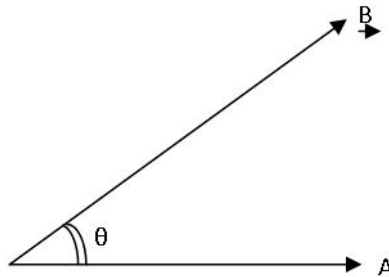

Right Hand Rule: Stretch right hand

First Vector	$\underline{A}$    Thumb
Second Vector	$\underline{B}$    Fingers
Third Vector	$\underline{C}$ $\perp$ Palm

“I studied English for 16 years but...  
...I finally learned to speak it in just six lessons”  
Jane, Chinese architect

ENGLISH OUT THERE

Click to hear me talking before and after my unique course download



The Torque Vector can now be defined formally. A bar of length  $r$  can pivot (rotate) about an axis perpendicular to point I. We apply force  $\underline{F}$  as shown

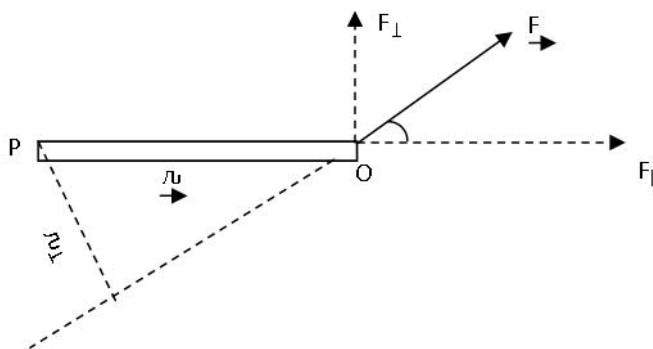

Torque

$$\underline{\tau} = \underline{r} \times \underline{F}$$

Direction of  $\underline{r}$  is always from pivot point  $P$  to point of application ( $O$ ) of force  $\underline{F}$ .

Direction of  $\underline{\tau}$  along  $+\hat{z}$

Magnitude of

$$F_{\perp} = \text{Component of } \underline{F} \perp \text{ Bar}$$

$$r_{\perp} = \text{Perpendicular distance between } \underline{F} \text{ (extended) and } P \text{ [sometimes called moment arm].}$$

Immediately one notices

$$\underline{\tau} \text{ is zero if } \underline{F} \parallel \underline{r}$$

$$\underline{\tau} \text{ is maximum when } \underline{F} \perp \underline{r}$$

# 18 Types of Motion of Rigid Body

**Translation:** All the masses have the same linear velocity and the same linear acceleration

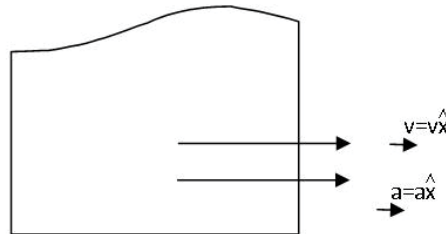

$$\sum \underline{F}_i \neq 0$$

$$\sum \underline{\tau}_i = 0$$

[Indeed  $\underline{v} = \underline{v}_{C \cdot G}$ ]

**Rotation** about a fixed axis: Now the angular velocity and the angular acceleration are the same for all  $m_i$

Now 
$$\sum \underline{F}_i = 0$$

$$\sum \underline{\tau}_i \neq 0$$

Torque on  $m_i$  
$$\underline{\tau}_i = r_i F_i \hat{z}$$

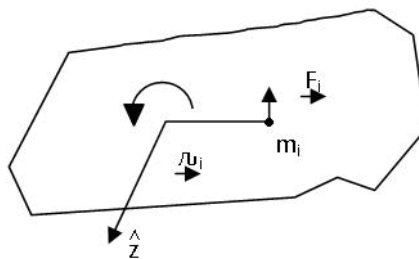

All torques  $\parallel \hat{z}$ . Total Torque

$$\underline{\tau} = \sum r_i F_i \hat{z} = \sum r_i m_i a_i \hat{z}$$

$$= \sum m_i r_i^2 \alpha \hat{z} = I \alpha$$

Defines moment of Inertia  $I = \sum m_i r_i^2$



**For equilibrium** we need two conditions

$$\underline{a} = 0 \text{ and } \underline{\alpha} = 0 \text{ so } \Sigma \underline{F}_i \equiv 0$$

$$\Sigma \underline{\tau}_i \equiv 0$$

All torques taken about a single axis.

The table below summarizes the equations when  $\underline{a} \neq 0$  and  $\underline{\alpha} \neq 0$ . (Dynamics)

Translation (one dimension, x)	Rotation (Fixed axis, Z)
$\underline{x}$	$\underline{\Theta}$
$\underline{v}$	$\underline{\omega}$
$\underline{a} = a\hat{x}$	$\underline{\alpha} = \alpha\hat{z}, \underline{a}_i = \alpha r_i \hat{t}_*$
$\underline{v} = (v_i + \underline{a} t)\hat{x}$	$\underline{\omega} = (\omega_i + \alpha t)\hat{z}, \underline{v}_i = \omega r_i \hat{t}_*$
$\underline{x} = (x_i + v_i t + \frac{1}{2} a t^2)\hat{x}$	$\underline{\Theta} = (\Theta_i + \omega_i t + \frac{1}{2} \alpha t^2)\hat{z}$
$v^2 = v_i^2 + 2a^2(x - x_i)$	$\omega^2 = \omega_i^2 + 2\alpha^2(\Theta - \Theta_i)$
	Displacement along c
	$\Delta S = r\Delta\Theta$
$M$ (Mass)	$I = \Sigma M_i r_i^2$ (Moment of Inertia)**
$M \underline{a} = \Sigma \underline{F}_i$	$I \underline{\alpha} = \Sigma \underline{\tau}_i$
At that point	About same axis as $I$
At that time	

\*\* $I$  measures the manner in which the mass is distributed around the axis so  $\Sigma \underline{\tau}_i$  must also be calculated using the same axis.

N.B.  $I$  plays same role for rotation as  $M$  plays for translation. To have  $\underline{\alpha}$  you must provide torque  $\underline{\tau} = I \underline{\alpha}$ .  
To have  $\underline{a}$  you must provide force  $M \underline{a} = \underline{F}$ .

For a rigid body one can define a center of gravity and show that it is the same as the center of mass.

$$\underline{r}_{cm} = \frac{\sum m_i \underline{r}_i}{\sum m_i}$$

Consider a rigid body placed some distance above the Earth.

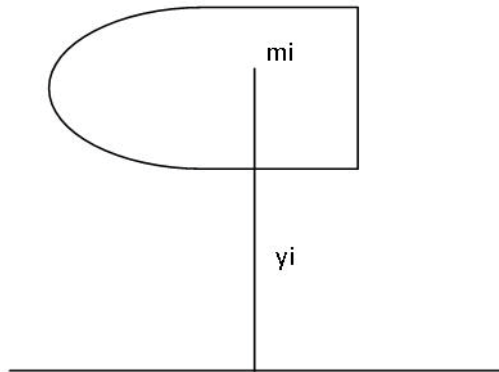

1. Each mass  $m_i$  experiences a force

$$\underline{w}_i = -m_i g \hat{y}$$

Total force on rigid body

$$\begin{aligned} \underline{w} &= \sum \underline{w}_i = -\sum m_i g \hat{y} \\ &= -Mg \hat{y} \end{aligned}$$

as if it was a single object of mass  $M$ .

2. Each mass  $m_i$  has potential energy

$$P_g(i) = m_i g y_i$$

Total potential energy

$$P_g = \sum m_i g y_i = M g y_{cm}$$

Since  $y_{cm} = \frac{\sum m_i y_i}{\sum m_i}$

As if it was a single mass  $M$  located at the center of mass of the rigid body.

# 19 Rolling Without Slip; etc

A particularly interesting case of rotation arises when a ring or disk or cylinder or sphere rolls along a solid surface.

## Case I: Rolling without slipping

Consider the case where surface is horizontal and the roller has a constant velocity  $\underline{V}_C = V_C \hat{x}$  at its center

$$CP = R$$

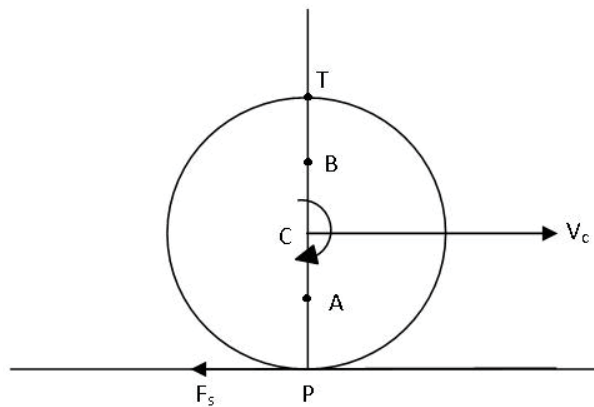



## Sharp Minds - Bright Ideas!

Employees at FOSS Analytical A/S are living proof of the company value - First - using new inventions to make dedicated solutions for our customers. With sharp minds and cross functional teamwork, we constantly strive to develop new unique products - Would you like to join our team?

FOSS works diligently with innovation and development as basis for its growth. It is reflected in the fact that more than 200 of the 1200 employees in FOSS work with Research & Development in Scandinavia and USA. Engineers at FOSS work in production, development and marketing, within a wide range of different fields, i.e. Chemistry, Electronics, Mechanics, Software, Optics, Microbiology, Chemometrics.

**We offer**  
*A challenging job in an international and innovative company that is leading in its field. You will get the opportunity to work with the most advanced technology together with highly skilled colleagues.*

*Read more about FOSS at [www.foss.dk](http://www.foss.dk) - or go directly to our student site [www.foss.dk/sharpminds](http://www.foss.dk/sharpminds) where you can learn more about your possibilities of working together with us on projects, your thesis etc.*

The Family owned FOSS group is the world leader as supplier of dedicated, high-tech analytical solutions which measure and control the quality and production of agricultural, food, pharmaceutical and chemical products. Main activities are initiated from Denmark, Sweden and USA with headquarters domiciled in Hillerød, DK. The products are marketed globally by 23 sales companies and an extensive net of distributors. In line with the corevalue to be 'First', the company intends to expand its market position.



Dedicated Analytical Solutions

FOSS  
 Slangerupgade 69  
 3400 Hillerød  
 Tel. +45 70103370  
[www.foss.dk](http://www.foss.dk)



$\underline{V}_C$  is constant so acceleration  $\underline{a} = 0$ . No force involved. If there is no SLIP, the velocity at the point of contact P must be **ZERO** at ALL times. That is, the point on the circle which comes into contact with the surface changes with time but at the instant of contact  $\underline{V}_P = 0$  always.

To achieve this, the object must have an angular velocity  $\underline{\omega}$  such that the tangential velocity  $\underline{V}_t$  at P, due to the rotation, is exactly equal and opposite to  $\underline{V}_C$ .

This will ensure that  $\underline{V}_P = \underline{V}_C + \underline{V}_t = 0$

$$\underline{V}_C \hat{x} - R\omega \hat{x} = 0$$

$$\omega = \frac{V_C}{R}$$

and for the case shown in the figure

$$\underline{\omega} = -\frac{V_C}{R} \hat{z}$$

$\underline{\omega}$  is constant so  $\underline{\alpha} = 0$  [NO TORQUE]

It is interesting to ask what are the velocities at the points A, C, B and T in the roller.

(AC =  $\frac{R}{2}$ )  $\underline{V}_A = \underline{V}_C - \frac{R\omega}{2} \hat{x} = \frac{V_C}{2} \hat{x}$   
 $\underline{V}_C = \underline{V}_C$

(BC =  $\frac{R}{2}$ )  $\underline{V}_B = \underline{V}_C - \frac{R\omega}{2} \hat{x} = \frac{3}{2} V_C \hat{x}$   
 $\underline{V}_T = \underline{V}_C + R\omega \hat{x} = 2 V_C \hat{x}$

**Case II:** Let us put our roller on an inclined plane and let it roll down the incline without slipping.

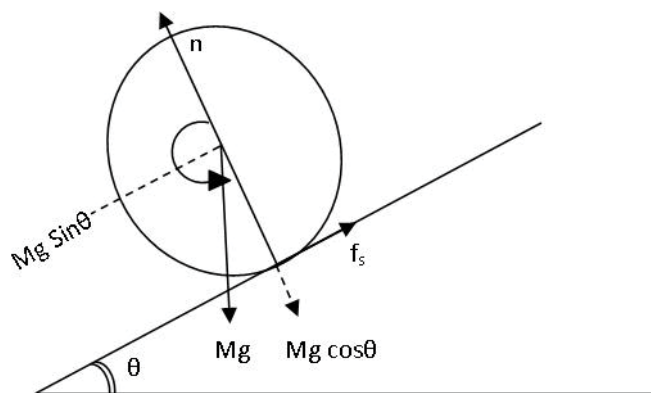

Now it will have both a linear acceleration and an angular acceleration. We have drawn all the effective forces acting on the roller.

For the linear acceleration

$$(M \underline{a} = \sum \underline{F}_i) \quad - Ma = -Mg \sin\theta + f_s \quad \rightarrow (1)$$

For the angular acceleration

$$(I \underline{\alpha} = \sum \underline{\tau}_i) \quad - I\alpha = -R f_s \quad \rightarrow (2)$$

Since there is no slip, velocity and acceleration at P must be ZERO at all times and this requires

$$\alpha = \frac{a}{R} \quad \rightarrow (3)$$

From (2) and (3)

$$f_s = \frac{I \alpha}{R} = \frac{I a}{R^2}$$

and substituting in (1)

$$Ma = Mg \sin\theta - \frac{I a}{R^2}$$

$$a = \frac{g \sin\theta}{1 + \frac{I}{M R^2}} \quad \rightarrow (4)$$

Moments of Inertia

Ring  $I = M R^2$

Disk  $I = \frac{M R^2}{2}$

Cylinder  $I = \frac{M R^2}{2}$

Sphere (hollow)  $I = \frac{2}{3} M R^2$

Sphere (solid)  $I = \frac{2}{5} M R^2$

Hence  $a$  is independent of  $M$  and  $R$ . It only depends on how mass is distributed around the axis of rotation.

Clearly, the ring has the smallest acceleration

$$\underline{a}_{ring} = \frac{-g \sin \theta}{2} \hat{x}$$

and the solid sphere has the largest acceleration

$$\underline{a}_{s.s.} = \frac{-g \sin \theta}{1.4} \hat{x}$$

Next, it must be realized that the static friction force cannot exceed  $\mu_s n$

Because  $f_s \leq \mu_s n$

So  $f_s \leq \mu_s Mg \cos \theta$

**gaiteye**<sup>®</sup>  
Challenge the way we run

**EXPERIENCE THE POWER OF  
FULL ENGAGEMENT...**

.....

**RUN FASTER.  
RUN LONGER..  
RUN EASIER...**

**READ MORE & PRE-ORDER TODAY  
WWW.GAITEYE.COM**

From Eq (1) and Eq (4)

$$\begin{aligned}
 f_s &= Mg \sin \theta - Ma \\
 &= Mg \sin \theta \left[ 1 - \frac{1}{1 + \frac{I}{MR^2}} \right] \\
 &= Mg \sin \theta \left[ \frac{\frac{I}{MR^2}}{1 + \frac{I}{MR^2}} \right]
 \end{aligned}$$

So if we start increasing  $\theta$  eventually  $f_s$  becomes equal to its largest value and the roller will slip

$$Mg \sin \theta \left[ \frac{\frac{I}{MR^2}}{1 + \frac{I}{MR^2}} \right] = \mu_s Mg \cos \theta$$

$$\tan \theta = \mu_s \left[ \frac{1 + \frac{I}{MR^2}}{\frac{I}{MR^2}} \right]$$

Ring will be the first to slip  $[\tan \theta = 2\mu_s]$

**Note**

In the above motion, the force of gravity provided the linear acceleration and  $f_s$  provided the torque.

**Case III:** It is interesting to compare this with the way your automobile gets going on a horizontal surface. The tires are

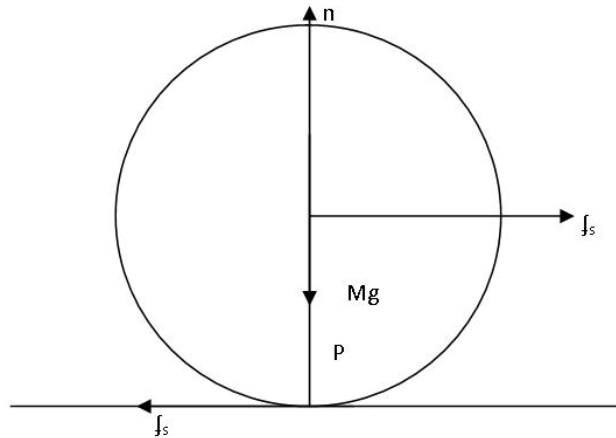

fairly complex but we will treat them as rigid bodies (rings). We need static friction (as anyone who has tried to get going on an icy road knows, the tires spin in place). But now the **Torque** is provided by the **engine** (as you engage the gear) and the tire pushes back on the road with  $f_s$  and by Newton's Third Law the road pushes the car forward. Again

$$f_s \leq \mu_s n \quad (n = Mg)$$

$$f_s \leq \mu_s Mg$$

and as always  $M \underline{a} = \underline{F} = \underline{f_s}$

so

$$\boxed{a \leq \mu_s g}$$

Maximum acceleration is  $\mu_s g$  in magnitude.



**Case IV:** After comparing case I and case IV you can begin to understand why while driving on a slippery road it is recommended that one maintains a constant speed ( $\underline{F} = 0$ ) and **definitely** must avoid excessive use of acceleration/ brake ( $\underline{F} \neq 0$ ).

**Case V:** When you go bowling you throw the ball so that when it arrives on the Shute surface it has a linear velocity  $V_1 \hat{x}$  and it slips along the surface. However, once it touches the surface kinetic friction comes into play. Let us see how this leads to rolling without slip. We will take the general case of the roller being sphere, ring, or cylinder.

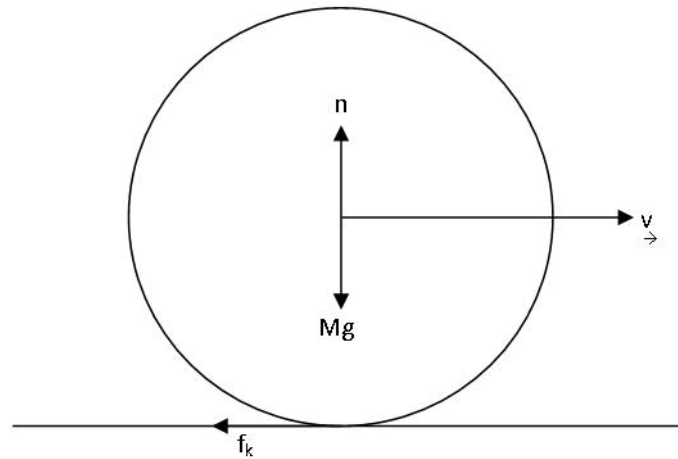

# The Wake

the only emission we want to leave behind

Low-speed Engines Medium-speed Engines Turbochargers Propellers Propulsion Packages PrimeServ

The design of eco-friendly marine power and propulsion solutions is crucial for MAN Diesel & Turbo. Power competencies are offered with the world's largest engine programme – having outputs spanning from 450 to 87,220 kW per engine. Get up front! Find out more at [www.mandieselturbo.com](http://www.mandieselturbo.com)

Engineering the Future – since 1758.

## MAN Diesel & Turbo



There is only one force acting on the roller

$$\begin{aligned} \underline{f}_k &= -\mu_k Mg \hat{x} & [n - Mg = 0] \\ \text{so } \underline{a} &= -\mu_k g \hat{x} \\ \text{and } \underline{v} &= (v_i - \mu_k g t) \hat{x} \end{aligned}$$

However, now there is also a torque about the axis through the center

$$\underline{\tau} = -R f_k \hat{z}$$

so there is an angular acceleration

$$[I \underline{\alpha} = \underline{\tau}] \quad \underline{\alpha} = \frac{-R f_k \hat{z}}{I}$$

where I is the moment of Inertia.

The angular velocity

$$\underline{\omega} = 0 - \frac{R f_k t \hat{z}}{I}$$

$$\underline{\omega} = 0 - \frac{R f_k t \hat{z}}{I}$$

and to get the condition for case I  $\left[ \omega = \frac{V}{R} \right]$ , we can look for time  $t_1$  when

$$v_i - \mu_k g t_1 = + \frac{\mu_k Mg R^2 t_1}{I}$$

$$t_1 = \frac{v_i}{\mu_k g \left[ 1 + \frac{M R^2}{I} \right]}$$

Notice  $t_1$  is also independent of M and R since

$$I = (\text{const}) \times MR^2 \text{ for all rollers.}$$

At later times we have pure roll,  $\underline{v} = \text{const.}$ ,  $\underline{\omega} = \text{const.}$  and there is no force or torque on the roller (case I).

## 20 Conservation of Angular Momentum – Keplers Laws

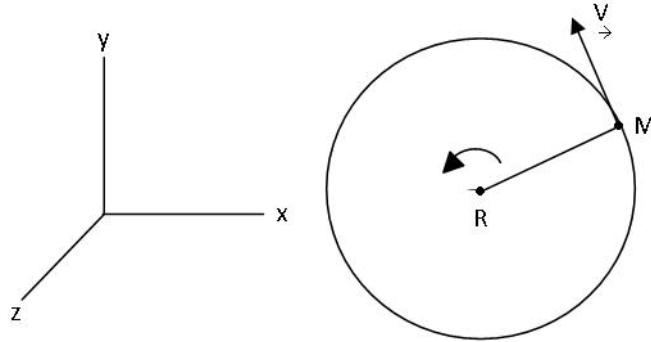

A single mass  $m$  moving on a circle of radius  $R$  at a uniform velocity has a tangential velocity

$$\underline{v} = R\omega\hat{\tau}$$

It therefore has a linear momentum

$$\underline{p} = MR\omega\hat{\tau}$$

The angular momentum of this object is defined by  $\underline{\ell} = \underline{r} \times \underline{p}$  where  $\underline{r} = R\hat{r}$ , so  $\underline{\ell}$  is  $\perp$  to the plane of the circle and will be along  $\pm\hat{z}$

$$\underline{\ell} = \pm MR^2\omega\hat{z}$$

If a tangential force is applied to  $M$

$$M\underline{a}_t = \underline{F}_t$$

and there will be a torque about  $z$ ,  $\underline{\tau} = \underline{r} \times \underline{F}_t$ , and it will have an angular acceleration  $\underline{\alpha}$

$$\underline{a}_t = R\alpha\hat{\tau}$$

Now  $\underline{\tau} = \pm RMa\hat{z} = \pm MR^2\alpha\hat{z}$

$$= \pm MR^2 \frac{\Delta\omega}{\Delta t} \hat{z} = \frac{\Delta\underline{\ell}}{\Delta t}$$

That is, if you want angular momentum to change with time you must apply a torque Newton's Law for rotation in terms of angular momentum.

Next, apply it to a rigid body rotation  $\underline{\omega}$  and  $\underline{\alpha}$  are common but  $i$ th mass has

$$\underline{v}_i = r_i \omega \hat{t}$$

$i$  th mass has angular momentum

$$\underline{\ell}_i = m_i r_i^2 \omega \hat{z} \quad \text{for C.C.W. rotation}$$

right hand rule  $\left\{ \begin{array}{l} \underline{r}_i \text{ along thumb} \\ \underline{p}_i \text{ '' fingers} \\ \underline{\ell}_i \perp \text{ palm} \end{array} \right.$

I joined MITAS because  
I wanted **real responsibility**

The Graduate Programme  
for Engineers and Geoscientists  
[www.discovermitas.com](http://www.discovermitas.com)





**Month 16**  
I was a construction supervisor in the North Sea advising and helping foremen solve problems

Real work  
International opportunities  
Three work placements







Total angular momentum of Rigid Body

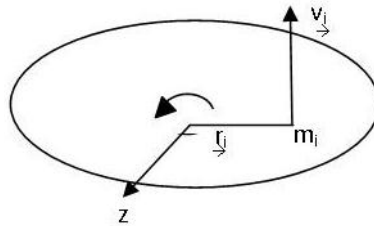

$$\underline{L} = \sum m_i r_i^2 \underline{\omega}$$

$$= I \underline{\omega}$$

compare this to the total linear momentum

$$\underline{p} = M \underline{v}$$

So again I replaces M and  $\omega$  replaces v.

### Conservation Laws

Linear Mom<sup>m</sup>

$$\underline{F}_{ext} = 0$$

$$\underline{p} = const.$$

Angular Mom<sup>m</sup>

$$\underline{\tau}_{ext} = 0$$

$$\underline{L} = const.$$

Let us apply this to motion of planets around sun in circular orbits kepler's law: (i) PLANETS MOVE IN PLANAR ORBITS. (ii) As planet goes around the sun, the radius sweeps out equal areas in equal intervals of time.

radius  
vector  
 $\underline{r} = r_p$

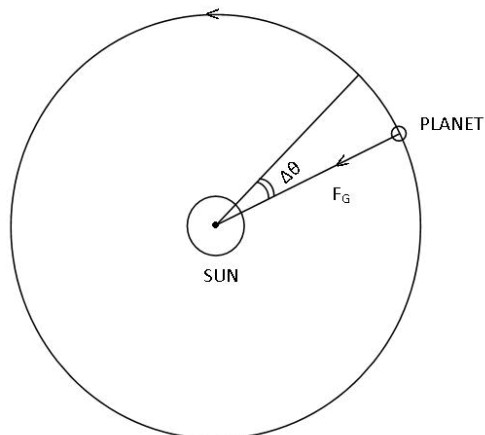

The only force acting on the planet is the Gravitational force due to the sun

$$\underline{F}_G = -\frac{GM_s M_p}{r_p^2} \hat{r}$$

If we take the torque about an axis through the sun

$$\underline{\tau}_p = \underline{r} \times \underline{F}_G = 0 \quad \text{because } [\hat{r} \times \hat{r}] = 0$$

Hence angular momentum of planet around this axis must be constant

$$\underline{L}_p = M_p r_p^2 \omega_p \hat{z}$$

Since  $\underline{L}_p$  cannot change direction, orbit must lie in xy-plane.

[It is also a plane because  $\underline{F}_G$  is only along  $\hat{r}$ ]. Next, consider that the radius rotates through angle  $\Delta\theta$  in time  $\Delta t$ .

Area swept out by  $\underline{r}$  becomes

$$\Delta A = \frac{1}{2} r_p^2 \Delta\theta$$

and area swept per second

$$\begin{aligned} \frac{\Delta A}{\Delta t} &= \frac{1}{2} r_p^2 \frac{\Delta\theta}{\Delta t} \\ &= \frac{1}{2} r_p^2 \omega = \frac{1}{2} \frac{L_p}{M_p} \\ &= \text{const.} \end{aligned}$$

Because magnitude of  $L_p$  is constant.

# 21 Thermodynamics – Dynamics + One Thermal Parameter

## THERMODYNAMIC SYSTEM

Consists of some amount of solid, liquid, gas separated from the surroundings by a “Boundary” Wall.

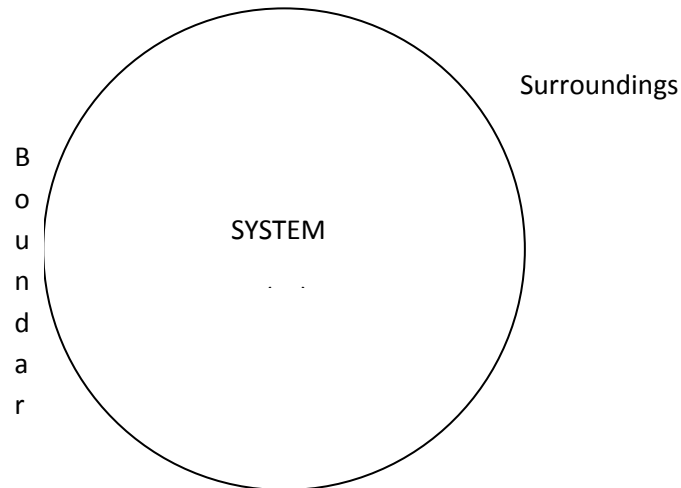

The collage features four images: a person working at a computer, a man holding a document, and two women talking. The collage is overlaid with a blue wave graphic.

[www.job.oticon.dk](http://www.job.oticon.dk)

**oticon**  
PEOPLE FIRST



## TWO KINDS OF BOUNDARIES ARE OF INTEREST

### Conducting Boundary (C)

In this case the system is very sensitive to its surroundings.

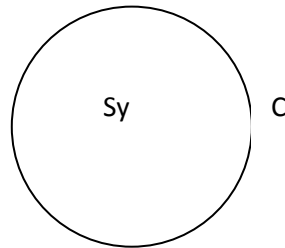

### Insulating Boundary (I)

The system is totally isolated from its surroundings.

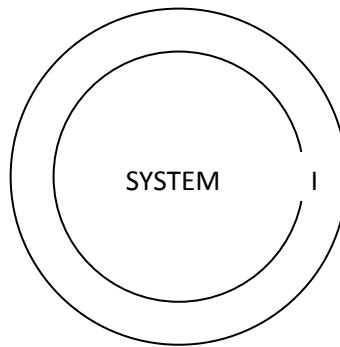

## PROPERTIES OF A THERMODYNAMIC SYSTEM

To start with, Sy has an extent so the very first property is the amount of space it occupies: Volume  $V$

This, of course, includes the special cases of length  $\ell$  and area  $A$ .

Any attempt to change  $V$  makes us immediately aware that the material inside (even a gas) exerts a force on the wall. This leads us to the definition of the second property-PRESSURE

$P$  = Force per unit area on wall

$$= \frac{F}{A}$$

[Pressure  $ML^{-1}T^{-2}$   $N/m^2$  Scalar (for us)]



Next, if system has no external force acting on it, there must be equilibrium everywhere.

If we imagine “looking” at a small cube inside, it is realized that for  $\equiv m$  to prevail the pressure must be isotropic (same in all directions) and uniform (same at all points). So for an isolated system  $V$  and  $P$  are single valued.

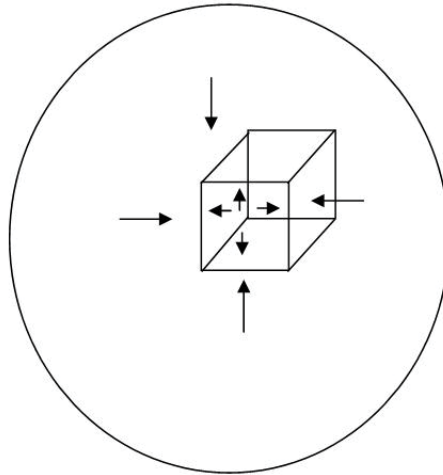

If we bring our system close to the Earth the picture changes because every mass point  $m$  inside experiences a force  $-mg\hat{y}$  so if pressure were the same at all values of  $y$  (height above surface of Earth) the system would not be in  $\equiv m$ .

### VARIATION OF PRESSURE IN A FLUID (GAS/LIQUID) NEAR EARTH

Pressure is force per unit area. If we have fluid in a container far away from Earth then in equilibrium the pressure has to be isotropic and uniform otherwise there will be unbalanced forces and the fluid particles will not be stationary. If you bring the fluid near Earth, the situation changes because the earth pulls every mass toward its center with the force

$$\underline{W}_g = -Mg\hat{y}$$

So the fluid pressure must adjust itself if a layer of fluid located between  $y$  and  $(y + \Delta y)$  is to be in equilibrium.

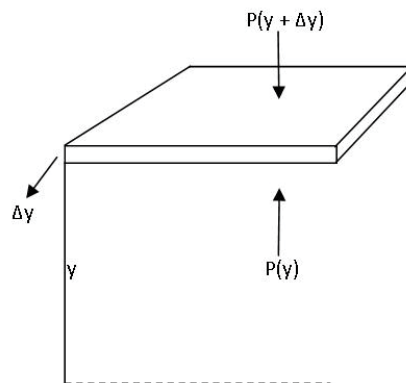

Consider the layer of Area  $A$

Let the pressures be

$P(y)$  at  $y$

and

$P(y + \Delta y)$  at  $(y + \Delta y)$

# INNOVATIVE LIKE YOU.

If you're hoping for a truly modern education, one where you're encouraged to speak your mind and to think long-term, both when it comes to your own future and the future of the planet. Then the University of Gothenburg is the place for you.

Study a Master's programme in Gothenburg, Sweden | [www.gu.se/education](http://www.gu.se/education)



Click on the ad to read more

If density of fluid is  $\rho$

$$\text{Mass of fluid in layer} = \rho A \Delta y.$$

There are three forces on the layer

$$\underline{F}_1 = P(y) A \hat{y}$$

$$\underline{F}_2 = -P(y + \Delta y) A \hat{y}$$

$$\underline{W}_g = -\rho A \Delta y g \hat{y}$$

$$\begin{aligned} \text{For } \equiv m \quad \underline{F}_1 + \underline{F}_2 + \underline{W}_g &= 0 \\ P(y) A - P(y + \Delta y) A - \rho A \Delta y g &= 0 \\ P(y + \Delta y) - P(y) &= -\rho g \Delta y \end{aligned} \quad (1)$$

That is, pressure must reduce as  $y$  increases so that the weight of the layer is supported. Liquids are incompressible,  $\rho = \text{constant}$  hence pressure difference between top and bottom of a column of liquid of height  $h$  becomes

$$P_{\text{top}} - P_{\text{bottom}} = -\rho g h$$

or

$$P_{\text{bottom}} = P_{\text{top}} + \rho g h$$

Further, because of all the air above the liquid column  $P_{\text{top}} = P_{\text{air}}$  and hence

$$P_{\text{bottom}} = P_{\text{top}} + \rho g h \quad (\text{Liquid})$$

Note  $\rightarrow$  In a gas the situation is more complicated because the density is a function of pressure.

Note  $\rightarrow$  The important point about Eq (1) is that if  $\Delta y$  is small one can still pretend that a single value of  $P$  is adequate to describe the system.

## THERMAL PARAMETER

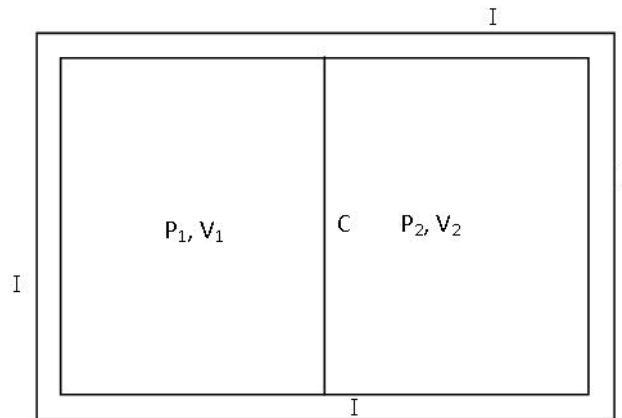

To proceed further we need two systems with a conducting wall between them. That is, they can “talk” to one another but are isolated from all other surroundings.

Before we bring them together, let their parameters be  $P_1, V_1$  and  $P_2, V_2$ , respectively. Two things can happen:

1. There is no change in either system even though

$$P_1 \neq P_2$$

$$V_1 \neq V_2$$

- II. Both systems change but if we are patient, all changes stop

$$P_1, V_1 \rightarrow P_1', V_1'$$

$$P_2, V_2 \rightarrow P_2', V_2'$$

but again

$$P_2' \neq P_1'$$

$$V_2' \neq V_1'$$

**CONCLUSIONS TO BE DRAWN**

- a) If there is no change it is reasonable to claim that the systems are in equilibrium. This is a new kind of  $\equiv m$  called:

THERMAL  $\equiv m$

In case I above systems were in  $\equiv m$  when we began. In case II they got to  $\equiv m$  after a while.

The crucial observation is that equilibrium prevails WHEN NEITHER THE PRESSURES NOR THE VOLUMES ARE EQUAL. INDEED, THE EXPERIMENT TEACHES US THAT P and V ARE **IRRELEVANT FOR THERMAL  $\equiv m$** .

- b) Even more important we are learning that there must exist another property besides P and V whose value must be the same for both the systems to ensure  $\equiv m$ .

THIS NEW PROPERTY IS CALLED: **TEMPERATURE**

TWO THERMODYNAMIC SYSTEMS CAN BE IN EQUILIBRIUM IF AND ONLY IF THEIR TEMPERATURES ARE EQUAL.



Sweden  
Sverige

Linköping University –  
innovative, highly ranked,  
European

Interested in Computer Science? Kick-start your career  
with an English-taught master's degree.

→ Click here!

**li.u** LINKÖPING  
UNIVERSITY

**COROLLARY:** A SINGLE SYSTEM CAN BE IN  $\equiv m$  ONLY IF THE TEMPERATURE IS THE SAME AT ALL POINTS IN THE SYSTEM.

[TEMPERATURE IS A DIMENSION IN ITS OWN RIGHT Temp  $\theta^1$  Degree SCALAR.]

### THERMOMETER - THERMOSTAT

An interesting variation of the above expt. is when you make one system very large and the other very small. When you bring them together the small system changes a lot while the large system changes very little. You have constructed a thermometer and a thermostat. The change in the small system can be used to measure the temperature of the large one.

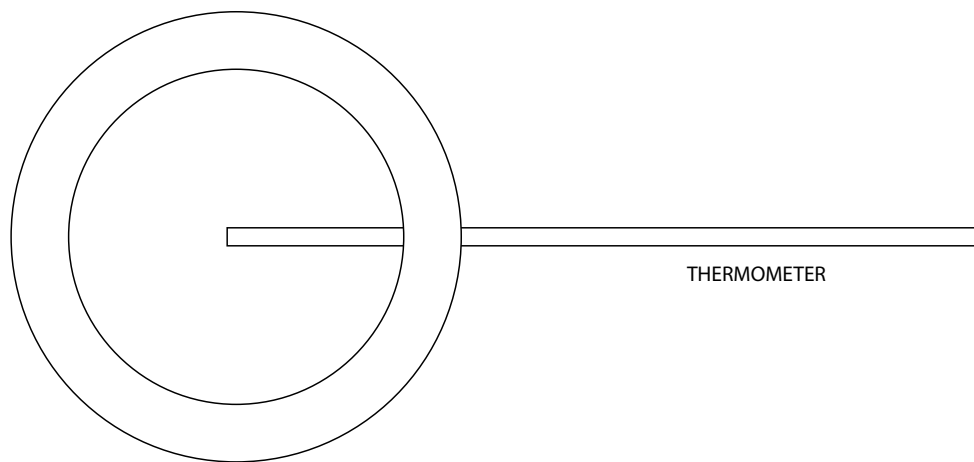

# 22 Temperature ( $\theta$ )

Now we have four fundamental dimensions:

Length, Time, Mass, Temperature  
L    T    M     $\theta$

$\theta$  is a dimension you cannot derive it from L, T and M.

Temperature Scales: The units of  $\theta$  were historically determined by reference to the properties of water at normal atmospheric pressure ( $\sim 10^5 \text{ N/m}^2$ )

<u>Celsius</u>	<u>Fahrenheit</u>
Melting pt. of ice    0 °C	32 °F
Boiling pt. of water    100 °C	212 °F
} 100	} 180

## STUDY FOR YOUR MASTER'S DEGREE IN THE CRADLE OF SWEDISH ENGINEERING

Chalmers University of Technology conducts research and education in engineering and natural sciences, architecture, technology-related mathematical sciences and nautical sciences. Behind all that Chalmers accomplishes, the aim persists for contributing to a sustainable future – both nationally and globally.

Visit us on [Chalmers.se](http://Chalmers.se) or [Next Stop Chalmers](#) on facebook.

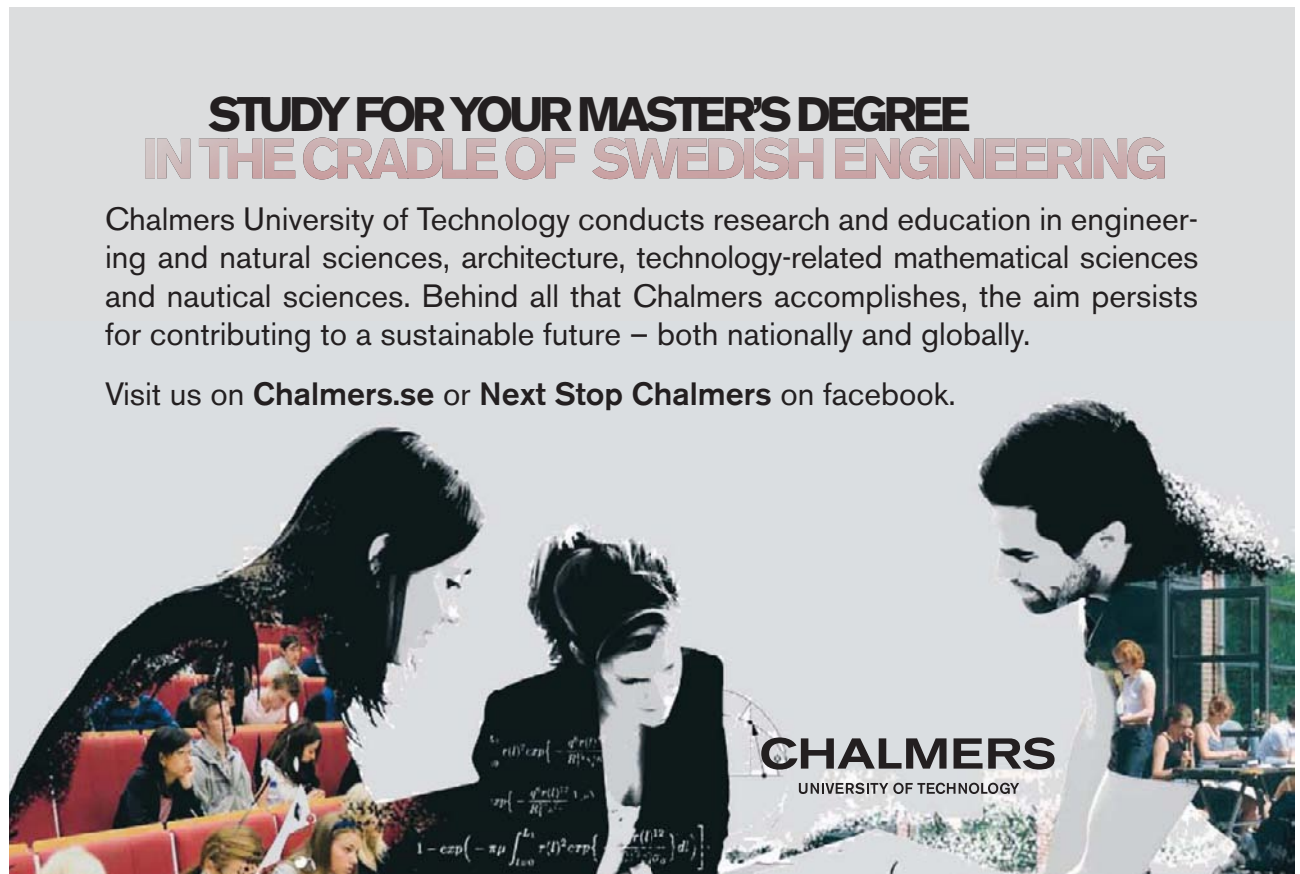

**CHALMERS**  
UNIVERSITY OF TECHNOLOGY



Hence a temperature difference of 5 °C is equal to 9 °F and therefore the readings on the two scales are related by the equation  $\frac{F-32}{9} = \frac{C}{5}$

For example, the normal body temperature of 98.6 °F (only in the USA) is

$$\frac{5(98.6 - 32)}{9} = 37^\circ\text{C (in France)}$$

## EFFECTS OF CHANGING $\theta$

### Solids

A solid has both shape and size so the effects of changing  $\theta$  appear on length (wire), Area (plate) and volume (parallelepiped).

**Length:** for most solids increasing the temperature causes an increase in length

$$\ell = \ell_0 [1 + \alpha (\theta - \theta_0)]$$

Where  $\alpha$  is called the coefficient of linear expansion [measured in  $[\text{°C}]^{-1}$  or  $^\circ\text{F}^{-1}$ ] and is typically about  $10^{-5} [\text{°C}]^{-1}$ .

**Area:** will involve changing two dimensions, say  $\ell$  and  $b$

$$\ell = \ell_0 [1 + \alpha (\theta - \theta_0)]$$

$$b = b_0 [1 + \alpha (\theta - \theta_0)]$$

so  $A = \ell b = \ell_0 b_0 [1 + \alpha (\theta - \theta_0)]^2$

$$= A_0 [1 + 2\alpha (\theta - \theta_0)]$$

since  $\alpha \ll 1$ .

**Volume:** Now 3 dimensions are involved

$$V = V_0 [1 + 3\alpha (\theta - \theta_0)]$$

$$= V_0 [1 + \beta (\theta - \theta_0)]$$

With  $\beta = 3\alpha$



## LIQUIDS

Liquids only have size and no shape, so only volume changes occur

$$V = V_0 [1 + \beta (\theta - \theta_0)]$$

and typically  $\beta$  is about  $10^{-4} [^{\circ}\text{C}]^{-1}$  or about 10 times the volume expansion coefficient of a solid.

It is important to note a very important and highly unusual property of water. If you cool water it will indeed contract until the temperature reaches 4 °C. ON FURTHER COOLING WATER EXPANDS by about 1 part in  $10^4$  when it starts becoming ice at

0°C. During this solidification there is a further expansion of about 10 per cent.

## GASES

Gases have neither shape nor size and therefore have to be treated separately since Volume (V), Pressure (P), and temperature ( $\theta$ ) are all interrelated.

**Temperature Const.**

For a given amount of gas, pressure and volume are inversely related (Boyle's Law). -If you double the pressure, volume becomes one half as large and vice versa. In other words,  $P V = \text{Constant}$

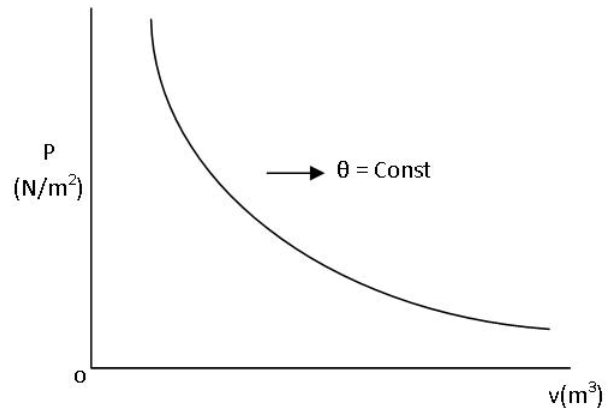

$$P = \frac{\text{Constant}}{V}$$

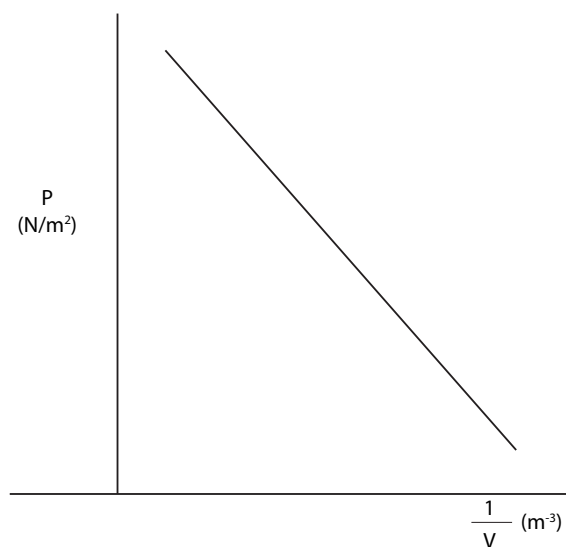

**Volume (Const.)**

Study P as a function of temperature.

For a low pressure gas you find

$$P = P_0 (1 + c\theta)$$

$$c = \frac{1}{273} (\text{°C})^{-1}$$

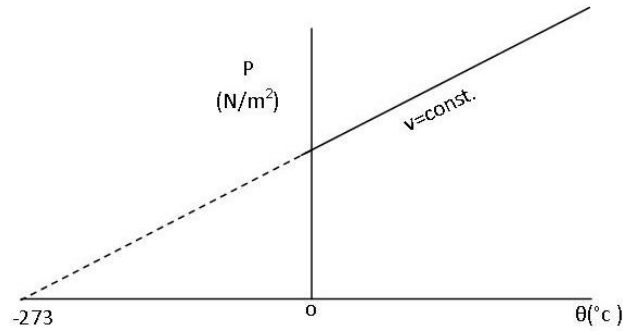

Redefine Temperature  $T = (\theta + 273) \text{ °C}$

$P \propto T$  New Scale (Vol. Const)

Kelvin scale or Ideal gas scale

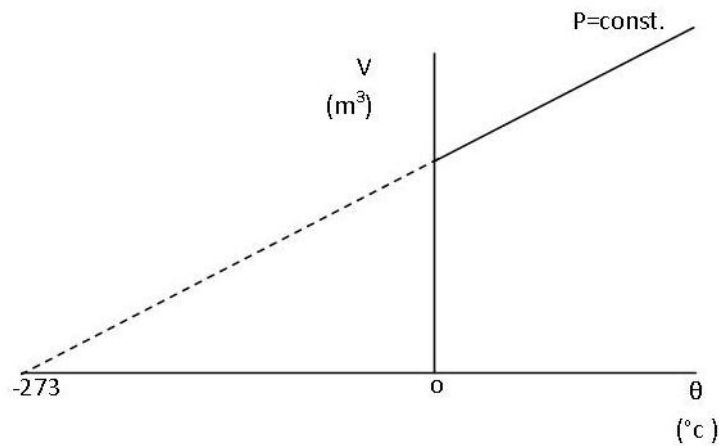

**Pressure Constant**

Now V varies as

$$V = V_0 [1 + c\theta]$$

$$c = \frac{1}{273} (\text{°C})^{-1}$$

so one can write

$$V \propto T \quad [P \text{ Constant}]$$

If we combine all three we can write

$$P V = N k_B T$$

where  $N$  = No. of gas particles in container

$k_B$  is Boltzmann's Constant

$$1.38 \times 10^{-23} \text{ Joules/Kelvin}$$

$$T \text{ is in Kelvin scale } T = [273 + \theta^\circ\text{C}]$$

Chemists write this equation as

$$P V = n R T$$

$$R = N_A k_B$$

$$N_A = \text{Avogadro's No.} = 6.02 \times 10^{23}$$

Number of particles in one mole.

**MÄLARDALEN UNIVERSITY SWEDEN**

**WELCOME TO OUR WORLD OF TEACHING!**  
INNOVATION, FLAT HIERARCHIES AND OPEN-MINDED PROFESSORS

**STUDY IN SWEDEN - CLOSE COLLABORATION WITH FUTURE EMPLOYERS**  
MÄLARDALEN UNIVERSITY COLLABORATES WITH MANY EMPLOYERS SUCH AS ABB, VOLVO AND ERICSSON

**TAKE THE RIGHT TRACK**  
GIVE YOUR CAREER A HEADSTART AT MÄLARDALEN UNIVERSITY  
[www.mdh.se](http://www.mdh.se)

**DEBAJYOTI NAG**  
SWEDEN, AND PARTICULARLY MDH, HAS A VERY IMPRESSIVE REPUTATION IN THE FIELD OF EMBEDDED SYSTEMS RESEARCH, AND THE COURSE DESIGN IS VERY CLOSE TO THE INDUSTRY REQUIREMENTS.  
HE'LL TELL YOU ALL ABOUT IT AND ANSWER YOUR QUESTIONS AT [MDUSTUDENT.COM](http://MDUSTUDENT.COM)



# 23 Heat

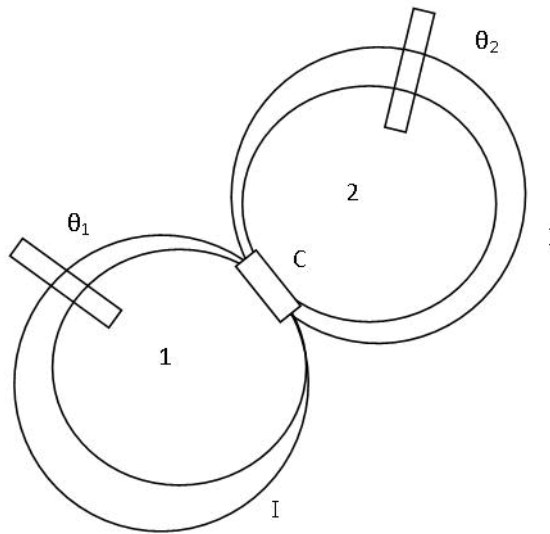

Now we know that in order to understand the experiment in which two Thermodynamic Systems are allowed to “talk” to one another through a conducting wall, we must use Temperature as the relevant variable. Once we do that, the two observations described earlier will be described by:

**Case I:**  $\theta_1 = \theta_2$  [equilibrium already]

**Case II:**  $\theta_1 \neq \theta_2$  are different but both change until they become equal and then equilibrium prevails.

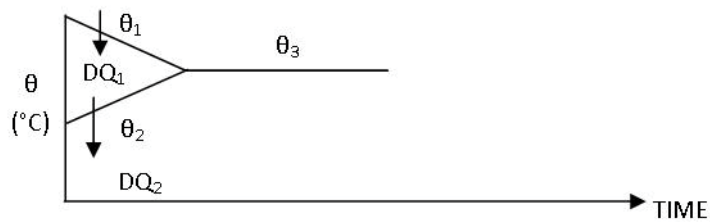

In case II we will find that invariably the warmer system (high  $\theta$ ) cools and the colder system warms until the final temperature ( $\theta_3$ ) is reached.

The next questions are why do the two temperatures change and what is exchanged between the systems to cause the changes. This brings out the definition of **Heat**: If two systems at different temperatures are separated by a conducting wall, energy will “flow” from one to the other. This Exchange of energy is called **HEAT**.

**Definition:** HEAT IS A FORM OF ENERGY WHICH IS EXCHANGED BETWEEN SYSTEMS WHEN THEY ARE AT DIFFERENT TEMPERATURES AND NO AGENCY IS BEING USED TO PREVENT THE EXCHANGE.

[Immediate Consequence: It is meaningless to talk about the quantity of Heat within a system.]

We use  $DQ$  to indicate that we are talking about Exchange only. Later, we will learn that this exchange depends on how the process is carried out and that is why we use a capital “D”.

Of course, energy must be conserved so in the above experiment heat lost by the warmer system must be exactly equal to that gained by the cooler system. That is

$$DQ_1 + DQ_2 = 0$$

No heat is exchanged with the surroundings because the walls are insulators.

### UNIT OF HEAT

We use the properties of water to define the unit of heat. In order to change the temperature of one gram of water from  $14.5^\circ\text{C}$  to  $15.5^\circ\text{C}$ , it will take 1 calorie of heat [Heat  $\text{M L}^2 \text{T}^{-2}$  cal scalar].

A kilocalorie requires 1 kg of water.

Next, for any solid or liquid, it turns out that the quantity of heat-required to change the temperature depends on the mass, hence one can write

$$DQ = m C (\theta_f - \theta_i)$$

where  $C$  is the specific heat (quantity of heat required to change temperature of a kilogram of material by one degree).

Determination of  $C$  gets us into the Science of Calorimetry. A calorimeter is a device whose walls are totally insulating. Our two systems can then be a quantity  $m_w$  of water at temperature  $\theta_w$  and an amount  $m$  of material whose specific heat  $C$  we want to measure. We heat it to a temperature  $\theta_i$ , drop it into water, close the calorimeter and wait for equilibrium. Then

$$m C (\theta_f - \theta_i) + m_w C_w (\theta_f - \theta_w) = 0$$

and calculate  $C$ . For example, Lead has  $C = 0.0305 \text{ cal/g } ^\circ\text{C}$ .

However, transference of heat can have another effect. The temperature does not change but the solid turns into a liquid (or vice verse) or a liquid turns into vapor. That brings into play Latent Heat

$$D Q = m L$$

L: quantity of heat required to change the state [Sol  $\rightarrow$  Liq, Liq  $\rightarrow$  vapor] without changing the temperature.

Examples: It takes 80 calories/g to change ice into water at 0°C and nearly 540 calories to change 1g of water into 1g of steam at 100°C.

### Mechanical Equivalent

When you rub your hands together, they get warmer but NO HEAT IS INVOLVED. What you have discovered is that a certain amount of mechanical (frictional) work will produce the same effects as heat. Indeed, we have learned that 4.186 Joules of mechanical work will MIMIC the effects of 1 calory of heat, BUT IT IS NOT HEAT!



## Develop the tools we need for Life Science Masters Degree in Bioinformatics

A 3D rendered face of a woman's head, composed of a grid of DNA base pairs (A, T, C, G) in various colors (yellow, orange, red, blue). The background is a dark, textured surface with more DNA sequences scattered across it.

Bioinformatics is the exciting field where biology, computer science, and mathematics meet.

We solve problems from biology and medicine using methods and tools from computer science and mathematics.

Read more about this and our other international masters degree programmes at [www.uu.se/master](http://www.uu.se/master)



# 24 Pressure of a Gas – Kinetic Energy

**Question:** Why does a gas exert pressure on the walls of its container?

**Answer:** At a finite temperature the atoms of the gas are all in random motion. Each time an atom of mass  $m$  and velocity  $+u\hat{x}$  for example has an elastic collision with the wall, it delivers an impulse

$$+ 2mu\hat{x}$$

to the wall. If we calculate the number of collisions per second ( $n_s$ ),  $(n_s \times 2mu)$  is the change in the momentum of the wall per second, which is a

## FORCE

If you divide the force by the area of the wall on which collisions occur you have

$$pressure = \frac{Force}{Area}$$

**Proof:** Consider a gas which has  $N$  atoms of mass  $m$  in a container of volume  $V$ .

$$Number\ density\ n = \frac{N}{V}$$

The atoms are in random motion that means they have a distribution of velocities

# per $m^3$	Velocity
$n_1$	$\underline{c_1}$
$n_2$	$\underline{c_2}$
.	.
.	.
.	.
.	.
$n_i$	$\underline{c_i}$
$\Sigma n_i = n$	



Since motion is totally random **average velocity** must be ZERO!

$$\langle \underline{c} \rangle = \frac{\sum \underline{c}_i n_i}{\sum n_i}$$

Let us consider the  $n_i$  atoms whose velocity is  $\underline{c}_i$  and focus on the x-component of their velocity  $u_i$  and have it collide with a vertical wall.

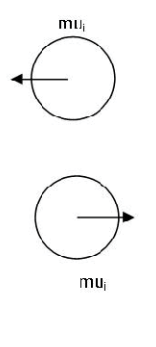

As discussed previously. Since mass of wall is enormous compared to atom, wall can pick up momentum but **NO** kinetic energy so

$$\Delta \underline{p}_{wall} = +2mu_i \hat{x}$$

Construct a parallel piped area  $A$  and height  $u_i \Delta t$ .

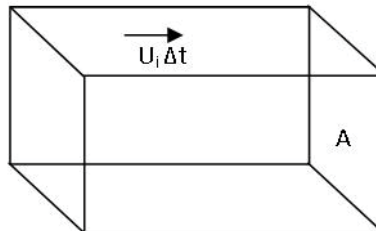

It is clear that all  $i$  type particles travelling to the right (hence  $\frac{n_i}{2}$  since motion is random) will hit the wall at time  $\Delta t$

$$\# \text{ of collisions in time } \Delta t = \frac{n_i}{2} u_i \Delta t A$$

$$\# \text{ of collisions per sec} = \frac{n_i u_i A}{2}$$

$$\begin{aligned} \text{Mom}^m \text{ delivered to wall per sec} &= \frac{2mu_i n_i u_i A}{2} \\ &= mu_i n_i u_i A \end{aligned}$$

That is the force on the wall due to type  $i$  particles

$$F_i = mn_i u_i^2 A$$

Pressure due to them is

$$P_i = \frac{F_i}{A} = mn_i u_i^2$$

Pressure due to all  $n$  atoms

$$P = \sum P_i = \sum mn_i u_i^2$$

$$= nm \langle u^2 \rangle$$

Since average of  $u^2$  is

$$\langle u^2 \rangle = \frac{\sum n_i u_i^2}{n}$$

Since motion is random if  $u$ ,  $v$ ,  $w$  are the components of velocity along  $x$ ,  $y$ ,  $z$

$$\langle u^2 \rangle = \langle v^2 \rangle = \langle w^2 \rangle = \frac{\langle c^2 \rangle}{3}$$

Because  $\langle u^2 \rangle + \langle v^2 \rangle + \langle w^2 \rangle = \langle c^2 \rangle$

So pressure

$$P = \frac{1}{3} mn \langle c^2 \rangle$$

Of course average kinetic energy of an atom is  $K = \frac{1}{2} m \langle c^2 \rangle$

So

$$P = \frac{2}{3} \frac{K \cdot E}{vol} \quad (\text{Pressure is } \frac{2}{3} \text{ of kinetic energy per unit vol})$$

Also  $PV = Nk_B T$  from expt.  $n = \frac{N}{V}$

$$P = Nk_B T = \frac{1}{3} mn \langle c^2 \rangle$$

Hence  $\frac{1}{2} m \langle c^2 \rangle = \frac{2}{3} k_B T$

Kinetic energy stored in random motion of the atoms

We define the root mean square speed

$$v_{rms} = \sqrt{\langle c^2 \rangle} = \sqrt{\frac{3k_B T}{m}}$$

For example: He atoms  $m = 4 \times 1.6 \times 10^{-27} \text{ kg}$  so at room temperature  $T = 300\text{K}$

$$v_{rms} = \sqrt{\frac{3 \times 1.38 \times 10^{-23} \times 300}{4 \times 1.6 \times 10^{-27}}} = 1.4 \times 10^3 \text{ m/s}$$

Kr atoms  $v_{rms} = \frac{1.4 \times 10^3}{\sqrt{21}} \text{ m/s}$

$$m = 8.4 \times 1.6 \times 10^{-27} \text{ kg}$$

$$\approx 3 \times 10^2 \text{ m/s}$$

$$m = 8.4 \times 1.6 \times 10^{-27} \text{ kg}$$

$$\approx 3 \times 10^2 \text{ m/s}$$

He
Kr
Mixture

same  
Kinetic  
Energy

**Nido**

**Luxurious accommodation**

**Central zone 1 & 2 locations**

**Meet hundreds of international students**

**BOOK NOW and get a £100 voucher from voucherexpress**

**Nido Student Living - London**

**Visit [www.NidoStudentLiving.com/Bookboon](http://www.NidoStudentLiving.com/Bookboon) for more info.**

**+44 (0)20 3102 1060**



Click on the ad to read more

# 25 Modes of Heat Transfer

I: Heat is the energy transfer or exchange caused by a temperature difference. Hence if there is a temperature difference there shall be a heat transfer whether the two locations of the temperature are separated by a solid, liquid, gas or vacuum.

The three modes are:

**Conduction:** Operates in solids and stationary liquids and gases (no stirring allowed).

**Convection:** Operates in liquids and gases due to thermal stirring.

**Radiation:** Operates in vacuum. Indeed interposition of matter impedes radiation.

## CONDUCTION

Transfer of heat occurs layer by layer. Higher temperature (higher kinetic energy) layer hands over energy to a lower temperature layer thereby causing a heat “current” to “flow” from high T to low T.

We will concentrate on the steady state situation. That is, the temperatures don't vary with time.

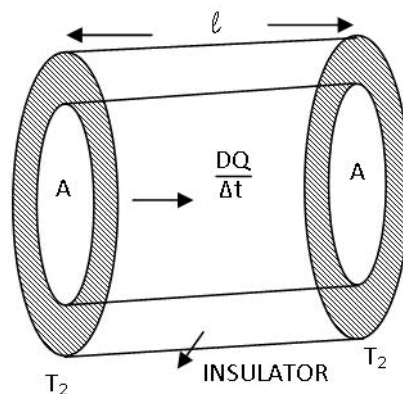

(Assume that there is no heat loss from the curved surfaces)

Consider a block of cross section  $A$  and length  $l$  where the temperatures are  $T_1$  (left face) and  $T_2$  (right face).

For example:

$$T_1 = 373 \text{ K (Steam)}$$

$$T_2 = 273 \text{ K (Ice)}$$

The heat current is equal to amount of heat flow per second

$$\frac{DQ}{\Delta t}$$

We can measure  $\frac{DQ}{\Delta t}$  by keeping track of the amount of ice melting per second (It costs 80cal/gm at 273K). Expts. will show that:

$$\frac{DQ}{\Delta t} \text{ is proportional to area } A$$

$$\frac{DQ}{\Delta t} \text{ is proportional to } \frac{1}{\ell} \text{ or } \left( \frac{1}{\Delta x} \right)$$

$$\frac{DQ}{\Delta t} \text{ is proportional to } (T_1 - T_2) \text{ or } \Delta T$$

and of course  $\frac{DQ}{\Delta t}$  is governed by the material of the block so the steady state equation for conduction becomes

$$\frac{DQ}{\Delta t} = -k A \frac{\Delta T}{\Delta x}$$

where  $k$  = Thermal Conductivity of the material  $[ML^{-1}T^{-3}\theta^{-1}]$

**Brain power**

By 2020, wind could provide one-tenth of our planet's electricity needs. Already today, SKF's innovative know-how is crucial to running a large proportion of the world's wind turbines.

Up to 25 % of the generating costs relate to maintenance. These can be reduced dramatically thanks to our systems for on-line condition monitoring and automatic lubrication. We help make it more economical to create cleaner, cheaper energy out of thin air.

By sharing our experience, expertise, and creativity, industries can boost performance beyond expectations. Therefore we need the best employees who can meet this challenge!

The Power of Knowledge Engineering

Plug into The Power of Knowledge Engineering.  
Visit us at [www.skf.com/knowledge](http://www.skf.com/knowledge)

**SKF**

Note the minus sign on the right of this equation. It **ensures** that heat always flows from high T to low T. Indeed,

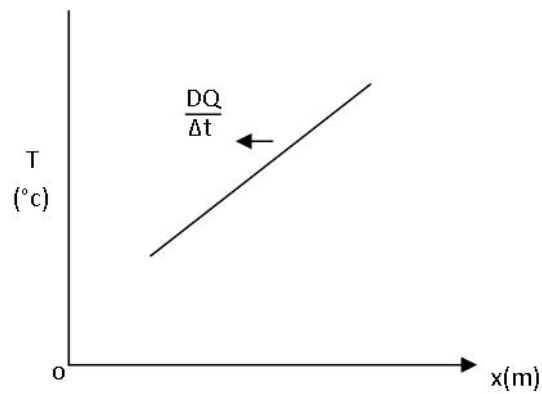
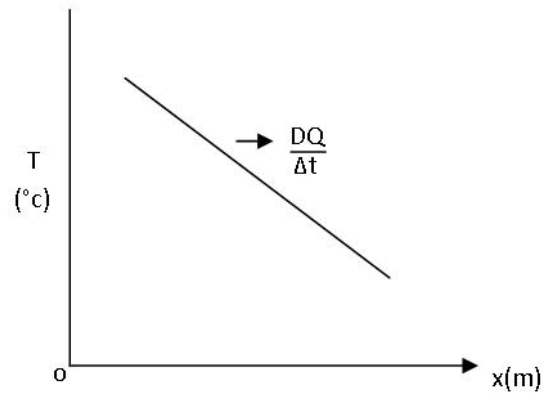

Typical  $k$  values

$$k_{cu} \approx 400 J / m / sec / ^\circ C$$

$$k_{wood} \approx 0.1 J / m / sec / ^\circ C$$

So our conducting boundary will be made of thin copper of large area while insulating boundary would need thick wood with a small area.

## CONVECTION

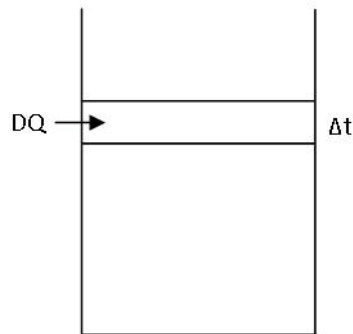

Occurs only in liquids and gases as it involves thermal stirring. There are no equations (aren't we glad!) but we can roughly understand it as follows: let us concentrate on a layer of thickness  $\Delta y$ . It is in equilibrium because the sum of the forces is equal to zero giving  $\Delta P = -\rho g \Delta y$ .

Supposing we add some heat  $DQ$  to it. The fluid expands and  $\rho$  drops, the equilibrium is disturbed, upward force becomes larger and the fluid starts moving up. This will cause the colder fluid on the top to start moving down thereby setting up thermal stirring something like

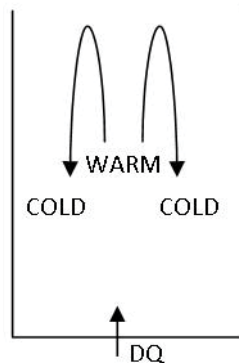

Causing a net heat current upwards. Convection is a very efficient process as the warm fluid carries energy rapidly to the colder regions while the cooler fluid quickly makes its way to the warmer spots.

Simple example of convection is the so-called "WIND CHILL FACTOR" in winter.

## RADIATION

Radiation is most effective in vacuum. It is most difficult to understand as it involves knowledge of waves. For now we imagine that when any object is at a finite temperature  $T$ , radiant heat continuously comes out of its surface because of “leakage” (i.e. transmission) each time a “wave” hits the surface from the inside.

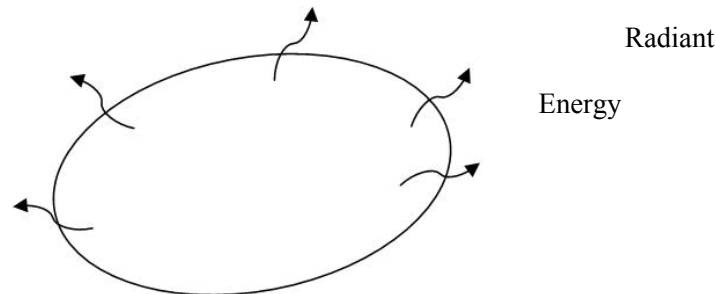

The Heat Current depends on surface Area  $A$ , nature of surface, emissivity  $e$ , the fourth power of the temperature, in Kelvin  $T$  and the universal constant  $\sigma$  (Stefan-Boltzmann)

$$\left(\frac{DQ}{\Delta t}\right)_{out} = A e \sigma T^4$$

$\sigma = 6 \times 10^{-8} \text{ W/m}^2/\text{K}^4$ . Notice, if  $T$  goes from 300K to 900,  $\left(\frac{DQ}{\Delta t}\right)$  increases by a factor of 81! Of course, if the surroundings have temperature  $T_s$  they also radiate and their energy must go through the same surface so

$$\left(\frac{DQ}{\Delta t}\right)_{in} = A e \sigma T_s^4$$

Hence

$$\left(\frac{DQ}{\Delta t}\right)_{net} = A e \sigma (T_s^4 - T^4)$$

The object will increase its  $T$  if  $T_s > T$  and will cool if  $T_s < T$ . Again, all exchange stops if  $T_s = T$ .



Further,

$$\left(\frac{DQ}{\Delta t}\right)_{net} = A e \sigma (T_s - T)(T_s + T)(T_s^2 + T^2)$$

So if  $(T_s - T) \ll T_s$  and  $T$ ,  $(T_s + T)$  and  $(T_s^2 + T^2)$  are essentially constant, yielding.

$$\left(\frac{DQ}{\Delta t}\right)_{net} \propto (T_s - T)$$

which is Newton's Law of Cooling. That is, for small temperature differences, rate of cooling, by radiation, is proportional to the temperature difference.

The emissivity  $e$  depends on surface roughness, color etc. Rough, Dark surfaces have  $e \approx 1$ . Highly polished, shiny surfaces have very low emissivity. They are shiny because they reflect thereby cutting down on the leakage.

**GET A MASTER'S DEGREE IN UMEÅ!**

- modern campus • world class research • 32 000 students
- top class teachers • ranked nr 1 in Sweden by international students

**Master's programmes:**

- Architecture
- Industrial Design
- Science
- Engineering

Download brochure here!



**UMEÅ UNIVERSITY**  
FACULTY OF SCIENCE & TECHNOLOGY



# 26 First Law of Thermodynamics

We have learnt that if a thermodynamic system has a conducting boundary (that is, it is not isolated from its surroundings) and its temperature  $T_1$  is different from that of the surroundings  $T_2$ , there will be an exchange of energy driven by the temperature difference and this energy is called heat  $DQ$ . If  $T_2 > T_1$   $DQ$  enters our system, if  $T_2 < T_1$ ,  $DQ$  leaves our system. For liquids and solids

$$DQ = mc\Delta T \quad [\text{change of temperature}]$$

$$DQ = mL \quad [\text{change of phase}]$$

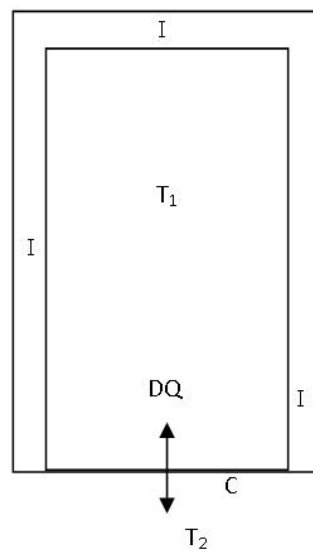

We have also learnt that we can use mechanical work to mimic the effects of heat. Indeed  $4.18J$  will produce same effect as transferring one calorie of  $DQ$ .

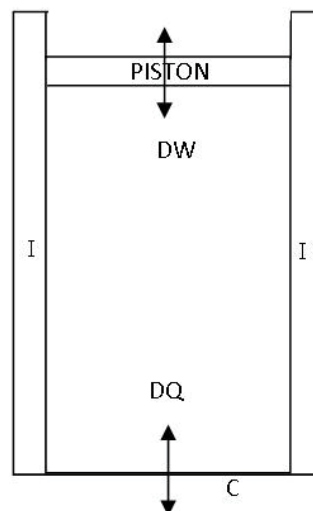

Next, consider a gas. If the piston moves by  $\Delta y$  work done is

$$\Delta W = F\Delta y = P A \Delta y = P \Delta V$$

For a finite change of volume

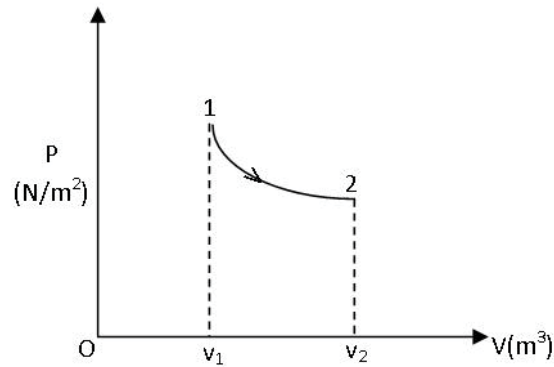

and the work done  $W_{1-2}$  is the area under the  $P$  vs.  $V$  curve.

Two facts stand out:

1. In the process 1–2 the work done depends on the path (thermodynamic)
2. Because work can be used to mimic  $DQ$ , the quantity of heat exchange also depends on the path

AND NOTE:  $DQ$  and  $DW$  both involve interaction of system with surrounding. [ $\Delta T$  for former, moving piston for latter]

The beauty is that the algebraic sum of  $DQ$  and  $DW$ , that is,

$$\pm DQ \pm DW$$

**Is INDEPENDENT OF THE PATH!**

Recall that whenever we have a change of energy independent of the path we can define a potential so now we define a thermodynamic potential called the internal energy  $U$

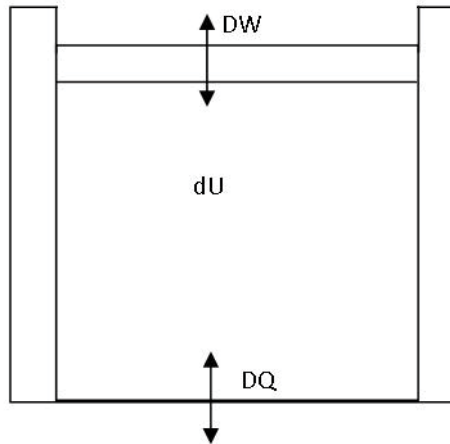

and this takes account of all the changes of energy in a thermodynamic process. The conservation law for energy then asserts that

$$\pm dU \pm DQ \pm DW \equiv 0$$

**Scholarships**

**Open your mind to new opportunities**

With 31,000 students, Linnaeus University is one of the larger universities in Sweden. We are a modern university, known for our strong international profile. Every year more than 1,600 international students from all over the world choose to enjoy the friendly atmosphere and active student life at Linnaeus University. Welcome to join us!

**Linnaeus University**  
Sweden

**Ln.u.se**

**Bachelor programmes in**  
*Business & Economics | Computer Science/IT | Design | Mathematics*

**Master programmes in**  
*Business & Economics | Behavioural Sciences | Computer Science/IT | Cultural Studies & Social Sciences | Design | Mathematics | Natural Sciences | Technology & Engineering*

**Summer Academy courses**



or equivalently

$$\boxed{dU = \pm DQ \pm DW}$$

Path Independent      Path Dependent

this is the formal statement of the first law of thermodynamics.

**N.B.**  $d \rightarrow$  Path independent change

$D \rightarrow$  Path dependent change

For solids/liquids  $DQ$ ,  $DW$  go to change  $dU = mc\Delta T$  or  $mL$ . For an ideal gas,  $U$  is a function of temperature only.

If gas is monatomic

$$U_{MA} = \frac{3}{2} Nk_B T \quad (\text{Proved in deriving pressure})$$

If gas is diatomic

$$U_{DA} = \frac{5}{2} Nk_B T \quad (\text{Good near 300K})$$

$$k_B = 1.383 \times 10^{-23} \text{ J / K}$$

$T$  is temperature in  $^{\circ}K$

# 27 First Law – Thermodynamic Processes

For simplicity we are going to assume that our system consists of a perfect gas. Quantity will be  $n$  mols so

$$PV = nRT$$

First law tells us that

$$DQ = dU + DW$$

and  $u$  is a function of  $T$  only.

$$\text{Monatomic gas} \quad U = \frac{3}{2}nRT \quad (\text{MA})$$

$$\text{Diatomic gas} \quad U = \frac{5}{2}nRT \quad [\text{near } 300\text{K}] \quad (\text{DA})$$

## I: Constant Volume [*ISOCHORE*]

Here  $DW = 0$

So

$$DQ = dU$$

$$= \frac{3}{2}nR\Delta T$$

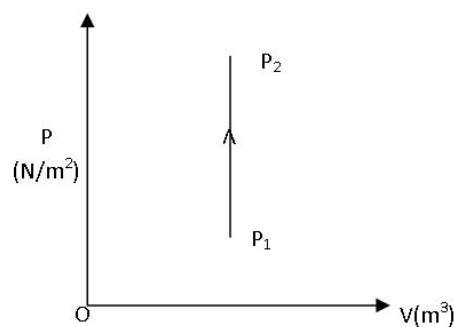

Specific Heat (Quantity of heat required to change temperature by 1°K)

$$C_v = \left( \frac{DQ}{\Delta T} \right)_v = \frac{3}{2} nR .$$

$$C_v \text{ per mol is } \frac{3}{2} R \quad (\text{MA})$$

$$\frac{5}{2} R \quad (\text{DA})$$

N.B. As V is const.  $\frac{P_2}{P_1} = \frac{T_2}{T_1}$

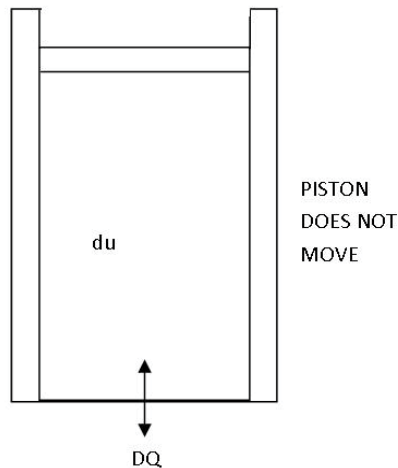

In the past four years we have drilled

# 89,000 km

That's more than **twice** around the world.

**Who are we?**  
We are the world's largest oilfield services company<sup>1</sup>. Working globally—often in remote and challenging locations—we invent, design, engineer, and apply technology to help our customers find and produce oil and gas safely.

**Who are we looking for?**  
Every year, we need thousands of graduates to begin dynamic careers in the following domains:

- Engineering, Research and Operations
- Geoscience and Petrotechnical
- Commercial and Business

**What will you be?**

<sup>1</sup>Based on Fortune 500 ranking 2011. Copyright © 2015 Schlumberger. All rights reserved.



II: Constant Pressure [ $P = \text{Const.}$ ]

$$DQ = dU + P \Delta V = \frac{3}{2} nR \Delta T + P \Delta V$$

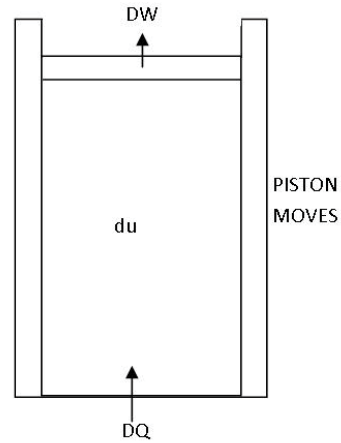
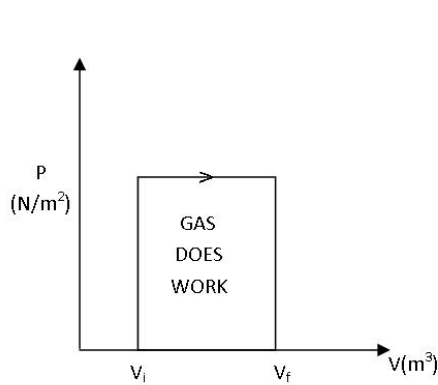

$$PV = nRT$$

$$(P + \Delta P)(V + \Delta V) = nR \Delta T$$

$$P \Delta V + V \Delta P = nR \Delta T \quad [\Delta P \Delta V \text{ negligible}]$$

$$\Delta P = 0, \quad P \Delta V = nR \Delta T$$

So  $DQ = \frac{3}{2} nR \Delta T + nR \Delta T$  (MA)

Specific heat

$$C_p = \left( \frac{DQ}{\Delta T} \right)_p = \frac{5}{2} nR$$

$$C_p \text{ per mol} = \left( \frac{5}{2} \right) R \quad (\text{MA}) \quad [C_p - C_v = R]$$

$$= \left( \frac{7}{2} \right) R \quad (\text{DA})$$

**NOTE:**  $C_p$  ALWAYS LARGER THAN  $C_v$ !

Define  $\gamma = \frac{C_p}{C_v}$ , always  $> 1$



**III: ISOTHERM. Temperature is const.**

$$P \propto \frac{1}{V}$$

$$dU = 0$$

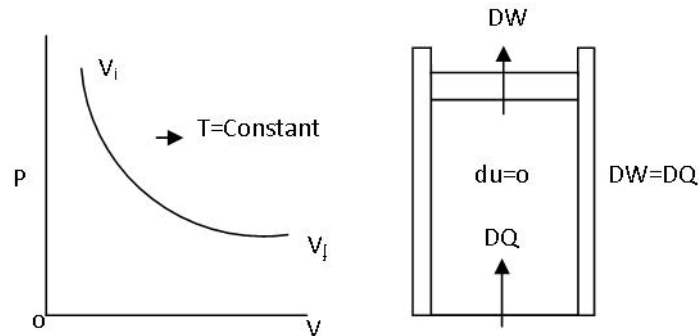

$P \propto \frac{1}{V}$  SO ISOTHERM MUST HAVE NEGATIVE SLOPE IN P vs V DIAGRAM.

$$DQ = \frac{3}{2} n R T \ln \left( V_f / V_i \right)$$

**IV: ADIABATIC [DQ = 0.]**

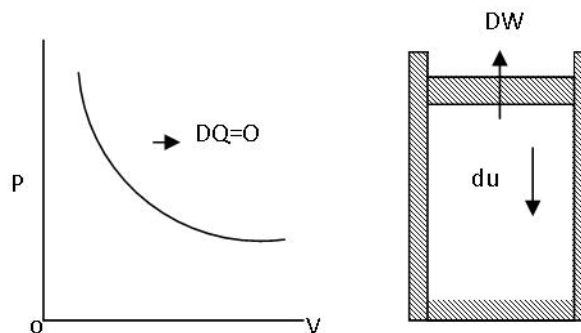

IF GAS EXPANDS IT MUST COOL DOWN BECAUSE DW COMES FROM dU

$$0 = dU + P \Delta V$$

Implies:

$$PV^\gamma = \text{Const.} \quad \gamma > 1$$

or

$$TV^{\gamma-1} = \text{Const.}$$

**N.B.**

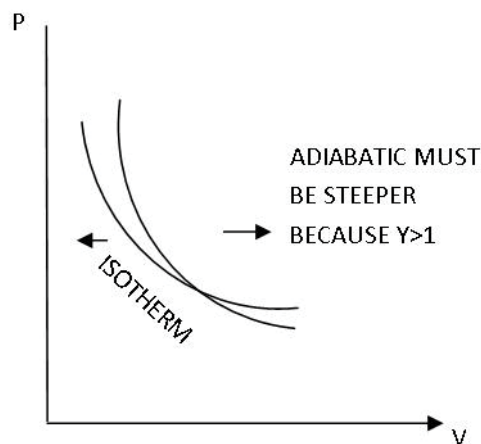

**V: Cyclic Process**

Since  $dU$  is independent of path

$$dU = 0$$

for a closed loop so

$$DQ = DW$$

For the cycle shown

A → B      Gas does work.

B → A      You do work.

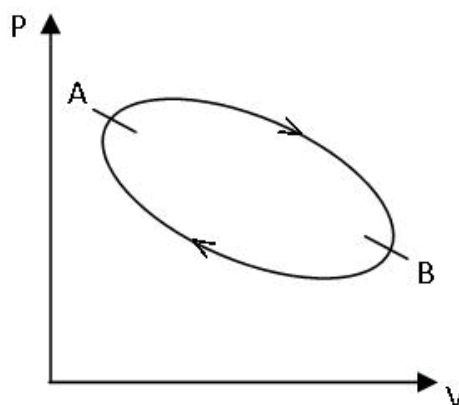

Gas does more work than you do so you must **ADD** heat into the system to carry out this cycle.

# 28 Thermodynamic Processes

When any one of the three parameters  $P$ ,  $V$  or  $T$  varies we claim that a thermodynamic process has occurred. We need to take a deeper look at the process.

We begin by recognizing that if you wish to represent the state of a system by a point (such as A) on a  $P$ - $V$  diagram, the system must be in equilibrium otherwise temperature is not the same everywhere and therefore  $P$  and  $V$  are not unique. This has the immediate implication that if you represent a thermodynamic process by a continuous line the system must be in equilibrium at every point along the way from initial state I to final state F.

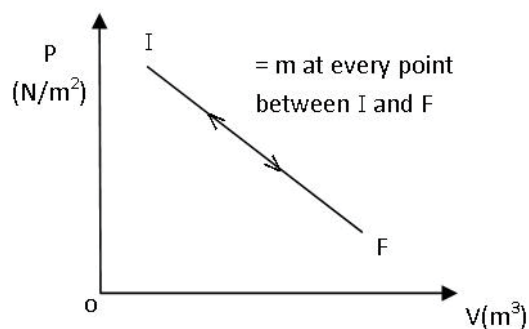
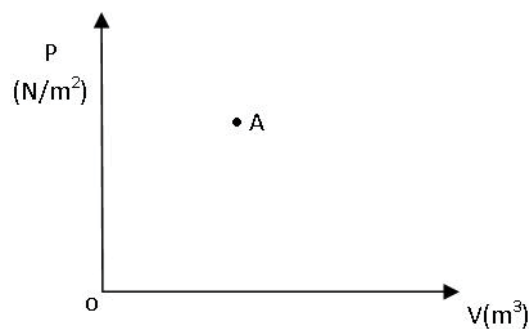

How can we do that? The process must be carried out infinitely slowly. For example, if  $I \rightarrow F$  is an adiabatic expansion you can imagine starting at  $I$ , reducing the pressure by removing one electron [mass =  $9 \times 10^{-31}$  kg] from the piston at a time and repeating this ever so small step to eventually reach  $F$ . Since the system is in  $\equiv m$  at every point, one can stop any where and go forward or back because each step is infinitesimal. Such a process is therefore REVERSIBLE. Hence the arrow is pointing both ways in diagram above. However, such a process will take forever, so it is only an IDEAL.

In a real process which must be carried out over small time intervals we ensure equilibrium only in the initial and final states. Hence, it is represented by two points on PV diagram.

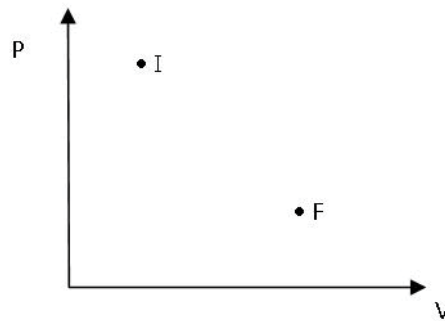

There is no information about any of the intermediate points. This is a REAL or LABORATORY process, but now we have no way of getting back to I so this process is IRREVERSIBLE.

## Trust and responsibility

NNE and Pharmaplan have joined forces to create NNE Pharmaplan, the world's leading engineering and consultancy company focused entirely on the pharma and biotech industries.

Inés Aréizaga Esteva (Spain), 25 years old  
Education: Chemical Engineer

– You have to be proactive and open-minded as a newcomer and make it clear to your colleagues what you are able to cope. The pharmaceutical field is new to me. But busy as they are, most of my colleagues find the time to teach me, and they also trust me. Even though it was a bit hard at first, I can feel over time that I am beginning to be taken seriously and that my contribution is appreciated.



NNE Pharmaplan is the world's leading engineering and consultancy company focused entirely on the pharma and biotech industries. We employ more than 1500 people worldwide and offer global reach and local knowledge along with our all-encompassing list of services.  
[nnepharmaplan.com](http://nnepharmaplan.com)

nne pharmaplan®



# 29 Second Law of Thermodynamics

**MOTIVATION:** By now we are fully aware that if two systems are at different temperatures and there is a conducting wall in between they will exchange heat  $DQ$  until equilibrium is attained. It is found that in this process the higher temperature reduces and the lower temperature rises [Recall minus sign in the equation  $\frac{DQ}{\Delta t} = -kA\frac{\Delta T}{\Delta x}$ ]. The question we need to answer is: why does exchange of heat invariably involve transfer from high  $T$  to low  $T$ , or, why will heat not “flow” spontaneously from low  $T$  to high  $T$ ? The Second Law of Thermodynamics was formulated to provide a succinct answer to this question. It will help to define a property which gives **DIRECTION** to a thermodynamic process.

The starting point comes as follows: we know that 4.18J of mechanical work will mimic the effects of 1 cal of Heat

$$4.18 \text{ J of DW} \Rightarrow 1 \text{ cal of DQ.}$$

and this can be done as often as we like using a cycle. At its simplest level the second law asserts that it is impossible to construct an engine which operates cyclically and whose only effect is to pick up heat  $DQ$  from a reservoir and deliver  $DW = DQ$ . That is, the following schema:

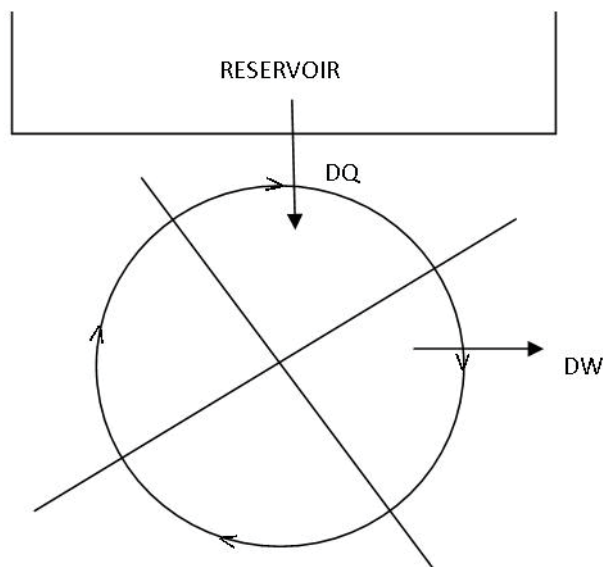

Is IMPOSSIBLE!!

So already you begin to discern a “Direction”  $4.18 \text{ J of DW} \Rightarrow 1 \text{ cal of DQ}$  but the Reverse cannot be done on a repeating basis.

So then, what is possible?

All existing engines produce useful work  $DW$  by picking up  $DQ_H$  but to do so they must reject  $DQ_C$  as shown below:

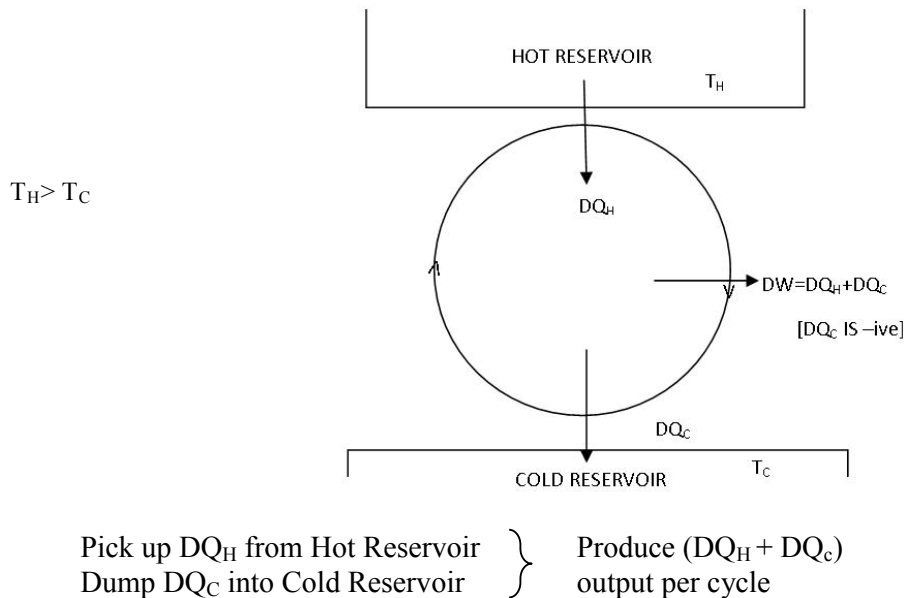

To fulfill the promise that the second law provides a basis for the direction of all thermodynamic processes we must use it to identify a **unidirectional** property. NOT SURPRISING THAT IT WILL BE CALLED ENTROPY [*FROM GREEK WORD εντροπομοψ*].

To do so we discuss a cyclic process proposed by Carnot-Carnot Cycle.

The working substance in our “engine” is going to be an ideal gas so that we can use the equations we wrote for thermodynamic processes.

The cycle is shown in PV-Diagram

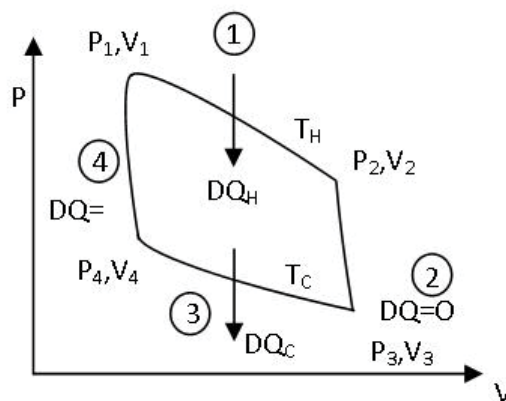

We start at  $P_1, V_1$  and carry out 4 processes:

- 1) **Isothermal Expansion** at  $T_H$ , we pick up  $DQ_H$  from hot reservoir.

$$dU = 0 \quad W = DQ_H = nRT_H \ln \frac{V_2}{V_1} \quad \rightarrow (1)$$

- 2) **Adiabatic Expansion** [ $TV^{\gamma-1} = Const$ ]. Gas is allowed to cool until temperature is  $T_C$ .

$$DQ = 0, \\ T_C V_3^{\gamma-1} = T_H V_2^{\gamma-1} \quad \rightarrow (2)$$

- 3) **Isothermal Contraction** at  $T_C$ . Discard  $DQ_C$  into Cold Reservoir

$$dU = 0 \quad DW = DQ_C = nRT_C \ln \frac{V_4}{V_3} \quad \rightarrow (3)$$

Note:  $DQ_C$  is a negative quantity.

This e-book  
is made with  
**SetaPDF**



**SETASIGN**

PDF components for PHP developers

[www.setasign.com](http://www.setasign.com)



Pt.  $P_4$ ,  $V_4$  is chosen judiciously so that we can carry out.

4) Adiabatic Contraction and Gas is allowed to warm up until temperature is back at  $T_H$ .

$$T_H V_4^{\gamma-1} = T_C V_4^{\gamma-1} \rightarrow (4)$$

Next, analyze Eqs. (1) through (4)

Combine (1) and (3)

$$\begin{aligned} \frac{DQ_H}{T_H} + \frac{DQ_C}{T_C} &= nR \left[ \ln \frac{V_2}{V_1} + \ln \frac{V_4}{V_3} \right] \\ &= nR \left[ \ln \frac{V_2 V_4}{V_1 V_3} \right] \\ &= nR \ln 1 \\ &= 0 \end{aligned}$$

Because from (2) and (4)

$$\frac{V_2}{V_3} = \left( \frac{T_C}{T_H} \right)^{\frac{1}{\gamma-1}} = \frac{V_1}{V_4}$$

That is,

$$\frac{DQ_H}{T_H} + \frac{DQ_C}{T_C} = 0 \rightarrow (A)$$

This has two very fundamental consequences:

I. Efficiency of our engine.

$$\eta = \frac{\text{Output}}{\text{Input}} = \frac{DQ_H + DQ_C}{DQ_H} = 1 - \frac{T_C}{T_H}$$

$\Rightarrow \eta$  is determined SOLELY by ratio of TEMPERATURES!

II. If we define a new property by the equation  $dS = \frac{DQ}{T}$

The change in S over a closed loop is ZERO!! S is unique. It is appropriate to use d. Change in S independent of Path.

S is called **ENTROPY**.

defines 
$$dS = \frac{DQ}{T} \quad (B)$$

change of Entropy in a **REVERSIBLE** PROCESS.

CARNOT CYCLE IN S-T DIAGRAM.



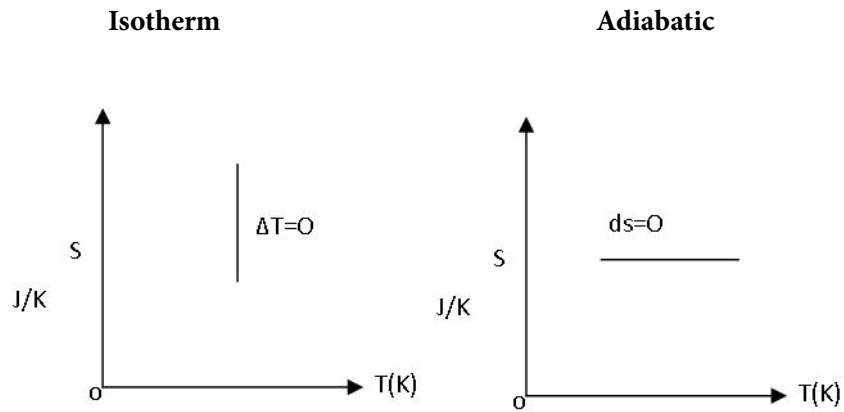

Cycle

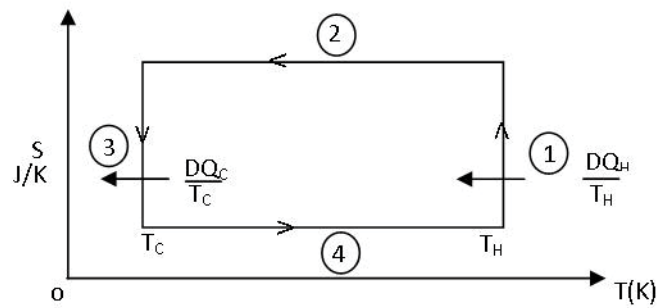

Is the Quantity defined in (B) unidirectional? The answer is yes. To prove it we proceed as follows:

Imagine that we carry out an IRREVERSIBLE ADIABATIC PROCESS –  $DQ = 0$ , but only initial and final state is in equilibrium so only they are represented on the P-V diagram.

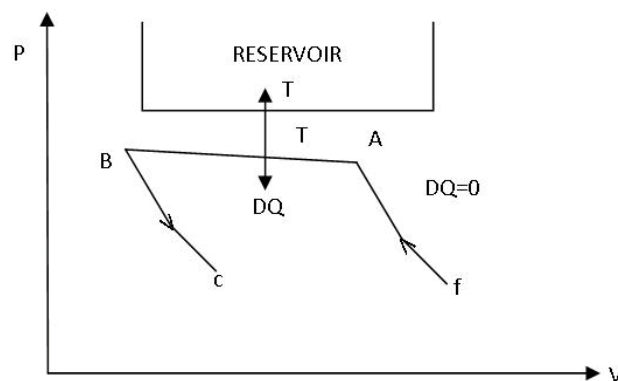

Since  $i$  and  $f$  are in equilibrium states, we can assign values  $S_i$  and  $S_f$  to them.

Next, carry out three **reversible** processes.

$f \rightarrow A$  reversible adiabatic,  $DQ = 0$  and by

$$\text{Eq.(B)} \quad dS = 0, \text{ so} \quad S_A = S_f$$

$A \rightarrow B$  reversible isotherm where system exchanges  $DQ$  with reservoir.

Choose  $B$  carefully so that

$B \rightarrow A$  reversible adiabatic  $[(DQ) = 0]$  takes us back to  $i$ . Again,  $\Delta S = 0$ , so  $S_B = S_i$ .

Altogether, we have an irreversible cycle  $i \rightarrow f \rightarrow A \rightarrow B \rightarrow i$  in which the only heat exchange is with the single reservoir at  $T$ . The second law forbids one taking  $DQ$  **from** the reservoir and converting it to  $DW$ .

It only allows us to discard  $DQ$  into the reservoir.

$$dS_{AB} = \frac{DQ}{T} = S_B - S_A < 0$$

so  $S_B < S_A$  and indeed  $S_f > S_i$

That is, in an irreversible adiabatic  $DQ = 0$ , but

$$dS > 0$$

"I studied English for 16 years but...  
...I finally learned to speak it in just six lessons"  
Jane, Chinese architect

ENGLISH OUT THERE

Click to hear me talking before and after my unique course download



So indeed change of  $S$  is unidirectional. In an adiabatic process  $S$  can only increase except in limiting case when process is reversible when  $dS = 0$ .

To summarize, in terms of entropy, 2<sup>nd</sup> law says:

$$dS \geq 0$$

in any adiabatic process.

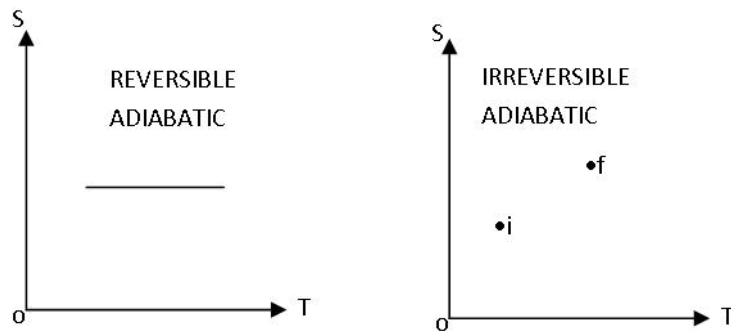

**NOTE:** FINAL STEP IN ARGUMENT IS THAT ANY PROCESS CAN BE RENDERED ADIABATIC BY PUTTING THE INSULATING BOUNDARY OUTSIDE ALL OF THE SYSTEMS INVOLVED IN THE PROCESS.

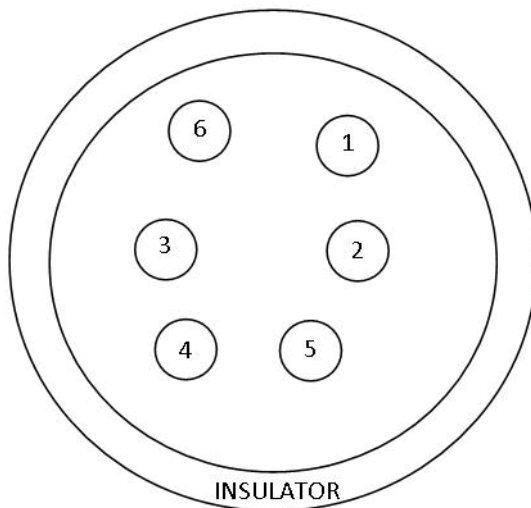

$$dS = \left( \sum dS_i \right) \geq 0$$

# 30 Formulae

Angle  $\Theta = \frac{S}{R}$

Trig. Functions  $\sin \Theta = \frac{o}{h}, \quad \cos \Theta = \frac{a}{h}, \quad \tan \Theta = \frac{o}{a}$

Pythagoras Theorem  $a^2 + o^2 = h^2; \quad \sin^2 \Theta + \cos^2 \Theta = 1$

Quadratic  $ax^2 + bx + c = 0, \quad x = \frac{-b \pm \sqrt{b^2 - 4ac}}{2a}$

Circle  $Area = \pi R^2$

Sphere  $Surface Area = 4\pi R^2 \quad volume = \frac{4\pi}{3} R^3$

Speed  $s = \frac{\text{Distance Travelled}}{\text{Time of Travel}}$

Unit Vectors  $\hat{x}, \hat{y}, \hat{z}$  Magnitude is 1 (one), directions along, x, y, z axis respectively

Displacement (on x-axis)  $\Delta \underline{x} = (x_f - x_i) \hat{x}$

Average Velocity  $\langle \underline{v} \rangle = \frac{(x_f - x_i)}{t_f - t_i} \hat{x}$

Instantaneous Velocity  $\underline{v} = \lim_{\Delta t \rightarrow 0} \left( \frac{\Delta \underline{x}}{\Delta t} \right)$

Average Acceleration  $\langle \underline{a} \rangle = \frac{v_f - v_i}{t_f - t_i}$

Instantaneous Acceleration  $\langle \underline{a} \rangle = \lim_{\Delta t \rightarrow 0} \left( \frac{\Delta \underline{v}}{\Delta t} \right)$

Kinematics

$$\begin{aligned} \text{Constant } \underline{v} &= v\hat{x}; & \underline{x} &= (x_i + vt)\hat{x} \\ \text{Constant } \underline{a} &= a\hat{x}; & \underline{v} &= (v_i + at)\hat{x} \\ \underline{x} &= \left(x_i + v_it + \frac{1}{2}at^2\right)\hat{x}; & v^2 &= v_i^2 + 2a(x - x_i) \end{aligned}$$

Free Fall

$$\begin{aligned} \underline{a} &= -9.8 \frac{m}{s^2} \hat{y} \\ \underline{v} &= (v_i - 9.8t)\hat{y} \\ \underline{y} &= (y_i + v_it - 4.9t^2)\hat{y} \\ v^2 &= v_i^2 - 19.6(y - y_i) \end{aligned}$$

Vector Algebra

$$\begin{aligned} \underline{R} &= \underline{A} + \underline{B} \\ R &= \sqrt{A^2 + B^2 + 2AB \cos \Theta} & [\Theta \text{ is angle between } \underline{A} \text{ and } \underline{B}] \\ \tan \Theta_R &= \frac{B \sin \Theta}{A + B \cos \Theta} \end{aligned}$$

Component of a Vector

$$\begin{aligned} v_d &= v \cos(\underline{v}, \hat{d}) \\ \text{In xy-plane} & \quad \underline{v} = v_x \hat{x} + v_y \hat{y} \\ v_x &= v \cos \Theta, \quad v_y = v \sin \Theta \\ \underline{R} &= \underline{v}_1 + \underline{v}_2 + \dots + \underline{v}_N = \Sigma \underline{v}_i = \Sigma v_{ix} \hat{x} + \Sigma v_{iy} \hat{y} \\ R_x &= \Sigma v_{ix}, \quad R_y = \Sigma v_{iy} \\ R &= \sqrt{R_x^2 + R_y^2} & \tan \Theta_R = \frac{R_y}{R_x} \end{aligned}$$

Trig. Identities

$$\begin{aligned} \sin(\Theta_1 + \Theta_2) &= (\sin \Theta_1 \cos \Theta_2 + \cos \Theta_1 \sin \Theta_2) \\ \cos(\Theta_1 + \Theta_2) &= (\cos \Theta_1 \cos \Theta_2 - \sin \Theta_1 \sin \Theta_2) \end{aligned}$$

Projectile Motion

$$\underline{a} = 0\hat{x} - 9.8 \frac{m}{s^2} \hat{y}$$

Initial Velocity  $\underline{v}_i = (v_i \cos \Theta_i) \hat{x} + (v_i \sin \Theta_i) \hat{y}$

Velocity  $v_x = v_i \cos \Theta_i$   $v_y = (v_i \sin \Theta_i - 9.8t)$

Position  $x = (v_i \cos \Theta_i)t$   $y = (v_i \sin \Theta_i)t - 4.9t^2$   
 $y_{top} = \frac{v_i^2 \sin^2 \Theta_i}{19.6}$   $t_{top} = \frac{v_i \sin \Theta_i}{9.8}$

Range  $R = \frac{v_i^2 \sin 2\Theta_i}{9.8}$

Equation of Parabolic Path  $y = y_i + x \tan \Theta_i - 4.9 \left( \frac{x}{v_i \cos \Theta_i} \right)^2$

Dynamics

Equilibrium  $\Sigma_i \underline{F}_i \equiv 0$

Non-Zero  $\underline{a}$   $M \underline{a} = \Sigma \underline{F}_i$  AT THAT POINT  
 AT THAT TIME  
 (Free Body Diagram!)

Forces Weight  $\underline{W} = -Mg \hat{y}$   
 Spring Force  $\underline{F}_{sp} = -k \Delta x \hat{x}$

Friction  $f_s \leq \mu_s n$  (Static)  
 $f_k = \mu_k n$  (Kinetic)

Circular Motion (Uniform in xy-plane)

Period =  $T$  seconds

Angular Velocity  $\underline{\omega} = \pm \frac{2\pi}{T} \hat{z}$  (Right hand rule)

Position  $\underline{r} = R \hat{r}$  Velocity  $\underline{v} = R \omega \hat{t} = \frac{2\pi R}{T} \hat{t}$

Centripetal Acceleration  $\underline{a}_c = -R \omega^2 \hat{r} = \frac{-v^2}{R} \hat{r}$

Centripetal Force (Required)  $\underline{F}_c = -MR\omega^2 \hat{r} = -\frac{Mv^2}{R} \hat{r}$

Gravitational Force

Two Point Masses  $\underline{F}_G = \frac{-GM_1M_2}{r^2}$

Point Mass and Shell  $r < R_{shell} \quad F_G = 0$   
 $r > R_{shell} \quad \underline{F}_G = \frac{-GM_{shell}m}{r^2} \hat{r}$

Point Mass and Uniform Sphere (Density  $d$ ) of Mass  $M$

$r < R \quad \underline{F}_G = \frac{-4\pi}{3} Gdmr\hat{r}$

$r > R \quad \underline{F}_G = \frac{-GMm}{r^2} \hat{r}$

Keplerian Orbits (Circular)

Planets  $T_p^2 = \frac{4\pi^2}{GM_{Sun}} R_p^3$

Earth Satellites  $T_s^2 = \frac{4\pi^2}{GM_{Earth}} R_s^3$

Conservation Laws

Mechanical Energy: Work  $\Delta W = \underline{F} \bullet \underline{\Delta S} = F\Delta S \cos(\underline{F}, \underline{\Delta S})$   
 $= F_{\parallel} \Delta S$

[Vector Algebra: Scalar Product  $\underline{A} \bullet \underline{B} = AB \cos(\underline{A}, \underline{B})$ ]

Kinetic Energy:  $K = \frac{1}{2} MV^2$

Change of Potential Energy:  $\Delta P = -\underline{F}_{co} \bullet \underline{\Delta S}$

$\underline{F}_{co}$ : Conservative Force (Work done independent of path, only end-points matter)

Earth-Mass  $P_g = Mgh$

Spring  $P_{sp} = \frac{1}{2} kx^2$

Conservation of Mechanical Energy

$$K_f + P_f = K_i + P_i + W_{NCF}$$

$W_{NCF}$  = Work done by Non-Conservative Force

Potential Energy for  $F_G$

Two Point Masses

$$P_G = \frac{-GM_1M_2}{r}$$

Point Mass and Shell

$$r > R_{Shell} \quad P_G = \frac{-GmM}{r}$$

$$r < R_{Shell} \quad P_G = \frac{-GmM}{R_{Shell}}$$

Point Mass and Uniform Sphere

$$r > R \quad P_G = \frac{-GmM}{r}$$

$$r < R \quad P_G = \frac{-GmM}{R} - \frac{GMm}{2R} \left[ 1 - \frac{r^2}{R^2} \right]$$

Linear Momentum

$$\underline{p} = m\underline{v};$$

Kinetic Energy

$$K = \frac{p^2}{2M}$$

$$\frac{\Delta p}{\Delta t} = \Sigma \underline{F}_i$$

$$\underline{J} = \langle \underline{F}_i \rangle \Delta t$$

Impulse

Conservation Law (Many Finite Objects)

$$\text{If } \underline{F}_{ext} = 0$$

$$\Sigma \underline{p}_i = \text{constant}$$

Two Body Collisions

$$\underline{p}_1' + \underline{p}_2' = \underline{p}_1 + \underline{p}_2 \quad \text{ALWAYS}$$

$$\underline{r}_{cm} = \frac{M_1 \underline{r}_1 + M_2 \underline{r}_2}{M_1 + M_2}, \underline{v}_{cm} = \text{constant}$$

Totally Elastic Collisions

$$\frac{1}{2} M_1 v_1^2 + \frac{1}{2} M_2 v_2^2 = \frac{1}{2} M_1 v_1'^2 + \frac{1}{2} M_2 v_2'^2$$

(Kinetic Energy also conserved)

Totally Inelastic Collisions

$$\underline{v}_1' = \underline{v}_2'$$

(Objects stick together)



Totally Elastic Head-On Collision

$$\underline{v}_1' = \left( \frac{M_1 - M_2}{M_1 + M_2} \right) \underline{v}_1 + \left( \frac{2M_2}{M_1 + M_2} \right) \underline{v}_2$$

$$\underline{v}_2' = \left( \frac{M_2 - M_1}{M_1 + M_2} \right) \underline{v}_2 + \left( \frac{2M_1}{M_1 + M_2} \right) \underline{v}_1$$

Non-Uniform Circular Motion (xy-plane)

Angular Acceleration  $\underline{\alpha} = \alpha \hat{z}$   
 Tangential Acceleration  $\underline{a}_t = R\alpha \hat{\tau}$   
 Angular Velocity  $\underline{\omega} = (\omega_i + \alpha t) \hat{z}$   
 Tangential Velocity  $\underline{v}_t = R\omega \hat{\tau}$   
 Angular "Position"  $\underline{\Theta} = \left( \Theta_i + \omega_i t + \frac{1}{2} \alpha t^2 \right) \hat{z}$

Displacement on Circle  $S = R\Theta$   
 $\omega^2 = \omega_i^2 + 2\alpha(\Theta - \Theta_i)$

Rigid Body Motions

$$\underline{r}_{CM} = \underline{r}_{C \cdot G} = \frac{\sum m_i \underline{r}_i}{\sum m_i} \quad \sum m_i = M$$

Translation  $\underline{y}$  is common  $M \underline{a} = \sum \underline{F}_i$   
 $\underline{a}$  is common

Rotation  $\underline{\alpha}$  is common  
 $\underline{\omega}$  is common  
 To cause  $\underline{\alpha}$  need Torque  $\underline{\tau} = [\underline{r} \times \underline{F}]$

Vector Algebra: Cross Product  $\underline{C} = [\underline{A} \times \underline{B}]$ ,  $C = AB \sin(\underline{A}, \underline{B})$ ,  $\underline{C} \perp \underline{A}$  and  $\underline{B}$   
 $\tau = rF \sin(\underline{r}, \underline{F}) = rF_{\perp} = r_{\perp} F$

Dynamics  $I \underline{\alpha} = \sum \underline{\tau}_i$

I: Moment of Inertia  $I = \sum m_i r_i^2$

Kinetic Energy

Translation  $K_{Tr} = \frac{1}{2} M v^2$

Rotation  $K_{Rot} = \frac{1}{2} I \omega^2$

Angular Momentum

Single Mass  $\underline{l} = [\underline{r} \times \underline{p}]$   $\underline{l} = mr^2\omega\hat{z}$   
 Rigid Body  $\underline{L} = I\omega$   
 Conservation Law: If  $\underline{\tau}_{Ext} = 0$ ,  $\underline{L} = \text{Constant}$

Thermodynamics

Pressure  $P = \frac{F}{A}$   
 Near Earth  $\Delta P = -dg\Delta y$   
 In Liquid at Depth  $P = P_A + dgh$   
 $P_A = 10^5 \frac{N}{m^2}$  (Atmospheric)

Temperature ( $\Theta$ ) NEEDED TO DEFINE EQUILIBRIUM

Scales  $\frac{C}{5} = \frac{F - 32}{9}$   $K = C + 273$

Ideal Gas  $PV = Nk_B T = \mu RT$   
 $k_B = 1.38 \times 10^{-23} \frac{J}{K}$ ,  $R = 8.36 J/mol/K$   
 $P = \frac{1}{3} m \frac{N}{V} \langle C^2 \rangle$ ;  $\langle \underline{C} \rangle = 0$   
 $\frac{1}{2} m \langle C^2 \rangle = \frac{3}{2} k_B T$   
 $C_{rms} = \sqrt{\langle C^2 \rangle} = \sqrt{\frac{3k_B T}{m}}$

Expansion:

Solids

Linear  $l = l_0 [1 + \alpha(\Theta - \Theta_i)]$   
 Volume  $V = V_0 [1 + 3\alpha(\Theta - \Theta_i)]$

Liquids

$V = V_0 [1 + \beta(\Theta - \Theta_i)]$

Heat

Solids/Liquids  $DQ = mC\Delta\Theta$  or  $mL$   
 Calorimetry  $\Sigma m_i C_i \Delta\Theta_i + \Sigma m_j L_j = 0$

Modes of Transfer

Conduction Solids/Immobile Liquids

Steady State  $\frac{DQ}{\Delta t} = -KA \frac{\Delta T}{\Delta x}$

Radiation  $\frac{DQ}{\Delta t} = Ae\sigma T^4$

$$\sigma = 6 \times 10^{-8} \text{ J/sec/m}^2/\text{K}^4$$

### Laws of Thermodynamics

#### First Law: Conservation of Energy

$$\pm DQ \pm DW \pm dU = 0$$

$U$  = Internal Energy

Monatomic Gas (per Mol)  $U_{MA} = \frac{3}{2} RT$

Diatomic Gas  $U_{DA} = \frac{5}{2} RT$

Specific Heats: Gas

Constant Volume  $(C_V)_{MA} = \frac{3}{2} R$ ,  $(C_V)_{DA} = \frac{5}{2} R$  (per Mol)

Constant Pressure  $C_P = (C_V + R)$

$$\gamma = \frac{C_P}{C_V} \quad (>1)$$

#### Processes

Isochoric  $(\Delta V = 0)$  Constant Volume  
 $DQ = dU$   $C_V = \left( \frac{dU}{\Delta T} \right)_V$

Isobaric  $(\Delta P = 0)$  Constant Pressure  
 $DQ = dU + P\Delta V$   $C_P = C_V + R$

Isothermic  $(\Delta T = 0)$  Constant Temperature  
 $dU = 0$   $DQ = DW = RT \ln \left( \frac{V_f}{V_i} \right)$

Adiabatic  $DQ = 0$   $PV^\gamma = \text{Constant}$   
 Or  
 $TV^{\gamma-1} = \text{Constant}$

Cyclic  $dU_{\text{Cycle}} = 0$   
 $DW_{\text{Cycle}} = (\text{Area of Loop in } P \text{ vs. } V \text{ Diagram})$

Second Law: Direction of Thermodynamic Processes (Entropy)

Carnot Cycle: (4 Reversible Processes)

$$\frac{DQ_H}{T_H} + \frac{DQ_C}{T_C} = 0$$

Change of Entropy in Reversible Process

$$dS = \frac{DQ}{T}$$

Efficiency     Engine      $\eta = \frac{DQ_H + DQ_C}{DQ_H} = 1 - \frac{T_C}{T_H}$

Heat Pump, Coefficient of Performance

$$COP = \frac{T_H}{T_H - T_C}$$

Change of Entropy in any adiabatic process  $dS \geq 0!$