

HANDBOOK OF DIFFERENTIAL EQUATIONS

*Ordinary Differential
Equations*

VOLUME 1

Edited by
A. Cañada
P. Drábek
A. Fonda

HANDBOOK
OF DIFFERENTIAL EQUATIONS
ORDINARY DIFFERENTIAL EQUATIONS
VOLUME I

This Page Intentionally Left Blank

HANDBOOK
OF DIFFERENTIAL EQUATIONS
ORDINARY DIFFERENTIAL
EQUATIONS
VOLUME I

Edited by

A. CAÑADA

*Department of Mathematical Analysis, Faculty of Sciences,
University of Granada, Granada, Spain*

P. DRÁBEK

*Department of Mathematics, Faculty of Applied Sciences,
University of West Bohemia, Pilsen, Czech Republic*

A. FONDA

*Department of Mathematical Sciences, Faculty of Sciences,
University of Trieste, Trieste, Italy*

2004



ELSEVIER
NORTH
HOLLAND

Amsterdam • Boston • Heidelberg • London • New York • Oxford •
Paris • San Diego • San Francisco • Singapore • Sydney • Tokyo

ELSEVIER B.V.
Sara Burgerhartstraat 25
P.O. Box 211, 1000 AE Amsterdam
The Netherlands

ELSEVIER Inc.
525 B Street, Suite 1900
San Diego, CA 92101-4495
USA

ELSEVIER Ltd
The Boulevard, Langford Lane
Kidlington, Oxford OX5 1GB
UK

ELSEVIER Ltd
84 Theobalds Road
London WC1X 8RR
UK

© 2004 Elsevier B.V. All rights reserved.

This work is protected under copyright by Elsevier B.V., and the following terms and conditions apply to its use:

Photocopying

Single photocopies of single chapters may be made for personal use as allowed by national copyright laws. Permission of the Publisher and payment of a fee is required for all other photocopying, including multiple or systematic copying, copying for advertising or promotional purposes, resale, and all forms of document delivery. Special rates are available for educational institutions that wish to make photocopies for non-profit educational classroom use.

Permissions may be sought directly from Elsevier's Rights Department in Oxford, UK: phone (+44) 1865 843830, fax (+44) 1865 853333, e-mail: permissions@elsevier.com. Requests may also be completed on-line via the Elsevier homepage (<http://www.elsevier.com/locate/permissions>).

In the USA, users may clear permissions and make payments through the Copyright Clearance Center, Inc., 222 Rosewood Drive, Danvers, MA 01923, USA; phone: (+1) (978) 7508400, fax: (+1) (978) 7504744, and in the UK through the Copyright Licensing Agency Rapid Clearance Service (CLARCS), 90 Tottenham Court Road, London W1P 0LP, UK; phone: (+44) 20 7631 5555, fax: (+44) 20 7631 5500. Other countries may have a local reprographic rights agency for payments.

Derivative Works

Tables of contents may be reproduced for internal circulation, but permission of the Publisher is required for external resale or distribution of such material. Permission of the Publisher is required for all other derivative works, including compilations and translations.

Electronic Storage or Usage

Permission of the Publisher is required to store or use electronically any material contained in this work, including any chapter or part of a chapter.

Except as outlined above, no part of this work may be reproduced, stored in a retrieval system or transmitted in any form or by any means, electronic, mechanical, photocopying, recording or otherwise, without prior written permission of the Publisher. Address permissions requests to: Elsevier's Rights Department, at the fax and e-mail addresses noted above.

Notice

No responsibility is assumed by the Publisher for any injury and/or damage to persons or property as a matter of products liability, negligence or otherwise, or from any use or operation of any methods, products, instructions or ideas contained in the material herein. Because of rapid advances in the medical sciences, in particular, independent verification of diagnoses and drug dosages should be made.

First edition 2004

Library of Congress Cataloging in Publication Data: A catalog record is available from the Library of Congress.

British Library Cataloguing in Publication Data:

Handbook of differential equations

Ordinary differential equations: Vol. 1

I. Differential equations

I. Cañada, A. II. Drábek, P. III. Fonda, A.

515.3'5

ISBN 0444511288

ISBN: 0-444-51128-8 (volume 1)

0-444-51742-1 (set)

⊗ The paper used in this publication meets the requirements of ANSI/NISO Z39.48-1992 (Permanence of Paper).
Printed in The Netherlands.

Working together to grow
libraries in developing countries

www.elsevier.com | www.bookaid.org | www.sabre.org

ELSEVIER

BOOK AID
International

Sabre Foundation

Preface

Ordinary differential equations is a wide mathematical discipline which is closely related to both pure mathematical research and real world applications. Most mathematical formulations of physical laws are described in terms of ordinary and partial differential equations, and this has been a great motivation for their study in the past. In the 20th century the extremely fast development of Science led to applications in the fields of chemistry, biology, medicine, population dynamics, genetic engineering, economy, social sciences and others, as well. All these disciplines promoted to higher level and new discoveries were made with the help of this kind of mathematical modeling. At the same time, real world problems have been and continue to be a great inspiration for pure mathematics, particularly concerning ordinary differential equations: they led to new mathematical models and challenged mathematicians to look for new methods to solve them.

It should also be mentioned that an extremely fast development of computer sciences took place in the last three decades: mathematicians have been provided with a tool which had not been available before. This fact encouraged scientists to formulate more complex mathematical models which, in the past, could hardly be resolved or even understood. Even if computers rarely permit a rigorous treatment of a problem, they are a very useful tool to get concrete numerical results or to make interesting numerical experiments. In the field of ordinary differential equations this phenomenon led more and more mathematicians to the study of nonlinear differential equations. This fact is reflected pretty well by the contributions to this volume.

The aim of the editors was to collect survey papers in the theory of ordinary differential equations showing the “state of the art”, presenting some of the main results and methods to solve various types of problems. The contributors, besides being widely acknowledged experts in the subject, are known for their ability of clearly divulging their subject. We are convinced that papers like the ones in this volume are very useful, both for the experts and particularly for younger research fellows or beginners in the subject. The editors would like to express their deepest gratitude to all contributors to this volume for the effort made in this direction.

The contributions to this volume are presented in alphabetical order according to the name of the first author. The paper by Agarwal and O’Regan deals with singular initial and boundary value problems (the nonlinear term may be singular in its dependent variable and is allowed to change sign). Some old and new existence results are established and the proofs are based on fixed point theorems, in particular, Schauder’s fixed point theorem and a Leray–Schauder alternative. The paper by De Coster and Habets is dedicated to the method of upper and lower solutions for boundary value problems. The second order equations with various kinds of boundary conditions are considered. The emphasis is put

on well ordered and non-well ordered pairs of upper and lower solutions, connection to the topological degree and multiplicity of the solutions. The contribution of Došlý deals with half-linear equations of the second order. The principal part of these equations is represented by the one-dimensional p -Laplacian and the author concentrates mainly on the oscillatory theory. The paper by Jacobsen and Schmitt is devoted to the study of radial solutions for quasilinear elliptic differential equations. The p -Laplacian serves again as a prototype of the main part in the equation and the domains as a ball, an annular region, the exterior of a ball, or the entire space are under investigation. The paper by Llibre is dedicated to differential systems or vector fields defined on the real or complex plane. The author presents a deep and complete study of the existence of first integrals for planar polynomial vector fields through the Darbouxian theory of integrability. The paper by Mawhin takes the simple forced pendulum equation as a model for describing a variety of nonlinear phenomena: multiplicity of periodic solutions, subharmonics, almost periodic solutions, stability, boundedness, Mather sets, KAM theory and chaotic dynamics. It is a review paper taking into account more than a hundred research articles appeared on this subject. The paper by Szrednicki is a review of the main results obtained by the Ważewski method in the theory of ordinary differential equations and inclusions, and retarded functional differential equations, with some applications to boundary value problems and detection of chaotic dynamics. It is concluded by an introduction of the Conley index with examples of possible applications.

Last, but not least, we thank the Editors at Elsevier, who gave us the opportunity of making available a collection of articles that we hope will be useful to mathematicians and scientists interested in the recent results and methods in the theory and applications of ordinary differential equations.

List of Contributors

- Agarwal, R.P., *Florida Institute of Technology, Melbourne, FL* (Ch. 1)
De Coster, C., *Université du Littoral, Calais Cédex, France* (Ch. 2)
Došlý, O., *Masaryk University, Brno, Czech Republic* (Ch. 3)
Habets, P., *Université Catholique de Louvain, Louvain-la-Neuve, Belgium* (Ch. 2)
Jacobsen, J., *Harvey Mudd College, Claremont, CA* (Ch. 4)
Llibre, J., *Universitat Autònoma de Barcelona, Bellaterra, Barcelona, Spain* (Ch. 5)
Mawhin, J., *Université Catholique de Louvain, Louvain-la-Neuve, Belgium* (Ch. 6)
O'Regan, D., *National University of Ireland, Galway, Ireland* (Ch. 1)
Schmitt, K., *University of Utah, Salt Lake City, UT* (Ch. 4)
Szrednicki, R., *Institute of Mathematics, Jagiellonian University, Kraków, Poland* (Ch. 7)

This Page Intentionally Left Blank

Contents

<i>Preface</i>	v
<i>List of Contributors</i>	vii
1. A survey of recent results for initial and boundary value problems singular in the dependent variable <i>R.P. Agarwal and D. O'Regan</i>	1
2. The lower and upper solutions method for boundary value problems <i>C. De Coster and P. Habets</i>	69
3. Half-linear differential equations <i>O. Došlý</i>	161
4. Radial solutions of quasilinear elliptic differential equations <i>J. Jacobsen and K. Schmitt</i>	359
5. Integrability of polynomial differential systems <i>J. Llibre</i>	437
6. Global results for the forced pendulum equation <i>J. Mawhin</i>	533
7. Ważewski method and Conley index <i>R. Srzednicki</i>	591
Author Index	685
Subject Index	693

This Page Intentionally Left Blank

CHAPTER 1

A Survey of Recent Results for Initial and Boundary Value Problems Singular in the Dependent Variable

Ravi P. Agarwal

*Department of Mathematics, Florida Institute of Technology, Melbourne, FL 32901, USA
E-mail: agarwal@fit.edu*

Donal O'Regan

*Department of Mathematics, National University of Ireland, Galway, Ireland
E-mail: donal.oregan@nuigalway.ie*

Contents

1. Introduction	3
2. Singular boundary value problems	8
2.1. Positone problems	8
2.2. Singular problems with sign changing nonlinearities	22
3. Singular initial value problems	51
References	67

Abstract

In this survey paper we present old and new existence results for singular initial and boundary value problems. Our nonlinearity may be singular in its dependent variable and is allowed to change sign.

This Page Intentionally Left Blank

1. Introduction

The study of singular boundary value problems (singular in the dependent variable) is relatively new. Indeed it was only in the middle 1970s that researchers realized that large numbers of applications [7,11,12] in the study of nonlinear phenomena gave rise to singular boundary value problems (singular in the dependent variable). However, in our opinion, it was the 1979 paper of Taliaferro [20] that generated the interest of many researchers in singular problems in the 1980s and 1990s. In [20] Taliaferro showed that the singular boundary value problem

$$\begin{cases} y'' + q(t)y^{-\alpha} = 0, & 0 < t < 1, \\ y(0) = 0 = y(1), \end{cases} \quad (1.1)$$

has a $C[0, 1] \cap C^1(0, 1)$ solution; here $\alpha > 0$, $q \in C(0, 1)$ with $q > 0$ on $(0, 1)$ and $\int_0^1 t(1-t)q(t) dt < \infty$. Problems of the form (1.1) arise frequently in the study of nonlinear phenomena, for example in non-Newtonian fluid theory, such as the transport of coal slurries down conveyor belts [12], and boundary layer theory [11]. It is worth remarking here that we could consider Sturm–Liouville boundary data in (1.1); however since the arguments are essentially the same (in fact easier) we will restrict our discussion to Dirichlet boundary data.

In the 1980s and 1990s many papers were devoted to singular boundary value problems of the form

$$\begin{cases} y'' + q(t)f(t, y) = 0, & 0 < t < 1, \\ y(0) = 0 = y(1), \end{cases} \quad (1.2)$$

and singular initial value problems of the form

$$\begin{cases} y' = q(t)f(t, y), & 0 < t < T(< \infty), \\ y(0) = 0. \end{cases} \quad (1.3)$$

Almost all singular problems in the literature [8–10,14–18,21] up to 1994 discussed positone problems, i.e., problems where $f : [0, 1] \times (0, \infty) \rightarrow (0, \infty)$. In Section 2.1 we present the most general results available in the literature for the positone singular problem (1.2). In 1999 the question of multiplicity for positone singular problems was discussed for the first time by Agarwal and O'Regan [2]. The second half of Section 2.1 discusses multiplicity. In 1994 [16] the singular boundary value problem (1.2) was discussed when the nonlinearity f could change sign. Model examples are

$$f(t, y) = t^{-1}e^{\frac{1}{y}} - (1-t)^{-1} \quad \text{and} \quad f(t, y) = \frac{g(t)}{y^\sigma} - h(t), \quad \sigma > 0$$

which correspond to Emden–Fowler equations; here $g(t) > 0$ for $t \in (0, 1)$ and $h(t)$ may change sign. Section 2.2 is devoted to (1.2) when the nonlinearity f may change sign. The results here are based on arguments and ideas of Agarwal, O'Regan et al. [1–6], and Habets

and Zanolin [16]. Section 3 presents existence results for the singular initial value problem (1.3) where the nonlinearity f may change sign.

The existence results in this paper are based on fixed point theorems. In particular we use frequently Schauder's fixed point theorem and a Leray–Schauder alternative. We begin of course with the Schauder theorem.

THEOREM 1.1. *Let C be a convex subset of a Banach space and $F : C \rightarrow C$ a compact, continuous map. Then F has a fixed point in C .*

In applications to construct a set C so that F takes C back into C is very difficult and sometimes impossible. As a result it makes sense to discuss maps F that map a subset of C into C . One result in this direction is the so-called nonlinear alternative of Leray–Schauder.

THEOREM 1.2. *Let E be a Banach space, C a convex subset of E , U an open subset of C and $0 \in U$. Suppose $F : \overline{U} \rightarrow C$ (here \overline{U} denotes the closure of U in C) is a continuous, compact map. Then either*

(A1) *F has a fixed point in \overline{U} ; or*

(A2) *there exists $u \in \partial U$ (the boundary of U in C) and $\lambda \in (0, 1)$ with $u = \lambda F(u)$.*

PROOF. Suppose (A2) does not occur and F has no fixed points in ∂U (otherwise we are finished). Let

$$A = \{x \in \overline{U} : x = tF(x) \text{ for some } t \in [0, 1]\}.$$

Now $A \neq \emptyset$ since $0 \in A$ and A is closed since F is continuous. Also notice $A \cap \partial U = \emptyset$. Thus there exists a continuous function $\mu : \overline{U} \rightarrow [0, 1]$ with $\mu(A) = 1$ and $\mu(\partial U) = 0$. Let

$$N(x) = \begin{cases} \mu(x)F(x), & x \in \overline{U}, \\ 0, & x \in C \setminus \overline{U}. \end{cases}$$

Clearly $N : C \rightarrow C$ is a continuous, compact map. Theorem 1.1 guarantees the existence of an $x \in C$ with $x = Nx$. Notice $x \in U$ since $0 \in U$. As a result $x = \mu(x)F(x)$, so $x \in A$. Thus $\mu(x) = 1$ and so $x = F(x)$. \square

To conclude the introduction we present existence principles for nonsingular initial and boundary value problems which will be needed in Sections 2 and 3. First we use Schauder's fixed point theorem and a nonlinear alternative of Leray–Schauder type to obtain a general existence principle for the Dirichlet boundary value problem

$$\begin{cases} y'' + f(t, y) = 0, & 0 < t < 1, \\ y(0) = a, \quad y(1) = b. \end{cases} \quad (1.4)$$

Throughout this paper $AC[0, 1]$ denotes the space of absolutely continuous functions on $[0, 1]$, $AC_{\text{loc}}(0, 1)$ the space of functions absolutely continuous on each compact subinterval of $(0, 1)$ and $L^1_{\text{loc}}(0, 1)$ the space of functions which are L^1 integrable on each compact subinterval of $(0, 1)$.

THEOREM 1.3. Suppose the following two conditions are satisfied:

$$\text{the map } y \mapsto f(t, y) \text{ is continuous for a.e. } t \in [0, 1] \quad (1.5)$$

and

$$\text{the map } t \mapsto f(t, y) \text{ is measurable for all } y \in \mathbf{R}. \quad (1.6)$$

(I) Assume

$$\left\{ \begin{array}{l} \text{for each } r > 0 \text{ there exists } h_r \in L^1_{\text{loc}}(0, 1) \text{ with} \\ \int_0^1 t(1-t)h_r(t) dt < \infty \text{ such that } |y| \leq r \text{ implies} \\ |f(t, y)| \leq h_r(t) \text{ for a.e. } t \in (0, 1) \end{array} \right. \quad (1.7)$$

holds. In addition suppose there is a constant $M > |a| + |b|$, independent of λ , with $|y|_0 = \sup_{t \in [0, 1]} |y(t)| \neq M$ for any solution $y \in AC[0, 1]$ (with $y' \in AC_{\text{loc}}(0, 1)$) to

$$\left\{ \begin{array}{l} y'' + \lambda f(t, y) = 0, \quad 0 < t < 1, \\ y(0) = a, \quad y(1) = b, \end{array} \right. \quad (1.8)_\lambda$$

for each $\lambda \in (0, 1)$. Then (1.4) has a solution y with $|y|_0 \leq M$.

(II) Assume

$$\left\{ \begin{array}{l} \text{there exists } h \in L^1_{\text{loc}}(0, 1) \text{ with } \int_0^1 t(1-t)h_r(t) dt < \infty \\ \text{such that } |f(t, y)| \leq h(t) \text{ for a.e. } t \in (0, 1) \text{ and } y \in \mathbf{R} \end{array} \right. \quad (1.9)$$

holds. Then (1.4) has a solution.

PROOF. (I) We begin by showing that solving $(1.8)_\lambda$ is equivalent to finding a solution $y \in C[0, 1]$ to

$$\begin{aligned} y(t) = & a(1-t) + bt + \lambda(1-t) \int_0^t s f(s, y(s)) ds \\ & + \lambda t \int_t^1 (1-s) f(s, y(s)) ds. \end{aligned} \quad (1.10)_\lambda$$

To see this notice if $y \in C[0, 1]$ satisfies $(1.10)_\lambda$ then it is easy to see (since (1.7) holds) that $y' \in L^1[0, 1]$. Thus $y \in AC[0, 1]$, $y' \in AC_{\text{loc}}(0, 1)$ and note

$$y'(t) = -a + b - \lambda \int_0^t s f(s, y(s)) ds + \lambda \int_t^1 (1-s) f(s, y(s)) ds.$$

Next integrate $y'(t)$ from 0 to x ($x \in (0, 1)$) and interchange the order of integration to get

$$y(x) - y(0) = \int_0^x y'(t) dt$$

$$\begin{aligned}
&= -ax + bx - \lambda \int_0^x \int_0^t sf(s, y(s)) \, ds \, dt \\
&\quad + \lambda \int_0^x \int_t^1 (1-s)f(s, y(s)) \, ds \, dt \\
&= -ax + bx + \lambda(1-x) \int_0^x sf(s, y(s)) \, ds \\
&\quad + \lambda x \int_x^1 (1-s)f(s, y(s)) \, ds \\
&= -a + y(x),
\end{aligned}$$

so $y(0) = a$. Similarly integrate $y'(t)$ from x ($x \in (0, 1)$) to 1 and interchange the order of integration to get $y(1) = b$. Thus if $y \in C[0, 1]$ satisfies (1.10) $_\lambda$ then y is a solution of (1.8) $_\lambda$.

Define the operator $N : C[0, 1] \rightarrow C[0, 1]$ by

$$\begin{aligned}
Ny(t) &= a(1-t) + bt + (1-t) \int_0^t sf(s, y(s)) \, ds \\
&\quad + t \int_t^1 (1-s)f(s, y(s)) \, ds.
\end{aligned} \tag{1.11}$$

Then (1.10) $_\lambda$ is equivalent to the fixed point problem

$$y = (1-\lambda)p + \lambda Ny, \quad \text{where } p = a(1-t) + b. \tag{1.12}_\lambda$$

It is easy to see that $N : C[0, 1] \rightarrow C[0, 1]$ is continuous and completely continuous. Set

$$U = \{u \in C[0, 1]: |u|_0 < M\}, \quad K = E = C[0, 1].$$

Now the nonlinear alternative of Leray–Schauder type guarantees that N has a fixed point, i.e., (1.10) $_1$ has a solution.

(II) Solving (1.4) is equivalent to the fixed point problem $y = Ny$ where N is as in (1.11). It is easy to see that $N : C[0, 1] \rightarrow C[0, 1]$ is continuous and compact (since (1.9) holds). The result follows from Schauder's fixed point theorem. \square

Finally we obtain a general existence principle for the initial value problem

$$\begin{cases} y' = f(t, y), & 0 < t < T (< \infty), \\ y(0) = a. \end{cases} \tag{1.13}$$

THEOREM 1.4. *Suppose the following two conditions are satisfied:*

$$\text{the map } y \mapsto f(t, y) \text{ is continuous for a.e. } t \in [0, T] \tag{1.14}$$

and

the map $t \mapsto f(t, y)$ is measurable for all $y \in \mathbf{R}$. (1.15)

(I) Assume

$\left\{ \begin{array}{l} \text{for each } r > 0 \text{ there exists } h_r \in L^1[0, T] \text{ such that} \\ |y| \leq r \text{ implies } |f(t, y)| \leq h_r(t) \text{ for a.e. } t \in (0, T) \end{array} \right.$ (1.16)

holds. In addition suppose there is a constant $M > |a|$, independent of λ , with $|y|_0 = \sup_{t \in [0, T]} |y(t)| \neq M$ for any solution $y \in AC[0, T]$ to

$\left\{ \begin{array}{l} y' = \lambda f(t, y), \quad 0 < t < T (< \infty), \\ y(0) = a, \end{array} \right.$ (1.17) $_{\lambda}$

for each $\lambda \in (0, 1)$. Then (1.13) has a solution y with $|y|_0 \leq M$.

(II) Assume

$\left\{ \begin{array}{l} \text{there exists } h \in L^1[0, T] \text{ such that } |f(t, y)| \leq h(t) \\ \text{for a.e. } t \in (0, T) \text{ and } y \in \mathbf{R} \end{array} \right.$ (1.18)

holds. Then (1.13) has a solution.

PROOF. (I) Solving (1.17) $_{\lambda}$ is equivalent to finding a solution $y \in C[0, T]$ to

$y(t) = a + \lambda \int_0^t f(s, y(s)) \, ds.$ (1.19) $_{\lambda}$

Define an operator $N : C[0, T] \rightarrow C[0, T]$ by

$Ny(t) = a + \int_0^t f(s, y(s)) \, ds.$ (1.20)

Then (1.19) $_{\lambda}$ is equivalent to the fixed point problem

$y = (1 - \lambda)a + \lambda Ny.$ (1.21) $_{\lambda}$

It is easy to see that $N : C[0, T] \rightarrow C[0, T]$ is continuous and completely continuous. Set

$U = \{u \in C[0, T]: |u|_0 < M\}, \quad K = E = C[0, T].$

Now the nonlinear alternative of Leray–Schauder type guarantees that N has a fixed point, i.e., (1.19) $_1$ has a solution.

(II) Solving (1.13) is equivalent to the fixed point problem $y = Ny$ where N is as in (1.20). It is easy to see that $N : C[0, T] \rightarrow C[0, T]$ is continuous and compact (since (1.18) holds). The result follows from Schauder's fixed point theorem. \square

2. Singular boundary value problems

In Section 2.1 we discuss positone boundary value problems. Almost all singular papers in the 1980s and 1990s were devoted to such problems. In Theorem 2.1 we present probably the most general existence result available in the literature for positone problems. In the late 1990s the question of multiplicity for singular positone problems was raised, and we discuss this question in the second half of Section 2.1. Section 2.2 is devoted to singular problems where the nonlinearity may change sign.

2.1. Positone problems

In this section we discuss the Dirichlet boundary value problem

$$\begin{cases} y'' + q(t)f(t, y) = 0, & 0 < t < 1, \\ y(0) = 0 = y(1). \end{cases} \quad (2.1)$$

Here the nonlinearity f may be singular at $y = 0$ and q may be singular at $t = 0$ and/or $t = 1$. We begin by showing that (2.1) has a $C[0, 1] \cap C^2(0, 1)$ solution. To do so we first establish, via Theorem 1.3, the existence of a $C[0, 1] \cap C^2(0, 1)$ solution, for each $m = 1, 2, \dots$, to the “modified” problem

$$\begin{cases} y'' + q(t)f(t, y) = 0, & 0 < t < 1, \\ y(0) = \frac{1}{m} = y(1). \end{cases} \quad (2.2)^m$$

To show that (2.1) has a solution we let $m \rightarrow \infty$; the key idea in this step is the Arzela–Ascoli theorem.

THEOREM 2.1. *Suppose the following conditions are satisfied:*

$$q \in C(0, 1), \quad q > 0 \quad \text{on } (0, 1) \quad \text{and} \quad \int_0^1 t(1-t)q(t) \, dt < \infty, \quad (2.3)$$

$$f : [0, 1] \times (0, \infty) \rightarrow (0, \infty) \text{ is continuous.} \quad (2.4)$$

$$\begin{cases} 0 \leq f(t, y) \leq g(y) + h(y) \text{ on } [0, 1] \times (0, \infty) \text{ with} \\ g > 0 \text{ continuous and nonincreasing on } (0, \infty), \\ h \geq 0 \text{ continuous on } [0, \infty), \text{ and } \frac{h}{g} \\ \text{nondecreasing on } (0, \infty), \end{cases} \quad (2.5)$$

$$\begin{cases} \text{for each constant } H > 0 \text{ there exists a function } \psi_H \\ \text{continuous on } [0, 1] \text{ and positive on } (0, 1) \text{ such that} \\ f(t, u) \geq \psi_H(t) \text{ on } (0, 1) \times (0, H] \end{cases} \quad (2.6)$$

and

$$\exists r > 0 \quad \text{with} \quad \frac{1}{\left\{1 + \frac{h(r)}{g(r)}\right\}} \int_0^r \frac{du}{g(u)} > b_0 \quad (2.7)$$

hold; here

$$b_0 = \max \left\{ 2 \int_0^{\frac{1}{2}} t(1-t)q(t) dt, 2 \int_{\frac{1}{2}}^1 t(1-t)q(t) dt \right\}. \quad (2.8)$$

Then (2.1) has a solution $y \in C[0, 1] \cap C^2(0, 1)$ with $y > 0$ on $(0, 1)$ and $|y|_0 < r$.

PROOF. Choose $\varepsilon > 0$, $\varepsilon < r$, with

$$\frac{1}{\{1 + \frac{h(r)}{g(r)}\}} \int_{\varepsilon}^r \frac{du}{g(u)} > b_0. \quad (2.9)$$

Let $n_0 \in \{1, 2, \dots\}$ be chosen so that $\frac{1}{n_0} < \varepsilon$ and let $N_0 = \{n_0, n_0 + 1, \dots\}$. To show (2.2)^m, $m \in N_0$, has a solution we examine

$$\begin{cases} y'' + q(t)F(t, y) = 0, & 0 < t < 1, \\ y(0) = y(1) = \frac{1}{m}, & m \in N_0, \end{cases} \quad (2.10)^m$$

where

$$F(t, u) = \begin{cases} f(t, u), & u \geq \frac{1}{m}, \\ f(t, \frac{1}{m}), & u \leq \frac{1}{m}. \end{cases}$$

To show (2.10)^m has a solution for each $m \in N_0$ we will apply Theorem 1.3. Consider the family of problems

$$\begin{cases} y'' + \lambda q(t)F(t, y) = 0, & 0 < t < 1, \\ y(0) = y(1) = \frac{1}{m}, & m \in N_0, \end{cases} \quad (2.11)^m_{\lambda}$$

where $0 < \lambda < 1$. Let y be a solution of (2.11)^m_λ. Then $y'' \leq 0$ on $(0, 1)$ and $y \geq \frac{1}{m}$ on $[0, 1]$. Also there exists $t_m \in (0, 1)$ with $y' \geq 0$ on $(0, t_m)$ and $y' \leq 0$ on $(t_m, 1)$. For $x \in (0, 1)$ we have

$$-y''(x) \leq g(y(x)) \left\{ 1 + \frac{h(y(x))}{g(y(x))} \right\} q(x). \quad (2.12)$$

Integrate from t ($t \leq t_m$) to t_m to obtain

$$y'(t) \leq g(y(t)) \left\{ 1 + \frac{h(y(t_m))}{g(y(t_m))} \right\} \int_t^{t_m} q(x) dx$$

and then integrate from 0 to t_m to obtain

$$\int_{\frac{1}{m}}^{y(t_m)} \frac{du}{g(u)} \leq \left\{ 1 + \frac{h(y(t_m))}{g(y(t_m))} \right\} \int_0^{t_m} xq(x) dx.$$

Consequently

$$\int_{\varepsilon}^{y(t_m)} \frac{du}{g(u)} \leq \left\{ 1 + \frac{h(y(t_m))}{g(y(t_m))} \right\} \int_0^{t_m} xq(x) dx$$

and so

$$\int_{\varepsilon}^{y(t_m)} \frac{du}{g(u)} \leq \left\{ 1 + \frac{h(y(t_m))}{g(y(t_m))} \right\} \frac{1}{1-t_m} \int_0^{t_m} x(1-x)q(x) dx. \quad (2.13)$$

Similarly if we integrate (2.12) from t_m to t ($t \geq t_m$) and then from t_m to 1 we obtain

$$\int_{\varepsilon}^{y(t_m)} \frac{du}{g(u)} \leq \left\{ 1 + \frac{h(y(t_m))}{g(y(t_m))} \right\} \frac{1}{t_m} \int_{t_m}^1 x(1-x)q(x) dx. \quad (2.14)$$

Now (2.13) and (2.14) imply

$$\int_{\varepsilon}^{y(t_m)} \frac{du}{g(u)} \leq b_0 \left\{ 1 + \frac{h(y(t_m))}{g(y(t_m))} \right\}.$$

This together with (2.9) implies $|y|_0 \neq r$. Then Theorem 1.3 implies that (2.10)^m has a solution y_m with $|y_m|_0 \leq r$. In fact (as above),

$$\frac{1}{m} \leq y_m(t) < r \quad \text{for } t \in [0, 1].$$

Next we obtain a sharper lower bound on y_m , namely we will show that there exists a constant $k > 0$, independent of m , with

$$y_m(t) \geq kt(1-t) \quad \text{for } t \in [0, 1]. \quad (2.15)$$

To see this notice (2.6) guarantees the existence of a function $\psi_r(t)$ continuous on $[0, 1]$ and positive on $(0, 1)$ with $f(t, u) \geq \psi_r(t)$ for $(t, u) \in (0, 1) \times (0, r]$. Now, using the Green's function representation for the solution of (2.10)^m, we have

$$\begin{aligned} y_m(t) &= \frac{1}{m} + t \int_t^1 (1-x)q(x)f(x, y_m(x)) dx \\ &\quad + (1-t) \int_0^t xq(x)f(x, y_m(x)) dx \end{aligned}$$

and so

$$\begin{aligned} y_m(t) &\geq t \int_t^1 (1-x)q(x)\psi_r(x) dx + (1-t) \int_0^t xq(x)\psi_r(x) dx \\ &\equiv \Phi_r(t). \end{aligned} \quad (2.16)$$

Now it is easy to check (as in Theorem 1.3) that

$$\Phi'_r(t) = \int_t^1 (1-x)q(x)\psi_r(x) dx - \int_0^t xq(x)\psi_r(x) dx \quad \text{for } t \in (0, 1)$$

with $\Phi_r(0) = \Phi_r(1) = 0$. If $k_0 \equiv \int_0^1 (1-x)q(x)\psi_r(x) dx$ exists then $\Phi'_r(0) = k_0$; otherwise $\Phi'_r(0) = \infty$. In either case there exists a constant k_1 , independent of m , with $\Phi'_r(0) \geq k_1$. Thus there is an $\varepsilon > 0$ with $\Phi_r(t) \geq \frac{1}{2}k_1t \geq \frac{1}{2}k_1t(1-t)$ for $t \in [0, \varepsilon]$. Similarly there is a constant k_2 , independent of m , with $-\Phi'_r(1) \geq k_2$. Thus there is a $\delta > 0$ with $\Phi_r(t) \geq \frac{1}{2}k_2(1-t) \geq \frac{1}{2}k_2t(1-t)$ for $t \in [1-\delta, 1]$. Finally since $\frac{\Phi_r(t)}{t(1-t)}$ is bounded on $[\varepsilon, 1-\delta]$ there is a constant k , independent of m , with $\Phi_r(t) \geq kt(1-t)$ on $[0, 1]$, i.e., (2.15) is true.

Next we will show

$$\{y_m\}_{m \in N_0} \text{ is a bounded, equicontinuous family on } [0, 1]. \tag{2.17}$$

Returning to (2.12) (with y replaced by y_m) we have

$$-y''_m(x) \leq g(y_m(x)) \left\{ 1 + \frac{h(r)}{g(r)} \right\} q(x) \quad \text{for } x \in (0, 1). \tag{2.18}$$

Now since $y''_m \leq 0$ on $(0, 1)$ and $y_m \geq \frac{1}{m}$ on $[0, 1]$ there exists $t_m \in (0, 1)$ with $y'_m \geq 0$ on $(0, t_m)$ and $y'_m \leq 0$ on $(t_m, 1)$. Integrate (2.18) from t ($t < t_m$) to t_m to obtain

$$\frac{y'_m(t)}{g(y_m(t))} \leq \left\{ 1 + \frac{h(r)}{g(r)} \right\} \int_t^{t_m} q(x) dx. \tag{2.19}$$

On the other hand integrate (2.18) from t_m to t ($t > t_m$) to obtain

$$\frac{-y'_m(t)}{g(y_m(t))} \leq \left\{ 1 + \frac{h(r)}{g(r)} \right\} \int_{t_m}^t q(x) dx. \tag{2.20}$$

We now claim that there exists a_0 and a_1 with $a_0 > 0$, $a_1 < 1$, $a_0 < a_1$ with

$$a_0 < \inf\{t_m : m \in N_0\} \leq \sup\{t_m : m \in N_0\} < a_1. \tag{2.21}$$

REMARK 2.1. Here t_m (as before) is the unique point in $(0, 1)$ with $y'_m(t_m) = 0$.

We now show $\inf\{t_m : m \in N_0\} > 0$. If this is not true then there is a subsequence S of N_0 with $t_m \rightarrow 0$ as $m \rightarrow \infty$ in S . Now integrate (2.19) from 0 to t_m to obtain

$$\int_0^{y_m(t_m)} \frac{du}{g(u)} \leq \left\{ 1 + \frac{h(r)}{g(r)} \right\} \int_0^{t_m} xq(x) dx + \int_0^{\frac{1}{m}} \frac{du}{g(u)} \tag{2.22}$$

for $m \in S$. Since $t_m \rightarrow 0$ as $m \rightarrow \infty$ in S , we have from (2.22) that $y_m(t_m) \rightarrow 0$ as $m \rightarrow \infty$ in S . However since the maximum of y_m on $[0, 1]$ occurs at t_m we have $y_m \rightarrow 0$ in $C[0, 1]$

as $m \rightarrow \infty$ in S . This contradicts (2.15). Consequently $\inf\{t_m : m \in N_0\} > 0$. A similar argument shows $\sup\{t_m : m \in N_0\} < 1$. Let a_0 and a_1 be chosen as in (2.21). Now (2.19), (2.20) and (2.21) imply

$$\frac{|y'_m(t)|}{g(y_m(t))} \leq \left\{ 1 + \frac{h(r)}{g(r)} \right\} v(t) \quad \text{for } t \in (0, 1), \quad (2.23)$$

where

$$v(t) = \int_{\min\{t, a_0\}}^{\max\{t, a_1\}} q(x) \, dx.$$

It is easy to see that $v \in L^1[0, 1]$. Let $I : [0, \infty) \rightarrow [0, \infty)$ be defined by

$$I(z) = \int_0^z \frac{du}{g(u)}.$$

Note I is an increasing map from $[0, \infty)$ onto $[0, \infty)$ (notice $I(\infty) = \infty$ since $g > 0$ is nonincreasing on $(0, \infty)$) with I continuous on $[0, A]$ for any $A > 0$. Notice

$$\{I(y_m)\}_{m \in N_0} \text{ is a bounded, equicontinuous family on } [0, 1]. \quad (2.24)$$

The equicontinuity follows from (here $t, s \in [0, 1]$)

$$|I(y_m(t)) - I(y_m(s))| = \left| \int_s^t \frac{y'_m(x)}{g(y_m(x))} \, dx \right| \leq \left\{ 1 + \frac{h(r)}{g(r)} \right\} \left| \int_s^t v(x) \, dx \right|.$$

This inequality, the uniform continuity of I^{-1} on $[0, I(r)]$, and

$$|y_m(t) - y_m(s)| = |I^{-1}(I(y_m(t))) - I^{-1}(I(y_m(s)))|$$

now establishes (2.17).

The Arzela–Ascoli theorem guarantees the existence of a subsequence N of N_0 and a function $y \in C[0, 1]$ with y_m converging uniformly on $[0, 1]$ to y as $m \rightarrow \infty$ through N . Also $y(0) = y(1) = 0$, $|y|_0 \leq r$ and $y(t) \geq kt(1-t)$ for $t \in [0, 1]$. In particular $y > 0$ on $(0, 1)$. Fix $t \in (0, 1)$ (without loss of generality assume $t \neq \frac{1}{2}$). Now $y_m, m \in N$, satisfies the integral equation

$$y_m(x) = y_m\left(\frac{1}{2}\right) + y'_m\left(\frac{1}{2}\right)\left(x - \frac{1}{2}\right) + \int_{\frac{1}{2}}^x (s-x)q(s)f(s, y_m(s)) \, ds$$

for $x \in (0, 1)$. Notice (take $x = \frac{2}{3}$) that $\{y'_m(\frac{1}{2})\}, m \in N$, is a bounded sequence since $ks(1-s) \leq y_m(s) \leq r$ for $s \in [0, 1]$. Thus $\{y'_m(\frac{1}{2})\}_{m \in N}$ has a convergent subsequence; for

convenience let $\{y'_m(\frac{1}{2})\}_{m \in N}$ denote this subsequence also and let $r_0 \in \mathbf{R}$ be its limit. Now for the above fixed t ,

$$y_m(t) = y_m\left(\frac{1}{2}\right) + y'_m\left(\frac{1}{2}\right)\left(t - \frac{1}{2}\right) + \int_{\frac{1}{2}}^t (s - t)q(s)f(s, y_m(s)) ds,$$

and let $m \rightarrow \infty$ through N (we note here that f is uniformly continuous on compact subsets of $[\min(\frac{1}{2}, t), \max(\frac{1}{2}, t)] \times (0, r]$) to obtain

$$y(t) = y\left(\frac{1}{2}\right) + r_0\left(t - \frac{1}{2}\right) + \int_{\frac{1}{2}}^t (s - t)q(s)f(s, y(s)) ds.$$

We can do this argument for each $t \in (0, 1)$ and so $y''(t) + q(t)f(t, y(t)) = 0$ for $0 < t < 1$. Finally it is easy to see that $|y|_0 < r$ (note if $|y|_0 = r$ then following essentially the argument from (2.12)–(2.14) will yield a contradiction). \square

Next we establish the existence of two nonnegative solutions to the singular second order Dirichlet problem

$$\begin{cases} y''(t) + q(t)[g(y(t)) + h(y(t))] = 0, & 0 < t < 1, \\ y(0) = y(1) = 0; \end{cases} \tag{2.25}$$

here our nonlinear term $g + h$ may be singular at $y = 0$. Next we state the fixed point result we will use to establish multiplicity (see [13] for a proof).

THEOREM 2.2. *Let $E = (E, \|\cdot\|)$ be a Banach space and let $K \subset E$ be a cone in E . Also r, R are constants with $0 < r < R$. Suppose $A: \overline{\Omega}_R \cap K \rightarrow K$ (here $\Omega_R = \{x \in E: \|x\| < R\}$) is a continuous, compact map and assume the following conditions hold:*

$$x \neq \lambda A(x) \quad \text{for } \lambda \in [0, 1) \text{ and } x \in \partial_E \Omega_r \cap K \tag{2.26}$$

and

$$\begin{cases} \text{there exists a } v \in K \setminus \{0\} \text{ with } x \neq A(x) + \delta v \\ \text{for any } \delta > 0 \text{ and } x \in \partial_E \Omega_R \cap K. \end{cases} \tag{2.27}$$

Then A has a fixed point in $K \cap \{x \in E: r \leq \|x\| \leq R\}$.

REMARK 2.2. In Theorem 2.2 if (2.26) and (2.27) are replaced by

$$x \neq \lambda A(x) \quad \text{for } \lambda \in [0, 1) \text{ and } x \in \partial_E \Omega_R \cap K \tag{2.26}^*$$

and

$$\begin{cases} \text{there exists a } v \in K \setminus \{0\} \text{ with } x \neq A(x) + \delta v \\ \text{for any } \delta > 0 \text{ and } x \in \partial_E \Omega_r \cap K \end{cases} \tag{2.27}^*$$

then A has also a fixed point in $K \cap \{x \in E: r \leq \|x\| \leq R\}$.

THEOREM 2.3. Let $E = (E, \|\cdot\|)$ be a Banach space, $K \subset E$ a cone and let $\|\cdot\|$ be increasing with respect to K . Also r, R are constants with $0 < r < R$. Suppose $A: \overline{\Omega_R} \cap K \rightarrow K$ (here $\Omega_R = \{x \in E: \|x\| < R\}$) is a continuous, compact map and assume the following conditions hold:

$$x \neq \lambda A(x) \quad \text{for } \lambda \in [0, 1) \text{ and } x \in \partial_E \Omega_r \cap K \quad (2.28)$$

and

$$\|Ax\| > \|x\| \quad \text{for } x \in \partial_E \Omega_R \cap K. \quad (2.29)$$

Then A has a fixed point in $K \cap \{x \in E: r \leq \|x\| \leq R\}$.

PROOF. Notice (2.29) guarantees that (2.27) is true. This is a standard argument and for completeness we supply it here. Suppose there exists $v \in K \setminus \{0\}$ with $x = A(x) + \delta v$ for some $\delta > 0$ and $x \in \partial_E \Omega_R \cap K$. Then since $\|\cdot\|$ is increasing with respect to K we have since $\delta v \in K$,

$$\|x\| = \|Ax + \delta v\| \geq \|Ax\| > \|x\|,$$

a contradiction. The result now follows from Theorem 2.2. □

REMARK 2.3. In Theorem 2.3 if (2.28) and (2.29) are replaced by

$$x \neq \lambda A(x) \quad \text{for } \lambda \in [0, 1) \text{ and } x \in \partial_E \Omega_r \cap K \quad (2.28)^*$$

and

$$\|Ax\| > \|x\| \quad \text{for } x \in \partial_E \Omega_r \cap K. \quad (2.29)^*$$

then A has a fixed point in $K \cap \{x \in E: r \leq \|x\| \leq R\}$.

Now $E = (C[0, 1], |\cdot|_0)$ (here $|u|_0 = \sup_{t \in [0, 1]} |u(t)|$, $u \in C[0, 1]$) will be our Banach space and

$$K = \{y \in C[0, 1]: y(t) \geq 0, t \in [0, 1] \text{ and } y(t) \text{ concave on } [0, 1]\}. \quad (2.30)$$

Let $\theta: [0, 1] \times [0, 1] \rightarrow [0, \infty)$ be defined by

$$\theta(t, s) = \begin{cases} \frac{t}{s} & \text{if } 0 \leq t \leq s, \\ \frac{1-t}{1-s} & \text{if } s \leq t \leq 1. \end{cases}$$

The following result is easy to prove and is well known.

THEOREM 2.4. *Let $y \in K$ (as in (2.30)). Then there exists $t_0 \in [0, 1]$ with $y(t_0) = |y|_0$ and*

$$y(t) \geq \theta(t, t_0)|y|_0 \geq t(1-t)|y|_0 \quad \text{for } t \in [0, 1].$$

PROOF. The existence of t_0 is immediate. Now if $0 \leq t \leq t_0$ then since $y(t)$ is concave on $[0, 1]$ we have

$$y(t) = y\left(\left(1 - \frac{t}{t_0}\right)0 + \frac{t}{t_0}t_0\right) \geq \left(1 - \frac{t}{t_0}\right)y(0) + \frac{t}{t_0}y(t_0).$$

That is

$$y(t) \geq \frac{t}{t_0}y(t_0) = \theta(t, t_0)|y|_0 \geq t(1-t)|y|_0.$$

A similar argument establishes the result if $t_0 \leq t \leq 1$. □

From Theorem 2.1 we have immediately the following existence result for (2.25).

THEOREM 2.5. *Suppose the following conditions are satisfied:*

$$q \in C(0, 1), \quad q > 0 \quad \text{on } (0, 1) \quad \text{and} \quad \int_0^1 t(1-t)q(t) dt < \infty \quad (2.31)$$

$$g > 0 \quad \text{is continuous and nonincreasing on } (0, \infty) \quad (2.32)$$

$$h \geq 0 \quad \text{continuous on } [0, \infty) \quad \text{with } \frac{h}{g} \quad \text{nondecreasing on } (0, \infty) \quad (2.33)$$

and

$$\exists r > 0 \quad \text{with} \quad \frac{1}{\{1 + \frac{h(r)}{g(r)}\}} \int_0^r \frac{du}{g(u)} > b_0; \quad (2.34)$$

here

$$b_0 = \max \left\{ 2 \int_0^{\frac{1}{2}} t(1-t)q(t) dt, 2 \int_{\frac{1}{2}}^1 t(1-t)q(t) dt \right\}. \quad (2.35)$$

Then (2.25) has a solution $y \in C[0, 1] \cap C^2(0, 1)$ with $y > 0$ on $(0, 1)$ and $|y|_0 < r$.

PROOF. The result follows from Theorem 2.1 with $f(t, u) = g(u) + h(u)$. Notice (2.6) is clearly satisfied with $\psi_H(t) = g(H)$. □

THEOREM 2.6. *Assume (2.31)–(2.34) hold. Choose $a \in (0, \frac{1}{2})$ and fix it and suppose there exists $R > r$ with*

$$\frac{Rg(a(1-a)R)}{g(R)g(a(1-a)R) + g(R)h(a(1-a)R)} \leq \int_a^{1-a} G(\sigma, s)q(s) ds; \quad (2.36)$$

here $0 \leq \sigma \leq 1$ is such that

$$\int_a^{1-a} G(\sigma, s)q(s) \, ds = \sup_{t \in [0,1]} \int_a^{1-a} G(t, s)q(s) \, ds \quad (2.37)$$

and

$$G(t, s) = \begin{cases} (1-t)s, & 0 \leq s \leq t, \\ (1-s)t, & t \leq s \leq 1. \end{cases}$$

Then (2.25) has a solution $y \in C[0, 1] \cap C^2(0, 1)$ with $y > 0$ on $(0, 1)$ and $r < |y|_0 \leq R$.

PROOF. To show the existence of the solution described in the statement of Theorem 2.6 we will apply Theorem 2.3. First however choose $\varepsilon > 0$ and $\varepsilon < r$ with

$$\frac{1}{\{1 + \frac{h(r)}{g(r)}\}} \int_\varepsilon^r \frac{du}{g(u)} > b_0. \quad (2.38)$$

Let $m_0 \in \{1, 2, \dots\}$ be chosen so that $\frac{1}{m_0} < \varepsilon$ and $\frac{1}{m_0} < a(1-a)R$ and let $N_0 = \{m_0, m_0 + 1, \dots\}$. We first show that

$$\begin{cases} y''(t) + q(t)[g(y(t)) + h(y(t))] = 0, & 0 < t < 1, \\ y(0) = y(1) = \frac{1}{m} \end{cases} \quad (2.39)^m$$

has a solution y_m for each $m \in N_0$ with $y_m > \frac{1}{m}$ on $(0, 1)$ and $r \leq |y_m|_0 \leq R$. To show (2.39)^m has such a solution for each $m \in N_0$, we will look at

$$\begin{cases} y''(t) + q(t)[g^*(y(t)) + h(y(t))] = 0, & 0 < t < 1, \\ y(0) = y(1) = \frac{1}{m} \end{cases} \quad (2.40)^m$$

with

$$g^*(u) = \begin{cases} g(u), & u \geq \frac{1}{m}, \\ g(\frac{1}{m}), & 0 \leq u \leq \frac{1}{m}. \end{cases}$$

REMARK 2.4. Notice $g^*(u) \leq g(u)$ for $u > 0$.

Fix $m \in N_0$. Let $E = (C[0, 1], |\cdot|_0)$ and

$$K = \{u \in C[0, 1]: u(t) \geq 0, t \in [0, 1] \text{ and } u(t) \text{ concave on } [0, 1]\}. \quad (2.41)$$

Clearly K is a cone of E . Let $A: K \rightarrow C[0, 1]$ be defined by

$$Ay(t) = \frac{1}{m} + \int_0^1 G(t, s)q(s)[g^*(y(s)) + h(y(s))] \, ds. \quad (2.42)$$

A standard argument implies $A : K \rightarrow C[0, 1]$ is continuous and completely continuous. Next we show $A : K \rightarrow K$. If $u \in K$ then clearly $Au(t) \geq 0$ for $t \in [0, 1]$. Also notice that

$$\begin{cases} (Au)''(t) \leq 0 & \text{on } (0, 1), \\ Au(0) = Au(1) = \frac{1}{m} \end{cases}$$

so $Au(t)$ is concave on $[0, 1]$. Consequently $Au \in K$ so $A : K \rightarrow K$. Let

$$\Omega_1 = \{u \in C[0, 1]: |u|_0 < r\} \quad \text{and} \quad \Omega_2 = \{u \in C[0, 1]: |u|_0 < R\}.$$

We first show

$$y \neq \lambda Ay \quad \text{for } \lambda \in [0, 1] \text{ and } y \in K \cap \partial\Omega_1. \tag{2.43}$$

Suppose this is false, i.e., suppose there exists $y \in K \cap \partial\Omega_1$ and $\lambda \in [0, 1]$ with $y = \lambda Ay$. We can assume $\lambda \neq 0$. Now since $y = \lambda Ay$ we have

$$\begin{cases} y''(t) + \lambda q(t)[g^*(y(t)) + h(y(t))] = 0, & 0 < t < 1, \\ y(0) = y(1) = \frac{1}{m}. \end{cases} \tag{2.44}$$

Since $y'' \leq 0$ on $(0, 1)$ and $y \geq \frac{1}{m}$ on $[0, 1]$ there exists $t_0 \in (0, 1)$ with $y' \geq 0$ on $(0, t_0)$, $y' \leq 0$ on $(t_0, 1)$ and $y(t_0) = |y|_0 = r$ (note $y \in K \cap \partial\Omega_1$). Also notice

$$g^*(y(t)) + h(y(t)) \leq g(y(t)) + h(y(t)) \quad \text{for } t \in (0, 1)$$

since g is nonincreasing on $(0, \infty)$. For $x \in (0, 1)$ we have

$$-y''(x) \leq g(y(x)) \left\{ 1 + \frac{h(y(x))}{g(y(x))} \right\} q(x). \tag{2.45}$$

Integrate from t ($t \leq t_0$) to t_0 to obtain

$$y'(t) \leq g(y(t)) \left\{ 1 + \frac{h(r)}{g(r)} \right\} \int_t^{t_0} q(x) \, dx$$

and then integrate from 0 to t_0 to obtain

$$\int_{\frac{1}{m}}^r \frac{du}{g(u)} \leq \left\{ 1 + \frac{h(r)}{g(r)} \right\} \int_0^{t_0} x q(x) \, dx.$$

Consequently

$$\int_{\varepsilon}^r \frac{du}{g(u)} \leq \left\{ 1 + \frac{h(r)}{g(r)} \right\} \int_0^{t_0} x q(x) \, dx$$

and so

$$\int_{\varepsilon}^r \frac{du}{g(u)} \leq \left\{ 1 + \frac{h(r)}{g(r)} \right\} \frac{1}{1-t_0} \int_0^{t_0} x(1-x)q(x) dx. \quad (2.46)$$

Similarly if we integrate (2.45) from t_0 to t ($t \geq t_0$) and then from t_0 to 1 we obtain

$$\int_{\varepsilon}^r \frac{du}{g(u)} \leq \left\{ 1 + \frac{h(r)}{g(r)} \right\} \frac{1}{t_0} \int_{t_0}^1 x(1-x)q(x) dx. \quad (2.47)$$

Now (2.46) and (2.47) imply

$$\int_{\varepsilon}^r \frac{du}{g(u)} \leq b_0 \left\{ 1 + \frac{h(r)}{g(r)} \right\}, \quad (2.48)$$

where b_0 is as defined in (2.35). This contradicts (2.38) and consequently (2.43) is true.

Next we show

$$|Ay|_0 > |y|_0 \quad \text{for } y \in K \cap \partial\Omega_2. \quad (2.49)$$

To see this let $y \in K \cap \partial\Omega_2$ so $|y|_0 = R$. Also since $y(t)$ is concave on $[0, 1]$ (since $y \in K$) we have from Theorem 2.4 that $y(t) \geq t(1-t)|y|_0 \geq t(1-t)R$ for $t \in [0, 1]$. Also for $s \in [a, 1-a]$ we have

$$g^*(y(s)) + h(y(s)) = g(y(s)) + h(y(s))$$

since $y(s) \geq a(1-a)R > \frac{1}{m_0}$ for $s \in [a, 1-a]$. Note in particular that

$$y(s) \in [a(1-a)R, R] \quad \text{for } s \in [a, 1-a]. \quad (2.50)$$

With σ as defined in (2.37) we have using (2.50) and (2.36),

$$\begin{aligned} Ay(\sigma) &= \frac{1}{m} + \int_0^1 G(\sigma, s)q(s)[g^*(y(s)) + h(y(s))] ds \\ &> \int_a^{1-a} G(\sigma, s)q(s)[g^*(y(s)) + h(y(s))] ds \\ &= \int_a^{1-a} G(\sigma, s)q(s)g(y(s)) \left\{ 1 + \frac{h(y(s))}{g(y(s))} \right\} ds \\ &\geq g(R) \left\{ 1 + \frac{h(a(1-a)R)}{g(a(1-a)R)} \right\} \int_a^{1-a} G(\sigma, s)q(s) ds \\ &\geq R = |y|_0, \end{aligned}$$

and so $|Ay|_0 > |y|_0$. Hence (2.49) is true.

Now Theorem 2.3 implies A has a fixed point $y_m \in K \cap (\overline{\Omega_2} \setminus \Omega_1)$, i.e., $r \leq |y_m|_0 \leq R$. In fact $|y_m|_0 > r$ (note if $|y_m|_0 = r$ then following essentially the same argument from (2.45)–(2.48) will yield a contradiction). Consequently $(2.40)^m$ (and also $(2.39)^m$) has a solution $y_m \in C[0, 1] \cap C^2(0, 1)$, $y_m \in K$, with

$$\frac{1}{m} \leq y_m(t) \quad \text{for } t \in [0, 1], \quad r < |y_m|_0 \leq R \tag{2.51}$$

and (from Theorem 2.4, note $y_m \in K$)

$$y_m(t) \geq t(1-t)r \quad \text{for } t \in [0, 1]. \tag{2.52}$$

Next we will show

$$\{y_m\}_{m \in N_0} \quad \text{is a bounded, equicontinuous family on } [0, 1]. \tag{2.53}$$

Returning to (2.45) (with y replaced by y_m) we have

$$-y_m''(x) \leq g(y_m(x)) \left\{ 1 + \frac{h(R)}{g(R)} \right\} q(x) \quad \text{for } x \in (0, 1). \tag{2.54}$$

Now since $y_m'' \leq 0$ on $(0, 1)$ and $y_m \geq \frac{1}{m}$ on $[0, 1]$ there exists $t_m \in (0, 1)$ with $y_m' \geq 0$ on $(0, t_m)$ and $y_m' \leq 0$ on $(t_m, 1)$. Integrate (2.54) from t ($t < t_m$) to t_m to obtain

$$\frac{y_m'(t)}{g(y_m(t))} \leq \left\{ 1 + \frac{h(R)}{g(R)} \right\} \int_t^{t_m} q(x) \, dx. \tag{2.55}$$

On the other hand integrate (2.54) from t_m to t ($t > t_m$) to obtain

$$\frac{-y_m'(t)}{g(y_m(t))} \leq \left\{ 1 + \frac{h(R)}{g(R)} \right\} \int_{t_m}^t q(x) \, dx. \tag{2.56}$$

We now claim that there exists a_0 and a_1 with $a_0 > 0$, $a_1 < 1$, $a_0 < a_1$ with

$$a_0 < \inf\{t_m : m \in N_0\} \leq \sup\{t_m : m \in N_0\} < a_1. \tag{2.57}$$

REMARK 2.5. Here t_m (as before) is the unique point in $(0, 1)$ with $y_m'(t_m) = 0$.

We now show $\inf\{t_m : m \in N_0\} > 0$. If this is not true then there is a subsequence S of N_0 with $t_m \rightarrow 0$ as $m \rightarrow \infty$ in S . Now integrate (2.55) from 0 to t_m to obtain

$$\int_0^{y_m(t_m)} \frac{du}{g(u)} \leq \left\{ 1 + \frac{h(R)}{g(R)} \right\} \int_0^{t_m} xq(x) \, dx + \int_0^{\frac{1}{m}} \frac{du}{g(u)} \tag{2.58}$$

for $m \in S$. Since $t_m \rightarrow 0$ as $m \rightarrow \infty$ in S , we have from (2.58) that $y_m(t_m) \rightarrow 0$ as $m \rightarrow \infty$ in S . However since the maximum of y_m on $[0, 1]$ occurs at t_m we have $y_m \rightarrow 0$ in $C[0, 1]$

as $m \rightarrow \infty$ in S . This contradicts (2.52). Consequently $\inf\{t_m : m \in N_0\} > 0$. A similar argument shows $\sup\{t_m : m \in N_0\} < 1$. Let a_0 and a_1 be chosen as in (2.57). Now (2.55), (2.56) and (2.57) imply

$$\frac{|y'_m(t)|}{g(y_m(t))} \leq \left\{ 1 + \frac{h(R)}{g(R)} \right\} v(t) \quad \text{for } t \in (0, 1), \quad (2.59)$$

where

$$v(t) = \int_{\min\{t, a_0\}}^{\max\{t, a_1\}} q(x) \, dx.$$

It is easy to see that $v \in L^1[0, 1]$. Let $I : [0, \infty) \rightarrow [0, \infty)$ be defined by

$$I(z) = \int_0^z \frac{du}{g(u)}.$$

Note I is an increasing map from $[0, \infty)$ onto $[0, \infty)$ (notice $I(\infty) = \infty$ since $g > 0$ is nonincreasing on $(0, \infty)$) with I continuous on $[0, A]$ for any $A > 0$. Notice

$$\{I(y_m)\}_{m \in N_0} \text{ is a bounded, equicontinuous family on } [0, 1]. \quad (2.60)$$

The equicontinuity follows from (here $t, s \in [0, 1]$)

$$|I(y_m(t)) - I(y_m(s))| = \left| \int_s^t \frac{y'_m(x)}{g(y_m(x))} \, dx \right| \leq \left\{ 1 + \frac{h(R)}{g(R)} \right\} \left| \int_s^t v(x) \, dx \right|.$$

This inequality, the uniform continuity of I^{-1} on $[0, I(R)]$, and

$$|y_m(t) - y_m(s)| = |I^{-1}(I(y_m(t))) - I^{-1}(I(y_m(s)))|$$

now establishes (2.53).

The Arzela–Ascoli theorem guarantees the existence of a subsequence N of N_0 and a function $y \in C[0, 1]$ with y_m converging uniformly on $[0, 1]$ to y as $m \rightarrow \infty$ through N . Also $y(0) = y(1) = 0$, $r \leq |y|_0 \leq R$ and $y(t) \geq t(1-t)r$ for $t \in [0, 1]$. In particular $y > 0$ on $(0, 1)$. Fix $t \in (0, 1)$ (without loss of generality assume $t \neq \frac{1}{2}$). Now $y_m, m \in N$, satisfies the integral equation

$$\begin{aligned} y_m(x) &= y_m\left(\frac{1}{2}\right) + y'_m\left(\frac{1}{2}\right)\left(x - \frac{1}{2}\right) \\ &\quad + \int_{\frac{1}{2}}^x (s-x)q(s)[g(y_m(s)) + h(y_m(s))] \, ds \end{aligned}$$

for $x \in (0, 1)$. Notice (take $x = \frac{2}{3}$) that $\{y'_m(\frac{1}{2})\}$, $m \in N$, is a bounded sequence since $rs(1-s) \leq y_m(s) \leq R$ for $s \in [0, 1]$. Thus $\{y'_m(\frac{1}{2})\}_{m \in N}$ has a convergent subsequence; for

convenience let $\{y'_m(\frac{1}{2})\}_{m \in N}$ denote this subsequence also and let $r_0 \in \mathbf{R}$ be its limit. Now for the above fixed t ,

$$y_m(t) = y_m\left(\frac{1}{2}\right) + y'_m\left(\frac{1}{2}\right)\left(t - \frac{1}{2}\right) + \int_{\frac{1}{2}}^t (s - t)q(s)[g(y_m(s)) + h(y_m(s))] ds,$$

and let $m \rightarrow \infty$ through N (we note here that $g + h$ is uniformly continuous on compact subsets of $[\min(\frac{1}{2}, t), \max(\frac{1}{2}, t)] \times (0, R]$) to obtain

$$y(t) = y\left(\frac{1}{2}\right) + r_0\left(t - \frac{1}{2}\right) + \int_{\frac{1}{2}}^t (s - t)q(s)[g(y(s)) + h(y(s))] ds.$$

We can do this argument for each $t \in (0, 1)$ and so $y''(t) + q(t)[g(y(t)) + h(y(t))] = 0$ for $0 < t < 1$. Finally it is easy to see that $|y|_0 > r$ (note if $|y|_0 = r$ then following essentially the argument from (2.45)–(2.48) will yield a contradiction). \square

REMARK 2.6. If in (2.36) we have $R < r$ then (2.25) has a solution $y \in C[0, 1] \cap C^2(0, 1)$ with $y > 0$ on $(0, 1)$ and $R \leq |y|_0 < r$. The argument is similar to that in Theorem 2.6 except here we use Remark 2.3.

REMARK 2.7. It is also possible to use the ideas in Theorem 2.6 to discuss other boundary conditions; for example $y'(0) = y(1) = 0$.

REMARK 2.8. If we use Krasnoselski's fixed point theorem in a cone we need more that (2.31)–(2.34), (2.36) to establish the existence of a solution $y \in C[0, 1] \cap C^2(0, 1)$ with $y > 0$ on $(0, 1)$ and $r < |y|_0 \leq R$. This is because (2.43) is less restrictive than $|Ay|_0 \leq |y|_0$ for $y \in K \cap \partial\Omega_1$.

THEOREM 2.7. Assume (2.31)–(2.34) and (2.36) hold. Then (2.25) has two solutions $y_1, y_2 \in C[0, 1] \cap C^2(0, 1)$ with $y_1 > 0, y_2 > 0$ on $(0, 1)$ and $|y_1|_0 < r < |y_2|_0 \leq R$.

PROOF. The existence of y_1 follows from Theorem 2.5 and the existence of y_2 follows from Theorem 2.6. \square

EXAMPLE 2.1. The singular boundary value problem

$$\begin{cases} y'' + \frac{1}{\alpha+1}(y^{-\alpha} + y^\beta + 1) = 0 & \text{on } (0, 1), \\ y(0) = y(1) = 0, & \alpha > 0, \beta > 1 \end{cases} \tag{2.61}$$

has two solutions $y_1, y_2 \in C[0, 1] \cap C^2(0, 1)$ with $y_1 > 0, y_2 > 0$ on $(0, 1)$ and $|y_1|_0 < 1 < |y_2|_0$.

To see this we will apply Theorem 2.7 with $q = \frac{1}{\alpha+1}$, $g(u) = u^{-\alpha}$ and $h(u) = u^\beta + 1$. Clearly (2.31)–(2.33) hold. Also note

$$b_0 = \max \left\{ \frac{2}{\alpha+1} \int_0^{\frac{1}{2}} t(1-t) dt, \frac{2}{\alpha+1} \int_{\frac{1}{2}}^1 t(1-t) dt \right\} = \frac{1}{6(\alpha+1)}.$$

Consequently (2.34) holds (with $r = 1$) since

$$\begin{aligned} \frac{1}{\left\{1 + \frac{h(r)}{g(r)}\right\}} \int_0^r \frac{du}{g(u)} &= \frac{1}{(1 + r^{\alpha+\beta} + r^\alpha)} \left(\frac{r^{\alpha+1}}{\alpha+1} \right) \\ &= \frac{1}{3(\alpha+1)} > b_0 = \frac{1}{6(\alpha+1)}. \end{aligned}$$

Finally note (since $\beta > 1$), take $a = \frac{1}{4}$, that

$$\lim_{R \rightarrow \infty} \frac{Rg\left(\frac{3R}{16}\right)}{g(R)g\left(\frac{3R}{16}\right) + g(R)h\left(\frac{3R}{16}\right)} = \lim_{R \rightarrow \infty} \frac{R^{\alpha+1}\left(\frac{3}{16}\right)^{-\alpha}}{\left(\frac{3}{16}\right)^{-\alpha} + \left(\frac{3}{16}\right)^\beta R^{\alpha+\beta} + R^\alpha} = 0$$

so there exists $R > 1$ with (2.36) holding. The result now follows from Theorem 2.7.

2.2. Singular problems with sign changing nonlinearities

In this section we discuss the Dirichlet singular boundary value problem

$$\begin{cases} y'' + q(t)f(t, y) = 0, & 0 < t < 1, \\ y(0) = y(1) = 0, \end{cases} \quad (2.62)$$

where our nonlinearity f may change sign. We first present a variation of the classical theory of upper and lower solutions in this section so that (2.62) can be discussed in its natural setting. We assume the following conditions hold:

$$\begin{cases} \text{there exists } \beta \in C[0, 1] \cap C^2(0, 1), \\ \beta(0) \geq 0, \quad q(t)f(t, \beta(t)) + \beta''(t) \leq 0 \\ \text{for } t \in (0, 1), \text{ and } \beta(1) \geq 0, \end{cases} \quad (2.63)$$

$$\begin{cases} \text{there exists } \alpha \in C[0, 1] \cap C^2(0, 1), \quad \alpha(t) \leq \beta(t) \\ \text{on } [0, 1], \quad \alpha(0) \leq 0, \quad q(t)f(t, \alpha(t)) + \alpha''(t) \geq 0 \\ \text{for } t \in (0, 1), \text{ and } \alpha(1) \leq 0 \end{cases} \quad (2.64)$$

and

$$\begin{cases} q \in C(0, 1) \text{ with } q > 0 \text{ on } (0, 1) \text{ and} \\ \int_0^1 t(1-t)q(t) dt < \infty. \end{cases} \quad (2.65)$$

Let

$$f^*(t, y) = \begin{cases} f(t, \beta(t)) + r(\beta(t) - y), & y \geq \beta(t), \\ f(t, y), & \alpha(t) < y < \beta(t), \\ f(t, \alpha(t)) + r(\alpha(t) - y), & y \leq \alpha(t) \end{cases}$$

and $r : \mathbf{R} \rightarrow [-1, 1]$ is the radial retraction defined by

$$r(x) = \begin{cases} x, & |x| \leq 1, \\ \frac{x}{|x|}, & |x| > 1. \end{cases}$$

Finally we assume

$$f^* : [0, 1] \times \mathbf{R} \rightarrow \mathbf{R} \text{ is continuous.} \tag{2.66}$$

THEOREM 2.8. *Suppose (2.63)–(2.66) hold. Then (2.62) has a solution y (here $y \in C[0, 1] \cap C^2(0, 1)$) with $\alpha(t) \leq y(t) \leq \beta(t)$ for $t \in [0, 1]$.*

PROOF. To show (2.62) has a solution we consider the problem

$$\begin{cases} y'' + q(t)f^*(t, y) = 0, & 0 < t < 1, \\ y(0) = y(1) = 0. \end{cases} \tag{2.67}$$

Theorem 1.4 guarantees that (2.67) has a solution $y \in C[0, 1] \cap C^2(0, 1)$. The result of our theorem will follow once we show

$$\alpha(t) \leq y(t) \leq \beta(t) \quad \text{for } t \in [0, 1]. \tag{2.68}$$

We now show

$$y(t) \leq \beta(t) \quad \text{for } t \in [0, 1]. \tag{2.69}$$

Suppose (2.69) is not true. Then $y - \beta$ has a positive absolute maximum at $t_1 \in (0, 1)$. As a result $(y - \beta)'(t_1) = 0$ and $(y - \beta)''(t_1) \leq 0$. However since $y(t_1) > \beta(t_1)$ we have

$$\begin{aligned} (y - \beta)''(t_1) &= -q(t_1)[f(t_1, \beta(t_1)) + r(\beta(t_1) - y(t_1))] - \beta''(t_1) \\ &\geq -q(t_1)r(\beta(t_1) - y(t_1)) > 0, \end{aligned}$$

a contradiction. Thus (2.69) is true. Similarly we can show

$$\alpha(t) \leq y(t) \quad \text{for } t \in [0, 1]. \tag{2.70}$$

Our result follows. □

In general if we construct an upper solution β and a lower solution α to (2.62), usually it is difficult to check (2.66). As a result it is of interest to provide an alternative approach and to provide conditions that are easy to verify in applications.

THEOREM 2.9. *Let $n_0 \in \{1, 2, \dots\}$ be fixed and suppose the following conditions are satisfied:*

$$f : [0, 1] \times (0, \infty) \rightarrow \mathbf{R} \quad \text{is continuous} \tag{2.71}$$

$$\left\{ \begin{array}{l} \text{let } n \in \{n_0, n_0 + 1, \dots\} \text{ and associated with each } n \text{ we} \\ \text{have a constant } \rho_n \text{ such that } \{\rho_n\} \text{ is a nonincreasing} \\ \text{sequence with } \lim_{n \rightarrow \infty} \rho_n = 0 \text{ and such that for} \\ \frac{1}{2^{n+1}} \leq t \leq 1 \text{ we have } q(t) f(t, \rho_n) \geq 0, \end{array} \right. \tag{2.72}$$

$$q \in C(0, 1), \quad q > 0 \quad \text{on } (0, 1) \quad \text{and} \quad \int_0^1 x(1-x)q(x) dx < \infty, \tag{2.73}$$

$$\left\{ \begin{array}{l} \text{there exists a function } \alpha \in C[0, 1] \cap C^2(0, 1) \\ \text{with } \alpha(0) = \alpha(1) = 0, \alpha > 0 \text{ on } (0, 1) \text{ such} \\ \text{that } q(t) f(t, \alpha(t)) + \alpha''(t) \geq 0 \text{ for } t \in (0, 1) \end{array} \right. \tag{2.74}$$

and

$$\left\{ \begin{array}{l} \text{there exists a function } \beta \in C[0, 1] \cap C^2(0, 1) \\ \text{with } \beta(t) \geq \alpha(t) \text{ and } \beta(t) \geq \rho_{n_0} \text{ for } t \in [0, 1] \\ \text{with } q(t) f(t, \beta(t)) + \beta''(t) \leq 0 \text{ for } t \in (0, 1) \text{ and} \\ q(t) f\left(\frac{1}{2^{n_0+1}}, \beta(t)\right) + \beta''(t) \leq 0 \text{ for } t \in \left(0, \frac{1}{2^{n_0+1}}\right). \end{array} \right. \tag{2.75}$$

Then (2.62) has a solution $y \in C[0, 1] \cap C^2(0, 1)$ with $y(t) \geq \alpha(t)$ for $t \in [0, 1]$.

PROOF. For $n = n_0, n_0 + 1, \dots$ let

$$e_n = \left[\frac{1}{2^{n+1}}, 1 \right] \quad \text{and} \quad \theta_n(t) = \max \left\{ \frac{1}{2^{n+1}}, t \right\}, \quad 0 \leq t \leq 1,$$

and

$$f_n(t, x) = \max \{ f(\theta_n(t), x), f(t, x) \}.$$

Next we define inductively

$$g_{n_0}(t, x) = f_{n_0}(t, x)$$

and

$$g_n(t, x) = \min \{ f_{n_0}(t, x), \dots, f_n(t, x) \}, \quad n = n_0 + 1, n_0 + 2, \dots$$

Notice

$$f(t, x) \leq \dots \leq g_{n+1}(t, x) \leq g_n(t, x) \leq \dots \leq g_{n_0}(t, x)$$

for $(t, x) \in (0, 1) \times (0, \infty)$ and

$$g_n(t, x) = f(t, x) \quad \text{for } (t, x) \in e_n \times (0, \infty).$$

Without loss of generality assume $\rho_{n_0} \leq \min_{t \in [\frac{1}{3}, \frac{2}{3}]} \alpha(t)$. Fix $n \in \{n_0, n_0 + 1, \dots\}$. Let $t_n \in [0, \frac{1}{3}]$ and $s_n \in [\frac{2}{3}, 1]$ be such that

$$\alpha(t_n) = \alpha(s_n) = \rho_n \quad \text{and} \quad \alpha(t) \leq \rho_n \quad \text{for } t \in [0, t_n] \cup [s_n, 1].$$

Define

$$\alpha_n(t) = \begin{cases} \rho_n & \text{if } t \in [0, t_n] \cup [s_n, 1], \\ \alpha(t) & \text{if } t \in (t_n, s_n). \end{cases}$$

We begin with the boundary value problem

$$\begin{cases} y'' + q(t)g_{n_0}^*(t, y) = 0, & 0 < t < 1, \\ y(0) = y(1) = \rho_{n_0}; \end{cases} \tag{2.76}$$

here

$$g_{n_0}^*(t, y) = \begin{cases} g_{n_0}(t, \alpha_{n_0}(t)) + r(\alpha_{n_0}(t) - y), & y \leq \alpha_{n_0}(t), \\ g_{n_0}(t, y), & \alpha_{n_0}(t) \leq y \leq \beta(t), \\ g_{n_0}(t, \beta(t)) + r(\beta(t) - y), & y \geq \beta(t), \end{cases}$$

with $r : \mathbf{R} \rightarrow [-1, 1]$ the radial retraction defined by

$$r(u) = \begin{cases} u, & |u| \leq 1, \\ \frac{u}{|u|}, & |u| > 1. \end{cases}$$

From Schauder's fixed point theorem we know that (2.76) has a solution $y_{n_0} \in C[0, 1] \cap C^2(0, 1)$. We first show

$$y_{n_0}(t) \geq \alpha_{n_0}(t), \quad t \in [0, 1]. \tag{2.77}$$

Suppose (2.77) is not true. Then $y_{n_0} - \alpha_{n_0}$ has a negative absolute minimum at $\tau \in (0, 1)$. Now since $y_{n_0}(0) - \alpha_{n_0}(0) = 0 = y_{n_0}(1) - \alpha_{n_0}(1)$ there exists $\tau_0, \tau_1 \in [0, 1]$ with $\tau \in (\tau_1, \tau_2)$ and

$$y_{n_0}(\tau_0) - \alpha_{n_0}(\tau_0) = y_{n_0}(\tau_1) - \alpha_{n_0}(\tau_1) = 0$$

and

$$y_{n_0}(t) - \alpha_{n_0}(t) < 0, \quad t \in (\tau_0, \tau_1).$$

We now claim

$$(y_{n_0} - \alpha_{n_0})''(t) < 0 \quad \text{for a.e. } t \in (\tau_0, \tau_1). \quad (2.78)$$

If (2.78) is true then

$$y_{n_0}(t) - \alpha_{n_0}(t) = - \int_{\tau_0}^{\tau_1} G(t, s) [y_{n_0}''(s) - \alpha_{n_0}''(s)] ds \quad \text{for } t \in (\tau_0, \tau_1)$$

with

$$G(t, s) = \begin{cases} \frac{(s-\tau_0)(\tau_1-t)}{\tau_1-\tau_0}, & \tau_0 \leq s \leq t, \\ \frac{(t-\tau_0)(\tau_1-s)}{\tau_1-\tau_0}, & t \leq s \leq \tau_1 \end{cases}$$

so we have

$$y_{n_0}(t) - \alpha_{n_0}(t) > 0 \quad \text{for } t \in (\tau_0, \tau_1),$$

a contradiction. As a result if we show that (2.78) is true then (2.77) will follow. To see (2.78) we will show

$$(y_{n_0} - \alpha_{n_0})''(t) < 0 \quad \text{for } t \in (\tau_0, \tau_1) \text{ provided } t \neq t_{n_0} \text{ or } t \neq s_{n_0}.$$

Fix $t \in (\tau_0, \tau_1)$ and assume $t \neq t_{n_0}$ or $t \neq s_{n_0}$. Then

$$\begin{aligned} (y_{n_0} - \alpha_{n_0})''(t) &= -[q(t)\{g_{n_0}(t, \alpha_{n_0}(t)) + r(\alpha_{n_0}(t) - y_{n_0}(t))\} + \alpha_{n_0}''(t)] \\ &= \begin{cases} -[q(t)\{g_{n_0}(t, \alpha(t)) + r(\alpha(t) - y_{n_0}(t))\} + \alpha''(t)] \\ \quad \text{if } t \in (t_{n_0}, s_{n_0}), \\ -[q(t)\{g_{n_0}(t, \rho_{n_0}) + r(\rho_{n_0} - y_{n_0}(t))\}] \\ \quad \text{if } t \in (0, t_{n_0}) \cup (s_{n_0}, 1). \end{cases} \end{aligned}$$

Case (i). $t \geq \frac{1}{2^{n_0+1}}$.

Then since $g_{n_0}(t, x) = f(t, x)$ for $x \in (0, \infty)$ we have

$$\begin{aligned} (y_{n_0} - \alpha_{n_0})''(t) &= \begin{cases} -[q(t)\{f(t, \alpha(t)) + r(\alpha(t) - y_{n_0}(t))\} + \alpha''(t)] \\ \quad \text{if } t \in (t_{n_0}, s_{n_0}), \\ -[q(t)\{f(t, \rho_{n_0}) + r(\rho_{n_0} - y_{n_0}(t))\}] \\ \quad \text{if } t \in (0, t_{n_0}) \cup (s_{n_0}, 1) \end{cases} \\ &< 0, \end{aligned}$$

from (2.72) and (2.74).

Case (ii). $t \in (0, \frac{1}{2^{n_0+1}})$.

Then since

$$g_{n_0}(t, x) = \max \left\{ f \left(\frac{1}{2^{n_0+1}}, x \right), f(t, x) \right\}$$

we have

$$g_{n_0}(t, x) \geq f(t, x) \quad \text{and} \quad g_{n_0}(t, x) \geq f \left(\frac{1}{2^{n_0+1}}, x \right)$$

for $x \in (0, \infty)$. Thus we have

$$(y_{n_0} - \alpha_{n_0})''(t) \leq \begin{cases} -[q(t)\{f(t, \alpha(t)) + r(\alpha(t) - y_{n_0}(t))\} + \alpha''(t)] \\ \quad \text{if } t \in (t_{n_0}, s_{n_0}), \\ -[q(t)\{f(\frac{1}{2^{n_0+1}}, \rho_{n_0}) + r(\rho_{n_0} - y_{n_0}(t))\}] \\ \quad \text{if } t \in (0, t_{n_0}) \cup (s_{n_0}, 1) \end{cases} < 0$$

from (2.72) and (2.74).

Consequently (2.78) (and so (2.77)) holds and now since $\alpha(t) \leq \alpha_{n_0}(t)$ for $t \in [0, 1]$ we have

$$\alpha(t) \leq \alpha_{n_0}(t) \leq y_{n_0}(t) \quad \text{for } t \in [0, 1]. \tag{2.79}$$

Next we show

$$y_{n_0}(t) \leq \beta(t) \quad \text{for } t \in [0, 1]. \tag{2.80}$$

If (2.80) is not true then $y_{n_0} - \beta$ would have a positive absolute maximum at say $\tau_0 \in (0, 1)$, in which case $(y_{n_0} - \beta)'(\tau_0) = 0$ and $(y_{n_0} - \beta)''(\tau_0) \leq 0$. There are two cases to consider, namely $\tau_0 \in [\frac{1}{2^{n_0+1}}, 1)$ and $\tau_0 \in (0, \frac{1}{2^{n_0+1}})$.

Case (i). $\tau_0 \in [\frac{1}{2^{n_0+1}}, 1)$.

Then $y_{n_0}(\tau_0) > \beta(\tau_0)$ together with $g_{n_0}(\tau_0, x) = f(\tau_0, x)$ for $x \in (0, \infty)$ gives

$$\begin{aligned} (y_{n_0} - \beta)''(\tau_0) &= -q(\tau_0)[g_{n_0}(\tau_0, \beta(\tau_0)) + r(\beta(\tau_0) - y_{n_0}(\tau_0))] - \beta''(\tau_0) \\ &= -q(\tau_0)[f(\tau_0, \beta(\tau_0)) + r(\beta(\tau_0) - y_{n_0}(\tau_0))] - \beta''(\tau_0) \\ &> 0 \end{aligned}$$

from (2.75), a contradiction.

Case (ii). $\tau_0 \in (0, \frac{1}{2^{n_0+1}})$.

Then $y_{n_0}(\tau_0) > \beta(\tau_0)$ together with

$$g_{n_0}(\tau_0, x) = \max \left\{ f \left(\frac{1}{2^{n_0+1}}, x \right), f(\tau_0, x) \right\}$$

for $x \in (0, \infty)$ gives

$$\begin{aligned} (y_{n_0} - \beta)''(\tau_0) &= -q(\tau_0) \left[\max \left\{ f \left(\frac{1}{2^{n_0+1}}, \beta(\tau_0) \right), f(\tau_0, \beta(\tau_0)) \right\} \right. \\ &\quad \left. + r(\beta(\tau_0) - y_{n_0}(\tau_0)) \right] - \beta''(\tau_0) \\ &> 0 \end{aligned}$$

from (2.75), a contradiction.

Thus (2.80) holds, so we have

$$\alpha(t) \leq \alpha_{n_0}(t) \leq y_{n_0}(t) \leq \beta(t) \quad \text{for } t \in [0, 1].$$

Next we consider the boundary value problem

$$\begin{cases} y'' + q(t)g_{n_0+1}^*(t, y) = 0, & 0 < t < 1, \\ y(0) = y(1) = \rho_{n_0+1}; \end{cases} \tag{2.81}$$

here

$$g_{n_0+1}^*(t, y) = \begin{cases} g_{n_0+1}(t, \alpha_{n_0+1}(t)) + r(\alpha_{n_0+1}(t) - y), & y \leq \alpha_{n_0+1}(t), \\ g_{n_0+1}(t, y), & \alpha_{n_0+1}(t) \leq y \leq y_{n_0}(t), \\ g_{n_0+1}(t, y_{n_0}(t)) + r(y_{n_0}(t) - y), & y \geq y_{n_0}(t). \end{cases}$$

Now Schauder's fixed point theorem guarantees that (2.81) has a solution $y_{n_0+1} \in C[0, 1] \cap C^2(0, 1)$. We first show

$$y_{n_0+1}(t) \geq \alpha_{n_0+1}(t), \quad t \in [0, 1]. \tag{2.82}$$

Suppose (2.82) is not true. Then there exists $\tau_0, \tau_1 \in [0, 1]$ with

$$y_{n_0+1}(\tau_0) - \alpha_{n_0+1}(\tau_0) = y_{n_0+1}(\tau_1) - \alpha_{n_0+1}(\tau_1) = 0$$

and

$$y_{n_0+1}(t) - \alpha_{n_0+1}(t) < 0, \quad t \in (\tau_0, \tau_1).$$

If we show

$$(y_{n_0+1} - \alpha_{n_0+1})''(t) < 0 \quad \text{for a.e. } t \in (\tau_0, \tau_1), \tag{2.83}$$

then as before (2.82) is true. Fix $t \in (\tau_0, \tau_1)$ and assume $t \neq t_{n_0+1}$ or $t \neq s_{n_0+1}$. Then

$$(y_{n_0+1} - \alpha_{n_0+1})''(t) = \begin{cases} -[q(t)\{g_{n_0+1}(t, \alpha(t)) + r(\alpha(t) - y_{n_0+1}(t))\} + \alpha''(t)] \\ \quad \text{if } t \in (t_{n_0+1}, s_{n_0+1}), \\ -[q(t)\{g_{n_0+1}(t, \rho_{n_0+1}) + r(\rho_{n_0+1} - y_{n_0+1}(t))\}] \\ \quad \text{if } t \in (0, t_{n_0+1}) \cup (s_{n_0+1}, 1). \end{cases}$$

Case (i). $t \geq \frac{1}{2^{n_0+2}}$.

Then since $g_{n_0+1}(t, x) = f(t, x)$ for $x \in (0, \infty)$ we have

$$(y_{n_0+1} - \alpha_{n_0+1})''(t) = \begin{cases} -[q(t)\{f(t, \alpha(t)) + r(\alpha(t) - y_{n_0+1}(t))\} + \alpha''(t)] \\ \quad \text{if } t \in (t_{n_0+1}, s_{n_0+1}), \\ -[q(t)\{f(t, \rho_{n_0+1}) + r(\rho_{n_0+1} - y_{n_0+1}(t))\}] \\ \quad \text{if } t \in (0, t_{n_0+1}) \cup (s_{n_0+1}, 1) \end{cases} < 0,$$

from (2.72) and (2.74).

Case (ii). $t \in (0, \frac{1}{2^{n_0+2}})$.

Then since $g_{n_0+1}(t, x)$ equals

$$\min \left\{ \max \left\{ f \left(\frac{1}{2^{n_0+1}}, x \right), f(t, x) \right\}, \max \left\{ f \left(\frac{1}{2^{n_0+2}}, x \right), f(t, x) \right\} \right\}$$

we have

$$g_{n_0+1}(t, x) \geq f(t, x)$$

and

$$g_{n_0+1}(t, x) \geq \min \left\{ f \left(\frac{1}{2^{n_0+1}}, x \right), f \left(\frac{1}{2^{n_0+2}}, x \right) \right\}$$

for $x \in (0, \infty)$. Thus we have

$$(y_{n_0+1} - \alpha_{n_0+1})''(t) \leq \begin{cases} -[q(t)\{f(t, \alpha(t)) + r(\alpha(t) - y_{n_0+1}(t))\} + \alpha''(t)] \\ \quad \text{if } t \in (t_{n_0+1}, s_{n_0+1}), \\ -[q(t)\{\min\{f(\frac{1}{2^{n_0+1}}, \rho_{n_0+1}), f(\frac{1}{2^{n_0+2}}, \rho_{n_0+1})\} \\ \quad + r(\rho_{n_0+1} - y_{n_0+1}(t))\}], \\ \quad \text{if } t \in (0, t_{n_0+1}) \cup (s_{n_0+1}, 1) \end{cases} < 0,$$

from (2.72) and (2.74) (note $f(\frac{1}{2^{n_0+1}}, \rho_{n_0+1}) \geq 0$ since $f(t, \rho_{n_0+1}) \geq 0$ for $t \in [\frac{1}{2^{n_0+2}}, 1]$ and $\frac{1}{2^{n_0+1}} \in (\frac{1}{2^{n_0+2}}, 1)$).

Consequently (2.82) is true so

$$\alpha(t) \leq \alpha_{n_0+1}(t) \leq y_{n_0+1}(t) \quad \text{for } t \in [0, 1]. \tag{2.84}$$

Next we show

$$y_{n_0+1}(t) \leq y_{n_0}(t) \quad \text{for } t \in [0, 1]. \tag{2.85}$$

If (2.85) is not true then $y_{n_0+1} - y_{n_0}$ would have a positive absolute maximum at say $\tau_0 \in (0, 1)$, in which case

$$(y_{n_0+1} - y_{n_0})'(\tau_0) = 0 \quad \text{and} \quad (y_{n_0+1} - y_{n_0})''(\tau_0) \leq 0.$$

Then $y_{n_0+1}(\tau_0) > y_{n_0}(\tau_0)$ together with $g_{n_0}(\tau_0, x) \geq g_{n_0+1}(\tau_0, x)$ for $x \in (0, \infty)$ gives

$$\begin{aligned} & (y_{n_0+1} - y_{n_0})''(\tau_0) \\ &= -q(\tau_0)[g_{n_0+1}(\tau_0, y_{n_0}(\tau_0)) + r(y_{n_0}(\tau_0) - y_{n_0+1}(\tau_0))] - y_{n_0}''(\tau_0) \\ &\geq -q(\tau_0)[g_{n_0}(\tau_0, y_{n_0}(\tau_0)) + r(y_{n_0}(\tau_0) - y_{n_0+1}(\tau_0))] - y_{n_0}''(\tau_0) \\ &= -q(\tau_0)[r(y_{n_0}(\tau_0) - y_{n_0+1}(\tau_0))] \\ &> 0, \end{aligned}$$

a contradiction.

Now proceed inductively to construct $y_{n_0+2}, y_{n_0+3}, \dots$ as follows. Suppose we have y_k for some $k \in \{n_0 + 1, n_0 + 2, \dots\}$ with $\alpha_k(t) \leq y_k(t) \leq y_{k-1}(t)$ for $t \in [0, 1]$. Then consider the boundary value problem

$$\begin{cases} y'' + q(t)g_{k+1}^*(t, y) = 0, & 0 < t < 1, \\ y(0) = y(1) = \rho_{k+1}; \end{cases} \quad (2.86)$$

here

$$g_{k+1}^*(t, y) = \begin{cases} g_{k+1}(t, \alpha_{k+1}(t)) + r(\alpha_{k+1}(t) - y), & y \leq \alpha_{k+1}(t), \\ g_{k+1}(t, y), & \alpha_{k+1}(t) \leq y \leq y_k(t), \\ g_{k+1}(t, y_k(t)) + r(y_k(t) - y), & y \geq y_k(t). \end{cases}$$

Now Schauder's fixed point theorem guarantees that (2.86) has a solution $y_{k+1} \in C[0, 1] \cap C^2(0, 1)$, and essentially the same reasoning as above yields

$$\alpha(t) \leq \alpha_{k+1}(t) \leq y_{k+1}(t) \leq y_k(t) \quad \text{for } t \in [0, 1]. \quad (2.87)$$

Thus for each $n \in \{n_0 + 1, \dots\}$ we have

$$\alpha(t) \leq y_n(t) \leq y_{n-1}(t) \leq \dots \leq y_{n_0}(t) \leq \beta(t) \quad \text{for } t \in [0, 1]. \quad (2.88)$$

Lets look at the interval $[\frac{1}{2^{n_0+1}}, 1 - \frac{1}{2^{n_0+1}}]$. Let

$$R_{n_0} = \sup \left\{ |q(x)f(x, y)| : x \in \left[\frac{1}{2^{n_0+1}}, 1 - \frac{1}{2^{n_0+1}} \right] \text{ and } \alpha(x) \leq y \leq y_{n_0}(x) \right\}.$$

The mean value theorem implies that there exists $\tau \in (\frac{1}{2^{n_0+1}}, 1 - \frac{1}{2^{n_0+1}})$ with $|y'_n(\tau)| \leq 2 \sup_{[0,1]} y_{n_0}(t)$. As a result

$$\left\{ \begin{array}{l} \{y_n\}_{n=n_0+1}^\infty \text{ is a bounded, equicontinuous} \\ \text{family on } [\frac{1}{2^{n_0+1}}, 1 - \frac{1}{2^{n_0+1}}]. \end{array} \right. \tag{2.89}$$

The Arzela–Ascoli theorem guarantees the existence of a subsequence N_{n_0} of integers and a function $z_{n_0} \in C[\frac{1}{2^{n_0+1}}, 1 - \frac{1}{2^{n_0+1}}]$ with y_n converging uniformly to z_{n_0} on $[\frac{1}{2^{n_0+1}}, 1 - \frac{1}{2^{n_0+1}}]$ as $n \rightarrow \infty$ through N_{n_0} . Similarly

$$\left\{ \begin{array}{l} \{y_n\}_{n=n_0+1}^\infty \text{ is a bounded, equicontinuous} \\ \text{family on } [\frac{1}{2^{n_0+2}}, 1 - \frac{1}{2^{n_0+2}}], \end{array} \right.$$

so there is a subsequence N_{n_0+1} of N_{n_0} and a function

$$z_{n_0+1} \in C\left[\frac{1}{2^{n_0+2}}, 1 - \frac{1}{2^{n_0+2}}\right]$$

with y_n converging uniformly to z_{n_0+1} on $[\frac{1}{2^{n_0+2}}, 1 - \frac{1}{2^{n_0+2}}]$ as $n \rightarrow \infty$ through N_{n_0+1} . Note $z_{n_0+1} = z_{n_0}$ on $[\frac{1}{2^{n_0+1}}, 1 - \frac{1}{2^{n_0+1}}]$ since $N_{n_0+1} \subseteq N_{n_0}$. Proceed inductively to obtain subsequences of integers

$$N_{n_0} \supseteq N_{n_0+1} \supseteq \dots \supseteq N_k \supseteq \dots$$

and functions

$$z_k \in C\left[\frac{1}{2^{k+1}}, 1 - \frac{1}{2^{k+1}}\right]$$

with

$$y_n \text{ converging uniformly to } z_k \text{ on } \left[\frac{1}{2^{k+1}}, 1 - \frac{1}{2^{k+1}}\right]$$

as $n \rightarrow \infty$ through N_k , and

$$z_k = z_{k-1} \quad \text{on } \left[\frac{1}{2^k}, 1 - \frac{1}{2^k}\right].$$

Define a function $y : [0, 1] \rightarrow [0, \infty)$ by $y(x) = z_k(x)$ on $[\frac{1}{2^{k+1}}, 1 - \frac{1}{2^{k+1}}]$ and $y(0) = y(1) = 0$. Notice y is well defined and $\alpha(t) \leq y(t) \leq y_{n_0}(t) (\leq \beta(t))$ for $t \in (0, 1)$. Next fix $t \in (0, 1)$ (without loss of generality assume $t \neq \frac{1}{2}$) and let $m \in \{n_0, n_0 + 1, \dots\}$ be

such that $\frac{1}{2^{m+1}} < t < 1 - \frac{1}{2^{m+1}}$. Let $N_m^* = \{n \in N_m : n \geq m\}$. Now $y_n, n \in N_m^*$, satisfies the integral equation

$$\begin{aligned} y_n(x) &= y_n\left(\frac{1}{2}\right) + y_n'\left(\frac{1}{2}\right)\left(x - \frac{1}{2}\right) + \int_{\frac{1}{2}}^x (s-x)q(s)g_n^*(s, y_n(s)) ds \\ &= y_n\left(\frac{1}{2}\right) + y_n'\left(\frac{1}{2}\right)\left(x - \frac{1}{2}\right) + \int_{\frac{1}{2}}^x (s-x)q(s)f(s, y_n(s)) ds \end{aligned}$$

for $x \in [\frac{1}{2^{m+1}}, 1 - \frac{1}{2^{m+1}}]$. Notice (take $x = \frac{2}{3}$ say) that $\{y_n'(\frac{1}{2})\}, n \in N_m^*$, is a bounded sequence since $\alpha(s) \leq y_n(s) \leq y_{n_0}(s) (\leq \beta(s))$ for $s \in [0, 1]$. Thus $\{y_n'(\frac{1}{2})\}_{n \in N_m^*}$ has a convergent subsequence; for convenience we will let $\{y_n'(\frac{1}{2})\}_{n \in N_m^*}$ denote this subsequence also and let $r \in \mathbf{R}$ be its limit. Now for the above fixed t ,

$$y_n(t) = y_n\left(\frac{1}{2}\right) + y_n'\left(\frac{1}{2}\right)\left(t - \frac{1}{2}\right) + \int_{\frac{1}{2}}^t (s-t)q(s)f(s, y_n(s)) ds$$

and let $n \rightarrow \infty$ through N_m^* to obtain

$$z_m(t) = z_m\left(\frac{1}{2}\right) + r\left(t - \frac{1}{2}\right) + \int_{\frac{1}{2}}^t (s-t)q(s)f(s, z_m(s)) ds,$$

i.e.,

$$y(t) = y\left(\frac{1}{2}\right) + r\left(t - \frac{1}{2}\right) + \int_{\frac{1}{2}}^t (s-t)q(s)f(s, y(s)) ds.$$

We can do this argument for each $t \in (0, 1)$ and so $y''(t) + q(t)f(t, y(t)) = 0$ for $t \in (0, 1)$. It remains to show y is continuous at 0 and 1.

Let $\varepsilon > 0$ be given. Now since $\lim_{n \rightarrow \infty} y_n(0) = 0$ there exists $n_1 \in \{n_0, n_0 + 1, \dots\}$ with $y_{n_1}(0) < \frac{\varepsilon}{2}$. Since $y_{n_1} \in C[0, 1]$ there exists $\delta_{n_1} > 0$ with

$$y_{n_1}(t) < \frac{\varepsilon}{2} \quad \text{for } t \in [0, \delta_{n_1}].$$

Now for $n \geq n_1$ we have, since $\{y_n(t)\}$ is nonincreasing for each $t \in [0, 1]$,

$$\alpha(t) \leq y_n(t) \leq y_{n_1}(t) < \frac{\varepsilon}{2} \quad \text{for } t \in [0, \delta_{n_1}].$$

Consequently

$$\alpha(t) \leq y(t) \leq \frac{\varepsilon}{2} < \varepsilon \quad \text{for } t \in (0, \delta_{n_1}]$$

and so y is continuous at 0. Similarly y is continuous at 1. As a result $y \in C[0, 1]$. \square

Suppose (2.71)–(2.74) hold and in addition assume the following conditions are satisfied:

$$q(t)f(t, y) + \alpha''(t) > 0 \quad \text{for } (t, y) \in (0, 1) \times \{y \in (0, \infty): y < \alpha(t)\} \quad (2.90)$$

and

$$\left\{ \begin{array}{l} \text{there exists a function } \beta \in C[0, 1] \cap C^2(0, 1) \\ \text{with } \beta(t) \geq \rho_{n_0} \text{ for } t \in [0, 1] \text{ and with} \\ q(t)f(t, \beta(t)) + \beta''(t) \leq 0 \text{ for } t \in (0, 1) \text{ and} \\ q(t)f\left(\frac{1}{2^{n_0+1}}, \beta(t)\right) + \beta''(t) \leq 0 \text{ for } t \in \left(0, \frac{1}{2^{n_0+1}}\right). \end{array} \right. \quad (2.91)$$

Then the result in Theorem 2.9 is again true. This follows immediately from Theorem 2.9 once we show (2.75) holds, i.e., once we show $\beta(t) \geq \alpha(t)$ for $t \in [0, 1]$. Suppose it is false. Then $\alpha - \beta$ would have a positive absolute maximum at say $\tau_0 \in (0, 1)$, so $(\alpha - \beta)'(\tau_0) = 0$ and $(\alpha - \beta)''(\tau_0) \leq 0$. Now $\alpha(\tau_0) > \beta(\tau_0)$ and (2.90) implies

$$q(\tau_0)f(\tau_0, \beta(\tau_0)) + \alpha''(\tau_0) > 0.$$

This together with (2.91) yields

$$(\alpha - \beta)''(\tau_0) = \alpha''(\tau_0) - \beta''(\tau_0) \geq \alpha''(\tau_0) + q(\tau_0)f(\tau_0, \beta(\tau_0)) > 0,$$

a contradiction. Thus we have

COROLLARY 2.10. *Let $n_0 \in \{1, 2, \dots\}$ be fixed and suppose (2.71)–(2.74), (2.90) and (2.91) hold. Then (2.62) has a solution $y \in C[0, 1] \cap C^2(0, 1)$ with $y(t) \geq \alpha(t)$ for $t \in [0, 1]$.*

REMARK 2.9. If in (2.72) we replace $\frac{1}{2^{n+1}} \leq t \leq 1$ with $0 \leq t \leq 1 - \frac{1}{2^{n+1}}$ then one would replace (2.75) with

$$\left\{ \begin{array}{l} \text{there exists a function } \beta \in C[0, 1] \cap C^2(0, 1) \\ \text{with } \beta(t) \geq \alpha(t) \text{ and } \beta(t) \geq \rho_{n_0} \text{ for } t \in [0, 1] \\ \text{with } q(t)f(t, \beta(t)) + \beta''(t) \leq 0 \text{ for } t \in (0, 1) \text{ and} \\ q(t)f\left(1 - \frac{1}{2^{n_0+1}}, \beta(t)\right) + \beta''(t) \leq 0 \text{ for } t \in \left(1 - \frac{1}{2^{n_0+1}}, 1\right). \end{array} \right. \quad (2.92)$$

If in (2.72) we replace $\frac{1}{2^{n+1}} \leq t \leq 1$ with $\frac{1}{2^{n+1}} \leq t \leq 1 - \frac{1}{2^{n+1}}$ then essentially the same reasoning as in Theorem 2.9 establishes the following results.

THEOREM 2.11. *Let $n_0 \in \{1, 2, \dots\}$ be fixed and suppose (2.71), (2.73), (2.74) and the following hold:*

$$\left\{ \begin{array}{l} \text{let } n \in \{n_0, n_0 + 1, \dots\} \text{ and associated with each } n \text{ we} \\ \text{have a constant } \rho_n \text{ such that } \{\rho_n\} \text{ is a nonincreasing} \\ \text{sequence with } \lim_{n \rightarrow \infty} \rho_n = 0 \text{ and such that for} \\ \frac{1}{2^{n+1}} \leq t \leq 1 - \frac{1}{2^{n+1}} \text{ we have } q(t)f(t, \rho_n) \geq 0 \end{array} \right. \quad (2.93)$$

and

$$\left\{ \begin{array}{l} \text{there exists a function } \beta \in C[0, 1] \cap C^2(0, 1) \\ \text{with } \beta(t) \geq \alpha(t) \text{ and } \beta(t) \geq \rho_{n_0} \text{ for } t \in [0, 1] \\ \text{with } q(t)f(t, \beta(t)) + \beta''(t) \leq 0 \text{ for } t \in (0, 1) \text{ and} \\ q(t)f\left(\frac{1}{2^{n_0+1}}, \beta(t)\right) + \beta''(t) \leq 0 \text{ for } t \in \left(0, \frac{1}{2^{n_0+1}}\right) \text{ and} \\ q(t)f\left(1 - \frac{1}{2^{n_0+1}}, \beta(t)\right) + \beta''(t) \leq 0 \text{ for } t \in \left(1 - \frac{1}{2^{n_0+1}}, 1\right). \end{array} \right. \quad (2.94)$$

Then (2.62) has a solution $y \in C[0, 1] \cap C^2(0, 1)$ with $y(t) \geq \alpha(t)$ for $t \in [0, 1]$.

PROOF. In this case let

$$e_n = \left[\frac{1}{2^{n+1}}, 1 - \frac{1}{2^{n+1}} \right] \quad \text{and} \quad \theta_n(t) = \max \left\{ \frac{1}{2^{n+1}}, \min \left\{ t, 1 - \frac{1}{2^{n+1}} \right\} \right\}.$$

□

COROLLARY 2.12. Let $n_0 \in \{1, 2, \dots\}$ be fixed and suppose (2.71), (2.73), (2.74), (2.90), (2.93) and the following hold:

$$\left\{ \begin{array}{l} \text{there exists a function } \beta \in C[0, 1] \cap C^2(0, 1) \\ \text{with } \beta(t) \geq \rho_{n_0} \text{ for } t \in [0, 1] \text{ and with} \\ q(t)f(t, \beta(t)) + \beta''(t) \leq 0 \text{ for } t \in (0, 1) \text{ and} \\ q(t)f\left(\frac{1}{2^{n_0+1}}, \beta(t)\right) + \beta''(t) \leq 0 \text{ for } t \in \left(0, \frac{1}{2^{n_0+1}}\right) \text{ and} \\ q(t)f\left(1 - \frac{1}{2^{n_0+1}}, \beta(t)\right) + \beta''(t) \leq 0 \text{ for } t \in \left(1 - \frac{1}{2^{n_0+1}}, 1\right). \end{array} \right. \quad (2.95)$$

Then (2.62) has a solution $y \in C[0, 1] \cap C^2(0, 1)$ with $y(t) \geq \alpha(t)$ for $t \in [0, 1]$.

Next we discuss how to construct the lower solution α in (2.74) and (2.90). Suppose the following condition is satisfied:

$$\left\{ \begin{array}{l} \text{let } n \in \{n_0, n_0 + 1, \dots\} \text{ and associated with each } n \text{ we} \\ \text{have a constant } \rho_n \text{ such that } \{\rho_n\} \text{ is a decreasing} \\ \text{sequence with } \lim_{n \rightarrow \infty} \rho_n = 0 \text{ and there exists a} \\ \text{constant } k_0 > 0 \text{ such that for } \frac{1}{2^{n+1}} \leq t \leq 1 \\ \text{and } 0 < y \leq \rho_n \text{ we have } q(t)f(t, y) \geq k_0. \end{array} \right. \quad (2.96)$$

We will show if (2.96) holds then (2.74) (and of course (2.72)) and (2.90) are satisfied (we also note that $\frac{1}{2^{n+1}} \leq t \leq 1$ in (2.96) could be replaced by $0 \leq t \leq 1 - \frac{1}{2^{n+1}}$

(respectively $\frac{1}{2^{n+1}} \leq t \leq 1 - \frac{1}{2^{n+1}}$) and (2.74), (2.90) hold with $\frac{1}{2^{n+1}} \leq t \leq 1$ replaced by $0 \leq t \leq 1 - \frac{1}{2^{n+1}}$ (respectively $\frac{1}{2^{n+1}} \leq t \leq 1 - \frac{1}{2^{n+1}}$)).

To show (2.74) and (2.90) recall the following well-known lemma.

LEMMA 2.13. *Let e_n be as described in Theorem 2.11 (or Theorem 2.9) and let $0 < \varepsilon_n < 1$ with $\varepsilon_n \downarrow 0$. Then there exists $\lambda \in C^2[0, 1]$ with $\sup_{[0,1]} |\lambda''(t)| > 0$ and $\lambda(0) = \lambda(1) = 0$ with*

$$0 < \lambda(t) \leq \varepsilon_n \quad \text{for } t \in e_n \setminus e_{n-1}, n \geq 1.$$

PROOF. Let $r : [0, 1] \rightarrow [0, \infty)$ be such that $r(0) = r(1) = 0$ and $r(t) = \varepsilon_n$ for all $t \in e_n \setminus e_{n-1}, n \geq 1$. Moreover, let

$$u(t) = \int_0^t r(s) ds, \quad v(t) = \int_0^t u(s) ds \quad \text{and} \quad w(t) = \int_0^t v(s) ds.$$

It is obvious that $u, v,$ and $w : [0, \frac{1}{2}] \rightarrow [0, \infty)$ are continuous and strictly increasing, with $w(\frac{1}{4}) < \varepsilon_1$.

Choose a natural number $k \geq 2$ with

$$\frac{(4k + 1)v(\frac{1}{4}) + 4v'(\frac{1}{4})}{16k(k + 1)} \leq \varepsilon_1 - w\left(\frac{1}{4}\right).$$

Let

$$\begin{aligned} c_0 &= \frac{4^{2k} [(2k - 1)v(\frac{1}{4}) + 4v'(\frac{1}{4})]}{k + 1}, \\ c_1 &= -\frac{4^{2(k-1)} [(2k - 1)v(\frac{1}{4}) + 4v'(\frac{1}{4})]}{k}, \\ c_2 &= w\left(\frac{1}{4}\right) + \frac{(4k + 1)v(\frac{1}{4}) + 4v'(\frac{1}{4})}{16k(k + 1)}, \end{aligned}$$

and

$$p(t) = c_0 \left(t - \frac{1}{2}\right)^{2(k+1)} + c_1 \left(t - \frac{1}{2}\right)^{2k} + c_2.$$

Define $\lambda : [0, 1] \rightarrow [0, \infty)$ as follows:

$$\lambda(t) = \begin{cases} w(t), & 0 \leq t \leq \frac{1}{4}, \\ p(t), & \frac{1}{4} \leq t \leq \frac{3}{4}, \\ w(1 - t), & \frac{3}{4} \leq t \leq 1. \end{cases}$$

Then λ satisfies the conditions of the lemma. □

Let $\varepsilon_n = \rho_n$ (and $n \geq n_0$) and let λ be as in Lemma 2.13. From (2.96) there exists $k_0 > 0$ with

$$q(t)f(t, y) \geq k_0 \quad \text{for } (t, y) \in (0, 1) \times \{y \in (0, \infty): y \leq \lambda(t)\} \quad (2.97)$$

since if $t \in e_n \setminus e_{n-1}$ ($n \geq n_0$) then $y \leq \lambda(t)$ implies $y \leq \rho_n$. Let

$$M = \sup_{[0,1]} |\lambda''(t)|, \quad m = \min \left\{ 1, \frac{k_0}{M+1} \right\} \quad \text{and} \quad \alpha(t) = m\lambda(t), \quad t \in [0, 1].$$

In particular since $\alpha(t) \leq \lambda(t)$ we have from (2.97) that

$$q(t)f(t, \alpha(t)) + \alpha''(t) \geq k_0 + \alpha''(t) \geq k_0 - \frac{k_0|\lambda''(t)|}{M+1} > 0$$

for $t \in (0, 1)$, and also

$$q(t)f(t, y) + \alpha''(t) \geq k_0 + \alpha''(t) > 0$$

for $(t, y) \in (0, 1) \times \{y \in (0, \infty): y \leq \alpha(t)\}$. Thus (2.74) and (2.90) hold.

THEOREM 2.14. *Let $n_0 \in \{1, 2, \dots\}$ be fixed and suppose (2.71), (2.73), (2.91) and (2.96) hold. Then (2.62) has a solution $y \in C[0, 1] \cap C^2(0, 1)$ with $y(t) > 0$ for $t \in (0, 1)$.*

If in (2.96) we replace $\frac{1}{2^{n+1}} \leq t \leq 1$ with $\frac{1}{2^{n+1}} \leq t \leq 1 - \frac{1}{2^{n+1}}$ then (2.74) and (2.90) also hold. We combine this with Corollary 2.12 to obtain our next result.

THEOREM 2.15. *Let $n_0 \in \{1, 2, \dots\}$ be fixed and suppose (2.71), (2.73), (2.95) and (2.96) (with $\frac{1}{2^{n+1}} \leq t \leq 1$ replaced by $\frac{1}{2^{n+1}} \leq t \leq 1 - \frac{1}{2^{n+1}}$) hold. Then (2.62) has a solution $y \in C[0, 1] \cap C^2(0, 1)$ with $y(t) > 0$ for $t \in (0, 1)$.*

Looking at Theorem 2.14 we see that the main difficulty when discussing examples is the construction of the β in (2.91). Our next result replaces (2.91) with a superlinear type condition. We first prove the result in its full generality.

THEOREM 2.16. *Let $n_0 \in \{1, 2, \dots\}$ be fixed and suppose (2.71)–(2.74) hold. Also assume the following two conditions are satisfied:*

$$\left\{ \begin{array}{l} |f(t, y)| \leq g(y) + h(y) \text{ on } [0, 1] \times (0, \infty) \text{ with} \\ g > 0 \text{ continuous and nonincreasing on } (0, \infty), \\ h \geq 0 \text{ continuous on } [0, \infty), \text{ and } \frac{h}{g} \\ \text{nondecreasing on } (0, \infty) \end{array} \right. \quad (2.98)$$

and

$$\left\{ \begin{array}{l} \text{for any } R > 0, \frac{1}{g} \text{ is differentiable on } (0, R] \text{ with} \\ g' < 0 \text{ a.e. on } (0, R] \text{ and } \frac{g'}{g^2} \in L^1[0, R]. \end{array} \right. \quad (2.99)$$

In addition suppose there exists $M > \sup_{t \in [0, 1]} \alpha(t)$ with

$$\frac{1}{\{1 + \frac{h(M)}{g(M)}\}} \int_0^M \frac{du}{g(u)} > b_0 \quad (2.100)$$

holding; here

$$b_0 = \max \left\{ 2 \int_0^{\frac{1}{2}} t(1-t)q(t) dt, 2 \int_{\frac{1}{2}}^1 t(1-t)q(t) dt \right\}.$$

Then (2.62) has a solution $y \in C[0, 1] \cap C^2(0, 1)$ with $y(t) \geq \alpha(t)$ for $t \in [0, 1]$.

PROOF. Fix $n \in \{n_0, n_0 + 1, \dots\}$. Choose $\varepsilon, 0 < \varepsilon < M$ with

$$\frac{1}{\{1 + \frac{h(M)}{g(M)}\}} \int_\varepsilon^M \frac{du}{g(u)} > b_0. \quad (2.101)$$

Let $m_0 \in \{1, 2, \dots\}$ be chosen so that $\rho_{m_0} < \varepsilon$ and without loss of generality assume $m_0 \leq n_0$. Let e_n, θ_n, f_n, g_n and α_n be as in Theorem 2.9. We consider the boundary value problem (2.76) with in this case $g_{n_0}^*$ given by

$$g_{n_0}^*(t, y) = \begin{cases} g_{n_0}(t, \alpha_{n_0}(t)) + r(\alpha_{n_0}(t) - y), & y \leq \alpha_{n_0}(t), \\ g_{n_0}(t, y), & \alpha_{n_0}(t) \leq y \leq M, \\ g_{n_0}(t, M) + r(M - y), & y \geq M. \end{cases}$$

Essentially the same reasoning as in Theorem 2.9 implies that (2.76) has a solution $y_{n_0} \in C[0, 1] \cap C^2(0, 1)$ with $y_{n_0}(t) \geq \alpha_{n_0}(t) \geq \alpha(t)$ for $t \in [0, 1]$. Next we show

$$y_{n_0}(t) \leq M \quad \text{for } t \in [0, 1]. \quad (2.102)$$

Suppose (2.102) is false. Now since $y_{n_0}(0) = y_{n_0}(1) = \rho_{n_0}$ there exists either

- (i) $t_1, t_2 \in (0, 1), t_2 < t_1$ with $\alpha_{n_0}(t) \leq y_{n_0}(t) \leq M$ for $t \in [0, t_2), y_{n_0}(t_2) = M$ and $y_{n_0}(t) > M$ on (t_2, t_1) with $y'_{n_0}(t_1) = 0$; or
- (ii) $t_3, t_4 \in (0, 1), t_4 < t_3$ with $\alpha_{n_0}(t) \leq y_{n_0}(t) \leq M$ for $t \in (t_3, 1], y_{n_0}(t_3) = M$ and $y_{n_0}(t) > M$ on (t_4, t_3) with $y'_{n_0}(t_4) = 0$.

We can assume without loss of generality that either $t_1 \leq \frac{1}{2}$ or $t_4 \geq \frac{1}{2}$. Suppose $t_1 \leq \frac{1}{2}$. Notice for $t \in (t_2, t_1)$ that we have

$$-y''_{n_0}(t) = q(t)g_{n_0}^*(t, y_{n_0}(t)) \leq q(t)[g(M) + h(M)]; \quad (2.103)$$

note for $t \in (t_2, t_1)$ that we have from (2.98),

$$g_{n_0}^*(t, y_{n_0}(t)) = g_{n_0}(t, M) + r(M - y_{n_0}(t)) \leq \max \left\{ f \left(\frac{1}{2^{n_0+1}}, M \right), f(t, M) \right\}.$$

Integrate (2.103) from t_2 to t_1 to obtain

$$y'_{n_0}(t_2) \leq [g(M) + h(M)] \int_{t_2}^{t_1} q(s) ds$$

and this together with $y_{n_0}(t_2) = M$ yields

$$\frac{y'_{n_0}(t_2)}{g(y_{n_0}(t_2))} \leq \left\{ 1 + \frac{h(M)}{g(M)} \right\} \int_{t_2}^{t_1} q(s) ds. \quad (2.104)$$

Also for $t \in (0, t_2)$ we have

$$\begin{aligned} -y''_{n_0}(t) &= q(t) \max \left\{ f \left(\frac{1}{2^{n_0+1}}, y_{n_0}(t) \right), f(t, y_{n_0}(t)) \right\} \\ &\leq q(t) [g(y_{n_0}(t)) + h(y_{n_0}(t))], \end{aligned}$$

and so

$$\frac{-y''_{n_0}(t)}{g(y_{n_0}(t))} \leq q(t) \left\{ 1 + \frac{h(y_{n_0}(t))}{g(y_{n_0}(t))} \right\} \leq q(t) \left\{ 1 + \frac{h(M)}{g(M)} \right\}$$

for $t \in (0, t_2)$. Integrate from t ($t \in (0, t_2)$) to t_2 to obtain

$$\begin{aligned} \frac{-y'_{n_0}(t_2)}{g(y_{n_0}(t_2))} + \frac{y'_{n_0}(t)}{g(y_{n_0}(t))} + \int_t^{t_2} \left\{ \frac{-g'(y_{n_0}(x))}{g^2(y_{n_0}(x))} \right\} [y'_{n_0}(x)]^2 dx \\ \leq \left\{ 1 + \frac{h(M)}{g(M)} \right\} \int_t^{t_2} q(x) dx, \end{aligned}$$

and this together with (2.104) (and (2.99)) yields

$$\frac{y'_{n_0}(t)}{g(y_{n_0}(t))} \leq \left\{ 1 + \frac{h(M)}{g(M)} \right\} \int_t^{t_1} q(x) dx \quad \text{for } t \in (0, t_2).$$

Integrate from 0 to t_2 to obtain

$$\int_{\varepsilon}^M \frac{du}{g(u)} \leq \int_{\rho_{n_0}}^M \frac{du}{g(u)} \leq \left\{ 1 + \frac{h(M)}{g(M)} \right\} \frac{1}{1-t_1} \int_0^{t_1} x(1-x)q(x) dx.$$

That is

$$\int_{\varepsilon}^M \frac{du}{g(u)} \leq \left\{ 1 + \frac{h(M)}{g(M)} \right\} 2 \int_0^{\frac{1}{2}} x(1-x)q(x) dx \leq b_0 \left\{ 1 + \frac{h(M)}{g(M)} \right\}.$$

This contradicts (2.101) so (2.102) holds (a similar argument yields a contradiction if $t_4 \geq \frac{1}{2}$). Thus we have

$$\alpha(t) \leq \alpha_{n_0}(t) \leq y_{n_0}(t) \leq M \quad \text{for } t \in [0, 1].$$

Essentially the same reasoning as in Theorem 2.9 (from (2.82) onwards) completes the proof. \square

Similarly we have the following result.

THEOREM 2.17. *Let $n_0 \in \{1, 2, \dots\}$ be fixed and suppose (2.71), (2.73), (2.74), (2.93), (2.98) and (2.99) hold. In addition assume there exists*

$$M > \sup_{t \in [0, 1]} \alpha(t)$$

with (2.100) holding. Then (2.62) has a solution $y \in C[0, 1] \cap C^2(0, 1)$ with $y(t) \geq \alpha(t)$ for $t \in [0, 1]$.

COROLLARY 2.18. *Let $n_0 \in \{1, 2, \dots\}$ be fixed and suppose (2.71)–(2.74), (2.90), (2.98) and (2.99) hold. In addition assume there is a constant $M > 0$ with*

$$\frac{1}{\left\{ 1 + \frac{h(M)}{g(M)} \right\}} \int_0^M \frac{du}{g(u)} > b_0 \tag{2.105}$$

holding; here

$$b_0 = \max \left\{ 2 \int_0^{\frac{1}{2}} t(1-t)q(t) dt, 2 \int_{\frac{1}{2}}^1 t(1-t)q(t) dt \right\}.$$

Then (2.62) has a solution $y \in C[0, 1] \cap C^2(0, 1)$ with $y(t) \geq \alpha(t)$ for $t \in [0, 1]$.

PROOF. The result follows immediately from Theorem 2.16 once we show $\alpha(t) \leq M$ for $t \in [0, 1]$. Suppose this is false. Now since $\alpha(0) = \alpha(1) = 0$ there exists either

- (i) $t_1, t_2 \in (0, 1)$, $t_2 < t_1$ with $0 \leq \alpha(t) \leq M$ for $t \in [0, t_2)$, $\alpha(t_2) = M$ and $\alpha(t) > M$ on (t_2, t_1) with $\alpha'(t_1) = 0$; or
- (ii) $t_3, t_4 \in (0, 1)$, $t_4 < t_3$ with $0 \leq \alpha(t) \leq M$ for $t \in (t_3, 1]$, $\alpha(t_3) = M$ and $\alpha(t) > M$ on (t_4, t_3) with $\alpha'(t_4) = 0$.

We can assume without loss of generality that either $t_1 \leq \frac{1}{2}$ or $t_4 \geq \frac{1}{2}$. Suppose $t_1 \leq \frac{1}{2}$. Notice for $t \in (t_2, t_1)$ that we have from (2.90) and (2.98) that

$$-\alpha''(t) \leq q(t)[g(M) + h(M)]$$

so integration from t_2 to t_1 yields

$$\frac{\alpha'(t_2)}{g(\alpha(t_2))} \leq \left\{ 1 + \frac{h(M)}{g(M)} \right\} \int_{t_2}^{t_1} q(s) \, ds. \quad (2.106)$$

Also for $t \in (0, t_2)$ we have from (2.90) and (2.98) that

$$-\alpha''(t) \leq q(t)g(\alpha(t)) \left\{ 1 + \frac{h(\alpha(t))}{g(\alpha(t))} \right\} \leq q(t)g(\alpha(t)) \left\{ 1 + \frac{h(M)}{g(M)} \right\}.$$

Integrate from t ($t \in (0, t_2)$) to t_2 and use (2.106) to obtain

$$\frac{\alpha'(t)}{g(\alpha(t))} \leq \left\{ 1 + \frac{h(M)}{g(M)} \right\} \int_t^{t_1} q(s) \, ds \quad \text{for } t \in (0, t_2).$$

Finally integrate from 0 to t_2 to obtain

$$\int_0^M \frac{du}{g(u)} \leq b_0 \left\{ 1 + \frac{h(M)}{g(M)} \right\},$$

a contradiction. □

COROLLARY 2.19. *Let $n_0 \in \{1, 2, \dots\}$ be fixed and suppose (2.71), (2.73), (2.74), (2.90), (2.93), (2.98) and (2.99) hold. In addition assume there is a constant $M > 0$ with (2.105) holding. Then (2.62) has a solution $y \in C[0, 1] \cap C^2(0, 1)$ with $y(t) \geq \alpha(t)$ for $t \in [0, 1]$.*

Combining Corollary 2.18 with the comments before Theorem 2.14 yields the following theorem.

THEOREM 2.20. *Let $n_0 \in \{1, 2, \dots\}$ be fixed and suppose (2.71), (2.73), (2.96), (2.98) and (2.99) hold. In addition assume there exists $M > 0$ with (2.105) holding. Then (2.62) has a solution $y \in C[0, 1] \cap C^2(0, 1)$ with $y(t) > 0$ for $t \in (0, 1)$.*

Similarly combining Corollary 2.19 with the comments before Theorem 2.14 yields the following theorem.

THEOREM 2.21. *Let $n_0 \in \{1, 2, \dots\}$ be fixed and suppose (2.71), (2.73), (2.96) (with $\frac{1}{2^{n+1}} \leq t \leq 1$ replaced by $\frac{1}{2^{n+1}} \leq t \leq 1 - \frac{1}{2^{n+1}}$), (2.98) and (2.99) hold. In addition assume there exists $M > 0$ with (2.105) holding. Then (2.62) has a solution $y \in C[0, 1] \cap C^2(0, 1)$ with $y(t) > 0$ for $t \in (0, 1)$.*

Next we present some examples which illustrate how easily the theory is applied in practice.

EXAMPLE 2.2. Consider the boundary value problem

$$\begin{cases} y'' + (At^\gamma y^{-\theta} - \mu^2) = 0, & 0 < t < 1, \\ y(0) = y(1) = 0 \end{cases} \quad (2.107)$$

with $A > 0$, $\theta > 0$, $\gamma > -2$ and $\mu \in \mathbf{R}$. Then (2.107) has a solution $y \in C[0, 1] \cap C^2(0, 1)$ with $y(t) > 0$ for $t \in (0, 1)$.

To see this we will apply Theorem 2.20. We will consider two cases, namely $\gamma \geq 0$ and $-2 < \gamma < 0$.

Case (i). $\gamma \geq 0$.

We will apply Theorem 2.20 with

$$q(t) = 1, \quad g(y) = Ay^{-\theta} \quad \text{and} \quad h(y) = \mu^2.$$

Clearly (2.71), (2.73), (2.98) and (2.99) hold. Let

$$n_0 = 1, \quad \rho_n = \left(\frac{A}{2^{(n+1)\gamma}(\mu^2 + 1)} \right)^{1/\theta} \quad \text{and} \quad k_0 = 1.$$

Notice for $n \in \{1, 2, \dots\}$, $\frac{1}{2^{n+1}} \leq t \leq 1$ and $0 < y \leq \rho_n$ that we have

$$q(t)f(t, y) \geq \frac{A}{2^{(n+1)\gamma} \rho_n^\theta} - \mu^2 = (\mu^2 + 1) - \mu^2 = 1,$$

so (2.96) is satisfied. Finally notice for $c > 0$ that

$$\frac{1}{\{1 + \frac{h(c)}{g(c)}\}} \int_0^c \frac{du}{g(u)} = \frac{1}{\theta + 1} \frac{c^{\theta+1}}{A + \mu^2 c^\theta},$$

so

$$\lim_{c \rightarrow \infty} \frac{1}{\{1 + \frac{h(c)}{g(c)}\}} \int_0^c \frac{du}{g(u)} = \infty.$$

Thus there exists $M > 0$ with (2.105) holding. Existence of a solution is now guaranteed from Theorem 2.20.

Case (ii). $-2 < \gamma < 0$.

We will apply Theorem 2.20 with

$$q(t) = t^\gamma, \quad g(y) = Ay^{-\theta} \quad \text{and} \quad h(y) = \mu^2.$$

Clearly (2.71), (2.73), (2.98) and (2.99) hold. Also as in Case (i) there exists $M > 0$ with (2.105) holding. Let

$$n_0 = 1, \quad \rho_n = \left(\frac{A}{n(\mu^2 + 1)} \right)^{1/\theta} \quad \text{and} \quad k_0 = 1.$$

Notice for $n \in \{1, 2, \dots\}$, $\frac{1}{2^{n+1}} \leq t \leq 1$ and $0 < y \leq \rho_n$ that we have since $\gamma < 0$,

$$q(t)f(t, y) \geq \frac{At^\gamma}{\rho_n^\theta} - \mu^2 \geq \frac{A}{\rho_n^\theta} - \mu^2 = n(\mu^2 + 1) - \mu^2 \geq (\mu^2 + 1) - \mu^2 = 1.$$

Thus (2.96) is satisfied. Existence of a solution is now guaranteed from Theorem 2.20.

EXAMPLE 2.3. Consider the boundary value problem

$$\begin{cases} y'' + \left(\frac{t}{y^2} + \frac{1}{32}y^2 - \mu^2 \right) = 0, & 0 < t < 1, \\ y(0) = y(1) = 0, \end{cases} \quad (2.108)$$

where $\mu^2 \geq 1$. Then (2.108) has a solution $y \in C[0, 1] \cap C^2(0, 1)$ with $y(t) > 0$ for $t \in (0, 1)$.

To see that (2.108) has the desired solution we will apply Theorem 2.14 with

$$q \equiv 1, \quad \rho_n = \left(\frac{1}{2^{n+1}(\mu^2 + a)} \right)^{\frac{1}{2}} \quad \text{and} \quad k_0 = a;$$

here $a > 0$ is chosen so that $a \leq \frac{1}{8}$. Also we choose $n_0 \in \{1, 2, \dots\}$ with $\rho_{n_0} \leq 1$. Clearly (2.71) and (2.73) hold. Notice for $n \in \{1, 2, \dots\}$, $\frac{1}{2^{n+1}} \leq t \leq 1$ and $0 < y \leq \rho_n$ that we have

$$q(t)f(t, y) \geq \frac{t}{y^2} - \mu^2 \geq \frac{1}{2^{n+1}\rho_n^2} - \mu^2 = (\mu^2 + a) - \mu^2 = a,$$

so (2.96) is satisfied. It remains to check (2.91) with

$$\beta(t) = \sqrt{t} + \rho_{n_0}.$$

Now $\beta''(t) = -\frac{1}{4}t^{-\frac{3}{2}}$ and so for $t \in (0, 1)$ we have

$$\begin{aligned} \beta''(t) + q(t)f(t, \beta(t)) &\leq -\frac{1}{4} \frac{1}{t^{\frac{3}{2}}} + \left(\frac{t}{t} + \frac{(\sqrt{t} + \rho_{n_0})^2}{32} - \mu^2 \right) \\ &\leq -\frac{1}{4} + \left(1 + \frac{1}{8} - \mu^2 \right) \leq 0. \end{aligned}$$

Also for $t \in (0, \frac{1}{2^{n_0+1}})$ we have

$$\begin{aligned} \beta''(t) + q(t)f(t, \beta(t)) &\leq -\frac{1}{4} \frac{1}{t^{\frac{3}{2}}} + \left(\frac{1}{2^{n_0+1} \rho_{n_0}^2} + \frac{(\sqrt{t} + \rho_{n_0})^2}{32} - \mu^2 \right) \\ &\leq -\frac{1}{4} + \left((\mu^2 + a) + \frac{1}{8} - \mu^2 \right) \\ &= a - \frac{1}{8} \leq 0. \end{aligned}$$

As a result (2.91) holds so existence is now guaranteed from Theorem 2.14.

In the literature nonresonant results [19] have been presented for nonsingular Dirichlet problems, i.e., for (1.2) when qf is a Carathéodory function. Next, by combining some of the ideas in [19] with those above, we present a nonresonant theory for the singular problem (2.62). It is worth remarking here that we could consider Sturm Liouville boundary data in (2.62); however since the arguments are essentially the same (in fact easier) we will restrict our discussion to Dirichlet boundary data.

The results here rely on the following well-known Rayleigh–Ritz inequality.

THEOREM 2.22. *Suppose $q \in C(0, 1) \cap L^1[0, 1]$ with $q > 0$ on $(0, 1)$. Let λ_1 be the first eigenvalue of*

$$\begin{cases} y'' + \lambda qy = 0, & 0 < t < 1, \\ y(0) = 0 = y(1). \end{cases} \tag{2.109}$$

Then

$$\lambda_1 \int_0^1 q(t)|v(t)|^2 dt \leq \int_0^1 |v'(t)|^2 dt$$

for all functions $v \in AC[0, 1]$ with $v' \in L^2[0, 1]$ and $v(0) = v(1) = 0$.

For notational purposes in our next theorem, for appropriate functions u we let

$$\|u\|_2 = \left(\int_0^1 |u(t)|^2 dt \right)^{\frac{1}{2}}, \quad |u|_\infty = \sup_{[0,1]} |u(t)| \quad \text{and} \quad \|u\|_1 = \int_0^1 |u(t)| dt.$$

We begin with our main result (in fact a more general result will be presented at the end of this section; see Theorem 2.26)).

THEOREM 2.23. *Let $n_0 \in \{1, 2, \dots\}$ be fixed and suppose (2.72) and (2.74) hold. In addition assume the following conditions are satisfied:*

$$f : (0, 1) \times (0, \infty) \rightarrow \mathbf{R} \text{ is continuous} \quad (2.110)$$

$$q \in C(0, 1) \cap L^1[0, 1] \text{ with } q > 0 \text{ on } (0, 1) \quad (2.111)$$

and

$$\begin{cases} \text{for any } \varepsilon > 0, \exists a_0 \geq 0 \text{ with } a_0 < \lambda_1, b_0 \geq 0, 0 \leq \gamma < 1, \\ h_\varepsilon \in L^1_q[0, 1] \text{ with } h_\varepsilon \geq 0 \text{ a.e. on } (0, 1) \text{ with} \\ |f(t, u)| \leq a_0 u + b_0 u^\gamma + h_\varepsilon(t) \text{ for } t \in (0, 1) \text{ and } u \geq \varepsilon; \end{cases} \quad (2.112)$$

here λ_1 is the first eigenvalue of (2.109). Then (2.62) has a solution $y \in C[0, 1] \cap C^2(0, 1)$ with $y(t) \geq \alpha(t)$ for $t \in [0, 1]$.

PROOF. For $n = n_0, n_0 + 1, \dots$ let e_n, θ_n, f_n and g_n be as in Theorem 2.9. Without loss of generality assume $\rho_{n_0} \leq \min_{t \in [\frac{1}{3}, \frac{2}{3}]} \alpha(t)$. Fix $n \in \{n_0, n_0 + 1, \dots\}$. Let $t_n \in [0, \frac{1}{3}]$ and $s_n \in [\frac{2}{3}, 1]$ be such that

$$\alpha(t_n) = \alpha(s_n) = \rho_n \quad \text{and} \quad \alpha(t) \leq \rho_n \quad \text{for } t \in [0, t_n] \cup [s_n, 1].$$

Define

$$\alpha_n(t) = \begin{cases} \rho_n & \text{if } t \in [0, t_n] \cup [s_n, 1], \\ \alpha(t) & \text{if } t \in (t_n, s_n). \end{cases}$$

We begin with the boundary value problem

$$\begin{cases} y'' + q(t)g_{n_0}^*(t, y) = 0, & 0 < t < 1, \\ y(0) = y(1) = \rho_{n_0}; \end{cases} \quad (2.113)$$

here

$$g_{n_0}^*(t, y) = \begin{cases} g_{n_0}(t, \alpha_{n_0}(t)) + r(\alpha_{n_0}(t) - y), & y \leq \alpha_{n_0}(t), \\ g_{n_0}(t, y), & \alpha_{n_0}(t) \leq y \leq M, \\ g_{n_0}(t, M) + r(M - y), & y \geq M, \end{cases}$$

with $r : \mathbf{R} \rightarrow [-1, 1]$ the radial retraction defined by

$$r(u) = \begin{cases} u, & |u| \leq 1, \\ \frac{u}{|u|}, & |u| > 1, \end{cases}$$

and $M (\geq \sup_{[0,1]} \alpha_{n_0}(t))$ is a predetermined constant (see (2.117)). From Schauder's fixed point theorem we know that (2.113) has a solution $y_{n_0} \in C^1[0, 1] \cap C^2(0, 1)$ (notice from (2.112) that for any constants $r_1 > 0, r_2 > r_1, \exists h_{r_1, r_2} \in L^1_q[0, 1]$ with $|f(t, u)| \leq h_{r_1, r_2}(t)$ for $t \in (0, 1)$ and $r_1 \leq u \leq r_2$). Exactly the same analysis as in Theorem 2.9 guarantees that

$$y_{n_0}(t) \geq \alpha_{n_0}(t), \quad t \in [0, 1], \quad (2.114)$$

and so

$$\alpha(t) \leq \alpha_{n_0}(t) \leq y_{n_0}(t) \quad \text{for } t \in [0, 1]. \quad (2.115)$$

Next we show

$$y_{n_0}(t) \leq M \quad \text{for } t \in [0, 1]. \quad (2.116)$$

Now (2.112) (with $\varepsilon = \min_{[0,1]} \alpha_{n_0}(t)$) and the definition of $g_{n_0}^*$ (of course with (2.114)) implies that there exists $h_\varepsilon \in L^1_q[0, 1]$ (with $h_\varepsilon \geq 0$ a.e. on $(0, 1)$) with (note $r : \mathbf{R} \rightarrow [-1, 1]$)

$$|g_{n_0}^*(t, y_{n_0}(t))| \leq a_0 y_{n_0}(t) + b_0 [y_{n_0}(t)]^\gamma + h(t) + 1 \quad \text{for } t \in (0, 1);$$

here $h(t) = \max\{h_\varepsilon(t), h_\varepsilon(\theta_{n_0}(t))\}$ (to see this fix $t \in (0, 1)$ and check the cases $y_{n_0}(t) \geq M$ and $\alpha_{n_0}(t) \leq y_{n_0}(t) \leq M$ separately).

Now let $v = y_{n_0} - \rho_{n_0}$. Then v satisfies

$$\begin{cases} v'' + q(t)g_{n_0}^*(t, v + \rho_{n_0}) = 0, & 0 < t < 1, \\ v(0) = v(1) = 0. \end{cases}$$

In addition since $-vv'' = qv g_{n_0}^*(t, v + \rho_{n_0})$ we have

$$\begin{aligned} (\|v'\|_2)^2 &= \int_0^1 q(t)v(t)g_{n_0}^*(t, v(t) + \rho_{n_0}) dt \\ &\leq \int_0^1 q(t)|v(t)||g_{n_0}^*(t, v(t) + \rho_{n_0})| dt \\ &\leq \int_0^1 q(t)|v(t)|[a_0(v(t) + \rho_{n_0}) + b_0(v(t) + \rho_{n_0})^\gamma + h(t) + 1] dt \\ &\leq a_0 \int_0^1 q|v|^2 dt + a_0 \rho_{n_0} \int_0^1 q|v| dt + 2^{\gamma-1} b_0 \int_0^1 q|v|^{\gamma+1} dt \\ &\quad + 2^{\gamma-1} b_0 \rho_{n_0}^\gamma \int_0^1 q|v| dt + \int_0^1 qh|v| dt + \int_0^1 q|v| dt. \end{aligned}$$

This together with Theorem 2.22 (and Hölder's inequality) yields

$$\begin{aligned} (\|v'\|_2)^2 &\leq \frac{a_0}{\lambda_1} (\|v'\|_2)^2 + \frac{a_0 \rho_{n_0}}{\sqrt{\lambda_1}} (\|q\|_1)^{\frac{1}{2}} \|v'\|_2 \\ &\quad + \frac{2^{\gamma-1} b_0}{\lambda_1^{\frac{\gamma+1}{2}}} (\|q\|_1)^{\frac{1-\gamma}{2}} (\|v'\|_2)^{\gamma+1} + \frac{2^{\gamma-1} b_0 \rho_{n_0}^\gamma}{\sqrt{\lambda_1}} (\|q\|_1)^{\frac{1}{2}} \|v'\|_2 \\ &\quad + \|qh\|_1 \|v\|_\infty + \frac{1}{\sqrt{\lambda_1}} (\|q\|_1)^{\frac{1}{2}} \|v'\|_2. \end{aligned}$$

Now since $v(0) = v(1) = 0$ it is easy to check that $|v|_\infty \leq \frac{1}{\sqrt{2}} \|v'\|_2$ and so

$$\begin{aligned} \left(1 - \frac{a_0}{\lambda_1}\right) (\|v'\|_2)^2 &\leq \frac{a_0 \rho_{n_0}}{\sqrt{\lambda_1}} (\|q\|_1)^{\frac{1}{2}} \|v'\|_2 + \frac{2^{\gamma-1} b_0}{\lambda_1^{\frac{\gamma+1}{2}}} (\|q\|_1)^{\frac{1-\gamma}{2}} (\|v'\|_2)^{\gamma+1} \\ &\quad + \frac{2^{\gamma-1} b_0 \rho_{n_0}^\gamma}{\sqrt{\lambda_1}} (\|q\|_1)^{\frac{1}{2}} \|v'\|_2 + \frac{\|qh\|_1}{\sqrt{2}} \|v'\|_2 \\ &\quad + \frac{1}{\sqrt{\lambda_1}} (\|q\|_1)^{\frac{1}{2}} \|v'\|_2. \end{aligned}$$

As a result, since $0 \leq \gamma < 1$, there exists a constant K_0 (chosen greater than or equal to $\sqrt{2} \sup_{[0,1]} \alpha_{n_0}(t)$) with $\|v'\|_2 \leq K_0$. This together with $|v|_\infty \leq \frac{1}{\sqrt{2}} \|v'\|_2$ yields $|v|_\infty \leq \frac{1}{\sqrt{2}} K_0$, and as a result

$$|y_{n_0}|_\infty \leq \frac{1}{\sqrt{2}} K_0 + \rho_{n_0} \equiv M. \tag{2.117}$$

Consequently (2.116) holds and so we have

$$\alpha(t) \leq \alpha_{n_0}(t) \leq y_{n_0}(t) \leq M \quad \text{for } t \in [0, 1].$$

Next we consider the boundary value problem

$$\begin{cases} y'' + q(t)g_{n_0+1}^*(t, y) = 0, & 0 < t < 1, \\ y(0) = y(1) = \rho_{n_0+1}; \end{cases} \tag{2.118}$$

here

$$g_{n_0+1}^*(t, y) = \begin{cases} g_{n_0+1}(t, \alpha_{n_0+1}(t)) + r(\alpha_{n_0+1}(t) - y), & y \leq \alpha_{n_0+1}(t), \\ g_{n_0+1}(t, y), & \alpha_{n_0+1}(t) \leq y \leq y_{n_0}(t), \\ g_{n_0+1}(t, y_{n_0}(t)) + r(y_{n_0}(t) - y), & y \geq y_{n_0}(t). \end{cases}$$

Schauder's fixed point theorem guarantees that (2.118) has a solution $y_{n_0+1} \in C^1[0, 1] \cap C^2(0, 1)$. Exactly the same analysis as in Theorem 2.9 guarantees

$$\alpha(t) \leq \alpha_{n_0+1}(t) \leq y_{n_0+1}(t) \leq y_{n_0}(t) \quad \text{for } t \in [0, 1]. \tag{2.119}$$

Now proceed inductively to construct $y_{n_0+2}, y_{n_0+3}, \dots$ as follows. Suppose we have y_k for some $k \in \{n_0 + 1, n_0 + 2, \dots\}$ with $\alpha_k(t) \leq y_k(t) \leq y_{k-1}(t)$ for $t \in [0, 1]$. Then consider the boundary value problem

$$\begin{cases} y'' + q(t)g_{k+1}^*(t, y) = 0, & 0 < t < 1, \\ y(0) = y(1) = \rho_{k+1}; \end{cases} \tag{2.120}$$

here

$$g_{k+1}^*(t, y) = \begin{cases} g_{k+1}(t, \alpha_{k+1}(t)) + r(\alpha_{k+1}(t) - y), & y \leq \alpha_{k+1}(t), \\ g_{k+1}(t, y), & \alpha_{k+1}(t) \leq y \leq y_k(t), \\ g_{k+1}(t, y_k(t)) + r(y_k(t) - y), & y \geq y_k(t). \end{cases}$$

Now Schauder's fixed point theorem guarantees that (2.120) has a solution $y_{k+1} \in C^1[0, 1] \cap C^2(0, 1)$, and essentially the same reasoning as in Theorem 2.9 yields

$$\alpha(t) \leq \alpha_{k+1}(t) \leq y_{k+1}(t) \leq y_k(t) \quad \text{for } t \in [0, 1].$$

Thus for each $n \in \{n_0 + 1, \dots\}$ we have

$$\alpha(t) \leq y_n(t) \leq y_{n-1}(t) \leq \dots \leq y_{n_0}(t) \leq M \quad \text{for } t \in [0, 1].$$

Essentially the same reasoning as in Theorem 2.9 (from (2.89) onwards) completes the proof. □

REMARK 2.10. In (2.72) it is possible to replace $\frac{1}{2^{n+1}} \leq t \leq 1$ with $0 \leq t \leq 1 - \frac{1}{2^{n+1}}$ or $\frac{1}{2^{n+1}} \leq t \leq 1 - \frac{1}{2^{n+1}}$ and the result in Theorem 2.23 is again true; the minor adjustments are left to the reader.

Next we discuss the lower solution α in (2.74). Suppose (2.96) holds. Then the argument before Theorem 2.14 guarantees that there exists a $\alpha \in C[0, 1] \cap C^2(0, 1)$, $\alpha(0) = \alpha(1) = 0$, $\alpha(t) \leq \rho_{n_0}$ for $t \in [0, 1]$ with (2.74) holding. Combine with Theorem 2.23 to obtain our next result.

THEOREM 2.24. *Let $n_0 \in \{1, 2, \dots\}$ be fixed and suppose (2.96), (2.110), (2.111) and (2.112) hold. Then (2.62) has a solution $y \in C[0, 1] \cap C^2(0, 1)$ with $y(t) > 0$ for $t \in (0, 1)$.*

If in (2.96) we replace $\frac{1}{2^{n+1}} \leq t \leq 1$ with $\frac{1}{2^{n+1}} \leq t \leq 1 - \frac{1}{2^{n+1}}$ then once again (2.74) holds.

THEOREM 2.25. *Let $n_0 \in \{1, 2, \dots\}$ be fixed and suppose (2.110), (2.111), (2.112) and (2.96) (with $\frac{1}{2^{n+1}} \leq t \leq 1$ replaced by $\frac{1}{2^{n+1}} \leq t \leq 1 - \frac{1}{2^{n+1}}$) hold. Then (2.62) has a solution $y \in C[0, 1] \cap C^2(0, 1)$ with $y(t) > 0$ for $t \in (0, 1)$.*

EXAMPLE 2.4. Consider the boundary value problem

$$\begin{cases} y'' + (At^\kappa y^{-\theta} + a_0 y + b_0 y^\gamma - \mu^2) = 0, & 0 < t < 1, \\ y(0) = y(1) = 0 \end{cases} \quad (2.121)$$

with $A > 0$, $\kappa > -1$, $\theta > 0$, $0 \leq \gamma < 1$, $0 \leq a_0 < \pi^2$, $b_0 \geq 0$ and $\mu \in \mathbf{R}$. Then (2.121) has a solution $y \in C[0, 1] \cap C^2(0, 1)$ with $y(t) > 0$ for $t \in (0, 1)$.

To see this we will apply Theorem 2.24 with

$$q = 1 \quad \text{and} \quad f(t, y) = At^\kappa y^{-\theta} + a_0y + b_0y^\gamma - \mu^2.$$

Clearly (2.110) and (2.111) hold. In addition (2.112) is immediate with $h_\varepsilon(t) = At^\kappa \varepsilon^{-\theta} + \mu^2$; note $\lambda_1 = \pi^2$. We will consider two cases, namely $\kappa \geq 0$ and $-1 < \kappa < 0$.

Case (i). $\kappa \geq 0$.

Let

$$n_0 = 1, \quad \rho_n = \left(\frac{A}{2^{(n+1)\kappa}(\mu^2 + 1)} \right)^{1/\theta} \quad \text{and} \quad k_0 = 1.$$

Notice for $n \in \{1, 2, \dots\}$, $\frac{1}{2^{n+1}} \leq t \leq 1$ and $0 < y \leq \rho_n$ that we have

$$q(t)f(t, y) \geq \frac{A}{2^{(n+1)\kappa}\rho_n^\theta} - \mu^2 = (\mu^2 + 1) - \mu^2 = 1,$$

so (2.96) holds.

Case (ii). $-1 < \kappa < 0$.

Let

$$n_0 = 1, \quad \rho_n = \left(\frac{A}{n(\mu^2 + 1)} \right)^{1/\theta} \quad \text{and} \quad k_0 = 1.$$

Notice for $n \in \{1, 2, \dots\}$, $\frac{1}{2^{n+1}} \leq t \leq 1$ and $0 < y \leq \rho_n$ that we have since $\kappa < 0$,

$$q(t)f(t, y) \geq \frac{At^\kappa}{\rho_n^\theta} - \mu^2 \geq \frac{A}{\rho_n^\theta} - \mu^2 = n(\mu^2 + 1) - \mu^2 \geq (\mu^2 + 1) - \mu^2 = 1,$$

so (2.96) holds.

Existence of a solution is now guaranteed from Theorem 2.24.

If one uses the ideas in [19, Chapter 11] it is possible to improve the result in Theorem 2.23.

THEOREM 2.26. *Let $n_0 \in \{1, 2, \dots\}$ be fixed and suppose (2.72), (2.74), (2.110) and (2.111) hold. In addition assume the following conditions are satisfied:*

$$\left\{ \begin{array}{l} \text{for any } \varepsilon > 0, \exists a_0 \in C[0, 1] \text{ with } 0 \leq a_0(t) \leq \lambda_1 \\ \text{on } [0, 1] \text{ and } a_0(t) < \lambda_1 \text{ on a subset of } [0, 1] \\ \text{of positive measure with } a_0\left(\frac{1}{2^{n_0+1}}\right) < \lambda_1, b_0 \geq 0, \\ 1 \leq \gamma < 2, h_\varepsilon \in L^1_q[0, 1] \text{ with } h_\varepsilon \geq 0 \text{ a.e. on } (0, 1) \\ \text{with } uf(t, u) \leq a_0(t)u^2 + b_0u^\gamma + uh_\varepsilon(t) \\ \text{for } t \in (0, 1) \text{ and } u \geq \varepsilon \end{array} \right. \quad (2.122)$$

and

$$\begin{cases} \text{for any } \varepsilon > 0, \exists c_0 \geq 0, 0 \leq \tau < 2, \eta_\varepsilon \in L^1_q[0, 1] \text{ with} \\ \eta_\varepsilon \geq 0 \text{ a.e. on } (0, 1) \text{ with } |f(t, u)| \leq c_0 u^\tau + \eta_\varepsilon(t) \\ \text{for } t \in (0, 1) \text{ and } u \geq \varepsilon; \end{cases} \quad (2.123)$$

here λ_1 is the first eigenvalue of (2.109). Then (2.62) has a solution $y \in C[0, 1] \cap C^2(0, 1)$ with $y(t) \geq \alpha(t)$ for $t \in [0, 1]$.

PROOF. Proceed as in Theorem 2.23 and obtain a solution y_{n_0} of (2.113) with

$$\alpha(t) \leq \alpha_{n_0}(t) \leq y_{n_0}(t) \quad \text{for } t \in [0, 1].$$

Next we show

$$y_{n_0}(t) \leq M \quad \text{for } t \in [0, 1], \quad (2.124)$$

where $M (\geq \sup_{[0,1]} \alpha_{n_0}(t))$ is a predetermined constant (see below). Notice (2.123) (with $\varepsilon = \sup_{[0,1]} \alpha_{n_0}(t)$) implies that there exists $\eta_\varepsilon \in L^1_q[0, 1]$ (with $\eta_\varepsilon \geq 0$ a.e. on $[0, 1]$) with

$$|g_{n_0}^*(t, y_{n_0}(t))| \leq c_0 [y_{n_0}(t)]^\tau + \eta(t) + 1 \quad \text{for } t \in (0, 1);$$

here $\eta(t) = \max\{\eta_\varepsilon(t), \eta_\varepsilon(\theta_{n_0}(t))\}$. Also notice (2.123) implies that there exists $h_\varepsilon \in L^1_q[0, 1]$ (with $h_\varepsilon \geq 0$ a.e. on $[0, 1]$) with

$$y_{n_0}(t) g_{n_0}^*(t, y_{n_0}(t)) \leq d_0(t) [y_{n_0}(t)]^2 + b_0 [y_{n_0}(t)]^\gamma + [h(t) + 1] y_{n_0}(t)$$

for $t \in (0, 1)$ where

$$d_0(t) = \max\{a_0(t), a_0(\theta_{n_0}(t))\} \text{ and } h(t) = \max\{h_\varepsilon(t), h_\varepsilon(\theta_{n_0}(t))\};$$

note for fixed $t \in (\frac{1}{2^{n_0+1}}, 1)$ with $y_{n_0}(t) \geq M$ that

$$\begin{aligned} y_{n_0}(t) g_{n_0}^*(t, y_{n_0}(t)) &= y_{n_0}(t) [f(t, M) + r(M - y_{n_0}(t))] \\ &= \frac{y_{n_0}(t)}{M} [Mf(t, M) + Mr(M - y_{n_0}(t))] \\ &\leq \frac{y_{n_0}(t)}{M} [a_0(t)M^2 + b_0M^\gamma + h_\varepsilon(t)M + M] \\ &= y_{n_0}(t) [a_0(t)M + b_0M^{\gamma-1} + h_\varepsilon(t) + 1] \\ &\leq a_0(t) [y_{n_0}(t)]^2 + b_0 [y_{n_0}(t)]^\gamma + [h_\varepsilon(t) + 1] y_{n_0}(t) \end{aligned}$$

(the other cases are treated similarly). Let $v = y_{n_0} - \rho_{n_0}$ so

$$-vv'' = q(v + \rho_{n_0})g_{n_0}^*(t, v + \rho_{n_0}) - \rho_{n_0}qg_{n_0}^*(t, v + \rho_{n_0}).$$

As a result we have

$$\begin{aligned} \int_0^1 [v'(t)]^2 dt &\leq \int_0^1 q(t)d_0(t)[v(t) + \rho_{n_0}]^2 dt + b_0 \int_0^1 q(t)[v(t) + \rho_{n_0}]^\gamma dt \\ &\quad + \int_0^1 q(t)[h(t) + 1][v(t) + \rho_{n_0}] dt \\ &\quad + c_0\rho_{n_0} \int_0^1 q(t)[v(t) + \rho_{n_0}]^\tau dt + \rho_{n_0} \int_0^1 q(t)[\eta(t) + 1] dt, \end{aligned}$$

so

$$\begin{aligned} &\int_0^1 [(v'(t))^2 - q(t)d_0(t)v^2(t)] dt \\ &\leq \int_0^1 q(t)d_0(t)[2v(t)\rho_{n_0} + \rho_{n_0}^2] dt + b_0 \int_0^1 q(t)[v(t) + \rho_{n_0}]^\gamma dt \\ &\quad + \int_0^1 q(t)[h(t) + 1][v(t) + \rho_{n_0}] dt + c_0\rho_{n_0} \int_0^1 q(t)[v(t) + \rho_{n_0}]^\tau dt \\ &\quad + \rho_{n_0} \int_0^1 q(t)[\eta(t) + 1] dt. \end{aligned}$$

Notice $d_0(t) < \lambda_1$ on a subset of $[0, 1]$ of positive measure. The argument in [19, Chapter 11] guarantees that there exists a $\delta > 0$ with

$$\int_0^1 [(v'(t))^2 - q(t)d_0(t)v^2(t)] dt \geq \delta \left(\int_0^1 q(t)v^2(t) dt + \int_0^1 [v'(t)]^2 dt \right).$$

Consequently

$$\begin{aligned} &\delta \left(\int_0^1 q(t)v^2(t) dt + \int_0^1 [v'(t)]^2 dt \right) \\ &\leq \int_0^1 q(t)d_0(t)[2v(t)\rho_{n_0} + \rho_{n_0}^2] dt + b_0 \int_0^1 q(t)[v(t) + \rho_{n_0}]^\gamma dt \\ &\quad + \int_0^1 q(t)[h(t) + 1][v(t) + \rho_{n_0}] dt + c_0\rho_{n_0} \int_0^1 q(t)[v(t) + \rho_{n_0}]^\tau dt \\ &\quad + \rho_{n_0} \int_0^1 q(t)[\eta(t) + 1] dt, \end{aligned}$$

and this together with Hölder’s inequality and Theorem 2.22 (note $1 \leq \gamma < 2$ and $0 \leq \tau < 2$) guarantees that there exists a constant $K_0 \geq \sqrt{2} \sup_{[0,1]} \alpha_{n_0}(t)$ with $\|v'\|_2 \leq K_0$. Now if $M = \frac{1}{\sqrt{2}}K_0 + \rho_{n_0}$ then (2.124) holds. Essentially the same reasoning as in Theorem 2.23 (from (2.118) onwards) completes the proof. \square

REMARK 2.11. We can replace (2.72) and (2.74) in Theorem 2.26 with (2.96).

3. Singular initial value problems

In this section we discuss the singular initial value problem

$$\begin{cases} y' = q(t)f(t, y), & 0 < t < T (< \infty), \\ y(0) = 0, \end{cases} \tag{3.1}$$

where our nonlinearity f may change sign. We first present a variation of the classical theory of upper and lower solutions. We will assume the following conditions hold:

$$\begin{cases} \text{there exists } \beta \in C[0, T] \cap C^1(0, T] \text{ with} \\ \beta \in AC[0, T], \beta(0) \geq 0, \text{ and} \\ q(t)f(t, \beta(t)) \leq \beta'(t) \text{ for } t \in (0, T), \end{cases} \tag{3.2}$$

$$\begin{cases} \text{there exists } \alpha \in C[0, T] \cap C^1(0, T] \text{ with} \\ \alpha \in AC[0, T], \alpha(t) \leq \beta(t) \text{ on } [0, T], \alpha(0) \leq 0 \\ \text{and } q(t)f(t, \alpha(t)) \geq \alpha'(t) \text{ for } t \in (0, T) \end{cases} \tag{3.3}$$

and

$$q \in C(0, T) \cap L^1[0, T] \quad \text{with } q > 0 \text{ on } (0, T]. \tag{3.4}$$

Let

$$f^*(t, y) = \begin{cases} f(t, \beta(t)) + r(\beta(t) - y), & y \geq \beta(t), \\ f(t, y), & \alpha(t) < y < \beta(t), \\ f(t, \alpha(t)) + r(\alpha(t) - y), & y \leq \alpha(t), \end{cases}$$

where $r : \mathbf{R} \rightarrow [-1, 1]$ is the radial retraction. Finally we assume

$$f^* : [0, T] \times \mathbf{R} \rightarrow \mathbf{R} \quad \text{is continuous.} \tag{3.5}$$

THEOREM 3.1. *Suppose (3.2)–(3.5) hold. Then (3.1) has a solution y (here $y \in C[0, T] \cap C^1(0, T]$ with $y \in AC[0, T]$) with $\alpha(t) \leq y(t) \leq \beta(t)$ for $t \in [0, T]$.*

PROOF. To show (3.1) has a solution we consider the problem

$$\begin{cases} y' = q(t)f^*(t, y), & 0 < t < T, \\ y(0) = 0. \end{cases} \tag{3.6}$$

Now Theorem 1.4 guarantees that (3.6) has a solution $y \in C[0, T] \cap C^1(0, T]$ with $y \in AC[0, T]$. The result of our theorem will follow once we show

$$\alpha(t) \leq y(t) \leq \beta(t) \quad \text{for } t \in [0, T]. \quad (3.7)$$

We now show

$$y(t) \leq \beta(t) \quad \text{for } t \in [0, T]. \quad (3.8)$$

Suppose (3.8) is not true. Then since $y(0) \leq \beta(0)$ there exists $t_1 < t_2 \in [0, T]$ with

$$y(t_1) = \beta(t_1), \quad y(t_2) > \beta(t_2) \quad \text{and} \quad y(t) > \beta(t) \quad \text{on } (t_1, t_2).$$

Thus

$$\begin{aligned} y(t_2) - y(t_1) &= \int_{t_1}^{t_2} q(s) [f(s, \beta(s)) + r(\beta(s) - y(s))] ds \\ &\leq \int_{t_1}^{t_2} \beta'(s) ds + \int_{t_1}^{t_2} q(s) r(\beta(s) - y(s)) ds \\ &< \beta(t_2) - \beta(t_1), \end{aligned}$$

i.e., $y(t_2) < \beta(t_2)$, a contradiction. Thus (3.8) is true. A similar argument shows

$$\alpha(t) \leq y(t) \quad \text{for } t \in [0, T]. \quad (3.9)$$

Our result follows. □

Again because of the difficulties encountered with checking (3.5) it is of interest to provide an alternative approach and to present conditions that are easy to verify in applications.

Our main result can be stated immediately.

THEOREM 3.2. *Let $n_0 \in \{1, 2, \dots\}$ be fixed and suppose the following conditions are satisfied:*

$$f : [0, T] \times (0, \infty) \rightarrow \mathbf{R} \quad \text{is continuous} \quad (3.10)$$

$$q \in C(0, T], \quad q > 0 \quad \text{on } (0, T] \quad \text{and} \quad \int_0^T q(x) dx < \infty \quad (3.11)$$

$$\left\{ \begin{array}{l} \text{let } n \in \{n_0, n_0 + 1, \dots\} \text{ and associated with each } n \text{ we} \\ \text{have a constant } \rho_n \text{ such that } \{\rho_n\} \text{ is a nonincreasing} \\ \text{sequence with } \lim_{n \rightarrow \infty} \rho_n = 0 \text{ and such that for} \\ \frac{T}{2^{n+1}} \leq t \leq T \text{ we have } q(t) f(t, \rho_n) \geq 0, \end{array} \right. \quad (3.12)$$

$$\left\{ \begin{array}{l} \text{there exists a function } \alpha \in C[0, T] \cap C^1(0, T] \\ \text{with } \alpha(0) = 0, \alpha > 0 \text{ on } (0, T] \text{ such} \\ \text{that } q(t)f(t, \alpha(t)) \geq \alpha'(t) \text{ for } t \in (0, T) \end{array} \right. \quad (3.13)$$

and

$$\left\{ \begin{array}{l} \text{there exists a function } \beta \in C[0, T] \cap C^1(0, T] \text{ with} \\ \beta(t) \geq \alpha(t) \text{ and } \beta(t) \geq \rho_{n_0} \text{ for } t \in [0, T] \text{ with} \\ q(t)f(t, \beta(t)) \leq \beta'(t) \text{ for } t \in (0, T) \text{ and} \\ q(t)f\left(\frac{T}{2^{n_0+1}}, \beta(t)\right) \leq \beta'(t) \text{ for } t \in \left(0, \frac{T}{2^{n_0+1}}\right). \end{array} \right. \quad (3.14)$$

Then (3.1) has a solution $y \in C[0, T] \cap C^1(0, T]$ with $y(t) \geq \alpha(t)$ for $t \in [0, T]$.

PROOF. For $n = n_0, n_0 + 1, \dots$ let

$$e_n = \left[\frac{T}{2^{n+1}}, T \right] \quad \text{and} \quad \theta_n(t) = \max \left\{ \frac{T}{2^{n+1}}, t \right\}, \quad 0 \leq t \leq T,$$

and

$$f_n(t, x) = \max \{ f(\theta_n(t), x), f(t, x) \}.$$

Next we define inductively

$$g_{n_0}(t, x) = f_{n_0}(t, x)$$

and

$$g_n(t, x) = \min \{ f_{n_0}(t, x), \dots, f_n(t, x) \}, \quad n = n_0 + 1, n_0 + 2, \dots$$

Notice

$$f(t, x) \leq \dots \leq g_{n+1}(t, x) \leq g_n(t, x) \leq \dots \leq g_{n_0}(t, x)$$

for $(t, x) \in (0, T) \times (0, \infty)$ and

$$g_n(t, x) = f(t, x) \quad \text{for } (t, x) \in e_n \times (0, \infty).$$

Without loss of generality assume $\rho_{n_0} \leq \min_{t \in [\frac{T}{2}, T]} \alpha(t)$. Fix $n \in \{n_0, n_0 + 1, \dots\}$. Let $t_n \in [0, \frac{T}{2}]$ be such that

$$\alpha(t_n) = \rho_n \quad \text{and} \quad \alpha(t) \leq \rho_n \quad \text{for } t \in [0, t_n].$$

Define

$$\alpha_n(t) = \begin{cases} \rho_n & \text{if } t \in [0, t_n], \\ \alpha(t) & \text{if } t \in (t_n, T]. \end{cases}$$

Notice $\alpha_{n+1}(t) \leq \alpha_n(t)$, $t \in [0, T]$, for each $n \in \{n_0, n_0 + 1, \dots\}$ since $\{\rho_n\}$ is a nonincreasing sequence. We begin with the initial value problem

$$\begin{cases} y' = q(t)g_{n_0}^*(t, y), & 0 < t < T, \\ y(0) = \rho_{n_0}; \end{cases} \quad (3.15)$$

here

$$g_{n_0}^*(t, y) = \begin{cases} g_{n_0}(t, \alpha_{n_0}(t)), & y \leq \alpha_{n_0}(t), \\ g_{n_0}(t, y), & \alpha_{n_0}(t) \leq y \leq \beta(t), \\ g_{n_0}(t, \beta(t)), & y \geq \beta(t). \end{cases}$$

From Schauder's fixed point theorem we know that (3.15) has a solution $y_{n_0} \in C[0, T] \cap C^1(0, T]$. We first show

$$y_{n_0}(t) \geq \alpha_{n_0}(t), \quad t \in [0, T]. \quad (3.16)$$

Suppose (3.16) is not true. Then there exists $\tau_1 < \tau_2 \in [0, T]$ with

$$y_{n_0}(\tau_1) = \alpha_{n_0}(\tau_1), \quad y_{n_0}(\tau_2) < \alpha_{n_0}(\tau_2)$$

and

$$y_{n_0}(t) < \alpha_{n_0}(t) \quad \text{for } t \in (\tau_1, \tau_2).$$

Of course

$$y_{n_0}(\tau_2) - \alpha_{n_0}(\tau_2) = \int_{\tau_1}^{\tau_2} (y_{n_0} - \alpha_{n_0})'(t) dt. \quad (3.17)$$

We now claim

$$(y_{n_0} - \alpha_{n_0})'(t) \geq 0 \quad \text{for a.e. } t \in (\tau_1, \tau_2). \quad (3.18)$$

If (3.18) is true then (3.17) implies

$$y_{n_0}(\tau_2) - \alpha_{n_0}(\tau_2) \geq 0,$$

a contradiction. As a result if we show (3.18) is true then (3.16) will follow. To see (3.18) we will show

$$(y_{n_0} - \alpha_{n_0})'(t) \geq 0 \quad \text{for } t \in (\tau_1, \tau_2) \text{ provided } t \neq t_{n_0}.$$

Fix $t \in (\tau_1, \tau_2)$ and assume $t \neq t_{n_0}$. Then

$$\begin{aligned} (y_{n_0} - \alpha_{n_0})'(t) &= [q(t)g_{n_0}(t, \alpha_{n_0}(t)) - \alpha'_{n_0}(t)] \\ &= \begin{cases} q(t)g_{n_0}(t, \alpha(t)) - \alpha'(t) & \text{if } t \in (t_{n_0}, T), \\ q(t)g_{n_0}(t, \rho_{n_0}) & \text{if } t \in (0, t_{n_0}). \end{cases} \end{aligned}$$

Case (i). $t \geq \frac{T}{2^{n_0+1}}$.

Then since $g_{n_0}(t, x) = f(t, x)$ for $x \in (0, \infty)$ we have

$$\begin{aligned} (y_{n_0} - \alpha_{n_0})'(t) &= \begin{cases} q(t)f(t, \alpha(t)) - \alpha'(t) & \text{if } t \in (t_{n_0}, T), \\ q(t)f(t, \rho_{n_0}) & \text{if } t \in (0, t_{n_0}) \end{cases} \\ &\geq 0, \end{aligned}$$

from (3.12) and (3.13).

Case (ii). $t \in (0, \frac{T}{2^{n_0+1}})$.

Then since

$$g_{n_0}(t, x) = \max \left\{ f\left(\frac{T}{2^{n_0+1}}, x\right), f(t, x) \right\}$$

we have $g_{n_0}(t, x) \geq f(t, x)$ and $g_{n_0}(t, x) \geq f(\frac{T}{2^{n_0+1}}, x)$ for $x \in (0, \infty)$. Thus we have

$$\begin{aligned} (y_{n_0} - \alpha_{n_0})'(t) &\geq \begin{cases} q(t)f(t, \alpha(t)) - \alpha'(t) & \text{if } t \in (t_{n_0}, T), \\ q(t)f(\frac{T}{2^{n_0+1}}, \rho_{n_0}) & \text{if } t \in (0, t_{n_0}) \end{cases} \\ &\geq 0, \end{aligned}$$

from (3.12) and (3.13).

Consequently (3.18) (and so (3.16)) holds and now since $\alpha(t) \leq \alpha_{n_0}(t)$ for $t \in [0, T]$ we have

$$\alpha(t) \leq \alpha_{n_0}(t) \leq y_{n_0}(t) \quad \text{for } t \in [0, T]. \tag{3.19}$$

Next we show

$$y_{n_0}(t) \leq \beta(t) \quad \text{for } t \in [0, T]. \tag{3.20}$$

If (3.20) is not true then there exists $\tau_1 < \tau_2 \in [0, T]$ with

$$y_{n_0}(\tau_1) = \beta(\tau_1), \quad y_{n_0}(\tau_2) > \beta(\tau_2) \quad \text{and} \quad y_{n_0}(t) > \beta(t) \quad \text{for } t \in (\tau_1, \tau_2).$$

Notice also that

$$y_{n_0}(\tau_2) - y_{n_0}(\tau_1) = \int_{\tau_1}^{\tau_2} q(s)g_{n_0}(s, \beta(s)) \, ds.$$

There are three cases to consider, namely (i) $\frac{T}{2^{n_0+1}} \leq \tau_1$; (ii) $\tau_1 < \tau_2 \leq \frac{T}{2^{n_0+1}}$; and (iii) $\tau_1 < \frac{T}{2^{n_0+1}} < \tau_2$.

Case (i). $\frac{T}{2^{n_0+1}} \leq \tau_1$.

Since $g_{n_0}(t, x) = f(t, x)$ for $(t, x) \in (\tau_1, \tau_2) \times (0, \infty)$ we have

$$y_{n_0}(\tau_2) - y_{n_0}(\tau_1) = \int_{\tau_1}^{\tau_2} q(s) f(s, \beta(s)) ds \leq \int_{\tau_1}^{\tau_2} \beta'(s) ds = \beta(\tau_2) - \beta(\tau_1),$$

a contradiction.

Case (ii). $\tau_1 < \tau_2 \leq \frac{T}{2^{n_0+1}}$.

Since

$$g_{n_0}(t, x) = \max \left\{ f \left(\frac{T}{2^{n_0+1}}, x \right), f(t, x) \right\}$$

for $(t, x) \in (\tau_1, \tau_2) \times (0, \infty)$ we have

$$\begin{aligned} y_{n_0}(\tau_2) - y_{n_0}(\tau_1) &= \int_{\tau_1}^{\tau_2} q(s) \max \left\{ f \left(\frac{T}{2^{n_0+1}}, \beta(s) \right), f(s, \beta(s)) \right\} \\ &\leq \int_{\tau_1}^{\tau_2} \beta'(s) ds = \beta(\tau_2) - \beta(\tau_1), \end{aligned}$$

a contradiction.

Case (iii). $\tau_1 < \frac{T}{2^{n_0+1}} < \tau_2$.

Now

$$\begin{aligned} y_{n_0} \left(\frac{T}{2^{n_0+1}} \right) - y_{n_0}(\tau_1) &= \int_{\tau_1}^{\frac{T}{2^{n_0+1}}} q(s) \max \left\{ f \left(\frac{T}{2^{n_0+1}}, \beta(s) \right), f(s, \beta(s)) \right\} \\ &\leq \int_{\tau_1}^{\frac{T}{2^{n_0+1}}} \beta'(s) ds = \beta \left(\frac{T}{2^{n_0+1}} \right) - \beta(\tau_1) \end{aligned}$$

and

$$y_{n_0}(\tau_2) - y_{n_0} \left(\frac{T}{2^{n_0+1}} \right) = \int_{\frac{T}{2^{n_0+1}}}^{\tau_2} q(s) f(s, \beta(s)) ds \leq \beta(\tau_2) - \beta \left(\frac{T}{2^{n_0+1}} \right).$$

Combine to obtain

$$y_{n_0}(\tau_2) - y_{n_0}(\tau_1) \leq \beta(\tau_2) - \beta(\tau_1),$$

a contradiction.

Thus (3.20) holds, so we have

$$\alpha(t) \leq \alpha_{n_0}(t) \leq y_{n_0}(t) \leq \beta(t) \quad \text{for } t \in [0, T].$$

Next we consider

$$\begin{cases} y' = q(t)g_{n_0+1}^*(t, y), & 0 < t < T, \\ y(0) = \rho_{n_0+1}; \end{cases} \quad (3.21)$$

here

$$g_{n_0+1}^*(t, y) = \begin{cases} g_{n_0+1}(t, \alpha_{n_0+1}(t)), & y \leq \alpha_{n_0+1}(t), \\ g_{n_0+1}(t, y), & \alpha_{n_0+1}(t) \leq y \leq y_{n_0}(t), \\ g_{n_0+1}(t, y_{n_0}(t)), & y \geq y_{n_0}(t). \end{cases}$$

Now Schauder's fixed point theorem guarantees that (3.21) has a solution $y_{n_0+1} \in C[0, T] \cap C^1(0, T]$. We first show

$$y_{n_0+1}(t) \geq \alpha_{n_0+1}(t), \quad t \in [0, T]. \quad (3.22)$$

Suppose (3.22) is not true. Then there exists $\tau_1 < \tau_2 \in [0, T]$ with

$$y_{n_0+1}(\tau_1) = \alpha_{n_0+1}(\tau_1), \quad y_{n_0+1}(\tau_2) < \alpha_{n_0+1}(\tau_2)$$

and

$$y_{n_0+1}(t) < \alpha_{n_0+1}(t) \quad \text{for } t \in (\tau_1, \tau_2).$$

If we show

$$(y_{n_0+1} - \alpha_{n_0+1})'(t) \geq 0 \quad \text{for a.e. } t \in (\tau_1, \tau_2), \quad (3.23)$$

then as before (3.22) is true. Fix $t \in (\tau_1, \tau_2)$ and assume $t \neq t_{n_0+1}$. Then

$$\begin{aligned} (y_{n_0+1} - \alpha_{n_0+1})'(t) &= [q(t)g_{n_0+1}(t, \alpha_{n_0+1}(t)) - \alpha'_{n_0+1}(t)] \\ &= \begin{cases} q(t)g_{n_0+1}(t, \alpha(t)) - \alpha'(t) & \text{if } t \in (t_{n_0+1}, T), \\ q(t)g_{n_0+1}(t, \rho_{n_0+1}) & \text{if } t \in (0, t_{n_0+1}). \end{cases} \end{aligned}$$

Case (i). $t \geq \frac{T}{2^{n_0+2}}$.

Then since $g_{n_0+1}(t, x) = f(t, x)$ for $x \in (0, \infty)$ we have

$$\begin{aligned} (y_{n_0+1} - \alpha_{n_0+1})'(t) &= \begin{cases} q(t)f(t, \alpha(t)) - \alpha'(t) & \text{if } t \in (t_{n_0+1}, T), \\ q(t)f(t, \rho_{n_0+1}) & \text{if } t \in (0, t_{n_0+1}) \end{cases} \\ &\geq 0, \end{aligned}$$

from (3.12) and (3.13).

Case (ii). $t \in (0, \frac{T}{2^{n_0+2}})$.

Then since $g_{n_0+1}(t, x)$ equals

$$\min \left\{ \max \left\{ f \left(\frac{T}{2^{n_0+1}}, x \right), f(t, x) \right\}, \max \left\{ f \left(\frac{T}{2^{n_0+2}}, x \right), f(t, x) \right\} \right\}$$

we have

$$g_{n_0+1}(t, x) \geq f(t, x)$$

and

$$g_{n_0+1}(t, x) \geq \min \left\{ f \left(\frac{T}{2^{n_0+1}}, x \right), f \left(\frac{T}{2^{n_0+2}}, x \right) \right\}$$

for $x \in (0, \infty)$. Thus we have

$$\begin{aligned} (y_{n_0+1} - \alpha_{n_0+1})'(t) &\leq \begin{cases} q(t)f(t, \alpha(t)) - \alpha'(t) & \text{if } t \in (t_{n_0+1}, T), \\ q(t) \min \left\{ f \left(\frac{T}{2^{n_0+1}}, \rho_{n_0+1} \right), f \left(\frac{T}{2^{n_0+2}}, \rho_{n_0+1} \right) \right\} & \text{if } t \in (0, t_{n_0+1}) \end{cases} \\ &\geq 0, \end{aligned}$$

from (3.12) and (3.13) (note $f(\frac{T}{2^{n_0+1}}, \rho_{n_0+1}) \geq 0$ since $f(t, \rho_{n_0+1}) \geq 0$ for $t \in [\frac{T}{2^{n_0+2}}, T]$ and $\frac{T}{2^{n_0+1}} \in (\frac{T}{2^{n_0+2}}, T)$).

Consequently (3.23) is true so

$$\alpha(t) \leq \alpha_{n_0+1}(t) \leq y_{n_0+1}(t) \quad \text{for } t \in [0, T]. \quad (3.24)$$

Next we show

$$y_{n_0+1}(t) \leq y_{n_0}(t) \quad \text{for } t \in [0, T]. \quad (3.25)$$

If (3.25) is not true then there exists $\tau_1 < \tau_2 \in [0, T]$ with

$$y_{n_0+1}(\tau_1) = y_{n_0}(\tau_1), \quad y_{n_0+1}(\tau_2) > y_{n_0}(\tau_2)$$

and

$$y_{n_0+1}(t) > y_{n_0}(t) \quad \text{for } t \in (\tau_1, \tau_2).$$

Notice also since $g_{n_0}(t, x) \geq g_{n_0+1}(t, x)$ for $(t, x) \in (0, T) \times (0, \infty)$ that

$$y_{n_0+1}(\tau_2) - y_{n_0+1}(\tau_1) = \int_{\tau_1}^{\tau_2} q(s)g_{n_0+1}(s, y_{n_0}(s)) ds$$

$$\begin{aligned} &\leq \int_{\tau_1}^{\tau_2} q(s)g_{n_0}(s, y_{n_0}(s)) \, ds \\ &= \int_{\tau_1}^{\tau_2} y'_{n_0}(s) \, ds = y_{n_0}(\tau_2) - y_{n_0}(\tau_1), \end{aligned}$$

a contradiction.

Now proceed inductively to construct $y_{n_0+2}, y_{n_0+3}, \dots$ as follows. Suppose we have y_k for some $k \in \{n_0 + 1, n_0 + 2, \dots\}$ with $\alpha_k(t) \leq y_k(t) \leq y_{k-1}(t)$ for $t \in [0, T]$. Then consider the boundary value problem

$$\begin{cases} y' = q(t)g_{k+1}^*(t, y), & 0 < t < T, \\ y(0) = \rho_{k+1}; \end{cases} \tag{3.26}$$

here

$$g_{k+1}^*(t, y) = \begin{cases} g_{k+1}(t, \alpha_{k+1}(t)), & y \leq \alpha_{k+1}(t), \\ g_{k+1}(t, y), & \alpha_{k+1}(t) \leq y \leq y_k(t), \\ g_{k+1}(t, y_k(t)), & y \geq y_k(t). \end{cases}$$

Now Schauder’s fixed point theorem guarantees that (3.26) has a solution $y_{k+1} \in C[0, T] \cap C^1(0, T]$, and essentially the same reasoning as above yields

$$\alpha(t) \leq \alpha_{k+1}(t) \leq y_{k+1}(t) \leq y_k(t) \quad \text{for } t \in [0, T]. \tag{3.27}$$

Thus for each $n \in \{n_0, n_0 + 1, \dots\}$ we have

$$\alpha(t) \leq y_n(t) \leq y_{n-1}(t) \leq \dots \leq y_{n_0}(t) \leq \beta(t) \quad \text{for } t \in [0, T]. \tag{3.28}$$

Lets look at the interval $[\frac{T}{2^{n_0+1}}, T]$. Let

$$R_{n_0} = \sup \left\{ |q(x)f(x, y)| : x \in \left[\frac{T}{2^{n_0+1}}, T \right] \text{ and } \alpha(x) \leq y \leq y_{n_0}(x) \right\}.$$

We have immediately that

$$\begin{cases} \{y_n\}_{n=n_0+1}^\infty \text{ is a bounded, equicontinuous} \\ \text{family on } \left[\frac{T}{2^{n_0+1}}, T \right]. \end{cases} \tag{3.29}$$

The Arzela–Ascoli theorem guarantees the existence of a subsequence N_{n_0} of integers and a function $z_{n_0} \in C[\frac{T}{2^{n_0+1}}, T]$ with y_n converging uniformly to z_{n_0} on $[\frac{T}{2^{n_0+1}}, T]$ as $n \rightarrow \infty$ through N_{n_0} . Proceed inductively to obtain subsequences of integers

$$N_{n_0} \supseteq N_{n_0+1} \supseteq \dots \supseteq N_k \supseteq \dots$$

and functions

$$z_k \in C \left[\frac{T}{2^{k+1}}, T \right]$$

with

$$y_n \text{ converging uniformly to } z_k \text{ on } \left[\frac{T}{2^{k+1}}, T \right]$$

as $n \rightarrow \infty$ through N_k , and

$$z_k = z_{k-1} \quad \text{on } \left[\frac{T}{2^k}, T \right].$$

Define a function $y : [0, T] \rightarrow [0, \infty)$ by $y(x) = z_k(x)$ on $[\frac{T}{2^{k+1}}, T]$ and $y(0) = 0$. Notice y is well defined and $\alpha(t) \leq y(t) \leq y_{n_0}(t) (\leq \beta(t))$ for $t \in (0, T)$. Fix $t \in (0, T)$ and let $m \in \{n_0, n_0 + 1, \dots\}$ be such that $\frac{T}{2^{m+1}} < t < T$. Let $N_m^* = \{n \in N_m : n \geq m\}$. Now y_n , $n \in N_m^*$, satisfies

$$\begin{aligned} y_n(t) &= y_n(T) - \int_t^T q(s) g_n^*(s, y_n(s)) \, ds \\ &= y_n(T) - \int_t^T q(s) f(s, y_n(s)) \, ds. \end{aligned}$$

Let $n \rightarrow \infty$ through N_m^* to obtain

$$y(t) = y(T) - \int_t^T q(s) f(s, y(s)) \, ds.$$

We can do this argument for each $t \in (0, T)$. It remains to show y is continuous at 0.

Let $\varepsilon > 0$ be given. Now since $\lim_{n \rightarrow \infty} y_n(0) = 0$ there exists $n_1 \in \{n_0, n_0 + 1, \dots\}$ with $y_{n_1}(0) < \frac{\varepsilon}{2}$. Since $y_{n_1} \in C[0, T]$ there exists $\delta_{n_1} > 0$ with

$$y_{n_1}(t) < \frac{\varepsilon}{2} \quad \text{for } t \in [0, \delta_{n_1}].$$

Now for $n \geq n_1$ we have, since $\{y_n(t)\}$ is nonincreasing for each $t \in [0, T]$,

$$\alpha(t) \leq y_n(t) \leq y_{n_1}(t) < \frac{\varepsilon}{2} \quad \text{for } t \in [0, \delta_{n_1}].$$

Consequently

$$\alpha(t) \leq y(t) \leq \frac{\varepsilon}{2} < \varepsilon \quad \text{for } t \in (0, \delta_{n_1}],$$

and so y is continuous at 0. Thus $y \in C[0, T]$. □

Suppose (3.10)–(3.13) hold, and in addition assume the following conditions are satisfied:

$$q(t)f(t, y) \geq \alpha'(t) \quad \text{for } (t, y) \in (0, T) \times \{y \in (0, \infty): y < \alpha(t)\} \quad (3.30)$$

and

$$\begin{cases} \text{there exists a function } \beta \in C[0, T] \cap C^1(0, T] \text{ with} \\ \beta(t) \geq \rho_{n_0} \text{ for } t \in [0, T] \text{ with } q(t)f(t, \beta(t)) \leq \beta'(t) \\ \text{for } t \in (0, T) \text{ and } q(t)f\left(\frac{T}{2^{n_0+1}}, \beta(t)\right) \leq \beta'(t) \\ \text{for } t \in \left(0, \frac{T}{2^{n_0+1}}\right). \end{cases} \quad (3.31)$$

Then the result in Theorem 3.2 is again true. This follows immediately from Theorem 3.2 once we show (3.14) holds, i.e., once we show $\beta(t) \geq \alpha(t)$ for $t \in [0, T]$. Suppose it is false. Then there exists $\tau_1 < \tau_2 \in [0, T]$ with

$$\beta(\tau_1) = \alpha(\tau_1), \quad \beta(\tau_2) < \alpha(\tau_2) \quad \text{and} \quad \beta(t) < \alpha(t) \quad \text{for } t \in (\tau_1, \tau_2).$$

Now for $t \in (\tau_1, \tau_2)$, we have from (3.30) that

$$q(t)f(t, \beta(t)) \geq \alpha'(t),$$

and as a result

$$\begin{aligned} \beta(\tau_2) - \beta(\tau_1) &= \int_{\tau_1}^{\tau_2} \beta'(s) \, ds \geq \int_{\tau_1}^{\tau_2} q(s)f(s, \beta(s)) \, ds \\ &\geq \int_{\tau_1}^{\tau_2} \alpha'(s) \, ds = \alpha(\tau_2) - \alpha(\tau_1), \end{aligned}$$

a contradiction. Thus we have

COROLLARY 3.3. *Let $n_0 \in \{1, 2, \dots\}$ be fixed and suppose (3.10)–(3.13), (3.30) and (3.31) hold. Then (3.1) has a solution $y \in C[0, T] \cap C^1(0, T]$ with $y(t) \geq \alpha(t)$ for $t \in [0, T]$.*

Next we discuss how to construct the lower solution α in (3.13) and in (3.30). Suppose the following condition is satisfied:

$$\begin{cases} \text{let } n \in \{n_0, n_0 + 1, \dots\} \text{ and associated with each } n \text{ we} \\ \text{have a constant } \rho_n \text{ such that } \{\rho_n\} \text{ is a decreasing} \\ \text{sequence with } \lim_{n \rightarrow \infty} \rho_n = 0 \text{ and there exists a} \\ \text{constant } k_0 > 0 \text{ such that for } \frac{T}{2^{n+1}} \leq t \leq T \\ \text{and } 0 < y \leq \rho_n \text{ we have } q(t)f(t, y) \geq k_0. \end{cases} \quad (3.32)$$

Then an argument similar to the one before Theorem 2.14 guarantees that there exists a $\alpha \in C[0, T] \cap C^1(0, T]$, $\alpha(0) = 0$, $\alpha > 0$ for $t \in (0, T]$, $\alpha(t) \leq \rho_{n_0}$ for $t \in [0, T]$ with (3.13) and (3.30) holding. We combine this with Corollary 3.3 to obtain our next result.

THEOREM 3.4. *Let $n_0 \in \{1, 2, \dots\}$ be fixed and suppose (3.10), (3.11), (3.31), and (3.32) hold. Then (3.1) has a solution $y \in C[0, T] \cap C^1(0, T]$ with $y(t) > 0$ for $t \in (0, T]$.*

Looking at Theorem 3.4 we see that the main difficulty when discussing examples is the construction of the β in (3.31). Our next result replaces (3.31) with a growth condition. We first present the result in its full generality.

THEOREM 3.5. *Let $n_0 \in \{1, 2, \dots\}$ be fixed and suppose (3.10)–(3.13) hold. Also assume the following condition is satisfied:*

$$\begin{cases} |f(t, y)| \leq g(y) + h(y) \text{ on } [0, T] \times (0, \infty) \text{ with} \\ g > 0 \text{ continuous and nonincreasing on } (0, \infty) \\ \text{and } h \geq 0 \text{ continuous on } [0, \infty). \end{cases} \tag{3.33}$$

Also suppose there exists a constant $M > 0$ with $G^{-1}(M) > \sup_{t \in [0, T]} \alpha(t)$ and with

$$\int_0^T q(x) \, dx < \int_0^M \frac{ds}{\left[1 + \frac{h(G^{-1}(s))}{g(G^{-1}(s))}\right]} \tag{3.34}$$

holding; here $G(z) = \int_0^z \frac{du}{g(u)}$ (note G is an increasing map from $[0, \infty)$ onto $[0, \infty)$ with $G(0) = 0$). Then (3.1) has a solution $y \in C[0, T] \cap C^1(0, T]$ with $y(t) \geq \alpha(t)$ for $t \in [0, T]$.

PROOF. Choose $\varepsilon > 0$, $\varepsilon < M$ with

$$\int_0^T q(x) \, dx < \int_\varepsilon^M \frac{ds}{\left[1 + \frac{h(G^{-1}(s))}{g(G^{-1}(s))}\right]}. \tag{3.35}$$

Without loss of generality assume $G(\rho_{n_0}) < \varepsilon$. Let e_n, θ_n, f_n, g_n and α_n be as in Theorem 3.2. We consider the boundary value problem (3.15) with in this case $g_{n_0}^*$ given by

$$g_{n_0}^*(t, y) = \begin{cases} g_{n_0}(t, \alpha_{n_0}(t)), & y \leq \alpha_{n_0}(t), \\ g_{n_0}(t, y), & \alpha_{n_0}(t) \leq y \leq G^{-1}(M), \\ g_{n_0}(t, G^{-1}(M)), & y \geq G^{-1}(M). \end{cases}$$

Essentially the same reasoning as in Theorem 3.2 implies that (3.15) has a solution y_{n_0} with $y_{n_0}(t) \geq \alpha_{n_0}(t) \geq \alpha(t)$ for $t \in [0, T]$. Next we show

$$y_{n_0}(t) < G^{-1}(M) \quad \text{for } t \in [0, T]. \tag{3.36}$$

Suppose (3.36) is false. Then since $y_{n_0}(0) = \rho_{n_0}$ there exists $\tau_1 < \tau_2 \in [0, T]$ with

$$\rho_{n_0} \leq y_{n_0}(t) \leq G^{-1}(M) \quad \text{for } t \in (\tau_1, \tau_2),$$

with

$$y_{n_0}(\tau_1) = \rho_{n_0} \quad \text{and} \quad y_{n_0}(\tau_2) = G^{-1}(M).$$

Now for $t \in (\tau_1, \tau_2)$ we have from (3.33) that

$$g^*(t, y_{n_0}(t)) \leq g(y_{n_0}(t)) + h(y_{n_0}(t)) = g(y_{n_0}(t)) \left\{ 1 + \frac{h(y_{n_0}(t))}{g(y_{n_0}(t))} \right\}.$$

Thus

$$\frac{y'_{n_0}(t)}{g(y_{n_0}(t))} \leq q(t) \left\{ 1 + \frac{h(y_{n_0}(t))}{g(y_{n_0}(t))} \right\} \quad \text{for } t \in (\tau_1, \tau_2).$$

Let

$$v_{n_0}(t) = \int_0^{y_{n_0}(t)} \frac{du}{g(u)} = G(y_{n_0}(t))$$

and so

$$v'_{n_0}(t) \leq q(t) \left\{ 1 + \frac{h(G^{-1}(v_{n_0}(t)))}{g(G^{-1}(v_{n_0}(t)))} \right\} \quad \text{for } t \in (\tau_1, \tau_2).$$

Integrate from τ_1 to τ_2 to obtain

$$\begin{aligned} \int_{\varepsilon}^{v_{n_0}(\tau_2)} \frac{ds}{\left[1 + \frac{h(G^{-1}(s))}{g(G^{-1}(s))}\right]} &\leq \int_{G(\rho_{n_0})}^{v_{n_0}(\tau_2)} \frac{ds}{\left[1 + \frac{h(G^{-1}(s))}{g(G^{-1}(s))}\right]} \leq \int_0^T q(s) ds \\ &< \int_{\varepsilon}^M \frac{ds}{\left[1 + \frac{h(G^{-1}(s))}{g(G^{-1}(s))}\right]}. \end{aligned}$$

Consequently $v_{n_0}(\tau_2) < M$ so $y_{n_0}(\tau_2) < G^{-1}(M)$. This is a contradiction. Thus (3.36) holds and so

$$\alpha(t) \leq \alpha_{n_0}(t) \leq y_{n_0}(t) < G^{-1}(M) \quad \text{for } t \in [0, T]. \tag{3.37}$$

Essentially the same reasoning as in Theorem 3.2 (from (3.21) onwards) completes the proof. \square

COROLLARY 3.6. Let $n_0 \in \{1, 2, \dots\}$ be fixed and suppose (3.10)–(3.13), (3.30) and (3.33) hold. In addition assume there is a constant $M > 0$ with

$$\int_0^T q(x) \, dx < \int_0^M \frac{ds}{\left[1 + \frac{h(G^{-1}(s))}{g(G^{-1}(s))}\right]} \quad (3.38)$$

holding; here $G(z) = \int_0^z \frac{du}{g(u)}$. Then (3.1) has a solution $y \in C[0, T] \cap C^1(0, T]$ with $y(t) \geq \alpha(t)$ for $t \in [0, T]$.

PROOF. This follows immediately from Theorem 3.5 once we show

$$G^{-1}(M) > \alpha(t) \quad \text{for each } t \in [0, T].$$

Suppose this is false. Then since $\alpha(0) = 0$ there exists $\tau_1 < \tau_2 \in [0, T]$ with

$$0 \leq \alpha(t) \leq G^{-1}(M) \quad \text{for } t \in (\tau_1, \tau_2), \alpha(\tau_1) = 0 \text{ and } \alpha(\tau_2) = G^{-1}(M).$$

Notice (3.30) implies

$$\alpha'(t) \leq q(t) f(t, \alpha(t)) \quad \text{for } t \in (\tau_1, \tau_2),$$

so we have

$$\frac{\alpha'(t)}{g(\alpha(t))} \leq q(t) \left\{ 1 + \frac{h(\alpha(t))}{g(\alpha(t))} \right\} \quad \text{for } t \in (\tau_1, \tau_2).$$

Let

$$v(t) = \int_0^{\alpha(t)} \frac{du}{g(u)} = G(\alpha(t)),$$

so

$$v'(t) \leq q(t) \left\{ 1 + \frac{h(G^{-1}(v(t)))}{g(G^{-1}(v(t)))} \right\} \quad \text{for } t \in (\tau_1, \tau_2).$$

Integrate from τ_1 to τ_2 to obtain

$$\int_0^{v(\tau_2)} \frac{ds}{\left[1 + \frac{h(G^{-1}(s))}{g(G^{-1}(s))}\right]} \leq \int_0^T q(s) \, ds < \int_0^M \frac{ds}{\left[1 + \frac{h(G^{-1}(s))}{g(G^{-1}(s))}\right]}.$$

Thus $v(\tau_2) < M$, so $\alpha(\tau_2) < G^{-1}(M)$, a contradiction. \square

Combining Corollary 3.6 with the comments before Theorem 3.4 yields the following theorem.

THEOREM 3.7. *Let $n_0 \in \{1, 2, \dots\}$ be fixed and suppose (3.10), (3.11), (3.32) and (3.33) hold. In addition assume there is a constant $M > 0$ with (3.38) holding. Then (3.1) has a solution $y \in C[0, T] \cap C^1(0, T]$ with $y(t) > 0$ for $t \in (0, T]$.*

Next we present some examples which illustrate how easily the theory is applied in practice.

EXAMPLE 3.1. The initial value problem

$$\begin{cases} y' = t^\theta y^{-\alpha} + y^\beta + A, & 0 < t < T (< \infty), \\ y(0) = 0 \end{cases} \tag{3.39}$$

with $\theta > -1, \alpha > 0, \beta > 0$ and $A > 0$ has a solution $y \in C[0, T] \cap C^1(0, T]$ with $y(t) > 0$ for $t \in (0, T]$ if

$$\int_0^T q(s) ds < \int_0^\infty \frac{ds}{1 + B[(\alpha + 1)s]^{\frac{\beta + \alpha}{\alpha + 1}} + AC[(\alpha + 1)s]^{\frac{\alpha}{\alpha + 1}}}; \tag{3.40}$$

here

$$q(t) = \begin{cases} 1 & \text{if } \theta \geq 0, \\ t^\theta & \text{if } -1 < \theta < 0, \end{cases}$$

with

$$B = \begin{cases} T^{\frac{\theta(\beta - 1)}{\alpha + 1}} & \text{if } \theta \geq 0, \\ T^{-\theta} & \text{if } -1 < \theta < 0, \end{cases}$$

and

$$C = \begin{cases} T^{-\frac{\theta}{\alpha + 1}} & \text{if } \theta \geq 0, \\ T^{-\theta} & \text{if } -1 < \theta < 0. \end{cases}$$

To see this we will apply Theorem 3.7. We will consider two cases, namely $\theta \geq 0$ and $-1 < \theta < 0$.

Case (i). $\theta \geq 0$.

We will apply Theorem 3.7 with

$$n_0 = 1, \quad q = 1, \quad g(y) = T^\theta y^{-\alpha}, \quad h(y) = y^\beta + A,$$

together with

$$\rho_n = \left(\frac{T^\theta}{2^{(n+1)\theta}} \right)^{1/\alpha} \quad \text{and} \quad k_0 = 1.$$

Clearly (3.10) and (3.11) hold. Also for $n \in \{1, 2, \dots\}$, $\frac{T}{2^{n+1}} \leq t \leq T$ and $0 < y \leq \rho_n$ we have

$$q(t)f(t, y) \geq t^\theta y^{-\alpha} \geq \left(\frac{T}{2^{n+1}}\right)^\theta \frac{1}{\rho_n^\alpha} = 1,$$

so (3.32) is satisfied. From (3.40) there exists $M > 0$ with

$$T < \int_0^M \frac{ds}{1 + B[(\alpha + 1)s]^{\frac{\beta + \alpha}{\alpha + 1}} + AC[(\alpha + 1)s]^{\frac{\alpha}{\alpha + 1}}},$$

so now (3.38) holds with this M since

$$G(z) = \frac{1}{T^\theta} \frac{z^{\alpha+1}}{\alpha + 1}, \quad \text{so} \quad G^{-1}(z) = [(\alpha + 1)z]^{\frac{1}{\alpha+1}} T^{\frac{\theta}{\alpha+1}}.$$

Existence of a solution to (3.39) is now guaranteed from Theorem 3.7.

Case (ii). $-1 < \theta < 0$.

We will apply Theorem 3.7 with

$$n_0 = 1, \quad q = t^\theta, \quad g(y) = y^{-\alpha}, \quad h(y) = T^{-\theta}[y^\beta + A],$$

together with

$$\rho_n = \left(\frac{T^\theta}{n}\right)^{1/\alpha} \quad \text{and} \quad k_0 = 1.$$

Clearly (3.10), (3.11) and (3.38) (as in Case (i)) hold. Also for $n \in \{1, 2, \dots\}$, $\frac{T}{2^{n+1}} \leq t \leq T$ and $0 < y \leq \rho_n$ we have

$$q(t)f(t, y) \geq t^\theta y^{-\alpha} \geq \frac{T^\theta}{\rho_n^\alpha} = n \geq 1,$$

so (3.32) is satisfied. Existence of a solution to (3.39) is now guaranteed from Theorem 3.7.

EXAMPLE 3.2. The initial value problem

$$\begin{cases} y' = t^\theta y^{-\alpha} + y^\beta - A, & 0 < t < T (< \infty), \\ y(0) = 0 \end{cases}$$

with $\theta > -1$, $\alpha > 0$, $\beta > 0$ and $A > 0$ has a solution $y \in C[0, T] \cap C^1(0, T]$ with $y(t) > 0$ for $t \in (0, T]$ if (3.40) holds.

The proof is essentially the same as in Example 3.1 with

$$\rho_n = \left(\frac{T^\theta}{2^{(n+1)\theta}(A+1)}\right)^{1/\alpha} \quad \text{if } \theta \geq 0$$

and

$$\rho_n = \left(\frac{T^\theta}{n(A+1)} \right)^{1/\alpha} \quad \text{if } -1 < \theta < 0.$$

EXAMPLE 3.3. The initial value problem

$$\begin{cases} y' = t^\theta (y^{-\alpha} + y^\beta + A), & 0 < t < T (< \infty), \\ y(0) = 0 \end{cases}$$

with $\theta > -1$, $\alpha > 0$, $\beta > 0$ and $A > 0$ has a solution $y \in C[0, T] \cap C^1(0, T]$ with $y(t) > 0$ for $t \in (0, T]$ if

$$\frac{T^{\theta+1}}{\theta+1} < \int_0^\infty \frac{ds}{1 + [(\alpha+1)s]^{\frac{\beta+\alpha}{\alpha+1}} + A[(\alpha+1)s]^{\frac{\alpha}{\alpha+1}}}.$$

Apply Theorem 3.7 with

$$q = t^\theta, \quad g(y) = y^{-\alpha} \quad \text{and} \quad h(y) = y^\beta + A.$$

References

- [1] R.P. Agarwal and D. O'Regan, *Positive solutions to superlinear singular boundary value problems*, J. Comput. Appl. Math. **88** (1998), 129–147.
- [2] R.P. Agarwal and D. O'Regan, *Twin solutions to singular Dirichlet problems*, J. Math. Anal. Appl. **240** (1999), 433–445.
- [3] R.P. Agarwal and D. O'Regan, *Existence theory for single and multiple solutions to singular positive boundary value problems*, J. Differential Equations **175** (2001), 393–414.
- [4] R.P. Agarwal, D. O'Regan, V. Lakshmikantham and S. Leela, *An upper and lower solution theory for singular Emden–Fowler equations*, Nonlinear Anal. (Real World Applications) **3** (2002), 275–291.
- [5] R.P. Agarwal, D. O'Regan and V. Lakshmikantham, *Existence criteria for singular initial value problems with sign changing nonlinearities*, Math. Problems Engrg. **7** (2001), 503–524.
- [6] R.P. Agarwal, D. O'Regan and P.J.Y. Wong, *Positive Solutions of Differential, Difference and Integral Equations*, Kluwer Academic, Dordrecht (1999).
- [7] R. Aris, *The Mathematical Theory of Diffusion and Reaction of Permeable Catalysts*, Clarendon, Oxford (1975).
- [8] J.V. Baxley, *A singular nonlinear boundary value problem: membrane response of a spherical cap*, SIAM J. Appl. Math. **48** (1988), 497–505.
- [9] L.E. Bobisud, *Behaviour of solutions for a Robin problem*, J. Differential Equations **85** (1990), 91–104.
- [10] L.E. Bobisud, J.E. Calvert and W.D. Royalty, *Some existence results for singular boundary value problems*, Differential Integral Equations **6** (1993), 553–571.
- [11] A. Callegari and A. Nachman, *Some singular nonlinear differential equations arising in boundary layer theory*, J. Math. Anal. Appl. **64** (1978), 96–105.
- [12] A. Callegari and A. Nachman, *A nonlinear singular boundary value problem in the theory of pseudoplastic fluids*, SIAM J. Appl. Math. **38** (1980), 275–282.
- [13] K. Deimling, *Nonlinear Functional Analysis*, Springer-Verlag, New York (1985).
- [14] P.W. Eloe and J. Henderson, *Singular nonlinear boundary value problems for higher order ordinary differential equations*, Nonlinear Anal. **17** (1991), 1–10.

- [15] J.A. Gatica, V. Olikar and P. Waltman, *Singular nonlinear boundary value problems for second order differential equations*, J. Differential Equations **79** (1989), 62–78.
- [16] P. Habets and F. Zanolin, *Upper and lower solutions for a generalized Emden–Fowler equation*, J. Math. Anal. Appl. **181** (1994), 684–700.
- [17] C.D. Luning and W.L. Perry, *Positive solutions of negative exponent generalized Emden–Fowler boundary value problems*, SIAM J. Math. Anal. **12** (1981), 874–879.
- [18] M.N. Nhashama, *A generalized upper and lower solution method and multiplicity results for nonlinear first order ordinary differential equations*, J. Math. Anal. Appl. **140** (1989), 381–395.
- [19] D. O'Regan, *Existence Theory for Nonlinear Ordinary Differential Equations*, Kluwer Academic, Dordrecht (1997).
- [20] S. Taliaferro, *A nonlinear singular boundary value problem*, Nonlinear Anal. **3** (1979), 897–904.
- [21] A. Tineo, *Existence theorems for a singular two point Dirichlet problem*, Nonlinear Anal. **19** (1992), 323–333.

CHAPTER 2

The Lower and Upper Solutions Method for Boundary Value Problems

C. De Coster

*Université du Littoral, 50 rue F. Buisson, BP 699, 62228 Calais Cédex, France
E-mail: colette.de.coster@lmpa.univ.littoral.fr*

P. Habets

*Université Catholique de Louvain, Institut de Mathématique Pure et Appliquée, Chemin du cyclotron 2,
1348 Louvain-la-Neuve, Belgium*

Contents

Introduction	71
1. Well ordered lower and upper solutions	73
1.1. A derivative independent periodic problem	73
1.2. A priori bounds on the derivatives	79
1.3. Derivative dependent periodic problems	83
1.4. Derivative dependent Dirichlet problem	89
1.5. A derivative independent Dirichlet problem	90
1.6. Historical and bibliographical notes	92
2. Relation with degree theory	94
2.1. The periodic problem	94
2.2. The Dirichlet problem	101
2.3. Non well-ordered lower and upper solutions	108
2.4. Historical and bibliographical notes	114
3. Variational methods	115
3.1. The minimization method	115
3.2. The minimax method	121
3.3. Historical and bibliographical notes	134
4. Monotone methods	135
4.1. Abstract results	135
4.2. Well-ordered lower and upper solutions	137
4.3. Lower and upper solutions in reversed order	145
4.4. A mixed approximation scheme	152

HANDBOOK OF DIFFERENTIAL EQUATIONS
Ordinary Differential Equations, volume 1
Edited by A. Cañada, P. Drábek and A. Fonda
© 2004 Elsevier B.V. All rights reserved

4.5. Historical and bibliographical notes	154
References	157

Introduction

The premises of the lower and upper solutions method can be traced back to Picard. In 1890 for partial differential equations [79] and in 1893 for ordinary differential equations [80], he introduced monotone iterations from a lower solution. This is the starting point of the use of lower and upper solutions in connection with monotone methods.

Independently, some of the basic ideas of the method appeared in the study of first order Cauchy problems made in 1915 by Perron [78] and in its extension to systems worked by Müller [72] in 1926. These authors deduced existence of solutions together with their localization between lower and upper solutions, i.e., ordered functions that satisfy differential inequalities. A good account of this theory can be found in Szarski [100] or Walter [101]. This approach is however limited to the Cauchy problem.

The major breakthrough was due to Scorza Dragoni in 1931. In two successive papers [94] and [95], this author introduced lower and upper solutions for the boundary value problem

$$u'' = f(t, u, u'), \quad u(a) = A, \quad u(b) = B,$$

i.e., he considered functions $\alpha, \beta \in C^2([a, b])$ such that $\alpha \leq \beta$ and

$$\alpha'' \geq f(t, \alpha, \alpha'), \quad \alpha(a) \leq A, \quad \alpha(b) \leq B,$$

$$\beta'' \leq f(t, \beta, \beta'), \quad \beta(a) \geq A, \quad \beta(b) \geq B.$$

As for the Cauchy problem, he proved existence of a solution u and its localization between the lower and the upper solutions

$$\alpha \leq u \leq \beta.$$

Section 1 describes the present evolution of these basic ideas.

In 1972, Amann [5] associated a degree to a pair of strict lower and upper solutions. The introduction of degree theory was essential to deal with a larger class of problems such as multiplicity results. An outline of this approach is given in Section 2.

Another important step was due independently to Chang [17,18] and de Figueiredo and Solimini [38]. In 1983 and 1984 respectively, they pointed out that between lower and upper solutions the related functional has a critical point which is a minimum. This was the starting point of results relating lower and upper solutions with the variational method. Section 3 presents basic results in this direction.

Recent results that extend the old idea of Picard to use lower and upper solutions with monotone methods are discussed in Section 4.

Throughout the paper we consider two basic problems, the periodic problem

$$u'' = f(t, u, u'), \quad u(a) = u(b), \quad u'(a) = u'(b), \quad (0.1)$$

and the Dirichlet problem

$$u'' = f(t, u, u'), \quad u(a) = 0, \quad u(b) = 0. \quad (0.2)$$

Although the method applies to a larger class of boundary value problems, we restrict attention to these two, in order to keep our work within a reasonable length. We also choose to describe only basic results and to select a small number of applications. A more thorough description of the method will appear in [33].

The type of nonlinearities $f : D \subset [a, b] \times \mathbb{R}^n \rightarrow \mathbb{R}$ ($n = 1$ or 2) we consider are *Carathéodory functions*, which means they satisfy the *Carathéodory conditions*:

- (a) for a.e. $t \in [a, b]$, the function $f(t, \cdot)$ with domain $\{z \in \mathbb{R}^n \mid (t, z) \in D\}$ is continuous;
- (b) for all $z \in \mathbb{R}^n$, the function $f(\cdot, z)$ with domain $\{t \in [a, b] \mid (t, z) \in D\}$ is measurable.

If further, for some $p \in [1, \infty]$, the Carathéodory function f satisfies

- (c) for all $r > 0$, there exists $h \in L^p(a, b)$ such that for all $(t, z) \in D$ with $|z| \leq r$, $|f(t, z)| \leq h(t)$,

we say that f is an *L^p -Carathéodory function* or that it satisfies an *L^p -Carathéodory condition*. The lower and upper solution method was first developed for continuous nonlinearities. The generalization to L^p -Carathéodory function is by no means trivial and brings a better understanding of the fundamentals of the method. This is why we adopted this framework as long as it does not imply an overwhelming technicality.

In this paper, we use the following notations:

$\mathcal{C}([a, b])$ is the set of continuous functions $u : [a, b] \rightarrow \mathbb{R}$;

$\mathcal{C}_0([a, b])$ is the set of functions $u \in \mathcal{C}([a, b])$, so that $u(a) = 0, u(b) = 0$;

$\mathcal{C}^1([a, b])$ is the set of differentiable functions $u : [a, b] \rightarrow \mathbb{R}$ so that $u' \in \mathcal{C}([a, b])$;

$\mathcal{C}_0^1([a, b])$ is the set of functions $u \in \mathcal{C}^1([a, b])$, so that $u(a) = 0, u(b) = 0$;

$L^2(a, b)$ is the set of measurable functions $u : [a, b] \rightarrow \mathbb{R}$ such that

$$\|u\|_{L^2} = \left[\int_a^b |u(t)|^2 dt \right]^{1/2} \in \mathbb{R};$$

$H_0^1(a, b)$ is the set of functions $u \in \mathcal{C}_0([a, b])$, with a weak derivative $u' \in L^2(a, b)$;

$W^{2,1}(a, b)$ is the set of functions $u \in \mathcal{C}^1([a, b])$, with a weak second derivative $u'' \in L^1(a, b)$;

given α and $\beta \in \mathcal{C}([a, b])$, we write $\alpha \leq \beta$ if $\alpha(t) \leq \beta(t)$ for all $t \in [a, b]$;

given α and $\beta \in \mathcal{C}([a, b])$, we define $[\alpha, \beta] = \{u \in \mathcal{C}([a, b]) \mid \alpha \leq u \leq \beta\}$;

$\mathbb{N}_0 = \mathbb{N} \setminus \{0\}$, $\mathbb{R}_0 = \mathbb{R} \setminus \{0\}$.

Given $u \in \mathcal{C}([a, b])$, we define the Dini derivatives

$$\begin{aligned} D_+ u(t) &= \liminf_{h \rightarrow 0^+} \frac{u(t+h) - u(t)}{h}, & D^+ u(t) &= \limsup_{h \rightarrow 0^+} \frac{u(t+h) - u(t)}{h}, \\ D_- u(t) &= \liminf_{h \rightarrow 0^-} \frac{u(t+h) - u(t)}{h}, & D^- u(t) &= \limsup_{h \rightarrow 0^-} \frac{u(t+h) - u(t)}{h}. \end{aligned}$$

Considering a function $u : [a, b] \rightarrow \mathbb{R}$, its *periodic extension on \mathbb{R}* is the function $u : \mathbb{R} \rightarrow \mathbb{R}$ defined from $u(t) \equiv u(t + b - a)$.

1. Well ordered lower and upper solutions

1.1. A derivative independent periodic problem

Consider the derivative independent periodic problem

$$u'' = f(t, u), \quad u(a) = u(b), \quad u'(a) = u'(b), \tag{1.1}$$

where f is an L^1 -Carathéodory function. Solutions of (1.1) are in $W^{2,1}(a, b)$ so that it is natural to look for lower and upper solutions which are in this space or at least which are piecewise $W^{2,1}$. This motivates the definitions we present here. To simplify the notations, we extend $f(t, u)$ by periodicity, i.e., $f(t, u) = f(t + b - a, u)$ for all $(t, u) \in \mathbb{R}^2$.

DEFINITIONS 1.1. A function $\alpha \in C([a, b])$ such that $\alpha(a) = \alpha(b)$ is a *lower solution* of (1.1) if its periodic extension on \mathbb{R} is such that for any $t_0 \in \mathbb{R}$ either $D_- \alpha(t_0) < D^+ \alpha(t_0)$, or there exists an open interval I_0 such that $t_0 \in I_0$, $\alpha \in W^{2,1}(I_0)$ and, for a.e. $t \in I_0$,

$$\alpha''(t) \geq f(t, \alpha(t)).$$

A function $\beta \in C([a, b])$ such that $\beta(a) = \beta(b)$ is an *upper solution* of (1.1) if its periodic extension on \mathbb{R} is such that for any $t_0 \in \mathbb{R}$ either $D^- \beta(t_0) > D_+ \beta(t_0)$, or there exists an open interval I_0 such that $t_0 \in I_0$, $\beta \in W^{2,1}(I_0)$ and, for a.e. $t \in I_0$,

$$\beta''(t) \leq f(t, \beta(t)).$$

Notice that the condition $D_- \alpha(t_0) < D^+ \alpha(t_0)$ cannot hold for all $t_0 \in [a, b]$. In practical problems it only holds at a finite number of points. Further the “natural” lower and upper solutions are often more regular than needed in Definitions 1.1. For example, a lower solution α will often be produced as the solution of some auxiliary problem so that it will be in $W^{2,1}(a, b)$ and satisfy for a.e. $t \in [a, b]$

$$\alpha''(t) \geq f(t, \alpha(t)), \quad \alpha(a) = \alpha(b), \quad \alpha'(a) \geq \alpha'(b).$$

The following theorem is the basic existence result of the lower and upper solutions method for solutions of the periodic problem (1.1).

THEOREM 1.1. *Let α and β be lower and upper solutions of (1.1) such that $\alpha \leq \beta$,*

$$E = \{(t, u) \in [a, b] \times \mathbb{R} \mid \alpha(t) \leq u \leq \beta(t)\} \tag{1.2}$$

and $f : E \rightarrow \mathbb{R}$ be an L^1 -Carathéodory function. Then the problem (1.1) has at least one solution $u \in W^{2,1}(a, b)$ such that for all $t \in [a, b]$

$$\alpha(t) \leq u(t) \leq \beta(t).$$

PROOF. We consider the modified problem

$$u'' - u = f(t, \gamma(t, u)) - \gamma(t, u), \quad u(a) = u(b), \quad u'(a) = u'(b), \quad (1.3)$$

where

$$\gamma(t, u) = \max\{\alpha(t), \min\{u, \beta(t)\}\}. \quad (1.4)$$

Claim 1. The problem (1.3) has at least one solution. Let us write (1.3) as an integral equation

$$u(t) = \int_a^b G(t, s)[f(s, \gamma(s, u(s))) - \gamma(s, u(s))] ds,$$

where $G(t, s)$ is the Green's function corresponding to the problem

$$u'' - u = f(t), \quad u(a) = u(b), \quad u'(a) = u'(b). \quad (1.5)$$

The operator

$$T : \mathcal{C}([a, b]) \rightarrow \mathcal{C}([a, b]),$$

defined by

$$(Tu)(t) = \int_a^b G(t, s)[f(s, \gamma(s, u(s))) - \gamma(s, u(s))] ds,$$

is completely continuous and bounded. By Schauder's theorem, T has a fixed point which is a solution of (1.3).

Claim 2. All solutions u of (1.3) satisfy on $[a, b]$

$$\alpha(t) \leq u(t) \leq \beta(t).$$

Let us assume on the contrary that, for some $t_0 \in [a, b]$

$$\min_t (u(t) - \alpha(t)) = u(t_0) - \alpha(t_0) < 0.$$

Extending the functions by periodicity, we have then

$$u'(t_0) - D_- \alpha(t_0) \leq 0 \leq u'(t_0) - D^+ \alpha(t_0)$$

and by definition of a lower solution $u'(t_0) - \alpha'(t_0) = 0$. Further, there exists an open interval I_0 , with $t_0 \in I_0$, $\alpha \in W^{2,1}(I_0)$ and for almost every $t \in I_0$

$$\alpha''(t) \geq f(t, \alpha(t)).$$

Hence, for $t \geq t_0$, near enough t_0 ,

$$\begin{aligned} u'(t) - \alpha'(t) &= \int_{t_0}^t (u''(s) - \alpha''(s)) \, ds \\ &\leq \int_{t_0}^t [f(s, \alpha(s)) + u(s) - \alpha(s) - f(s, \alpha(s))] \, ds < 0. \end{aligned}$$

This proves $u(t_0) - \alpha(t_0)$ is not a minimum of $u - \alpha$ which is a contradiction. A similar argument holds to prove $u \leq \beta$. \square

Theorem 1.1 furnishes two kinds of information. It is an existence result but it gives also a localization of the solution. In the following example, such a localization provides an asymptotic estimate on the solution.

EXAMPLE 1.1. Consider the problem

$$\epsilon u'' = (u - |t|)^3, \quad u(-1) = u(1), \quad u'(-1) = u'(1),$$

where $\epsilon > 0$ is a parameter. Let $k = \epsilon^p$ with $p \in]0, 1/4[$,

$$\alpha(t) = 1 - \sqrt{(|t| - 1)^2 + k^2} \quad \text{and} \quad \beta(t) = \sqrt{t^2 + k^2}.$$

If ϵ is small enough, these functions are lower and upper solutions and we deduce from Theorem 1.1 the existence of a solution u such that $\alpha(t) \leq u(t) \leq \beta(t)$ on $[-1, 1]$. This implies an asymptotic estimate

$$u(t) = |t| + O(\epsilon^p).$$

Notice also that in this example $\beta'(-1) \neq \beta'(1)$ and α is not differentiable at $t = 0$.

Another illustration of Theorem 1.1 is the following.

EXAMPLE 1.2. Consider the problem

$$u'' = \frac{1}{\sqrt{t}} u^2 + q(t), \quad u(0) = u(2\pi), \quad u'(0) = u'(2\pi),$$

where $q \in L^1(0, 2\pi)$ is such that

$$\bar{q} + (2\pi)^{3/2} \|\tilde{q}\|_{L^1}^2 \leq 0,$$

with $\bar{q} = \frac{1}{2\pi} \int_0^{2\pi} q(t) \, dt$ and $\tilde{q}(t) = q(t) - \bar{q}$.

Let us prove this problem has a solution u . We define w to be a solution of

$$w'' = \tilde{q}(t), \quad w(0) = w(2\pi), \quad w'(0) = w'(2\pi),$$

and $\alpha(t) = w(t) - w(0)$. Hence, we have $\|\alpha'\|_\infty \leq \|\tilde{q}\|_{L^1}$ and for all $t \in [0, 2\pi]$, $|\alpha(t)| \leq \|\tilde{q}\|_{L^1} t$. We compute then

$$\alpha'' - \frac{1}{\sqrt{t}}\alpha^2 - q(t) \geq -\frac{1}{\sqrt{t}}\|\tilde{q}\|_{L^1}^2 t^2 - \bar{q} \geq -\|\tilde{q}\|_{L^1}^2 (2\pi)^{3/2} - \bar{q} \geq 0,$$

which proves $\alpha(t)$ is a lower solution. If c is a large enough positive constant then $\beta(t) = \alpha(t) + c \geq \alpha(t)$ is an upper solution and existence of a solution follows from Theorem 1.1.

REMARK. Theorem 1.1 depends strongly on the ordering $\alpha \leq \beta$. In case this ordering is not satisfied, the result does not hold as such. Consider for example the following problem.

EXAMPLE 1.3. From Fredholm alternative, it is clear that the problem

$$u'' + u = \sin t, \quad u(0) = u(2\pi), \quad u'(0) = u'(2\pi)$$

has no solution. However

$$\alpha(t) = 1 \quad \text{and} \quad \beta(t) = -1$$

are lower and upper solutions.

REMARK. Another remark of the same type is that the result is no longer true if we allow for α angles with opening from below. This is the case in the following example.

EXAMPLE 1.4. Consider the problem

$$u'' = 1, \quad u(-1) = u(1), \quad u'(-1) = u'(1).$$

It has no solution although $\alpha(t) = t^2 - 1$ is almost a lower solution (i.e., $\alpha''(t) = 2 > 1$, $\alpha(-1) = \alpha(1)$), $\beta(t) = 1$ is an upper solution ($\beta''(t) \leq 1$, $\beta(-1) = \beta(1)$, $\beta'(-1) = \beta'(1)$) and $\alpha(t) < \beta(t)$. Clearly, Theorem 1.1 does not apply here since $D_-\alpha(1) > D^+\alpha(1) = D^+\alpha(-1)$ which means that α is not a lower solution.

In applications it is often useful to use the maximum of lower solutions and the minimum of upper solutions. Although it is probably true, it is not obvious with our definition that such functions are lower and upper solutions. However, we can prove the existence of solutions between such maximum and minimum.

THEOREM 1.2. Let α_i ($i = 1, \dots, n$) be lower solutions and β_j ($j = 1, \dots, m$) be upper solutions of (1.1), $\alpha := \max_{1 \leq i \leq n} \alpha_i$ and $\beta := \min_{1 \leq j \leq m} \beta_j$ be such that $\alpha \leq \beta$. Define E

from (1.2) and let $f : E \rightarrow \mathbb{R}$ be an L^1 -Carathéodory function. Then the problem (1.1) has at least one solution $u \in W^{2,1}(a, b)$ such that for all $t \in [a, b]$

$$\alpha(t) \leq u(t) \leq \beta(t).$$

PROOF. Consider the modified problem

$$u'' - u = \bar{f}(t, u) - \gamma(t, u), \quad u(a) = u(b), \quad u'(a) = u'(b), \tag{1.6}$$

where $\gamma(t, u)$ is defined in (1.4) and

$$\bar{f}(t, u) = \begin{cases} \min_{1 \leq i \leq n} f(t, \max\{\alpha_i(t), u\}), & \text{if } u \leq \alpha(t), \\ f(t, u), & \text{if } \alpha(t) < u < \beta(t), \\ \max_{1 \leq j \leq m} f(t, \min\{\beta_j(t), u\}), & \text{if } \beta(t) \leq u. \end{cases}$$

First, we prove as in Theorem 1.1 that problem (1.6) has a solution. Let us show next that

$$\alpha(t) \leq u(t) \leq \beta(t)$$

on $[a, b]$. Extend α and u by periodicity and assume by contradiction that $\min_t(u(t) - \alpha(t)) < 0$. It follows that, for some t_0 and $i \in \{1, \dots, n\}$, we have $\min_t(u(t) - \alpha(t)) = u(t_0) - \alpha_i(t_0) = \min_t(u(t) - \alpha_i(t)) < 0$. A contradiction follows now as in the proof of Theorem 1.1. Finally, $u \leq \beta$ follows from the same argument. \square

The next result concerns existence of minimal and maximal solutions between lower and upper solutions.

THEOREM 1.3. *Let α and β be lower and upper solutions of (1.1) such that $\alpha \leq \beta$. Define E from (1.2) and let $f : E \rightarrow \mathbb{R}$ satisfy an L^1 -Carathéodory condition. Then the problem (1.1) has a minimal and a maximal solution in $[\alpha, \beta]$, i.e., solutions u_{\min} and u_{\max} such that*

$$\alpha \leq u_{\min} \leq u_{\max} \leq \beta$$

and any other solution u of (1.1) with $\alpha \leq u \leq \beta$ satisfies

$$u_{\min} \leq u \leq u_{\max}.$$

PROOF. Notice first that solutions of (1.1) are fixed points of the operator

$$T : \mathcal{C}([a, b]) \rightarrow \mathcal{C}([a, b])$$

defined by

$$(Tu)(t) = \int_a^b G(t, s)[f(s, u(s)) - u(s)] ds,$$

where $G(t, s)$ is the Green's function of (1.5). Define then the set

$$S = \{u \mid u = Tu, \alpha \leq u \leq \beta\}.$$

From Theorem 1.1, $S \neq \emptyset$. Further S is compact as T is completely continuous. Consider next the family of sets

$$F_x = \{u \in S \mid u \leq x\},$$

where $x \in S$. This family has the finite intersection property as follows from Theorem 1.2. Hence, it is known (see [60, Theorem 5.1]) that there exists

$$u_{\min} \in \bigcap_{x \in S} F_x,$$

which is a minimal solution.

Similarly, we prove existence of a maximal solution. □

The structure of the set of solutions is richer if f is nondecreasing with respect to u . In such a case, we have a continuum of solutions as follows from the following theorem.

THEOREM 1.4. *Assume the hypotheses of Theorem 1.3 hold and f is nondecreasing with respect to u . Then the set of solutions u of (1.1) with $u_{\min} \leq u \leq u_{\max}$ is such that for any $t_0 \in [a, b]$ and $u^* \in [u_{\min}(t_0), u_{\max}(t_0)]$ there exists one of them with $u(t_0) = u^*$.*

PROOF. Let $t_0 \in [a, b]$ and u^* be such that $u_{\min}(t_0) \leq u^* \leq u_{\max}(t_0)$. Choose $\epsilon > 0$ large enough so that $u_{\max} - \epsilon \leq u_{\min} + \epsilon$ and define

$$\alpha_1(t) = \max\{u_{\min}(t), u_{\max}(t) - \epsilon\}, \quad \beta_1(t) = \min\{u_{\max}(t), u_{\min}(t) + \epsilon\}.$$

Observe that $u_{\max} - \epsilon$ and $u_{\min} + \epsilon$ are respectively lower and upper solutions of (1.1). By Theorem 1.2, the problem (1.1) has a solution u_1 such that, for all $t \in [a, b]$,

$$u_{\min}(t) \leq u_1(t) \leq u_{\min}(t) + \epsilon, \quad u_{\max}(t) - \epsilon \leq u_1(t) \leq u_{\max}(t).$$

In case $u^* \in [u_{\min}(t_0), u_1(t_0)]$ we define

$$\alpha_2(t) = \max\{u_{\min}(t), u_1(t) - \epsilon/2\}, \quad \beta_2(t) = \min\{u_1(t), u_{\min}(t) + \epsilon/2\}$$

and obtain from Theorem 1.2 a solution u_2 such that on $[a, b]$

$$u_{\min}(t) \leq u_2(t) \leq u_{\min}(t) + \epsilon/2, \quad u_1(t) - \epsilon/2 \leq u_2(t) \leq u_1(t).$$

If $u^* \in [u_1(t_0), u_{\max}(t_0)]$, we proceed in a similar way. This defines a sequence of solutions $(u_k)_k$ that satisfies $|u_k(t_0) - u^*| \leq \epsilon/2^{k-1}$. Next, from Arzelà–Ascoli theorem, there is a

subsequence $(u_{k_n})_n$ such that, for some $u \in \mathcal{C}([a, b])$, u_{k_n} converges to u in $\mathcal{C}([a, b])$. It follows then that u is a solution of (1.1). Further, we have $u(t_0) = \lim_{n \rightarrow \infty} u_{k_n}(t_0) = u^*$. \square

Existence of a continuum of solutions depends strongly on the nondecreasingness of f . Such a continuum does not exist in the following example.

EXAMPLE 1.5. Consider the problem

$$\begin{aligned} u'' &= u^3 - u^2, \\ u(0) &= u(T), \quad u'(0) = u'(T). \end{aligned}$$

Notice first that $\alpha(t) = -2$ and $\beta(t) = 2$ are lower and upper solutions. Also, it is straightforward from a phase plane analysis that this problem has only two solutions, $u_1 = 0$ and $u_2 = 1$, which are between α and β .

Notice also that solutions between lower and upper solutions are not necessarily ordered as shown in the example that follows.

EXAMPLE 1.6. The piecewise linear problem

$$\begin{aligned} u'' &= \min\{u + 2, \max\{-u, u - 2\}\}, \\ u(0) &= u(2\pi), \quad u'(0) = u'(2\pi), \end{aligned}$$

is such that $u_1(t) = \sin t$ and $u_2(t) = -\sin t$ are nonordered solutions which lie between the lower solution $\alpha(t) = -3$ and the upper one $\beta(t) = 3$. In this problem, it follows from the phase plane analysis that the minimal and maximal solutions are respectively $u_{\min}(t) = -2$ and $u_{\max}(t) = 2$.

1.2. A priori bounds on the derivatives

Consider the problem

$$u'' = f(t, u, u'), \quad u(a) = u(b), \quad u'(a) = u'(b). \quad (1.7)$$

Here the Nemitskii operator reads $N(u) := f(\cdot, u, u')$ and therefore the fixed point problem associated to (1.7) is defined now on $\mathcal{C}^1([a, b])$. Lower and upper solutions will give a priori bounds on u . In order to apply the Schauder Fixed Point theorem or degree theory we shall also need a priori bounds on the derivative u' . In some cases, the special structure of the nonlinearity f gives this information. In others, this follows from a Nagumo condition. The following example shows that in any case some condition is necessary since the existence of solutions does not follow from the existence of ordered lower and upper solutions.

EXAMPLE 1.7. Consider the problem

$$u'' = (1 + u'^2)^2(u - p(t)), \quad u(0) = u(T), \quad u'(0) = u'(T), \tag{1.8}$$

where p is a continuous function such that $p(t) = 2$ on $[0, T/3[$, $p(t) \in [-2, 2]$ on $[T/3, 2T/3[$ and $p(t) = -2$ on $[2T/3, T]$. For such a problem we define lower and upper solutions from Definitions 1.2 below. It follows that $\alpha = -3$ is a lower solution and $\beta = 3$ an upper one. However, it can be proved using elementary methods that if $T > 0$ is large enough, (1.8) has no solution (see [33,50]).

To illustrate how a priori bounds on the derivative can follow from the structure of the equation, consider the periodic problem for a Rayleigh equation

$$u'' + g(u') + h(t, u) = 0, \quad u(a) = u(b), \quad u'(a) = u'(b). \tag{1.9}$$

PROPOSITION 1.5. *Let $h : [a, b] \times [-r, r] \rightarrow \mathbb{R}$ be a Carathéodory function such that for some $h_0 \in L^2(a, b)$, for a.e. $t \in [a, b]$ and all $u \in [-r, r]$, we have $|h(t, u)| \leq h_0(t)$. Then there exists $R > 0$ such that for every function $g \in \mathcal{C}(\mathbb{R})$, any solution u of (1.9) with $\|u\|_\infty \leq r$ satisfies $\|u'\|_\infty < R$.*

PROOF. Define $R := \sqrt{b-a} \|h_0\|_{L^2} + 1 > 0$. Let then $g \in \mathcal{C}(\mathbb{R})$ be given and u be a solution of (1.9) with $\|u\|_\infty \leq r$. Multiplying (1.9) by u'' and integrating we obtain

$$\|u''\|_{L^2}^2 = - \int_a^b g(u'(t))u''(t) dt - \int_a^b h(t, u(t))u''(t) dt \leq \|h_0\|_{L^2} \|u''\|_{L^2}.$$

Now it is easy to see that for some $t_0 \in [a, b]$, $u'(t_0) = 0$ so that for all $t \in [a, b]$

$$|u'(t)| = \left| \int_{t_0}^t u''(s) ds \right| \leq \sqrt{b-a} \|h_0\|_{L^2} < R.$$

□

In case the equation does not have any special structure, a priori bounds on the derivative can still be obtained for nonlinearities which do not grow too quickly with respect to the derivative. For continuous functions, Nagumo conditions describe such a control. A typical result is the following.

PROPOSITION 1.6. *Let $E \subset [a, b] \times [-r, r] \times \mathbb{R}$ and let $\bar{\varphi} : \mathbb{R}^+ \rightarrow \mathbb{R}_0^+$ be a continuous function that satisfies*

$$\int_0^\infty \frac{s ds}{\bar{\varphi}(s)} = +\infty. \tag{1.10}$$

Then there exists $R > 0$ such that for every continuous function $f : E \rightarrow \mathbb{R}$ that satisfies

$$\forall (t, u, v) \in E, \quad |f(t, u, v)| \leq \bar{\varphi}(|v|) \tag{1.11}$$

and every solution u of

$$u'' = f(t, u, u') \tag{1.12}$$

such that $\|u\|_\infty \leq r$, we have $\|u'\|_\infty < R$.

REMARK. A function $f : E \rightarrow \mathbb{R}$ is said to satisfy a Nagumo condition if (1.11) holds.

PROOF. Define $R > 0$ to be such that

$$\int_{2r/(b-a)}^R \frac{s \, ds}{\bar{\varphi}(s)} > 2r \tag{1.13}$$

and let u be a solution of (1.12) such that $(t, u(t), u'(t)) \in E$ on $[a, b]$. Observe that there exists $\tau \in [a, b]$ with $|u'(\tau)| \leq 2r/(b-a)$. Assume now there exists an interval $I = [t_0, t_1]$ (or $[t_1, t_0]$) such that $u'(t_0) = 2r/(b-a)$, $u'(t_1) = R$ and $u'(t) \in [2r/(b-a), R]$ on I . We have then

$$\begin{aligned} \int_{u'(t_0)}^{u'(t_1)} \frac{s \, ds}{\bar{\varphi}(s)} &= \int_{t_0}^{t_1} \frac{u'(t)u''(t)}{\bar{\varphi}(u'(t))} \, dt = \int_{t_0}^{t_1} \frac{u'(t)f(t, u(t), u'(t))}{\bar{\varphi}(u'(t))} \, dt \\ &\leq |u(t_1) - u(t_0)| \leq 2r, \end{aligned}$$

which contradicts (1.13).

In the same way, we prove that, for any $t \in [a, b]$, $u'(t) > -R$ and the result follows. \square

REMARKS. In the above proof we do not use the divergence of the integral in (1.10) but rather the fact that for some $R > 0$,

$$\int_{\frac{2r}{b-a}}^R \frac{s \, ds}{\bar{\varphi}(s)} > 2r.$$

In case $\varphi(s) = 1 + s^p$, condition (1.10) implies that $p \leq 2$. However this condition still holds if $\varphi(s) = s^2 \ln(s^2 + 1) + 1$.

A fundamental generalization of this result concerns one-sided Nagumo conditions. This applies to problems where some a priori bound on the derivative of solutions is known at the points a and b . For the periodic problem we can extend the solution by periodicity and consider an interval $[\bar{a}, \bar{a} + b - a]$ so that $u'(\bar{a}) = u'(\bar{a} + b - a) = 0$.

PROPOSITION 1.7. Let $E \subset [\bar{a}, \bar{b}] \times [-r, r] \times \mathbb{R}$, $k \geq 0$ and let $\bar{\varphi} : \mathbb{R}^+ \rightarrow \mathbb{R}_0^+$ be a continuous function that satisfies (1.10). Then there exists $R > 0$ such that for every continuous function $f : E \rightarrow \mathbb{R}$ that satisfies

$$\forall (t, u, v) \in E, \quad f(t, u, v) \leq \bar{\varphi}(|v|) \tag{1.14}$$

and for every solution u of (1.12) on $[\bar{a}, \bar{b}]$ such that $\|u\|_\infty \leq r$, $u'(\bar{a}) \leq k$ and $u'(\bar{b}) \geq -k$, we have $\|u'\|_\infty < R$.

PROOF. The proof follows the argument of the proof of Proposition 1.6. \square

REMARK. Condition (1.14) is called a *one-sided Nagumo condition*.

The above result still holds for other such conditions. We can consider any of the following:

- (a) $f(t, u, v) \geq -\bar{\varphi}(|v|)$ for all $(t, u, v) \in E$, $u'(\bar{a}) \geq -k$ and $u'(\bar{b}) \leq k$;
- (b) $\text{sgn}(v)f(t, u, v) \leq \bar{\varphi}(|v|)$ for all $(t, u, v) \in E$ and $|u'(\bar{a})| \leq k$;
- (c) $\text{sgn}(v)f(t, u, v) \geq -\bar{\varphi}(|v|)$ for all $(t, u, v) \in E$ and $|u'(\bar{b})| \leq k$.

Such assumptions apply for problems of the type

$$u'' \pm (2 + \sin t)(u')^m + h(t, u) = 0, \quad u(a) = u(b), \quad u'(a) = u'(b),$$

with $m \geq 0$.

The Nagumo condition implies the function f at hand is L^∞ -Carathéodory. Hence this condition has to be extended so as to deal with L^p -Carathéodory functions which are not L^∞ -Carathéodory.

PROPOSITION 1.8. Let $E \subset [a, b] \times [-r, r] \times \mathbb{R}$, $p, q \in [1, \infty]$ with $\frac{1}{p} + \frac{1}{q} = 1$ and $\bar{\psi} \in L^p(a, b)$. Let also $\bar{\varphi}: \mathbb{R}^+ \rightarrow \mathbb{R}_0^+$ be a continuous function that satisfies

$$\int_0^{+\infty} \frac{s^{1/q}}{\bar{\varphi}(s)} ds = +\infty. \quad (1.15)$$

Then, there exists $R > 0$ so that for every Carathéodory function $f: E \rightarrow \mathbb{R}$ such that

$$\begin{aligned} &\text{for a.e. } t \in [a, b] \text{ and all } (u, v) \in \mathbb{R}^2, \text{ with } (t, u, v) \in E, \\ &|f(t, u, v)| \leq \bar{\psi}(t)\bar{\varphi}(|v|), \end{aligned} \quad (1.16)$$

and for every solution u of (1.12) such that $\|u\|_\infty \leq r$, we have

$$\|u'\|_\infty < R.$$

PROOF. Define $R > 0$ to be such that

$$\int_{2r/(b-a)}^R \frac{s^{1/q}}{\bar{\varphi}(s)} ds > \|\bar{\psi}\|_{L^p} (2r)^{1/q}.$$

Let u be a solution of (1.12) and $t \in [a, b]$ be such that $u'(t) \geq R$. We can choose, as in the proof of Proposition 1.6, $t_0 < t_1$ (or $t_0 > t_1$) such that $u'(t_0) = 2r/(b-a)$, $u'(t_1) = R$ and

$u'(t) \in [2r/(b - a), R]$ on $[t_0, t_1]$ (or $[t_1, t_0]$). Next, we write

$$\begin{aligned} \int_{u'(t_0)}^{u'(t_1)} \frac{s^{1/q}}{\bar{\varphi}(s)} ds &= \int_{t_0}^{t_1} \frac{(u')^{1/q}(t)u''(t)}{\bar{\varphi}(u'(t))} dt \\ &= \int_{t_0}^{t_1} \frac{(u')^{1/q}(t)f(t, u(t), u'(t))}{\bar{\varphi}(u'(t))} dt \\ &\leq \left| \int_{t_0}^{t_1} \bar{\psi}(t)(u')^{1/q}(t) dt \right| \leq \|\bar{\psi}\|_{L^p} \left| \int_{t_0}^{t_1} u'(t) dt \right|^{1/q} \\ &\leq \|\bar{\psi}\|_{L^p} (2r)^{1/q}. \end{aligned}$$

We obtain a contradiction and deduce that $u'(t) < R$ on $[a, b]$. In the same way we prove that $u'(t) > -R$ on $[a, b]$. □

Assumption (1.16) is a Nagumo condition. Similar one-sided conditions can also be worked out for the Carathéodory case.

PROPOSITION 1.9. *Let $E \subset [\bar{a}, \bar{b}] \times [-r, r] \times \mathbb{R}$, $k \geq 0$, $p, q \in [1, \infty]$ with $\frac{1}{p} + \frac{1}{q} = 1$ and $\bar{\psi} \in L^p(a, b)$. Let also $\bar{\varphi}: \mathbb{R}^+ \rightarrow \mathbb{R}_0^+$ be a continuous function that satisfies (1.15). Then, there exists $R > 0$ so that for every L^p -Carathéodory function $f: E \rightarrow \mathbb{R}$ such that*

$$\begin{aligned} &\text{for a.e. } t \in [a, b] \text{ and all } (u, v) \in \mathbb{R}^2, \text{ with } (t, u, v) \in E, \\ &f(t, u, v) \leq \bar{\psi}(t)\bar{\varphi}(|v|), \end{aligned} \tag{1.17}$$

and for every solution u of (1.12) such that $\|u\|_\infty \leq r$, $u'(\bar{a}) \leq k$ and $u'(\bar{b}) \geq -k$, we have

$$\|u'\|_\infty < R.$$

PROOF. The proof follows the line of the proof of Proposition 1.8. □

REMARK. Similar results hold for the other one-sided Nagumo conditions as in the remark following Proposition 1.7.

1.3. Derivative dependent periodic problems

Definitions of lower and upper solutions for the periodic problem (1.7) are straightforward extensions of Definitions 1.1.

DEFINITIONS 1.2. A function $\alpha \in \mathcal{C}([a, b])$ such that $\alpha(a) = \alpha(b)$ is a *lower solution* of (1.7) if its periodic extension on \mathbb{R} is such that for any $t_0 \in \mathbb{R}$ either $D_-\alpha(t_0) < D^+\alpha(t_0)$, or there exists an open interval I_0 such that $t_0 \in I_0$, $\alpha \in W^{2,1}(I_0)$ and, for a.e. $t \in I_0$,

$$\alpha''(t) \geq f(t, \alpha(t), \alpha'(t)).$$

A function $\beta \in C([a, b])$ such that $\beta(a) = \beta(b)$ is an *upper solution* of (1.7) if its periodic extension on \mathbb{R} is such that for any $t_0 \in \mathbb{R}$ either $D^-\beta(t_0) > D_+\beta(t_0)$, or there exists an open interval I_0 such that $t_0 \in I_0$, $\beta \in W^{2,1}(I_0)$ and, for a.e. $t \in I_0$,

$$\beta''(t) \leq f(t, \beta(t), \beta'(t)).$$

As a first result we consider periodic solutions of the Rayleigh equation.

THEOREM 1.10. *Let $\alpha, \beta \in C([a, b])$ be lower and upper solutions of the problem (1.9) such that $\alpha \leq \beta$. Let E be defined by (1.2), $g \in C(\mathbb{R})$ and let $h : E \rightarrow \mathbb{R}$ be an L^2 -Carathéodory function. Then problem (1.9) has at least one solution $u \in W^{2,2}(a, b)$ such that for all $t \in [a, b]$*

$$\alpha(t) \leq u(t) \leq \beta(t).$$

PROOF. Consider the family of modified problems

$$\begin{aligned} u'' - C(t)u &= -[\lambda g(u') + h(t, \gamma(t, u)) + C(t)\gamma(t, u)], \\ u(a) &= u(b), \quad u'(a) = u'(b), \end{aligned} \tag{1.18}$$

where $\gamma(t, u)$ is defined from (1.4), $C \in L^1(a, b)$ is chosen such that $C(t) > |g(0)| + 1 + |h(t, u)|$ for $(t, u) \in E$ and $\lambda \in [0, 1]$.

Claim 1. Define $\rho = \max\{\|\alpha\|_\infty, \|\beta\|_\infty\} + 1$. Then every solution u of (1.18) satisfies $\|u\|_\infty < \rho$. Let us assume on the contrary that for some $t_0 \in \mathbb{R}$

$$\min_t u(t) = u(t_0) \leq -\rho.$$

Hence $u'(t_0) = 0$ and we compute for $t \geq t_0$ close enough to t_0

$$\begin{aligned} u'(t) &= \int_{t_0}^t u''(s) \, ds \\ &\leq \int_{t_0}^t [C(s)(u(s) - \alpha(s)) - \lambda g(u'(s)) - h(s, \alpha(s))] \, ds \\ &\leq - \int_{t_0}^t [C(s) - |g(u'(s))| - h(s, \alpha(s))] \, ds < 0. \end{aligned}$$

This proves that $u(t_0)$ is not a minimum of u which is a contradiction. A similar argument holds to prove that $u \leq \rho$.

Claim 2. There exists $R > 0$ such that every solution u of (1.18) with $\|u\|_\infty < \rho$ satisfies $\|u'\|_\infty < R$. The proof follows the argument in Proposition 1.5.

Claim 3. There exists a solution u of (1.18) with $\lambda = 1$. Define the operator $T_\lambda : C^1([a, b]) \rightarrow C^1([a, b])$ by

$$T_\lambda(u) = - \int_a^b G(t, s) [\lambda g(u'(s)) + h(s, \gamma(s, u(s))) + C(s)\gamma(s, u(s))] \, ds,$$

where $G(t, s)$ is the Green's function of

$$\begin{aligned} u'' - C(t)u &= f(t), \\ u(a) &= u(b), \quad u'(a) = u'(b). \end{aligned}$$

Observe that there exists $R_0 > 0$ such that $T_0(\mathcal{C}^1([a, b])) \subset B(0, R_0)$. Hence,

$$\deg(I - T_0, B(0, R_0)) = 1$$

and by the properties of the degree, we prove easily that (1.18) with $\lambda = 1$ has a solution.

Claim 4. The solution u of (1.18) with $\lambda = 1$ is such that $\alpha(t) \leq u(t) \leq \beta(t)$ on $[a, b]$. Extend α and u by periodicity. Let $t_0 \in [a, b[$ be such that

$$u(t_0) - \alpha(t_0) = \min_t (u(t) - \alpha(t)) < 0.$$

From the definition of lower solution there exists an open interval I_0 such that $t_0 \in I_0$, $\alpha \in W^{2,1}(I_0)$ and, for a.e. $t \in I_0$,

$$\alpha''(t) + g(\alpha'(t)) + h(t, \alpha(t)) \geq 0.$$

Further, for $t \geq t_0$ near enough t_0 , we compute

$$\begin{aligned} u'(t) - \alpha'(t) &= \int_{t_0}^t (u''(s) - \alpha''(s)) \, ds \\ &\leq \int_{t_0}^t [g(\alpha'(s)) - g(u'(s)) + C(s)(u(s) - \alpha(s))] \, ds < 0, \end{aligned}$$

which follows as $g(\alpha'(s)) - g(u'(s))$ is small and $C(s)(\alpha(s) - u(s)) > \alpha(s) - u(s) \geq k$ for some $k > 0$. This contradicts the minimality of $u - \alpha$ at t_0 .

In a similar way we prove that $u \leq \beta$. Hence u is also a solution of (1.18). \square

A similar result is easy to work out for the general problem (1.7) in case a one-sided Nagumo condition is satisfied. Here we work the case of a continuous function f . The key of the proof of this generalization is to use an appropriate modified problem.

THEOREM 1.11. Let $\alpha, \beta \in \mathcal{C}([a, b])$ be lower and upper solutions of the problem (1.7) such that $\alpha \leq \beta$. Let

$$E = \{(t, u, v) \in [a, b] \times \mathbb{R}^2 \mid \alpha(t) \leq u \leq \beta(t)\}, \tag{1.19}$$

$\varphi: \mathbb{R}^+ \rightarrow \mathbb{R}$ be a positive continuous function satisfying (1.10) and $f: E \rightarrow \mathbb{R}$ a continuous function which satisfies the one-sided Nagumo condition (1.14) (with $\bar{\varphi} = \varphi$). Then the problem (1.7) has at least one solution $u \in \mathcal{C}^2([a, b])$ such that for all $t \in [a, b]$

$$\alpha(t) \leq u(t) \leq \beta(t).$$

PROOF. Consider the modified problem

$$\begin{aligned} u'' &= \lambda f(t, \gamma(t, u), u') + \varphi(|u'|)(u - \lambda\gamma(t, u)), \\ u(a) &= u(b), \quad u'(a) = u'(b), \end{aligned} \tag{1.20}$$

where $\gamma(t, u)$ is defined by (1.4). Choose $r > 0$ such that

$$\begin{aligned} -r &< \alpha(t) \leq \beta(t) < r, \\ f(t, \alpha(t), 0) + \varphi(0)(-r - \alpha(t)) &< 0, \\ f(t, \beta(t), 0) + \varphi(0)(r - \beta(t)) &> 0. \end{aligned}$$

Claim 1. Every solution u of (1.20) with $\lambda \in [0, 1]$ is such that $-r < u(t) < r$. Assume there exists t_0 such that $u(t_0) = \min_t u(t) \leq -r$. This leads to a contradiction since then

$$0 \leq u''(t_0) = \lambda[f(t_0, \alpha(t_0), 0) + \varphi(0)(u(t_0) - \alpha(t_0))] + (1 - \lambda)\varphi(0)u(t_0) < 0.$$

Similarly, we prove that $u(t) < r$.

Claim 2. There exists $R > 0$ such that every solution u of (1.20) with $\lambda \in [0, 1]$ satisfies $\|u'\|_\infty < R$. The claim follows choosing $R > 0$ from Proposition 1.7, where $\bar{\varphi}(v) = (1 + 2r)\varphi(v)$, $k = 0$ and \bar{a} is such that $u'(\bar{a}) = u'(\bar{a} + b - a) = 0$.

Claim 3. Existence of solutions of (1.20) for $\lambda = 1$. Let us define the operators

$$\begin{aligned} L : \text{Dom } L \subset C^1([a, b]) &\rightarrow C([a, b]) : u \rightarrow u'' - u, \\ N_\lambda : C^1([a, b]) &\rightarrow C([a, b]) : u \rightarrow \lambda f(t, \gamma(t, u), u') + \varphi(|u'|)(u - \lambda\gamma(t, u)) - u, \end{aligned}$$

where $\text{Dom } L = \{u \in C^2([a, b]) \mid u(a) = u(b), u'(a) = u'(b)\}$. Observe that L has a compact inverse. Hence, we can define the completely continuous operator

$$T_\lambda(u) = L^{-1}N_\lambda(u).$$

From degree theory, we have that

$$\deg(T_0, \Omega) = \deg(T_1, \Omega),$$

where

$$\Omega = \{u \in C^1([a, b]) \mid \|u\|_\infty < r, \|u'\|_\infty < R\}.$$

Using the Odd Mapping theorem (see [69]), we compute that

$$\deg(T_0, \Omega) \neq 0$$

and the problem (1.20) with $\lambda = 1$ has a solution u .

Claim 4. The solution u of (1.20) with $\lambda = 1$ is such that $\alpha \leq u \leq \beta$. This claim follows as the corresponding argument in the proof of Theorem 1.10. As a consequence, u satisfies (1.7). \square

The following theorem considers the case of L^p -Carathéodory nonlinearities.

THEOREM 1.12. Let α and $\beta \in C([a, b])$ be lower and upper solutions of (1.7) such that $\alpha \leq \beta$. Define $A \subset [a, b]$ (respectively $B \subset [a, b]$) to be the set of points where α (respectively β) is differentiable. Let $p, q \in [1, \infty]$ with $\frac{1}{p} + \frac{1}{q} = 1$, $\psi \in L^p(a, b)$ and $\varphi \in C(\mathbb{R}^+, \mathbb{R}_0^+)$ be such that (1.15) holds (with $\bar{\varphi} = \varphi$). Let E be defined from (1.19) and suppose $f : E \rightarrow \mathbb{R}$ is an L^p -Carathéodory function that satisfies the one-sided Nagumo condition (1.17) (with $\bar{\varphi} = \varphi$ and $\bar{\psi} = \psi$). Assume there exists $N \in L^1(a, b)$, $N > 0$, such that for a.e. $t \in A$ (respectively for a.e. $t \in B$)

$$f(t, \alpha(t), \alpha'(t)) \geq -N(t) \quad (\text{respectively } f(t, \beta(t), \beta'(t)) \leq N(t)). \quad (1.21)$$

Then the problem (1.7) has at least one solution $u \in W^{2,p}(a, b)$ such that for all $t \in [a, b]$

$$\alpha(t) \leq u(t) \leq \beta(t).$$

PROOF. The proof proceeds in several steps.

Step 1. The modified problem. Let $R > 0$ be large enough so that

$$\int_0^R \frac{s^{1/q}}{\varphi(s)} ds > \|\psi\|_{L^p} (\max_t \beta(t) - \min_t \alpha(t))^{1/q}.$$

Increasing N if necessary, we can assume $N(t) \geq |f(t, u, v)|$ if $t \in [a, b]$, $\alpha(t) \leq u \leq \beta(t)$ and $|v| \leq R$. Define then

$$\begin{aligned} \bar{f}(t, u, v) &= \max\{\min\{f(t, \gamma(t, u), v), N(t)\}, -N(t)\}, \\ \omega_1(t, \delta) &= \chi_A(t) \max_{|v| \leq \delta} |\bar{f}(t, \alpha(t), \alpha'(t) + v) - \bar{f}(t, \alpha(t), \alpha'(t))|, \\ \omega_2(t, \delta) &= \chi_B(t) \max_{|v| \leq \delta} |\bar{f}(t, \beta(t), \beta'(t) + v) - \bar{f}(t, \beta(t), \beta'(t))|, \end{aligned}$$

where γ is defined from (1.4), χ_A and χ_B are the characteristic functions of the sets A and B . It is clear that ω_i are L^1 -Carathéodory functions, nondecreasing in δ , such that $\omega_i(t, 0) = 0$ and $|\omega_i(t, \delta)| \leq 2N(t)$.

We consider now the modified problem

$$u'' - u = \bar{f}(t, u, u') - \omega(t, u), \quad u(a) = u(b), \quad u'(a) = u'(b), \quad (1.22)$$

where

$$\omega(t, u) = \begin{cases} \beta(t) - \omega_2(t, u - \beta(t)), & \text{if } u > \beta(t), \\ u, & \text{if } \alpha(t) \leq u \leq \beta(t), \\ \alpha(t) + \omega_1(t, \alpha(t) - u), & \text{if } u < \alpha(t). \end{cases}$$

Step 2. Existence of a solution of (1.22). This claim follows from Schauder's theorem.

Step 3. The solution u of (1.22) is such that $\alpha \leq u \leq \beta$. Let us assume on the contrary that for some $t_0 \in \mathbb{R}$

$$\min_t (u(t) - \alpha(t)) = u(t_0) - \alpha(t_0) < 0.$$

Then, as in Theorem 1.1, there exists an open interval I_0 with $t_0 \in I_0$, $\alpha \in W^{2,1}(I_0)$ and, for a.e. $t \in I_0$

$$\alpha''(t) \geq f(t, \alpha(t), \alpha'(t)).$$

Further $u'(t_0) - \alpha'(t_0) = 0$ and for $t \geq t_0$ near enough t_0

$$|u'(t) - \alpha'(t)| \leq \alpha(t) - u(t).$$

As ω_1 is nondecreasing and $\bar{f}(t, \alpha(t), \alpha'(t)) \leq f(t, \alpha(t), \alpha'(t))$,

$$\begin{aligned} u'(t) - \alpha'(t) &= \int_{t_0}^t (u''(s) - \alpha''(s)) \, ds \\ &\leq \int_{t_0}^t [\bar{f}(s, \alpha(s), u'(s)) - \bar{f}(s, \alpha(s), \alpha'(s)) \\ &\quad + u(s) - \alpha(s) - \omega_1(s, \alpha(s) - u(s))] \, ds < 0. \end{aligned}$$

This proves $u(t_0) - \alpha(t_0)$ is not a minimum of $u - \alpha$ which is a contradiction.

A similar argument holds to prove $u \leq \beta$.

Step 4. The solution u of (1.22) is such that $\|u'\|_\infty < R$. Observe that, for all $(t, u, v) \in E$,

$$\max\{\min\{f(t, u, v), N(t)\}, -N(t)\} \leq \psi(t)\varphi(|v|).$$

From Proposition 1.9, every solution $u \in [\alpha, \beta]$ of (1.22) satisfies

$$\|u'\|_\infty < R.$$

Hence $|f(t, u(t), u'(t))| \leq N(t)$ and the function u is a solution of (1.7). □

REMARK. Notice that the condition (1.21) is satisfied in case f does not depend on u' or if $\alpha, \beta \in W^{1,\infty}(a, b)$.

EXAMPLE 1.8. Existence of a solution to problem

$$u'' = \frac{1}{\sqrt{t}}|u'|^a + u + t, \quad u(0) = u(1), \quad u'(0) = u'(1),$$

where $1 \leq a < 3/2$, follows from Theorem 1.12. Notice that here Theorem 1.11 does not apply.

1.4. Derivative dependent Dirichlet problem

Dirichlet boundary value problems

$$u'' = f(t, u, u'), \quad u(a) = 0, \quad u(b) = 0, \tag{1.23}$$

can be studied in a similar way. To this end, we adapt accordingly the definitions of lower and upper solutions.

DEFINITIONS 1.3. A function $\alpha \in C([a, b])$ is a *lower solution* of (1.23) if

(a) for any $t_0 \in]a, b[$, either $D_-\alpha(t_0) < D^+\alpha(t_0)$, or there exists an open interval $I_0 \subset]a, b[$ such that $t_0 \in I_0$, $\alpha \in W^{2,1}(I_0)$ and, for a.e. $t \in I_0$,

$$\alpha''(t) \geq f(t, \alpha(t), \alpha'(t));$$

(b) $\alpha(a) \leq 0, \alpha(b) \leq 0$.

A function $\beta \in C([a, b])$ is an *upper solution* of (1.23) if

(a) for any $t_0 \in]a, b[$, either $D_-\beta(t_0) > D_+\beta(t_0)$, or there exists an open interval $I_0 \subset]a, b[$ such that $t_0 \in I_0$, $\beta \in W^{2,1}(I_0)$ and, for a.e. $t \in I_0$,

$$\beta''(t) \leq f(t, \beta(t), \beta'(t));$$

(b) $\beta(a) \geq 0, \beta(b) \geq 0$.

A typical result is then the following.

THEOREM 1.13. Assume α and $\beta \in C([a, b])$ are lower and upper solutions of problem (1.23) such that $\alpha \leq \beta$. Define $A \subset [a, b]$ (respectively $B \subset [a, b]$) to be the set of points where α (respectively β) is derivable. Let $p, q \in [1, \infty]$ with $\frac{1}{p} + \frac{1}{q} = 1$, $\varphi \in C(\mathbb{R}^+, \mathbb{R}_0^+)$ and $\psi \in L^p(a, b)$ be such that (1.15) holds (with $\bar{\varphi} = \varphi$). Let E be defined in (1.19) and suppose $f : E \rightarrow \mathbb{R}$ is an L^p -Carathéodory function that satisfies the Nagumo condition (1.16) (with $\bar{\varphi} = \varphi$ and $\bar{\psi} = \psi$). Assume there exists $N \in L^1(a, b)$, $N > 0$ such that, for a.e. $t \in A$ (respectively for a.e. $t \in B$),

$$f(t, \alpha(t), \alpha'(t)) \geq -N(t) \quad (\text{respectively } f(t, \beta(t), \beta'(t)) \leq N(t)).$$

Then the problem (1.23) has at least one solution $u \in W^{2,p}(a, b)$ such that for all $t \in [a, b]$

$$\alpha(t) \leq u(t) \leq \beta(t).$$

PROOF. The proof of this result follows the lines of the proof of Theorem 1.12 and is left to the reader as an exercise. \square

Notice that a similar result using one-sided Nagumo conditions can be worked out provided some a priori bound on the derivative of solutions is known at the points a and b (see Proposition 1.7). These a priori bounds are valid, for example, in case the lower or the upper solution satisfies the boundary conditions.

1.5. A derivative independent Dirichlet problem

Dirichlet boundary value problems

$$u'' = f(t, u), \quad u(a) = 0, \quad u(b) = 0, \quad (1.24)$$

can be studied for more general nonlinearities than L^1 -Carathéodory functions. For example, the problem

$$t(1-t)u'' = 1, \quad u(0) = 0, \quad u(1) = 0,$$

has the solution $u(t) = t \ln t + (1-t) \ln(1-t)$ which is in $C_0([0, 1]) \cap W_{loc}^{2,1}([0, 1])$ but not even in $C^1([0, 1])$. This generalizes to the linear problem

$$u'' = h(t), \quad u(a) = 0, \quad u(b) = 0. \quad (1.25)$$

In case

$$h \in \mathcal{A} := \{h \mid (s-a)(b-s)h(s) \in L^1(a, b)\},$$

problem (1.25) has one and only one solution in

$$W^{2,\mathcal{A}}(a, b) := \{u \in W^{1,1}(a, b) \mid u'' \in \mathcal{A}\} \subset C([a, b]) \cap C^1(]a, b[),$$

which reads

$$u(t) = \int_a^b G(t, s)h(s) \, ds,$$

where $G(t, s)$ is the corresponding Green's function. Further, we have

$$\|u\|_\infty \leq \frac{1}{b-a} \|h\|_{\mathcal{A}},$$

where $\|h\|_{\mathcal{A}} = \int_a^b (s-a)(b-s)|h(s)| \, ds$ (see [53,33]).

In order to deal with nonlinear problems, we consider \mathcal{A} -Carathéodory functions $f: E \subset [a, b] \times \mathbb{R} \rightarrow \mathbb{R}$. These are Carathéodory functions such that for any $r > 0$

there exists $h \in \mathcal{A}$ so that for a.e. $t \in [a, b]$ and all $u \in \mathbb{R}$ with $(t, u) \in E$ and $|u| \leq r$, $|f(t, u)| \leq h(t)$.

Notice that if $g : \mathbb{R} \rightarrow \mathbb{R}$ is continuous, the function

$$f(t, u) = \frac{g(u)}{t(1-t)}$$

is an \mathcal{A} -Carathéodory function. Observe also that $L^1(a, b) \subset \mathcal{A}$, so that this definition generalizes the classical L^1 -Carathéodory conditions on f .

We can now state the main result for (1.24).

THEOREM 1.14. *Assume that α and β are lower and upper solutions of (1.24) such that $\alpha \leq \beta$. Let E be defined from (1.2) and $f : E \rightarrow \mathbb{R}$ be an \mathcal{A} -Carathéodory function. Then the problem (1.24) has at least one solution $u \in W^{2,\mathcal{A}}(a, b)$ such that for all $t \in [a, b]$*

$$\alpha(t) \leq u(t) \leq \beta(t).$$

PROOF. We consider the modified problem

$$u'' - u = f(t, \gamma(t, u)) - \gamma(t, u), \quad u(a) = 0, \quad u(b) = 0, \tag{1.26}$$

where γ is defined by (1.4).

Claim 1. *The problem (1.26) has at least one solution $u \in W^{2,\mathcal{A}}(a, b)$. Define the operator $T : \mathcal{C}([a, b]) \rightarrow \mathcal{C}([a, b])$ given by*

$$(Tu)(t) = \int_a^b G(t, s)[f(s, \gamma(s, u(s))) - \gamma(s, u(s))] ds,$$

where $G(t, s)$ is the Green's function associated with

$$u'' - u = f(t), \quad u(a) = 0, \quad u(b) = 0.$$

We can prove that T is completely continuous and bounded (see [53,33]). Hence by Schauder Fixed Point theorem, T has a fixed point u which is a solution of (1.26) in $W^{2,\mathcal{A}}(a, b)$.

Claim 2. *Any solution u of (1.26) satisfies $\alpha \leq u \leq \beta$. Observe first that $\alpha(a) \leq u(a) \leq \beta(a)$ and $\alpha(b) \leq u(b) \leq \beta(b)$. Next, we argue as in Theorem 1.1 to obtain the result.*

Conclusion. From Claim 2, the function u , solution of (1.26), solves (1.24). □

In the definition of \mathcal{A} -Carathéodory functions, the condition $h \in \mathcal{A}$ is used to insure

$$\left\| \int_a^b G(\cdot, s)h(s) ds \right\|_\infty < +\infty \quad \text{and} \quad \int_a^b \left| \frac{\partial G}{\partial t}(\cdot, s) \right| h(s) ds \in L^1(a, b).$$

EXAMPLE 1.9. Consider the boundary value problem

$$u'' + |u|^{1/2} - \frac{1}{t} = 0, \quad u(0) = 0, \quad u(\pi) = 0.$$

It is easy to see that $\beta(t) = 0$ is an upper solution and $\alpha(t) = t \ln \frac{t}{\pi} - t$ is a lower solution. Hence we have a solution u such that for all $t \in [0, \pi]$

$$t \ln \frac{t}{\pi} - t \leq u(t) \leq 0.$$

Notice that, in this example, the function $f(t, u)$ is not L^1 -Carathéodory.

If we want more regularity, we need more restrictive conditions on f . For example, we have the following theorem.

THEOREM 1.15. *Assume that α and β are lower and upper solutions of (1.24) such that $\alpha \leq \beta$. Let E be defined from (1.2) and let $f : E \rightarrow \mathbb{R}$ satisfy a Carathéodory condition. Assume that there exists a measurable function h such that $\int_a^b (s - a)h(s) ds < \infty$ and for a.e. $t \in [a, b]$ and all $u \in \mathbb{R}$ with $(t, u) \in E$,*

$$|f(t, u)| \leq h(t).$$

Then the problem (1.24) has at least one solution $u \in W^{2,\mathcal{A}}(a, b) \cap C^1([a, b])$ such that for all $t \in [a, b]$

$$\alpha(t) \leq u(t) \leq \beta(t).$$

PROOF. Existence of a solution $u \in W^{2,\mathcal{A}}(a, b)$ follows from Theorem 1.14. Further

$$u(t) = \int_a^b G(t, s) f(s, u(s)) ds,$$

where $G(t, s)$ is the Green's function corresponding to (1.25). It is now standard to see that $u \in C^1([a, b])$. \square

1.6. Historical and bibliographical notes

The method of lower and upper solutions applied to boundary value problems is due to Scorza Dragoni in 1931. In a first paper [94], this author considers the boundary value problem

$$u'' = f(t, u, u'), \quad u(a) = A, \quad u(b) = B,$$

where f is bounded for u in bounded sets. The basic assumption is the existence of functions $\alpha, \beta \in C^2([a, b])$ such that

$$\begin{aligned}\alpha'' &= f(t, \alpha, \alpha'), & \alpha(a) &\leq A, & \alpha(b) &\leq B, \\ \beta'' &= f(t, \beta, \beta'), & \beta(a) &\geq A, & \beta(b) &\geq B.\end{aligned}$$

The same year [95], he improves his result assuming that the functions α and β satisfy differential inequalities. In these papers, the method of proof already uses an auxiliary problem, modified for $u \notin [\alpha(t), \beta(t)]$, whose solution is proved, from a maximum principle type argument, to be such that $\alpha \leq u \leq \beta$. The basic ideas are already set.

The introduction of angles in lower and upper solutions has been used by Picard [80] in 1893. This idea was rediscovered by Nagumo [74] in 1954 who worked with maximum of lower solutions. A first order condition, similar to $D_-\alpha(t_0) < D^+\alpha(t_0)$, was used by Knobloch [64] in 1963.

In 1938, Scorza Dragoni [96,97] already considers L^1 -Carathéodory functions f . Such an assumption is also made by Epheser [40] in 1955. More recently, we can quote Jackson [58], Kiguradze [62] (see also [63]), Gudkov and Lepin [46], Habets and Laloy [47], Hess [55] (see also Stampacchia [99]), Fabry and Habets [41], Adje [1], Habets and Sanchez [51], De Coster and Habets [31,32]. These papers present a variety of definitions of lower and upper solutions which are strongly related and there is no obvious reason to choose one rather than the other. Our choice, Definitions 1.1 and 1.2 (see [29,31,32]), tends to be general enough for applications and simple enough to model the geometric intuition built into the concept.

Theorems 1.1 and 1.2 are variants of the basic results of the theory. This last result can be found in [35] for the parabolic problem.

Theorem 1.3 deals with extremal solutions. Existence of extremal solutions for the Cauchy problem associated with first order ODEs were already studied by Peano [77] in 1885 and Perron [78] in 1915. Using a monotonicity assumption, Satō [89] worked in 1954 elliptic PDEs in relation with lower and upper solutions. The monotonicity assumption was deleted in 1960 for parabolic problems by Mlak [71] and in 1961 for elliptic PDEs by Akô [2]. The proof used here is inspired by the recent paper of Angel Cid [22]. For a classical proof, we refer to Akô [2] or Schmitt [92] in case of C^2 -solutions. Such proofs use maxima of lower solutions and minima of upper ones as in Theorem 1.2.

As far as the structure of the solution set is concerned, i.e., Theorem 1.4, we refer to [90] and [2].

A priori bounds on the derivative of solutions were already worked out by Bernstein [11] in 1904. Nagumo [73], in 1937, generalized these ideas introducing the so-called Nagumo condition which is both simple and very general. This is why it has been widely used since then. Basically, it is our Proposition 1.6. In 1967, Kiguradze [61] (see also Epheser [40] in 1955) observed that, for some boundary value problems, the Nagumo condition can be restricted to be one-sided conditions. Proposition 1.7 introduced such a condition. In the same paper, Kiguradze extended the Nagumo condition so as to deal with $W^{2,1}$ -solutions as we did in Propositions 1.8 and 1.9. It seems that we have to wait for Knobloch [64] in 1963 to consider the periodic problem. In 1954, Nagumo [74] pointed out that the existence of well ordered lower and upper solutions is not sufficient to ensure existence of solutions of

a Dirichlet problem. Example 1.5 presented here for the periodic problem is adapted from Habets and Pouso [50].

Theorem 1.10 extends a result of Habets and Torres [52] avoiding the assumption $\alpha, \beta \in W^{1,\infty}(a, b)$. Theorem 1.11 is due to Mawhin [70] and Theorem 1.12 is the counterpart for the periodic problem of a result of De Coster [28].

Rosenblatt [88] already noticed in 1933 that Dirichlet problems can be studied for more singular nonlinearities than L^p -Carathéodory functions. In 1953, Prodi [86] used lower and upper solutions for such singular problems. Theorems 1.14 and 1.15 follow Habets and Zanolin [53] and [54], where the Dirichlet boundary value problem is investigated with another definition of lower and upper solutions.

2. Relation with degree theory

2.1. The periodic problem

In order to use degree theory, we need to reinforce the notion of lower and upper solution.

DEFINITIONS 2.1. A lower solution α of

$$u'' = f(t, u, u'), \quad u(a) = u(b), \quad u'(a) = u'(b), \tag{2.1}$$

is said to be a *strict lower solution* if every solution u of (2.1) with $u \geq \alpha$ is such that $u(t) > \alpha(t)$ on $[a, b]$.

Similarly, an upper solution β of (2.1) is said to be a *strict upper solution* if every solution u of (2.1) with $u \leq \beta$ is such that $u(t) < \beta(t)$ on $[a, b]$.

The classical way to obtain lower and upper solutions in the case of a continuous function f is described in the following propositions.

PROPOSITION 2.1. Let $f : [a, b] \times \mathbb{R}^2 \rightarrow \mathbb{R}$ be continuous and $\alpha \in C^2([a, b])$ be such that

- (a) for all $t \in [a, b]$, $\alpha''(t) > f(t, \alpha(t), \alpha'(t))$;
- (b) $\alpha(a) = \alpha(b)$, $\alpha'(a) \geq \alpha'(b)$.

Then α is a strict lower solution of (2.1).

PROOF. Let u be a solution of (2.1) such that $u \geq \alpha$ and assume, by contradiction, that

$$\min_t (u(t) - \alpha(t)) = u(t_0) - \alpha(t_0) = 0.$$

We have $u'(t_0) - \alpha'(t_0) = 0$; in case $t_0 = a$ or b , this follows from assumption (b). Hence, we obtain the contradiction

$$0 \leq u''(t_0) - \alpha''(t_0) = f(t_0, \alpha(t_0), \alpha'(t_0)) - \alpha''(t_0) < 0.$$

□

Using the same argument we obtain the corresponding result for upper solutions.

PROPOSITION 2.2. Let $f : [a, b] \times \mathbb{R}^2 \rightarrow \mathbb{R}$ be continuous and $\beta \in \mathcal{C}^2([a, b])$ be such that

- (a) for all $t \in [a, b]$, $\beta''(t) < f(t, \beta(t), \beta'(t))$;
- (b) $\beta(a) = \beta(b)$, $\beta'(a) \leq \beta'(b)$.

Then β is a strict upper solution of (2.1).

If f is not continuous but L^1 -Carathéodory, these last results do not hold anymore. Even the stronger condition

$$\text{for a.e. } t \in [a, b], \quad \alpha''(t) \geq f(t, \alpha(t), \alpha'(t)) + 1$$

does not prevent solutions u of (2.1) to be tangent to the curve $u = \alpha(t)$ from above. This is, for example, the case for the bounded function

$$f(t, u) := \begin{cases} -1, & u \leq -1, \\ -\frac{u^2 + \sin t}{1 + \sin t}, & -1 < u \leq \sin t, \\ -\sin t, & \sin t < u, \end{cases}$$

if we consider $\alpha(t) \equiv -1$, $u(t) \equiv \sin t$, $a = 0$ and $b = 2\pi$. This remark motivates the following proposition.

PROPOSITION 2.3. Let $f : [a, b] \times \mathbb{R}^2 \rightarrow \mathbb{R}$ be an L^1 -Carathéodory function. Let $\alpha \in \mathcal{C}([a, b])$ be such that $\alpha(a) = \alpha(b)$ and consider its periodic extension on \mathbb{R} . Assume that α is not a solution of (2.1) and for any $t_0 \in \mathbb{R}$, either

- (a) $D_- \alpha(t_0) < D^+ \alpha(t_0)$ or
- (b) there exist an open interval I_0 and an $\epsilon_0 > 0$ such that $t_0 \in I_0$, $\alpha \in W^{2,1}(I_0)$ and for a.e. $t \in I_0$, all $u \in [\alpha(t), \alpha(t) + \epsilon_0]$ and all $v \in [\alpha'(t) - \epsilon_0, \alpha'(t) + \epsilon_0]$,

$$\alpha''(t) \geq f(t, u, v).$$

Then α is a strict lower solution of (2.1).

PROOF. The function α is a lower solution since clearly it satisfies Definition 1.2. Let u be a solution of (2.1) such that $u \geq \alpha$. As α is not a solution, there exists t^* such that $u(t^*) > \alpha(t^*)$. Extend u and α by periodicity and assume, by contradiction, that

$$t_0 = \inf\{t > t^* \mid u(t) = \alpha(t)\}$$

exists. As $\alpha - u$ is maximum at t_0 , we have $D_- \alpha(t_0) - u'(t_0) \geq D^+ \alpha(t_0) - u'(t_0)$. Hence, assumption (b) applies. This implies that $\alpha'(t_0) - u'(t_0) = 0$ and there exist I_0 and $\epsilon_0 > 0$ according to (b). It follows we can choose $t_1 \in I_0$ with $t_1 < t_0$ such that $\alpha'(t_1) - u'(t_1) > 0$ and for every $t \in]t_1, t_0[$

$$u(t) \leq \alpha(t) + \epsilon_0, \quad |\alpha'(t) - u'(t)| < \epsilon_0.$$

Hence, for almost every $t \in]t_1, t_0[$, we can write

$$\alpha''(t) \geq f(t, u(t), u'(t)),$$

which leads to the contradiction

$$0 > (\alpha' - u')(t_0) - (\alpha' - u')(t_1) = \int_{t_1}^{t_0} [\alpha''(t) - f(t, u(t), u'(t))] dt \geq 0.$$

□

In the same way we can prove the following result on strict upper solutions.

PROPOSITION 2.4. *Let $f : [a, b] \times \mathbb{R}^2 \rightarrow \mathbb{R}$ be an L^1 -Carathéodory function. Let $\beta \in \mathcal{C}([a, b])$ be such that $\beta(a) = \beta(b)$ and consider its periodic extension on \mathbb{R} . Assume that β is not a solution of (2.1) and for any $t_0 \in \mathbb{R}$, either*

- (a) $D^- \beta(t_0) > D_+ \beta(t_0)$ or
- (b) *there exist an open interval I_0 and an $\epsilon_0 > 0$ such that $t_0 \in I_0$, $\beta \in W^{2,1}(I_0)$ and for a.e. $t \in I_0$, all $u \in [\beta(t) - \epsilon_0, \beta(t)]$ and all $v \in [\beta'(t) - \epsilon_0, \beta'(t) + \epsilon_0]$,*

$$\beta''(t) \leq f(t, u, v).$$

Then β is a strict upper solution of (2.1).

REMARK. Notice that Propositions 2.3 and 2.4 apply with nonstrict inequalities $\alpha''(t) \geq f(t, \alpha(t), \alpha'(t))$ and $\beta''(t) \leq f(t, \beta(t), \beta'(t))$. Hence, even if f is continuous, these propositions generalize Propositions 2.1 and 2.2.

The relation between degree theory and lower and upper solutions is described in the following result which completes Theorem 1.12.

THEOREM 2.5. *Let α and $\beta \in \mathcal{C}([a, b])$ be strict lower and upper solutions of (2.1) such that $\alpha \leq \beta$. Define $A \subset [a, b]$ (respectively $B \subset [a, b]$) to be the set of points where α (respectively β) is differentiable. Let $p, q \in [1, \infty]$ with $\frac{1}{p} + \frac{1}{q} = 1$, $\psi \in L^p(a, b)$ and $\varphi \in \mathcal{C}(\mathbb{R}^+, \mathbb{R}_0^+)$ be such that (1.15) holds (with $\bar{\varphi} = \varphi$). Let E be defined from (1.19) and suppose $f : E \rightarrow \mathbb{R}$ is an L^p -Carathéodory function that satisfies the one-sided Nagumo condition (1.17) (with $\bar{\varphi} = \varphi$ and $\bar{\psi} = \psi$). Assume there exists $N \in L^1(a, b)$, $N > 0$, such that for a.e. $t \in A$ (respectively for a.e. $t \in B$) (1.21) is satisfied. Then*

$$\deg(I - T, \Omega) = 1, \tag{2.2}$$

where $T : \mathcal{C}^1([a, b]) \rightarrow \mathcal{C}^1([a, b])$ is defined by

$$(Tu)(t) := \int_a^b G(t, s) [f(s, u(s), u'(s)) - u(s)] ds, \tag{2.3}$$

$G(t, s)$ is the Green's function corresponding to (1.5) and Ω is given by

$$\Omega = \{u \in C^1([a, b]) \mid \forall t \in [a, b], \alpha(t) < u(t) < \beta(t), |u'(t)| < R\}, \quad (2.4)$$

with $R > 0$ large enough. In particular, the problem (2.1) has at least one solution $u \in W^{2,p}(a, b)$ such that for all $t \in [a, b]$

$$\alpha(t) < u(t) < \beta(t).$$

PROOF. Define $R > 0$ as in the proof of Theorem 1.12 and consider the modified problem (1.22). This problem is equivalent to the fixed point problem

$$u = \bar{T}u,$$

where $\bar{T}: C^1([a, b]) \rightarrow C^1([a, b])$ is defined by

$$(\bar{T}u)(t) = \int_a^b G(t, s) [\bar{f}(s, \gamma(s, u(s)), u'(s)) - \omega(s, u(s))] ds.$$

Observe that \bar{T} is completely continuous. Further there exists \bar{R} large enough so that $\Omega \subset B(0, \bar{R})$ and $\bar{T}(C^1([a, b])) \subset B(0, \bar{R})$. Hence we have, by the properties of the degree,

$$\deg(I - \bar{T}, B(0, \bar{R})) = 1.$$

We know that every fixed point of \bar{T} is a solution of (1.22). Arguing as in the proof of Theorem 1.12, we see that $\alpha \leq u \leq \beta$ and $\|u'\|_\infty < R$. As α and β are strict, $\alpha < u < \beta$. Hence, every fixed point of \bar{T} is in Ω and by the excision property we obtain

$$\deg(I - T, \Omega) = \deg(I - \bar{T}, \Omega) = \deg(I - \bar{T}, B(0, \bar{R})) = 1.$$

Existence of a solution u such that for all $t \in [a, b]$,

$$\alpha(t) < u(t) < \beta(t)$$

follows now from the properties of the degree. □

In case we consider a derivative independent problem

$$u'' = f(t, u), \quad u(a) = u(b), \quad u'(a) = u'(b), \quad (2.5)$$

we can simplify this theorem defining T on $C([a, b])$ rather than on $C^1([a, b])$.

THEOREM 2.6. *Let α and $\beta \in C([a, b])$ be strict lower and upper solutions of (2.5) such that $\alpha \leq \beta$. Let E be defined from (1.2) and suppose $f: E \rightarrow \mathbb{R}$ is an L^1 -Carathéodory function. Then*

$$\deg(I - T, \Omega) = 1,$$

where $T : \mathcal{C}([a, b]) \rightarrow \mathcal{C}([a, b])$ is defined by

$$(Tu)(t) := \int_a^b G(t, s)[f(s, u(s)) - u(s)] ds,$$

$G(t, s)$ is the Green's function corresponding to (1.5) and Ω is given by

$$\Omega = \{u \in \mathcal{C}([a, b]) \mid \forall t \in [a, b], \alpha(t) < u(t) < \beta(t)\}.$$

In particular, the problem (2.5) has at least one solution $u \in W^{2,1}(a, b)$ such that for all $t \in [a, b]$

$$\alpha(t) < u(t) < \beta(t).$$

The proof of this theorem repeats the argument used in the proof of Theorem 2.5.

These theorems can be used to obtain multiplicity results. We present here such a theorem where, for simplicity, we assume the nonlinearity not to depend on the derivative. Such a restriction is by no means essential.

THEOREM 2.7 (The Three Solutions theorem). *Let α_1, β_1 and $\alpha_2, \beta_2 \in \mathcal{C}([a, b])$ be two pairs of lower and upper solutions of (2.5) such that for all $t \in [a, b]$,*

$$\alpha_1(t) \leq \beta_1(t), \quad \alpha_2(t) \leq \beta_2(t), \quad \alpha_1(t) \leq \beta_2(t)$$

and for some $t_0 \in [a, b]$,

$$\alpha_2(t_0) > \beta_1(t_0).$$

Assume further β_1 and α_2 are strict upper and lower solutions. Let E be defined from (1.2) (with $\alpha = \min\{\alpha_1, \alpha_2\}$ and $\beta = \max\{\beta_1, \beta_2\}$) and suppose $f : E \rightarrow \mathbb{R}$ is an L^1 -Carathéodory function. Then, the problem (2.5) has at least three solutions $u_1, u_2, u_3 \in W^{2,1}(a, b)$ such that for all $t \in [a, b]$,

$$\alpha_1(t) \leq u_1(t) < \beta_1(t), \quad \alpha_2(t) < u_2(t) \leq \beta_2(t), \quad u_1(t) \leq u_3(t) \leq u_2(t)$$

and for some $t_1, t_2 \in [a, b]$,

$$u_3(t_1) > \beta_1(t_1), \quad u_3(t_2) < \alpha_2(t_2).$$

PROOF. Consider the modified problem

$$u'' - u = f(t, \gamma(t, u)) - \gamma(t, u), \quad u(a) = u(b), \quad u'(a) = u'(b), \tag{2.6}$$

where $\gamma(t, u) = \max\{\min\{\beta_2(t), u\}, \alpha_1(t)\}$. Let us choose k so that $\beta_1 \leq \beta_2 + k$ and $\alpha_1 - k \leq \alpha_2$, and define $T : \mathcal{C}([a, b]) \rightarrow \mathcal{C}([a, b])$ by

$$(Tu)(t) = \int_a^b G(t, s)[f(s, \gamma(s, u(s))) - \gamma(s, u(s))] ds,$$

where $G(t, s)$ is the Green's function corresponding to (1.5).

Step 1. Computation of $d(I - T, \Omega_{1,1})$, where

$$\Omega_{1,1} = \{u \in C([a, b]) \mid \forall t \in [a, b], \alpha_1(t) - k < u(t) < \beta_1(t)\}.$$

Define the alternative modified problem

$$u'' - u = \bar{f}(t, u) - \bar{\gamma}(t, u), \quad u(a) = u(b), \quad u'(a) = u'(b),$$

where $\bar{\gamma}(t, u) = \max\{\min\{\beta_1(t), \beta_2(t), u\}, \alpha_1(t)\}$ and

$$\bar{f}(t, u) = \begin{cases} f(t, \alpha_1(t)), & \text{if } u \leq \alpha_1(t), \\ f(t, u), & \text{if } \alpha_1(t) < u < \min\{\beta_1(t), \beta_2(t)\}, \\ \max_{i=1,2}\{f(t, \min\{\beta_i(t), u\})\}, & \text{if } \min\{\beta_1(t), \beta_2(t)\} \leq u. \end{cases}$$

Define next $\bar{T}: C([a, b]) \rightarrow C([a, b])$ by

$$(\bar{T}u)(t) = \int_a^b G(t, s)[f(s, \bar{\gamma}(s, u(s))) - \bar{\gamma}(s, u(s))] ds.$$

For any $\lambda \in [0, 1]$, we consider then the homotopy $\mathcal{T}_\lambda = \lambda\bar{T} + (1 - \lambda)T$.

Claim 1. If $\lambda \in [0, 1]$ and u is a fixed point of \mathcal{T}_λ , we have $u \geq \alpha_1$. This follows from the usual maximum principle argument as in Claim 2 of the proof of Theorem 1.1.

Claim 2. If $\lambda \in [0, 1]$ and u is a fixed point of \mathcal{T}_λ , we have $u \leq \beta_2$. Notice that u solves

$$u'' - u = \lambda[\bar{f}(t, u) - \bar{\gamma}(t, u)] + (1 - \lambda)[f(t, \gamma(t, u)) - \gamma(t, u)], \\ u(a) = u(b), \quad u'(a) = u'(b).$$

Assume now that for some $t_0 \in [a, b]$, $u(t_0) - \beta_2(t_0) > 0$. Hence for t near enough t_0 , we can write

$$u''(t) - u(t) \geq f(t, \beta_2(t)) - \beta_2(t) \geq \beta_2''(t) - \beta_2(t),$$

i.e.,

$$u''(t) - \beta_2''(t) \geq u(t) - \beta_2(t) > 0,$$

which contradicts the fact that t_0 maximizes $u - \beta_2$.

Claim 3. If $\lambda \in [0, 1]$ and $u \in \bar{\Omega}_{1,1}$ is a fixed point of \mathcal{T}_λ , we have $u < \beta_1$. Assume there exists $t_0 \in [a, b]$ such that $u(t_0) = \beta_1(t_0)$. We deduce from Claims 1 and 2 that $\alpha_1(t) \leq u(t) \leq \beta_2(t)$ for all $t \in [a, b]$ so that u solves (2.5). As further β_1 is a strict upper solution, the claim follows.

Claim 4. $\deg(I - T, \Omega_{1,1}) = 1$. Observe that \bar{T} is completely continuous. Further there exists R large enough so that $\Omega_{1,1} \subset B(0, R)$ and $\bar{T}(C^1([a, b])) \subset B(0, R)$. On the other

hand, we know from the usual maximum principle argument (see the proof of Theorem 1.2) that fixed points u of \bar{T} are such that $\alpha_1 \leq u \leq \min\{\beta_1(t), \beta_2(t)\}$. Hence we deduce from Claim 3 that $u < \beta_1$. Now we can deduce from the properties of the degree,

$$\deg(I - \bar{T}, \Omega_{1,1}) = \deg(I - \bar{T}, B(0, R)) = 1$$

and using the above claims

$$\deg(I - T, \Omega_{1,1}) = \deg(I - T_\lambda, \Omega_{1,1}) = \deg(I - \bar{T}, \Omega_{1,1}) = 1.$$

Step 2. $\deg(I - T, \Omega_{2,2}) = 1$, where

$$\Omega_{2,2} = \{u \in C([a, b]) \mid \forall t \in [a, b], \alpha_2(t) < u(t) < \beta_2(t) + k\}.$$

The proof of this result parallels the proof of Step 1.

Step 3. There exist three solutions \bar{u}_i ($i = 1, 2, 3$) of (2.6) such that

$$\alpha_1 - k < \bar{u}_1 < \beta_1, \quad \alpha_2 < \bar{u}_2 < \beta_2 + k, \quad \alpha_1 - k < \bar{u}_3 < \beta_2 + k$$

and there exist $t_1, t_2 \in [a, b]$ with

$$\bar{u}_3(t_1) > \beta_1(t_1), \quad \bar{u}_3(t_2) < \alpha_2(t_2).$$

The two first solutions are obtained from the fact that

$$\deg(I - T, \Omega_{1,1}) = 1 \quad \text{and} \quad \deg(I - T, \Omega_{2,2}) = 1.$$

Define

$$\Omega_{1,2} = \{u \in C([a, b]) \mid \forall t \in [a, b], \alpha_1(t) - k < u(t) < \beta_2(t) + k\}.$$

We have

$$\begin{aligned} 1 &= \deg(I - T, \Omega_{1,2}) \\ &= \deg(I - T, \Omega_{1,1}) + \deg(I - T, \Omega_{2,2}) + \deg(I - T, \Omega_{1,2} \setminus (\bar{\Omega}_{1,1} \cup \bar{\Omega}_{2,2})) \end{aligned}$$

which implies

$$\deg(I - T, \Omega_{1,2} \setminus (\bar{\Omega}_{1,1} \cup \bar{\Omega}_{2,2})) = -1$$

and the existence of $\bar{u}_3 \in \Omega_{1,2} \setminus (\bar{\Omega}_{1,1} \cup \bar{\Omega}_{2,2})$ follows.

Step 4. There exist solutions u_i ($i = 1, 2, 3$), of (2.5) such that

$$\alpha_1 \leq u_1 < \beta_1, \quad \alpha_2 < u_2 \leq \beta_2, \quad u_1 \leq u_3 \leq u_2$$

and there exist $t_1, t_2 \in [a, b]$, with

$$u_3(t_1) > \beta_1(t_1), \quad u_3(t_2) < \alpha_2(t_2).$$

We know that solutions u of (2.6) are such that

$$\alpha_1 \leq u \leq \beta_2,$$

i.e., they are solutions of (2.5). Next, from Theorem 1.3, we know there exist extremal solutions u_{\min} and u_{\max} of (2.5) in $[\alpha_1, \beta_2]$. The claim follows then with $u_1 = u_{\min}$, $u_2 = u_{\max}$ and $u_3 = \bar{u}_3$. \square

Observe that in this theorem $u_1 \leq \min\{\beta_1, \beta_2\}$ and $u_2 \geq \max\{\alpha_1, \alpha_2\}$.

EXAMPLE 2.1. Consider the problem

$$u'' + \sin u = h(t), \quad u(0) = u(2\pi), \quad u'(0) = u'(2\pi). \tag{2.7}$$

Let $h \in C([0, 2\pi])$ and write $\bar{h} = \frac{1}{2\pi} \int_0^{2\pi} h(s) ds$ and $\tilde{h} = h - \bar{h}$. Assume $\|\tilde{h}\|_{L^1} \leq 3$ and $|\bar{h}| < \cos(\frac{\pi}{6} \|\tilde{h}\|_{L^1})$. Let w be the solution of

$$w'' = \tilde{h}(t), \quad w(0) = w(2\pi), \quad w'(0) = w'(2\pi), \quad \int_0^{2\pi} w(s) ds = 0,$$

and

$$\alpha_1 = -\frac{3\pi}{2} + w, \quad \beta_1 = -\frac{\pi}{2} + w, \quad \alpha_2 = \frac{\pi}{2} + w, \quad \beta_2 = \frac{3\pi}{2} + w.$$

Using Theorem 2.7 and the estimate $\|w\|_\infty \leq \frac{\pi}{6} \|\tilde{h}\|_{L^1}$ (see [44] or [33]) we find three solutions of (2.7)

$$u_1 \in]\alpha_1, \beta_1[, \quad u_2 \in]\alpha_2, \beta_2[\quad \text{and} \quad u_3 \in]\alpha_1, \beta_2[,$$

with $u_3(t_1) \geq \beta_1(t_1)$ and $u_3(t_2) \leq \alpha_2(t_2)$ for some t_1 and $t_2 \in [0, 2\pi]$. Notice then that u_1 might be $u_2 - 2\pi$ but $u_3 \neq u_1 \pmod{2\pi}$. Hence, this problem has at least two geometrically different solutions.

2.2. The Dirichlet problem

In this section, we consider the Dirichlet problem

$$u'' = f(t, u), \quad u(a) = 0, \quad u(b) = 0, \tag{2.8}$$

where f is an L^p -Carathéodory function. To focus on the main ideas and avoid technical difficulties we restrict our analysis to derivative independent nonlinearities. Problem (2.8) is equivalent to the fixed point problem

$$u(t) = (Tu)(t) := \int_a^b G(t, s) f(s, u(s)) ds, \tag{2.9}$$

where $G(t, s)$ is the Green's function corresponding to (1.25).

In this section, we consider the degree of $I - T$ for an open set Ω of functions u that lie between the lower and upper solutions α and β . If we allow α and β to satisfy the boundary conditions, the set

$$\Omega = \{u \in C_0([a, b]) \mid \forall t \in]a, b[, \alpha(t) < u(t) < \beta(t)\},$$

might not be open in $C_0([a, b])$. A way out is to impose some additional conditions on the functions u at these boundary points. To this end, for $u, v \in C([a, b])$, we write $u \succ v$ or $v \prec u$ if there exists $\epsilon > 0$ such that for any $t \in [a, b]$

$$u(t) - v(t) \geq \epsilon e(t),$$

where $e(t) := \sin(\pi \frac{t-a}{b-a})$. We can then work with the space $C_0^1([a, b])$ and use the set

$$\Omega = \{u \in C_0^1([a, b]) \mid \alpha \prec u \prec \beta\}. \tag{2.10}$$

This set is open in $C_0^1([a, b])$.

A possible alternative used by Amann (see [6]) is to work with the space

$$C_e = \{u \in C([a, b]) \mid \exists \lambda > 0, \forall t \in [a, b], |u(t)| \leq \lambda e(t)\}.$$

In our case, this approach does not seem to be simpler and as the solutions are anyhow in $C_0^1([a, b])$, we choose to work in the more usual space $C_0^1([a, b])$.

DEFINITIONS 2.2. A lower solution α of (2.8) is said to be a *strict lower solution* if every solution u of (2.8) with $\alpha \leq u$ is such that $\alpha \prec u$.

An upper solution β of (2.8) is said to be a *strict upper solution* if every solution u of (2.8) with $u \leq \beta$ is such that $u \prec \beta$.

A first result concerns lower and upper solutions which are C^2 .

PROPOSITION 2.8. Let $f : [a, b] \times \mathbb{R} \rightarrow \mathbb{R}$ be continuous and $\alpha \in C([a, b]) \cap C^2(]a, b[)$ be such that

- (a) for all $t \in]a, b[, \alpha''(t) > f(t, \alpha(t))$;
- (b) for $t_0 \in \{a, b\}$, either $\alpha(t_0) < 0$
or $\alpha(t_0) = 0, \alpha \in C^2(]a, b[\cup \{t_0\})$ and $\alpha''(t_0) > f(t_0, \alpha(t_0))$.

Then α is a strict lower solution of (2.8).

PROOF. From the assumptions, α is a lower solution of (2.8). Let then u be a solution of (2.8) such that $\alpha \leq u$ and assume, by contradiction, that for any $n \in \mathbb{N}_0$, there exists $t_n \in]a, b[$ such that

$$u(t_n) - \alpha(t_n) < \frac{1}{n} \sin\left(\pi \frac{t_n - a}{b - a}\right). \tag{2.11}$$

It follows there exists a subsequence of $(t_n)_n$ that converges to a point t_0 such that $u(t_0) = \alpha(t_0)$. If $t_0 \in]a, b[$, we have $u'(t_0) = \alpha'(t_0)$. On the other hand, if $t_0 = a$, we know that $\alpha \in C^2([a, b])$ and we deduce from (2.11) that

$$\frac{u(t_n) - u(a)}{t_n - a} \leq \frac{\alpha(t_n) + \frac{1}{n} \sin\left(\pi \frac{t_n - a}{b - a}\right) - \alpha(a)}{t_n - a}.$$

This implies $u'(a) \leq \alpha'(a)$. As further $u - \alpha$ is minimum at $t = a$, we also have $u'(a) \geq \alpha'(a)$. Hence, $u'(a) = \alpha'(a)$. A similar reasoning applies if $t_0 = b$ so that in all cases $u'(t_0) - \alpha'(t_0) = 0$. Finally, we obtain the contradiction $0 \leq u''(t_0) - \alpha''(t_0) = f(t_0, \alpha(t_0)) - \alpha''(t_0) < 0$. \square

In a similar way, we can write

PROPOSITION 2.9. Let $f : [a, b] \times \mathbb{R} \rightarrow \mathbb{R}$ be continuous and $\beta \in C([a, b]) \cap C^2(]a, b[)$ be such that

- (a) for all $t \in]a, b[$, $\beta''(t) < f(t, \beta(t))$;
- (b) for $t_0 \in \{a, b\}$, either $\beta(t_0) > 0$
or $\beta(t_0) = 0$, $\beta \in C^2(]a, b[\cup \{t_0\})$ and $\beta''(t_0) < f(t_0, \beta(t_0))$.

Then β is a strict upper solution of (2.8).

Notice that an upper solution β such that

$$\beta''(t) < f(t, \beta(t)) \quad \text{on }]a, b[, \quad \beta(a) \geq 0, \quad \beta(b) \geq 0$$

is not necessarily strict. Consider for example the problem (2.8) defined on $[a, b] = [0, 2\pi]$ with

$$f(t, u) = \begin{cases} 0, & \text{if } u \leq 0, \\ 7u/t^2, & \text{if } 0 < u \leq t^3, \\ 7t, & \text{if } u > t^3. \end{cases}$$

The function $u(t) = 0$ is a solution and $\beta(t) = t^3$ is an upper solution that satisfies $\beta''(t) < f(t, \beta(t))$ on $]0, 2\pi]$, $\beta(0) = u(0)$ and $\beta'(0) = u'(0)$.

In the Carathéodory case, we can use the following propositions.

PROPOSITION 2.10. Let $f : [a, b] \times \mathbb{R} \rightarrow \mathbb{R}$ be an L^1 -Carathéodory function. Assume that $\alpha \in C([a, b])$ is not a solution of (2.8) and that

- (a) for any $t_0 \in]a, b[$, either $D_-\alpha(t_0) < D^+\alpha(t_0)$
 or there exist an open interval $I_0 \subset [a, b]$ and $\epsilon_0 > 0$ such that $t_0 \in I_0$, $\alpha \in W^{2,1}(I_0)$
 and for a.e. $t \in I_0$ and all $u \in [\alpha(t), \alpha(t) + \epsilon_0 \sin(\pi \frac{t-a}{b-a})]$,

$$\alpha''(t) \geq f(t, u);$$

- (b) either $\alpha(a) < 0$
 or $\alpha(a) = 0$ and there exists $\epsilon_0 > 0$ such that $\alpha \in W^{2,1}(a, a + \epsilon_0)$ and for a.e.
 $t \in [a, a + \epsilon_0]$ and all $u \in [\alpha(t), \alpha(t) + \epsilon_0 \sin(\pi \frac{t-a}{b-a})]$,

$$\alpha''(t) \geq f(t, u);$$

- (c) either $\alpha(b) < 0$
 or $\alpha(b) = 0$ and there exists $\epsilon_0 > 0$ such that $\alpha \in W^{2,1}(b - \epsilon_0, b)$ and for a.e. $t \in$
 $[b - \epsilon_0, b]$ and all $u \in [\alpha(t), \alpha(t) + \epsilon_0 \sin(\pi \frac{t-a}{b-a})]$,

$$\alpha''(t) \geq f(t, u).$$

Then α is a strict lower solution of (2.8).

PROOF. Notice first that α satisfies Definition 1.3 and therefore is a lower solution.

Let u be a solution of (2.8) such that $u \geq \alpha$. Arguing by contradiction as in Proposition 2.8 there exists a sequence $(t_n)_n$ that satisfies (2.11) and converges to a point t_0 such that $u(t_0) = \alpha(t_0)$ and $u'(t_0) = \alpha'(t_0)$.

As α is not a solution, we can find t^* such that $u(t^*) > \alpha(t^*)$. Assume $t_0 < t^*$ and define $t_1 = \max\{t < t^* \mid u(t) = \alpha(t)\}$. Notice then that $u(t_1) = \alpha(t_1)$ and $u'(t_1) = \alpha'(t_1)$ and fix $\epsilon_0 > 0$ according to the assumptions. Next, for $t \geq t_1$ near enough t_1

$$u(t) \in \left[\alpha(t), \alpha(t) + \epsilon_0 \sin\left(\pi \frac{t-a}{b-a}\right) \right]$$

and we compute

$$u'(t) - \alpha'(t) = \int_{t_1}^t [f(s, u(s)) - \alpha''(s)] ds \leq 0,$$

which contradicts the definition of t_1 . A similar argument holds if $t_0 > t^*$. □

Strict upper solutions can be obtained from a similar proposition.

PROPOSITION 2.11. Let $f : [a, b] \times \mathbb{R} \rightarrow \mathbb{R}$ be an L^1 -Carathéodory function. Assume that $\beta \in C([a, b])$ is not a solution of (2.8) and that

- (a) for any $t_0 \in]a, b[$, either $D^- \beta(t_0) > D_+ \beta(t_0)$
 or there exist an open interval $I_0 \subset]a, b[$ and $\epsilon_0 > 0$ such that $t_0 \in I_0$, $\beta \in W^{2,1}(I_0)$
 and for a.e. $t \in I_0$ and all $u \in [\beta(t) - \epsilon_0 \sin(\pi \frac{t-a}{b-a}), \beta(t)]$,

$$\beta''(t) \leq f(t, u);$$

- (b) either $\beta(a) > 0$
 or $\beta(a) = 0$ and there exists $\epsilon_0 > 0$ such that $\beta \in W^{2,1}(a, a + \epsilon_0)$ and for a.e.
 $t \in [a, a + \epsilon_0]$ and all $u \in [\beta(t) - \epsilon_0 \sin(\pi \frac{t-a}{b-a}), \beta(t)]$,

$$\beta''(t) \leq f(t, u);$$

- (c) either $\beta(b) > 0$
 or $\beta(b) = 0$ and there exists $\epsilon_0 > 0$ such that $\beta \in W^{2,1}(b - \epsilon_0, b)$ and for a.e.
 $t \in [b - \epsilon_0, b]$ and all $u \in [\beta(t) - \epsilon_0 \sin(\pi \frac{t-a}{b-a}), \beta(t)]$,

$$\beta''(t) \leq f(t, u).$$

Then β is a strict upper solution of (2.8).

We can study cases where f satisfies a one-sided Lipschitz condition in u .

PROPOSITION 2.12. Let $f : [a, b] \times \mathbb{R} \rightarrow \mathbb{R}$ be an L^1 -Carathéodory function such that,
 for some $k \in L^1(a, b; \mathbb{R}^+)$, for a.e. $t \in [a, b]$, all $u_1, u_2 \in \mathbb{R}$,

$$u_1 \leq u_2 \Rightarrow f(t, u_2) - f(t, u_1) \leq k(t)(u_2 - u_1);$$

Let α (respectively β) be a lower (respectively upper) solution of (2.8) which is not a
 solution and assume

- (a) either $\alpha(a) < 0$ (respectively $\beta(a) > 0$)
 or $\alpha(a) = 0$ (respectively $\beta(a) = 0$) and there exists an interval $I_0 = [a, c[\subset [a, b]$
 such that $\alpha \in W^{2,1}(I_0)$ (respectively $\beta \in W^{2,1}(I_0)$) and, for a.e. $t \in I_0$,

$$\alpha''(t) \geq f(t, \alpha(t)) \quad (\text{respectively } \beta''(t) \leq f(t, \beta(t)));$$

- (b) either $\alpha(b) < 0$ (respectively $\beta(b) > 0$)
 or $\alpha(b) = 0$ (respectively $\beta(b) = 0$) and there exists an interval $I_0 =]c, b] \subset [a, b]$
 such that $\alpha \in W^{2,1}(I_0)$ (respectively $\beta \in W^{2,1}(I_0)$) and, for a.e. $t \in I_0$,

$$\alpha''(t) \geq f(t, \alpha(t)) \quad (\text{respectively } \beta''(t) \leq f(t, \beta(t))).$$

Then α (respectively β) is a strict lower solution (respectively a strict upper solution)
 of (2.8).

PROOF. We prove the proposition for a lower solution α .

Let u be a solution of (2.8) such that $u \geq \alpha$ and assume by contradiction, as in Proposition 2.8, that for all $n \in \mathbb{N}_0$ there exists $t_n \in [a, b]$ such that (2.11) holds and that the sequence $(t_n)_n$ converges to some $t^* \in [a, b]$ which satisfies $u(t^*) = \alpha(t^*)$ and $u'(t^*) = \alpha'(t^*)$. Define $t_0 = \min\{t \in [a, b] \mid u(t) = \alpha(t) \text{ and } u'(t) = \alpha'(t)\}$. If $t_0 \neq a$, we can find an interval I_0 such that for a.e. $t \in I_0$

$$\alpha''(t) \geq f(t, \alpha(t))$$

and $t_1 \in I_0$ with $t_1 < t_0$. Notice that $u(t_1) > \alpha(t_1)$. On $[t_1, t_0[$ the function $w = u - \alpha$ verifies

$$\begin{aligned} -w'' + k(t)w &\geq -f(t, u(t)) + f(t, \alpha(t)) + k(t)(u(t) - \alpha(t)) \geq 0, \\ w(t_1) &> 0, \quad w(t_0) = 0, \quad w'(t_0) = 0. \end{aligned}$$

Define then v to be the solution of

$$v'' = k(t)v, \quad v(t_1) = 0, \quad v'(t_1) = 1.$$

As v is positive on $]t_1, t_0[$, we have the contradiction

$$0 < w(t_1) = (w'(t)v(t) - w(t)v'(t))\Big|_{t_1}^{t_0} = \int_{t_1}^{t_0} (w''(s) - k(s)w(s))v(s) \, ds \leq 0.$$

If $t_0 = a$ we define t^0 to be the maximum of the points $t \in [a, b]$ such that for all $s \in [a, t]$, $u(s) = \alpha(s)$ and $u'(s) = \alpha'(s)$. As α is not a solution, $t^0 < b$ and a similar argument applies to the right of t^0 . □

As in the periodic case, we associate with lower and upper solutions some sets Ω which are such that if T is defined from (2.9), the degree of $I - T$ on such a set is 1.

THEOREM 2.13. *Let α and $\beta \in \mathcal{C}([a, b])$ be strict lower and upper solutions of the problem (2.8) such that $\alpha < \beta$. Define E from (1.2) and assume $f : E \rightarrow \mathbb{R}$ is an L^1 -Carathéodory function. Then, for $R > 0$ large enough,*

$$\text{deg}(I - T, \Omega) = 1,$$

where $\Omega = \{u \in \mathcal{C}_0^1([a, b]) \mid \alpha < u < \beta, \|u\|_{\mathcal{C}^1} < R\}$ and $T : \mathcal{C}_0^1([a, b]) \rightarrow \mathcal{C}_0^1([a, b])$ is defined by (2.9). In particular, the problem (2.8) has at least one solution $u \in W^{2,1}(a, b)$ such that

$$\alpha < u < \beta.$$

PROOF. We consider the modified problem

$$u'' = f(t, \gamma(t, u)), \quad u(a) = 0, \quad u(b) = 0, \tag{2.12}$$

with $\gamma(t, u)$ defined from (1.4). This problem is equivalent to the fixed point problem

$$u = \bar{T}u,$$

where $\bar{T} : \mathcal{C}_0^1([a, b]) \rightarrow \mathcal{C}_0^1([a, b])$ is defined by

$$(\bar{T}u)(t) := \int_a^b G(t, s) f(s, \gamma(s, u(s))) \, ds$$

and $G(t, s)$ is the Green's function corresponding to (1.25). Notice that \bar{T} is completely continuous and for R large enough, $\bar{T}(\mathcal{C}_0^1([a, b])) \subset B(0, R)$. Hence by the properties of the degree

$$\deg(I - \bar{T}, B(0, R)) = 1.$$

We know that any fixed point u of \bar{T} is a solution of (2.12). Arguing as in the proof of Theorem 1.1 we prove that $\alpha \leq u \leq \beta$ and as α and β are strict $\alpha < u < \beta$. Hence, every fixed point of \bar{T} is in $\Omega \subset B(0, R)$ and using the excision property we obtain

$$\deg(I - T, \Omega) = \deg(I - \bar{T}, \Omega) = 1.$$

Existence of the solution u follows now from the properties of the degree. □

It is easy to deal with \mathcal{A} -Carathéodory functions if we reinforce the notion of strict lower and upper solutions imposing that these functions do not satisfy the boundary conditions.

THEOREM 2.14. *Let α and $\beta \in \mathcal{C}([a, b])$ be strict lower and upper solutions of the problem (2.8) such that*

$$\alpha(a) < 0 < \beta(a), \quad \alpha(b) < 0 < \beta(b) \quad \text{and} \quad \forall t \in]a, b[, \alpha(t) < \beta(t).$$

Define E from (1.2) and assume $f : E \rightarrow \mathbb{R}$ is an \mathcal{A} -Carathéodory function. Then,

$$\deg(I - T, \Omega) = 1,$$

where

$$\Omega = \{u \in \mathcal{C}_0([a, b]) \mid \forall t \in [a, b], \alpha(t) < u(t) < \beta(t)\}$$

and $T : \mathcal{C}_0([a, b]) \rightarrow \mathcal{C}_0([a, b])$ is defined by (2.9). In particular, the problem (2.8) has at least one solution $u \in W^{2,\mathcal{A}}(a, b)$ such that, for all $t \in [a, b]$,

$$\alpha(t) < u(t) < \beta(t).$$

The proof of this result is similar to the proof of Theorem 2.13.

2.3. Non well-ordered lower and upper solutions

We already noticed in Example 1.3 that the method of lower and upper solutions depends strongly on the ordering $\alpha \leq \beta$. On the other hand, lower and upper solutions α, β satisfying the reversed ordering condition $\beta \leq \alpha$ arise naturally in situations where the corresponding problem has a solution. As a very simple example, we can consider the linear problem

$$u'' + \frac{2}{3}u = \sin t, \quad u(0) = u(2\pi), \quad u'(0) = u'(2\pi).$$

The functions $\alpha = \frac{3}{2}$ and $\beta = -\frac{3}{2}$ are lower and upper solutions such that $\alpha \geq \beta$. Notice, however, that the unique solution $u(t) = -3 \sin t$ does not lie between the lower and the upper solution. As we shall see, the reason for this example to work is that the “nonlinearity” $f(t, u) = \sin t - \frac{2}{3}u$ “lies” between the two first eigenvalues of the problem. As a first approach we consider the following result which concerns a nonresonance problem using a bounded perturbation of the linear problem at the first eigenvalue. To simplify, we consider a derivative independent problem.

THEOREM 2.15. *Let α and $\beta \in C([a, b])$ be lower and upper solutions of (2.5) such that $\alpha \not\leq \beta$. Assume $f : [a, b] \times \mathbb{R} \rightarrow \mathbb{R}$ is an L^1 -Carathéodory function and for some $h \in L^1(a, b)$ either*

$$f(t, u) \leq h(t) \quad \text{on } [a, b] \times \mathbb{R}$$

or

$$f(t, u) \geq h(t) \quad \text{on } [a, b] \times \mathbb{R}.$$

Then, there exists a solution u of (2.5) in

$$\mathcal{S} := \{u \in C([a, b]) \mid \exists t_1, t_2 \in [a, b], u(t_1) \geq \beta(t_1), u(t_2) \leq \alpha(t_2)\}. \tag{2.13}$$

PROOF. For each $r > 0$, we define

$$f_r(t, u) = \begin{cases} f(t, u), & \text{if } |u| < r, \\ (1 + r - |u|)f(t, u) + (|u| - r)\frac{u}{r}, & \text{if } r \leq |u| < r + 1, \\ \frac{u}{r}, & \text{if } r + 1 \leq |u|, \end{cases}$$

and consider the problem

$$u'' = f_r(t, u), \quad u(a) = u(b), \quad u'(a) = u'(b). \tag{2.14}$$

Claim. There exists $k > 0$ such that for any $r \geq 2(b - a)^2$, solutions u of (2.14), which are in \mathcal{S} , are such that $\|u\|_\infty \leq k$. Consider the case $f(t, u) \leq h(t)$ on $[a, b] \times \mathbb{R}$. Let $u \in \mathcal{S}$ be a solution of (2.14) and let t_0, t_1 and $t_2 \in [a, b]$ be such that

$$u'(t_0) = 0, \quad u(t_1) \geq \beta(t_1) \geq -\|\beta\|_\infty \quad \text{and} \quad u(t_2) \leq \alpha(t_2) \leq \|\alpha\|_\infty.$$

Extending u by periodicity, we can write for $t \in [t_0, t_0 + b - a]$, and therefore for all $t \in \mathbb{R}$,

$$u'(t) = - \int_t^{t_0+b-a} f_r(s, u(s)) \, ds \geq -\|h\|_{L^1} - \frac{\|u\|_\infty}{2(b-a)}.$$

It follows that for $t \in [t_1, t_1 + b - a]$

$$u(t) = u(t_1) + \int_{t_1}^t u'(s) \, ds \geq -\|\beta\|_\infty - \|h\|_{L^1}(b-a) - \frac{\|u\|_\infty}{2}$$

and for $t \in [t_2 - b + a, t_2]$

$$u(t) = u(t_2) - \int_t^{t_2} u'(s) \, ds \leq \|\alpha\|_\infty + \|h\|_{L^1}(b-a) + \frac{\|u\|_\infty}{2}.$$

Hence, we have

$$\|u\|_\infty \leq 2(\|\alpha\|_\infty + \|\beta\|_\infty + \|h\|_{L^1}(b-a)) =: k.$$

A similar argument holds if $f(t, u) \geq h(t)$.

Conclusion. Consider the problem (2.14), with $r > \max\{k, 2(b - a)^2\}$. It is easy to see that $\alpha_1 = -r - 2$ and $\beta_2 = r + 2$ are lower and upper solutions. Recall that $r \geq \|\alpha\|_\infty + \|\beta\|_\infty$ so that $\alpha_1 < \alpha < \beta_2$ and $\alpha_1 < \beta < \beta_2$.

Assume β is not a strict upper solution. There exists then a solution u of (2.14) such that $u \leq \beta$ and for some $t_1 \in [a, b]$, $u(t_1) = \beta(t_1)$. As further $\alpha \not\leq \beta$, there exists $t_2 \in [a, b]$ such that $\alpha(t_2) > \beta(t_2)$. It follows that $\alpha(t_2) > u(t_2)$, $u \in \mathcal{S}$, and we deduce from the claim that $\|u\|_\infty \leq k$. Hence, u is a solution of (2.5) in \mathcal{S} .

We come to the same conclusion if α is not a strict lower solution.

Suppose now that $\beta_1 = \beta$ and $\alpha_2 = \alpha$ are strict upper and lower solutions. We deduce then from Theorem 2.7 the existence of three solutions of (2.14) one of them, u , being such that for some $t_1, t_2 \in [a, b]$, $u(t_1) > \beta(t_1)$ and $u(t_2) < \alpha(t_2)$. Hence, $u \in \mathcal{S}$ and from the claim $\|u\|_\infty < k$. This implies that u solves (2.5) and proves the theorem. \square

Such a result can be used if we assume some asymptotic control on the quotient $f(t, u)/u$ as $|u|$ goes to infinity. We can generalize further assuming different behaviours as u goes to plus or minus infinity. This is worked out in the following theorem.

THEOREM 2.16. *Let α and $\beta \in \mathcal{C}([a, b])$ be lower and upper solutions of (2.5) such that $\alpha \not\leq \beta$. Let $f : [a, b] \times \mathbb{R} \rightarrow \mathbb{R}$ be an L^1 -Carathéodory function such that for some functions $a_{\pm} \leq 0, b_{\pm} \geq 0$ in $L^1(a, b)$,*

$$a_{\pm}(t) \leq \liminf_{u \rightarrow \pm\infty} \frac{f(t, u)}{u} \leq \limsup_{u \rightarrow \pm\infty} \frac{f(t, u)}{u} \leq b_{\pm}(t),$$

uniformly in $t \in [a, b]$. Assume further that for any $p, q \in L^1(a, b)$, with $a_+ \leq p \leq b_+$ and $a_- \leq q \leq b_-$, the nontrivial solutions of

$$u'' = p(t)u^+ - q(t)u^-, \quad u(a) = u(b), \quad u'(a) = u'(b), \tag{2.15}$$

where $u^+(t) = \max\{u(t), 0\}$ and $u^-(t) = \max\{-u(t), 0\}$, do not have zeros. Then the problem (2.5) has at least one solution $u \in \mathcal{S}$, where \mathcal{S} is defined from (2.13).

PROOF. *Step 1. Claim. There exists $\epsilon > 0$ so that for any $p, q \in L^1(a, b)$, with $a_+ - \epsilon \leq p \leq b_+ + \epsilon$ and $a_- - \epsilon \leq q \leq b_- + \epsilon$, the nontrivial solutions of (2.15) do not have zeros. If the claim were wrong, there would exist sequences $(p_n)_n, (q_n)_n \subset L^1(a, b)$, $(t_n)_n \subset [a, b]$ and $(u_n)_n \subset W^{2,1}(a, b)$ so that $a_+ - 1/n \leq p_n \leq b_+ + 1/n, a_- - 1/n \leq q_n \leq b_- + 1/n$ and u_n is a solution of (2.15) (with $p = p_n$ and $q = q_n$) such that $\|u_n\|_{\mathcal{C}^1} = 1$ and $u_n(t_n) = 0$. Going to subsequences we can assume, using the Dunford–Pettis theorem (see [12]),*

$$p_n \rightharpoonup p, \quad q_n \rightharpoonup q \quad \text{in } L^1(a, b), \quad u_n \rightharpoonup u \quad \text{in } \mathcal{C}^1([a, b]), \quad t_n \rightarrow t_0.$$

It follows that $a_+ \leq p \leq b_+, a_- \leq q \leq b_-$, u is a solution of (2.15) and $u(t_0) = 0$, which contradicts the assumptions.

Step 2. The modified problem. Let us choose $R > 0$ large enough so that

$$a_+ - \epsilon \leq g_+(t, u) = \frac{f(t, u)}{u} \leq b_+ + \epsilon, \quad \text{for } u \geq R,$$

$$a_- - \epsilon \leq g_-(t, u) = \frac{f(t, u)}{u} \leq b_- + \epsilon, \quad \text{for } u \leq -R$$

and extend these functions on $[a, b] \times \mathbb{R}$ so that these inequalities remain valid. As f is L^1 -Carathéodory, there exists $\ell \in L^1(a, b)$ such that

$$f(t, u) = g_+(t, u)u^+ - g_-(t, u)u^- + h(t, u)$$

and

$$|h(t, u)| \leq \ell(t).$$

Next, for each $r \geq 1$, we define

$$g_r^{\pm}(t, u) = \begin{cases} g_{\pm}(t, u), & \text{if } |u| < r, \\ (1 + r - |u|)g_{\pm}(t, u), & \text{if } r \leq |u| < r + 1, \\ 0, & \text{if } r + 1 \leq |u|, \end{cases}$$

$$h_r(t, u) = \begin{cases} h(t, u), & \text{if } |u| < r, \\ (1 + r - |u|)h(t, u), & \text{if } r \leq |u| < r + 1, \\ 0, & \text{if } r + 1 \leq |u|, \end{cases}$$

and consider the modified problem

$$\begin{aligned} u'' + g_r^+(t, u)u^+ - g_r^-(t, u)u^- + h_r(t, u) &= 0, \\ u(a) = u(b), \quad u'(a) = u'(b). \end{aligned} \tag{2.16}$$

Step 3. Claim. There exists $k > 0$ such that, for any $r > k$, solutions u of (2.16), which are in \mathcal{S} , are such that $\|u\|_\infty < k$. Assume by contradiction, there exist sequences $(r_n)_n$ and $(u_n)_n \subset \mathcal{S}$, where $r_n \geq n$ and u_n is a solution of (2.16) (with $r = r_n$) such that $\|u_n\|_\infty \geq n$.

As $u_n \in \mathcal{S}$, there exist sequences $(t_{1n})_n$ and $(t_{2n})_n \subset [a, b]$ such that $u_n(t_{1n}) \geq \beta(t_{1n})$ and $u_n(t_{2n}) \leq \alpha(t_{2n})$.

Consider now the functions $v_n = u_n / \|u_n\|_\infty$ which solve the problems

$$\begin{aligned} v_n'' &= g_{r_n}^+(t, u_n)v_n^+ - g_{r_n}^-(t, u_n)v_n^- + \frac{h_{r_n}(t, u_n)}{\|u_n\|_\infty}, \\ v_n(a) &= v_n(b), \quad v_n'(a) = v_n'(b). \end{aligned}$$

Going to subsequence, we can assume as above

$$\begin{aligned} g_n^+(\cdot, u_n) &\rightharpoonup p, \quad g_n^-(\cdot, u_n) \rightharpoonup q \quad \text{in } L^1(a, b), \\ \frac{h_{r_n}(t, u_n)}{\|u_n\|_\infty} &\rightarrow 0 \quad \text{in } L^1(a, b), \\ v_n &\rightarrow v \quad \text{in } C^1([a, b]), \quad t_{1n} \rightarrow t_1, \quad t_{2n} \rightarrow t_2. \end{aligned}$$

It follows that v satisfies (2.15) and by assumption has no zeros. Hence, we come to a contradiction since $v(t_1) \geq 0$ and $v(t_2) \leq 0$ which implies v has a zero.

Conclusion. We deduce from Theorem 2.15 that (2.16) with $r > \max\{k, \|\alpha\|_\infty, \|\beta\|_\infty\}$ has a solution $u \in \mathcal{S}$ and conclude from Step 3 that u solves (2.5). \square

In the previous theorem we control asymptotically the nonlinearity using the functions a_\pm, b_\pm . Next we impose some admissibility condition on the box $[a_+, b_+] \times [a_-, b_-]$ which is to assume that for any functions $(p, q) \in [a_+, b_+] \times [a_-, b_-]$, the nontrivial solutions of problem (2.15) do not have zeros. Such a condition implies the nonlinearity does not interfere with the second eigenvalue $\lambda_2 = 4(\frac{\pi}{b-a})^2$ of the periodic problem, i.e., $(-\lambda_2, -\lambda_2) \notin [a_+, b_+] \times [a_-, b_-]$. This remark can be made up considering the second curve of the Fučík spectrum. The Fučík spectrum is the set \mathcal{F} of points $(\mu, \nu) \in \mathbb{R}^2$ such that the problem

$$\begin{aligned} u'' + \mu u^+ - \nu u^- &= 0, \\ u(a) = u(b), \quad u'(a) = u'(b), \end{aligned}$$

has nontrivial solutions. From explicit computations of the solution it is easy to see that

$$\mathcal{F} = \bigcup_{n=1}^{\infty} \mathcal{F}_n,$$

where

$$\mathcal{F}_1 = \{(\mu, 0) \mid \mu \in \mathbb{R}\} \cup \{(0, \nu) \mid \nu \in \mathbb{R}\}$$

and

$$\mathcal{F}_n = \left\{ (\mu, \nu) \mid \frac{1}{\sqrt{\mu}} + \frac{1}{\sqrt{\nu}} = \frac{b-a}{\pi(n-1)} \right\}, \quad n = 2, 3, \dots$$

The following proposition relates the admissibility of the box $[a_+, b_+] \times [a_-, b_-]$ with the Fučík spectrum.

PROPOSITION 2.17. *Let $(\mu, \nu) \in \mathcal{F}_2$ and $p, q \in L^1(a, b)$. Assume that for some set $I \subset [a, b]$ of positive measure*

$$\begin{aligned} p(t) &\geq -\mu, & q(t) &\geq -\nu, & \text{for a.e. } t \in [a, b], \\ p(t) &> -\mu, & q(t) &> -\nu, & \text{for a.e. } t \in I. \end{aligned}$$

Then, the nontrivial solutions of problem (2.15) have no zeros.

PROOF. Assume there exists a nontrivial solution u which has a zero. Extend u by periodicity and let t_0 and t_1 be consecutive zeros such that u is positive on $]t_0, t_1[$. Define $v(t) = \sin(\sqrt{\mu}(t - t_0))$ and compute

$$(uv' - vu')\Big|_{t_0}^{t_1} = - \int_{t_0}^{t_1} (p(t) + \mu)u(t)v(t) \, dt.$$

If $t_1 - t_0 < \frac{\pi}{\sqrt{\mu}}$, we come to a contradiction

$$0 < -v(t_1)u'(t_1) \leq 0.$$

Hence $t_1 - t_0 \geq \frac{\pi}{\sqrt{\mu}}$ and we only have equality in case $p(t) = -\mu$ on $[t_0, t_1]$. Similarly, we prove the distance between two consecutive zeros t_1 and t_2 with u negative on $]t_1, t_2[$ is such that $t_2 - t_1 \geq \frac{\pi}{\sqrt{\nu}}$ with equality if and only if $q(t) = -\nu$ on $[t_1, t_2]$. It follows that

$$b - a \geq t_2 - t_0 \geq \frac{\pi}{\sqrt{\mu}} + \frac{\pi}{\sqrt{\nu}} = b - a.$$

This implies $t_2 - t_0 = b - a$, $p(t) = -\mu$ on $[t_0, t_1]$ and $q(t) = -\nu$ on $[t_1, t_2]$ which contradicts the assumptions. □

Existence of several solutions can be obtained using non-well-ordered lower and upper solutions. The following result complements Theorem 2.16.

THEOREM 2.18. *Let α_1 and $\alpha_2 \in C([a, b])$ be lower solutions of (2.5) and $\beta \in C([a, b])$ be a strict upper solution such that $\alpha_2 \not\leq \beta$, $\alpha_1 \leq \alpha_2$ and $\alpha_1 \leq \beta$. Assume $f : [a, b] \times \mathbb{R} \rightarrow \mathbb{R}$ is an L^1 -Carathéodory function such that for some function $b_+ \in L^1(a, b)$,*

$$\limsup_{u \rightarrow +\infty} \frac{f(t, u)}{u} \leq b_+(t),$$

uniformly in $t \in [a, b]$. Then the problem (2.5) has at least two solutions u_1 and u_2 such that

$$\alpha_1 \leq u_1 < \beta, \quad u_2 \in \mathcal{S} \quad \text{and} \quad u_1 \leq u_2,$$

where \mathcal{S} is defined in (2.13) with $\alpha = \alpha_2$.

PROOF. For any $r > \max\{\|\alpha_1\|_\infty, \|\alpha_2\|_\infty, \|\beta\|_\infty\}$, we consider the modified problem

$$u'' = f_r(t, u), \quad u(a) = u(b), \quad u'(a) = u'(b), \tag{2.17}$$

where

$$f_r(t, u) = \begin{cases} f(t, \alpha_1(t)) + u - \alpha_1(t), & \text{if } u \leq \alpha_1(t), \\ f(t, u), & \text{if } \alpha_1(t) < u \leq r, \\ (1 + r - u)f(t, u), & \text{if } r < u \leq r + 1, \\ 0, & \text{if } r + 1 < u. \end{cases}$$

Claim 1. Every solution of (2.17) is such that $u \geq \alpha_1$. This follows from the usual maximum principle argument as it is used, for example, in the proof of Theorem 1.1.

Claim 2. There exists $k > 0$ so that for any $r > \max\{\|\alpha_1\|_\infty, \|\alpha_2\|_\infty, \|\beta\|_\infty\}$ and any solution $u \in \mathcal{S}$ of (2.17), we have $\|u\|_\infty < k$. As $u \in \mathcal{S}$, there exist t_0 and t_1 such that

$$u(t_0) = \min_{t \in [a, b]} u(t) \leq u(t_1) \leq \alpha_2(t_1) \leq \|\alpha_2\|_\infty.$$

Further, we deduce from the asymptotic character of f that there exists \hat{b}_+ and $h \in L^1(a, b)$ such that, for a.e. $t \in [a, b]$ and all $u \geq \alpha_1(t)$,

$$f_r(t, u) \leq \hat{b}_+(t)u + h(t).$$

Hence, we have for $t \in [t_0, t_0 + b - a]$

$$\begin{aligned} u(t) &= u(t_0) + \int_{t_0}^t f_r(s, u(s))(t - s) \, ds \\ &\leq \|\alpha_2\|_\infty + \|h\|_{L^1} (b - a) + (b - a) \int_{t_0}^t \hat{b}_+(s)u(s) \, ds \end{aligned}$$

and the claim follows from Gronwall’s lemma.

Conclusion. Consider the problem (2.17) for

$$r > \max\{\|\alpha_1\|_\infty, \|\alpha_2\|_\infty, \|\beta\|_\infty, k\},$$

where k is given in Claim 2.

It follows from Theorem 1.3 that there exists a solution u_1 of (2.17) which is minimal in $[\alpha_1, \beta]$. Hence, $\alpha_1(t) \leq u_1(t) \leq r$ which implies this solution solves also (2.5).

Next, we can apply Theorem 2.15 to obtain a solution $u_2 \in \mathcal{S}$ of (2.17). From Claim 1, $u_2 \geq \alpha_1$, and from Claim 2, $u_2 \leq k < r$. Therefore u_2 is a solution of (2.5).

Finally, notice that if $u_2 \not\geq u_1$, u_1 and u_2 are upper solutions of (2.17) and we deduce from Theorem 1.2 the existence of a solution u_3 with $\alpha_1 \leq u_3 \leq \min\{u_1, u_2\}$ which contradicts u_1 to be minimal. □

REMARK. We can drop the assumption $\alpha_1 \leq \alpha_2$, but this needs additional work as in the proof of Theorem 1.2.

Dirichlet problem (1.24) can be investigated along the same lines. For example, we can consider the problem of interaction with Fučík spectrum and write a result similar to Theorem 2.16.

THEOREM 2.19. *Assume α and $\beta \in C^1([a, b])$ are lower and upper solutions of (1.24) such that $\alpha \not\leq \beta$. Let $f : [a, b] \times \mathbb{R} \rightarrow \mathbb{R}$ be an L^1 -Carathéodory function such that for some functions $a_\pm \leq -\lambda_1$, $b_\pm \geq -\lambda_1$ in $L^1(a, b)$, where $\lambda_1 = (\frac{\pi}{b-a})^2$*

$$a_\pm(t) \leq \liminf_{u \rightarrow \pm\infty} \frac{f(t, u)}{u} \leq \limsup_{u \rightarrow \pm\infty} \frac{f(t, u)}{u} \leq b_\pm(t),$$

uniformly in $t \in [a, b]$. Assume further that for any $p, q \in L^1(a, b)$, with $a_+ \leq p \leq b_+$ and $a_- \leq q \leq b_-$, the nontrivial solutions of

$$u'' = p(t)u^+ - q(t)u^-, \quad u(a) = 0, \quad u(b) = 0,$$

where $u^+(t) = \max\{u(t), 0\}$ and $u^-(t) = \max\{-u(t), 0\}$, do not have interior zeros. Then the problem (1.24) has at least one solution $u \in \mathcal{S}$, where $\mathcal{S} \subset C_0^1([a, b])$ is the closure in the C^1 -topology of the set

$$\{u \in C_0^1([a, b]) \mid \exists t_1, t_2 \in [a, b], u(t_1) > \beta(t_1), u(t_2) < \alpha(t_2)\}.$$

2.4. Historical and bibliographical notes

In 1972, Amann [5] proved a degree result for boundary value problems with strict lower and upper solutions. He considered the associated fixed point problem $u = Tu$ together with the set Ω of functions u that lie between strict lower and upper solutions and proved

$\deg(I - T, \Omega) = 1$. Until recently, such results were only obtained for continuous nonlinearities.

A study of the Carathéodory case for a Dirichlet problem with f independent of u' can be found in De Coster [27], De Coster, Grossinho and Habets [29], Habets and Omari [48] and De Coster and Habets [30]. The derivative dependent case for a Rayleigh equation is worked out in [52]. Our approach follows these papers. Theorem 2.14 which considers \mathcal{A} -Carathéodory functions can be found in [42].

For the periodic problem we present here the counterpart of similar results for the Dirichlet problem. Theorem 2.5 extends [87], avoiding the assumption $\alpha, \beta \in W^{1,\infty}(a, b)$.

The abstract idea used in the Three Solutions theorem (Theorem 2.7), goes back to Kolesov [66] in 1970 and Amann [4] in 1971. The first one who proved such a result with degree theory seems to be Amann [5] in 1972 (see also [6]). Extensions were also given by Shivaji [98] and Bongsoo Ko [65]. Our result, Theorem 2.7, improves all these in the special case of ODE and extends them to the Carathéodory case. It extends [32] by relaxing the order relations between α_i and β_i .

In 1972, Sattinger [91] presented as an open problem the question of existence of a solution for the problem

$$-\Delta u = f(x, u), \quad \text{in } \Omega, \quad u = 0, \quad \text{on } \partial\Omega, \quad (2.18)$$

in presence of lower and upper solutions which does not satisfy the ordering relation $\alpha \leq \beta$. A first important contribution to this question was given by Amann, Ambrosetti and Mancini [8] in 1978. They consider (2.18) assuming the nonlinearity $f(x, u)$ is a bounded perturbation of $\lambda_1 u$, where λ_1 is the first eigenvalue of the Laplacian. In 1994, Gossez and Omari [45] assumed some asymptotic control on the nonlinearity so that $\frac{f(t,u)}{u}$ remains, within small perturbations, between the two first eigenvalues of the linearized problem. They prove then existence of a solution in presence of a lower and an upper solution without any order relation. More recently, Habets and Omari [48] extended this work providing a general nonresonance condition with respect to the second curve of the Fučík spectrum as in Theorems 2.16 and 2.19. They obtain an existence and localization result in presence of a lower and an upper solution satisfying the reversed order $\alpha > \beta$. Such a condition did not appear in previous works. In [34], this last result was extended by cancelling the reversed order condition as in Theorem 2.19. In [34] the results were obtained for a general elliptic problem. The parabolic case can be found in [35] and the results for the periodic ODE in [36].

3. Variational methods

3.1. The minimization method

Another approach in working with lower and upper solutions is to relate them with variational methods. Consider for example the problem

$$u'' = f(t, u), \quad u(a) = 0, \quad u(b) = 0, \quad (3.1)$$

where f is an L^1 -Carathéodory function. It is well known that the related functional

$$\phi : H_0^1(a, b) \rightarrow \mathbb{R}, \quad u \mapsto \int_a^b \left[\frac{u'^2(t)}{2} + F(t, u(t)) \right] dt,$$

with $F(t, u) = \int_0^u f(t, s) ds$, is of class C^1 and its critical points are the solutions of (3.1). A first link between the two methods is that existence of a well ordered pair of lower and upper solutions α and β , implies the functional ϕ has a minimum on the convex but noncompact set $[\alpha, \beta]$. This minimum solves (3.1).

THEOREM 3.1. *Let α and β be lower and upper solutions of (3.1) with $\alpha \leq \beta$ on $[a, b]$ and E be defined from (1.2). Assume $f : E \rightarrow \mathbb{R}$ is an L^1 -Carathéodory function. Then the functional ϕ is minimum on $[\alpha, \beta]$, i.e., there exists u with $\alpha \leq u \leq \beta$ so that*

$$\phi(u) = \min_{\substack{v \in H_0^1(a, b) \\ \alpha \leq v \leq \beta}} \phi(v).$$

Further, u is a solution of (3.1).

PROOF. Consider the modified problem

$$u'' = f(t, \gamma(t, u)), \quad u(a) = 0, \quad u(b) = 0, \tag{3.2}$$

where $\gamma(t, u)$ is defined from (1.4), and define the functional

$$\bar{\phi} : H_0^1(a, b) \rightarrow \mathbb{R}, \quad u \mapsto \int_a^b \left[\frac{u'^2(t)}{2} + \bar{F}(t, u(t)) \right] dt,$$

where $\bar{F}(t, u) = \int_0^u f(t, \gamma(t, s)) ds$.

Claim 1. $\bar{\phi}$ has a global minimum u which is a solution of (3.2). It is easy to verify that $\bar{\phi}$ is of class C^1 and its critical points are precisely the solutions of (3.2). Moreover $\bar{\phi}$ is weakly lower semicontinuous and coercive. Hence the claim follows.

Claim 2. $\alpha \leq u \leq \beta$. Assume $\min_t (u(t) - \alpha(t)) < 0$ and define $t_0 = \max\{t \in [a, b] \mid u(t) - \alpha(t) = \min_s (u(s) - \alpha(s))\}$. We proceed now as in the proof of Theorem 1.1 and obtain that for any $t \geq t_0$, near enough t_0 ,

$$u'(t) - \alpha'(t) = \int_{t_0}^t (u''(s) - \alpha''(s)) ds = \int_{t_0}^t (f(s, \alpha(s)) - \alpha''(s)) ds \leq 0.$$

This contradicts the definition of t_0 .

Conclusion. Notice that if u is such that $\alpha \leq u \leq \beta$, the difference $\bar{\phi}(u) - \phi(u)$ is a constant independent of u . Hence, both functionals are minimized together between α and β so that the theorem follows from the previous claims. \square

EXAMPLE 3.1. Consider the problem

$$u'' = \lambda f(t, u), \quad u(a) = 0, \quad u(b) = 0, \tag{3.3}$$

where $f : [a, b] \times \mathbb{R} \rightarrow \mathbb{R}$ is an L^1 -Carathéodory function such that $f(t, 0) = 0$, $f(t, R) \geq 0$ for some $R > 0$ and there exists $\mu \in H_0^1(a, b)$, $0 \leq \mu \leq R$ that satisfies $\int_a^b F(t, \mu(t)) dt < 0$ with $F(t, u) = \int_0^u f(t, s) ds$. Then, we can prove the existence of $\Lambda \geq 0$ such that for all $\lambda \geq \Lambda$, (3.3) has, beside the trivial solution, at least one nontrivial nonnegative solution.

We just have to observe that $\alpha = 0$ is a lower solution, $\beta = R$ is an upper solution and $\phi(\mu) < 0$ for λ large enough. Hence, for such values of λ , there exists $u \in [0, R]$ which solves (3.3) and minimizes ϕ on $[0, R]$, i.e.,

$$\phi(u) = \min_{\substack{v \in H_0^1(a, b) \\ 0 \leq v \leq R}} \phi(v) \leq \phi(\mu) < 0 = \phi(0).$$

This last inequality implies $u \neq 0$.

The method applies to other boundary value problems such as the periodic problem

$$u'' = f(t, u), \quad u(a) = u(b), \quad u'(a) = u'(b). \tag{3.4}$$

Here, the associated functional reads

$$\phi : H_{\text{per}}^1(a, b) \rightarrow \mathbb{R}, \quad u \mapsto \int_a^b \left[\frac{u'^2(t)}{2} + F(t, u(t)) \right] dt, \tag{3.5}$$

with $F(t, u) = \int_0^u f(t, s) ds$ and $H_{\text{per}}^1(a, b) = \{u \in H^1(a, b) \mid u(a) = u(b)\}$. For this problem, we can write an equivalent of Theorem 3.1.

THEOREM 3.2. *Let α and β be lower and upper solutions of (3.4) with $\alpha \leq \beta$ on $[a, b]$ and E be defined from (1.2). Assume $f : E \rightarrow \mathbb{R}$ is an L^1 -Carathéodory function. Then the functional ϕ defined by (3.5) is minimum on $[\alpha, \beta]$, i.e., there exists u with $\alpha \leq u \leq \beta$ so that*

$$\phi(u) = \min_{\substack{v \in H_{\text{per}}^1(a, b) \\ \alpha \leq v \leq \beta}} \phi(v).$$

Further, u is a solution of (3.4).

PROOF. The proof of this result follows the argument of the proof of Theorem 3.1. □

As an application of Theorem 3.1, consider the problem

$$u'' + \mu(t)g(u) + h(t) = 0, \quad u(0) = 0, \quad u(\pi) = 0. \tag{3.6}$$

THEOREM 3.3. *Let $\mu, h \in L^\infty(0, \pi)$ and suppose $\mu_0 = \text{essinf } \mu(t) > 0$. Assume $g : \mathbb{R} \rightarrow \mathbb{R}$ is a continuous function, $G(u) = \int_0^u g(s) \, ds$,*

$$-\infty < \liminf_{u \rightarrow \pm\infty} \frac{G(u)}{u^2} \leq 0 \quad \text{and} \quad \limsup_{u \rightarrow \pm\infty} \frac{G(u)}{u^2} = +\infty.$$

Then the problem (3.6) has two infinite sequences of solutions $(u_n)_n$ and $(v_n)_n$ satisfying

$$\dots \leq v_{n+1} \leq v_n \leq \dots \leq v_1 \leq u_1 \leq \dots \leq u_n \leq u_{n+1} \leq \dots$$

and

$$\lim_{n \rightarrow \infty} \left(\max_t u_n(t) \right) = +\infty, \quad \lim_{n \rightarrow \infty} \left(\min_t v_n(t) \right) = -\infty.$$

PROOF. *Step 1. Claim. For every $M \geq 0$ there exists β , an upper solution of (3.6), with $\beta(t) \geq M$ on $[0, \pi]$. First observe that, if g is unbounded from below on $[0, +\infty[$, we have a sequence of constant upper solutions $\beta_n \rightarrow +\infty$. In the opposite case, we can assume there exists $K \geq 0$ such that $g(u) \geq -K$ for $u \geq 0$.*

Given $M > 0$, we can choose d so that

$$\|\mu\|_\infty \left(\frac{G(d)}{d^2} + \frac{K}{d} \right) + \frac{\|h\|_\infty}{d} \leq \frac{1}{8\pi^2} \quad \text{and} \quad d > 2M.$$

We define then β to be the solution of the Cauchy problem

$$u'' + \|\mu\|_\infty (g(u) + K) + \|h\|_\infty = 0, \quad u(0) = d, \quad u'(\pi) = 0. \tag{3.7}$$

Assume there exists $t_0 \in]0, \pi[$ such that $\beta(t) > M$ on $[0, t_0[$ and $\beta(t_0) = M$. Notice that on $[0, t_0]$, $\beta'(t) \leq 0$ and $\|\mu\|_\infty (G(\beta(t)) + K\beta(t)) + \|h\|_\infty \beta(t) \geq 0$. From the conservation of energy for (3.7), we have

$$\begin{aligned} \frac{\beta'^2(t)}{2} &\leq \frac{\beta'^2(t)}{2} + \|\mu\|_\infty (G(\beta(t)) + K\beta(t)) + \|h\|_\infty \beta(t) \\ &= \|\mu\|_\infty (G(d) + Kd) + \|h\|_\infty d \leq \frac{d^2}{8\pi^2}, \end{aligned}$$

i.e.,

$$0 \leq -\beta'(t) \leq \frac{d}{2\pi}.$$

It follows that for any $t \in [0, t_0]$,

$$d - \beta(t) \leq \frac{d}{2\pi} t_0 \leq \frac{d}{2},$$

which leads to the contradiction $\beta(t_0) \geq \frac{d}{2} > M$. Hence, the claim follows.

In a similar way, we prove the following.

Claim. For every $M \geq 0$ there exists a lower solution α of (3.6) such that $\alpha(t) \leq -M$ on $[0, \pi]$.

Step 2. Claim. There exist a sequence of positive real numbers $(s_n)_n$ with $s_n \rightarrow +\infty$ and $z > 0$ such that $\phi(s_n z) \rightarrow -\infty$. Define z to be a C^1 -function such that $0 < z(t) \leq 1$ on $[0, \pi]$, $z(0) = 0$, $z(\pi) = 0$, $z'(0) > 0$, $z'(\pi) < 0$ and $z(t) = 1$ on $[\epsilon, \pi - \epsilon]$ for some $\epsilon > 0$. Choose $(s_n)_n$ a sequence of positive real numbers with $s_n \rightarrow +\infty$ and $\frac{G(s_n)}{s_n^2} \rightarrow +\infty$.

Recall that the assumptions imply $G(u) \geq -K(u^2 + 1)$, for some $K > 0$. We compute then

$$\begin{aligned} \phi(s_n z) &= \int_0^\pi \left[\frac{s_n^2 z'^2(t)}{2} - \mu(t)G(s_n z(t)) - h(t)s_n z(t) \right] dt \\ &= \int_{[0, \pi] \setminus [\epsilon, \pi - \epsilon]} \frac{s_n^2 z'^2(t)}{2} dt - G(s_n) \int_\epsilon^{\pi - \epsilon} \mu(t) dt \\ &\quad - \int_{[0, \pi] \setminus [\epsilon, \pi - \epsilon]} \mu(t)G(s_n z(t)) dt - s_n \int_0^\pi h(t)z(t) dt \\ &\leq s_n^2 \|z'\|_\infty^2 \epsilon - G(s_n) \mu_0 (\pi - 2\epsilon) + K(s_n^2 + 1) \|\mu\|_{L^1} + s_n \|h\|_{L^1} \|z\|_\infty. \end{aligned}$$

It follows that $\phi(s_n z) \rightarrow -\infty$.

Step 3. Claim. There exist a sequence of negative real numbers $(t_n)_n$ with $t_n \rightarrow -\infty$ and $z > 0$ such that $\phi(t_n z) \rightarrow -\infty$. The argument is similar to Step 2.

Step 4. Conclusion. By Step 1, we have α_1, β_1 lower and upper solutions of (3.6) with $\alpha_1 \leq \beta_1$. Hence, we obtain from Theorem 3.1 a solution u_1 of (3.6) such that $\alpha_1 \leq u_1 \leq \beta_1$.

From Step 2, we have z and s_1 such that $s_1 z \geq u_1$ and $\phi(s_1 z) < \phi(u_1)$. Moreover, Step 1 provides the existence of an upper solution β_2 with $u_1 \leq s_1 z \leq \beta_2$. Now, by Theorem 3.1, we have a solution u_2 of (3.6) satisfying

$$u_1 \leq u_2 \leq \beta_2$$

and

$$\phi(u_2) = \min_{\substack{v \in H_0^1(a,b) \\ u_1 \leq v \leq \beta_2}} \phi(v) \leq \phi(s_1 z) < \phi(u_1).$$

It follows that $u_2 \neq u_1$.

Iterating this argument and reproducing it in the negative part, we prove the result. \square

REMARK 3.1. The condition on $G(u)/u^2$ cannot be replaced by analogous conditions on $g(u)/u$ (see [39]).

As a next problem consider the following prescribed mean curvature problem

$$\left(\frac{u'}{\sqrt{1 + u'^2}} \right)' = \lambda f(t, u), \quad u(0) = 0, \quad u(1) = 0. \tag{3.8}$$

This equation is equivalent to

$$u'' = \lambda(1 + u'^2)^{3/2} f(t, u), \quad u(0) = 0, \quad u(1) = 0.$$

As in Example 3.1, the following result provides a nontrivial nonnegative solution. Notice however that the equation does not satisfy a Nagumo condition which will force us to modify not only the dependence in u but also in the derivative u' .

PROPOSITION 3.4. *Let $f : [0, 1] \times \mathbb{R} \rightarrow \mathbb{R}$ be a continuous function such that $f(t, 0) \leq 0$ and define $F(t, u) = \int_0^u f(t, s) ds$. Assume that for some $[a, b] \subset]0, 1[$, $a \neq b$,*

$$\lim_{u \rightarrow 0^+} \left[\max_{t \in [a, b]} \frac{F(t, u)}{u^2} \right] = -\infty. \tag{3.9}$$

Then there exists $\lambda^* > 0$ such that, for each $\lambda \in]0, \lambda^*[$, problem (3.8) has a nontrivial, nonnegative solution.

PROOF. *The modified problem.* Define

$$p(s) = \begin{cases} (1 + s)^{-1/2}, & \text{if } 0 \leq s < 1, \\ \frac{1}{8\sqrt{2}}[(s - 2)^2 + 7], & \text{if } 1 \leq s < 2, \\ \frac{7}{8\sqrt{2}}, & \text{if } 2 \leq s, \end{cases}$$

$\alpha(t) = 0$ and $\beta(t) = t(1 - t)$. Consider then the functional $\phi : H_0^1(0, 1) \rightarrow \mathbb{R}$, defined by

$$\phi(u) = \int_0^1 \left[\frac{1}{2} P(u'^2) + \lambda \bar{F}(t, u(t)) \right] dt,$$

where $P(v) = \int_0^v p(s) ds$, $\bar{F}(t, u) = \int_0^u f(t, \gamma(t, s)) ds$ and γ is defined from (1.4). Critical points of ϕ solve

$$(p(u'^2)u')' = \lambda f(t, \gamma(t, u)), \quad u(0) = 0, \quad u(1) = 0,$$

which can also be written

$$u'' = \lambda(p(u'^2) + 2p'(u'^2)u'^2)^{-1} f(t, \gamma(t, u)), \quad u(0) = 0, \quad u(1) = 0. \tag{3.10}$$

Notice at last that $p(s) + 2p'(s)s \geq \frac{19}{40\sqrt{2}}$.

Claim 1. *Existence for small values of λ of a solution $u_{\min} \in [0, \beta]$ of (3.10) such that*

$$\phi(u_{\min}) = \min_{\substack{v \in H_0^1(0, 1) \\ 0 \leq v \leq \beta}} \phi(v).$$

Notice that $\alpha = 0$ is a lower solution. Further, for $\lambda > 0$ small enough, β is an upper solution of (3.10). The claim follows now from an argument similar to the proof of Theorem 3.1.

Claim 2. $\phi(u_{\min}) < \phi(0)$. Let $\zeta \in C_0^1([0, 1])$ be such that $\zeta(t) = 0$ on $[0, a] \cup [b, 1]$ and $\zeta(t) \in]0, 1[$ on $]a, b[$. From (3.9), we deduce the existence of a sequence $(c_n)_n \subset \mathbb{R}^+$ such that

$$\lim_{n \rightarrow \infty} c_n = 0 \quad \text{and} \quad \text{for all } x \in]0, c_n[, \quad \max_{t \in [a, b]} \frac{F(t, x)}{x^2} \leq \max_{t \in [a, b]} \frac{F(t, c_n)}{c_n^2}.$$

Hence, for n large enough

$$\begin{aligned} \phi(c_n \zeta) &= \int_0^1 \sqrt{1 + c_n^2 |\zeta'|^2} \, dt + \int_a^b \lambda F(\cdot, c_n \zeta) \, dt - 1 \\ &\leq c_n^2 \left(\int_0^1 \frac{1}{c_n^2} (\sqrt{1 + c_n^2 |\zeta'|^2} - 1) \, dt + \lambda \max_{t \in [a, b]} \frac{F(t, c_n)}{c_n^2} \int_a^b \zeta^2 \, dt \right) \\ &< 0 = \phi(0). \end{aligned}$$

The claim follows.

Claim 3. For $\lambda > 0$ small enough, u_{\min} is a solution of (3.8). There exists $K > 0$ so that solutions of (3.10) are such that $\|u''\|_\infty \leq K\lambda$. Hence for $\lambda > 0$ small enough, $\|u'_{\min}\|_\infty \leq 1$ and the claim follows. \square

3.2. The minimax method

The minus gradient flow

One of the main techniques in variational methods uses the deformation of paths or surfaces along the minus gradient (or pseudo-gradient) flow. In this section, we study the dynamical system associated with such a flow.

We shall define the minus gradient flow using the following assumptions:

- (H) Let $f : [a, b] \times \mathbb{R} \rightarrow \mathbb{R}$, $(t, u) \mapsto f(t, u)$ be an L^1 -Carathéodory function, locally Lipschitz in u . Let also $m \in L^1(a, b)$ be such that $m > 0$ a.e. in $[a, b]$ and $f(t, u) - m(t)u$ is decreasing in u .

Now, let us define on $H_0^1(a, b)$ the scalar product

$$(u, v)_{H_0^1} = \int_a^b [u'(t)v'(t) + m(t)u(t)v(t)] \, dt$$

and let

$$F(t, u) = \int_0^u f(t, s) \, ds.$$

It is then easy to see that the functional

$$\phi : H_0^1(a, b) \rightarrow \mathbb{R}, \quad u \mapsto \int_a^b \left[\frac{u'^2(t)}{2} + F(t, u(t)) \right] dt$$

is of class C^1 and

$$\nabla \phi(u) = u - KN(u), \tag{3.11}$$

where

$$\begin{aligned} N : H_0^1(a, b) &\rightarrow L^1(a, b), & u &\mapsto f(\cdot, u) - m(\cdot)u, \\ K : L^1(a, b) &\rightarrow H_0^1(a, b), & h &\mapsto Kh \end{aligned} \tag{3.12}$$

and Kh is defined to be the unique solution of

$$u'' - m(t)u = h(t), \quad u(a) = 0, \quad u(b) = 0.$$

Let us notice at last that if assumptions (H) are satisfied, the function

$$\nabla \phi : C_0^1([a, b]) \rightarrow C_0^1([a, b]),$$

defined from (3.11), is a locally Lipschitzian function. Next, we define for any $r \in \mathbb{R}$ a C^1 -function $\psi_r : \mathbb{R} \rightarrow [0, 1]$ such that $\psi_r(s) = 1$ if $s \geq r$ and $\psi_r(s) = 0$ if $s \leq r - 1$.

We consider then the Cauchy problem

$$\frac{d}{dt}u = -\psi_r(\phi(u))\nabla \phi(u) = -\psi_r(\phi(u))(u - KN(u)), \quad u(0) = u_0, \tag{3.13}$$

where $u_0 \in C_0^1([a, b])$. From the theory of ordinary differential equations, we know that the solution $u(\cdot; u_0)$ of (3.13) exists, is unique and is defined in the future on a maximal interval $[0, \omega(u_0)[$. We also know that for any $t \in [0, \omega(u_0)[$, the function $u(t; \cdot) : C_0^1([a, b]) \rightarrow C_0^1([a, b])$ is continuous. We call the *minus gradient flow* the local semi-dynamical system defined on $C_0^1([a, b])$ by $u(t; u_0)$.

We could have defined the minus gradient flow in $X = C_0([a, b])$ or $H_0^1(a, b)$. However, such choices are not suitable in our context. We have to work with sets such as $\{u \in X \mid u < \beta\}$ and $\{u \in X \mid u > \alpha\}$, where α and β are lower and upper solutions that satisfy the boundary conditions. With the $C_0([a, b])$ or the $H_0^1(a, b)$ -topology, these sets have empty interior which creates major difficulties.

A first result shows that the solutions of (3.13) are defined for all $t \geq 0$.

PROPOSITION 3.5. *Let assumptions (H) be satisfied and $u(t; u_0)$ be the minus gradient flow defined for some $r \in \mathbb{R}$. Then for any $u_0 \in C_0^1([a, b])$, we have $\omega(u_0) = +\infty$.*

PROOF. Notice that

$$\begin{aligned} \frac{d}{dt}\phi(u(t; u_0)) &= \left(\nabla\phi(u(t; u_0)), \frac{d}{dt}u(t; u_0) \right)_{H_0^1} \\ &= -\psi_r(\phi(u(t; u_0))) \|\nabla\phi(u(t; u_0))\|_{H_0^1}^2, \end{aligned}$$

which implies that for all $t \in [0, \omega(u_0)[$

$$\phi(u(t; u_0)) \leq \phi(u_0). \tag{3.14}$$

Observe also that $\phi(u(t; u_0)) \geq \min\{r - 1, \phi(u_0)\} =: C$. Finally we have for any $0 \leq t_1 < t_2 < \omega(u_0)$

$$\begin{aligned} &\|u(t_2; u_0) - u(t_1; u_0)\|_{H_0^1} \\ &\leq \int_{t_1}^{t_2} \psi_r(\phi(u(s; u_0))) \|\nabla\phi(u(s; u_0))\|_{H_0^1} ds \\ &\leq \left[\int_{t_1}^{t_2} \psi_r(\phi(u(s; u_0))) \|\nabla\phi(u(s; u_0))\|_{H_0^1}^2 ds \right]^{\frac{1}{2}} \left[\int_{t_1}^{t_2} \psi_r(\phi(u(s; u_0))) ds \right]^{\frac{1}{2}} \\ &\leq \left[- \int_{t_1}^{t_2} \frac{d}{ds}\phi(u(s; u_0)) ds \right]^{\frac{1}{2}} \sqrt{t_2 - t_1} \leq [\phi(u_0) - C]^{\frac{1}{2}} \sqrt{t_2 - t_1}. \end{aligned}$$

Hence, if $\omega(u_0) < +\infty$, there exists $u^* \in H_0^1(a, b)$ such that $u(t; u_0) \xrightarrow{H_0^1} u^*$ as $t \rightarrow \omega(u_0)$. It follows that the function $u(\cdot; u_0) : [0, \omega(u_0)] \rightarrow \mathcal{C}([a, b])$, where $u(\omega(u_0); u_0) = u^*$, is continuous and $KNu(\cdot; u_0) \in \mathcal{C}([0, \omega(u_0)], \mathcal{C}_0^1([a, b]))$. Let $a(t) = \psi_r(\phi(u(t; u_0)))$. For all $t \in [0, \omega(u_0)]$, we can write

$$u(t; u_0) = u_0 e^{-\int_0^t a(r) dr} + \int_0^t e^{-\int_s^t a(r) dr} a(s) KNu(s; u_0) ds \in \mathcal{C}_0^1([a, b]).$$

Hence, $u(\cdot; u_0) : [0, \omega(u_0)] \rightarrow \mathcal{C}_0^1([a, b])$ is continuous, which implies

$$u(t; u_0) \xrightarrow{\mathcal{C}_0^1} u^* \quad \text{as } t \rightarrow \omega(u_0).$$

This contradicts the maximality of $\omega(u_0)$. □

Invariant sets

An important property of the cones

$$C_\alpha = \{u \in \mathcal{C}_0^1([a, b]) \mid u > \alpha\} \tag{3.15}$$

and

$$C^\beta = \{u \in C_0^1([a, b]) \mid u < \beta\}, \tag{3.16}$$

which are associated to lower and upper solutions α and β for (3.1), is that they are positively invariant. To make this precise, let us introduce the following definitions.

DEFINITION 3.1. Let $u(t; u_0)$ be the minus gradient flow defined for some $r \in \mathbb{R}$. A non-empty set $M \subset C_0^1([a, b])$ is called a *positively invariant set* if

$$\forall u_0 \in M, \forall t \geq 0, \quad u(t; u_0) \in M.$$

As a first example, notice that (3.14) implies that the set

$$\phi^c = \{u \in C_0^1([a, b]) \mid \phi(u) < c\}$$

is positively invariant. Also, unions and intersections of positively invariant sets are positively invariant.

To investigate the positive invariance of the cones C_α and C^β defined by (3.15) and (3.16), we need the following lemma.

LEMMA 3.6. *Let assumptions (H) be satisfied. Assume $\alpha \in W^{2,1}(a, b)$ is a lower solution of (3.1). Then for all $u \geq \alpha$, we have $KNu \geq \alpha$, where K and N are defined by (3.12).*

PROOF. Let $u \geq \alpha$, set $w = KNu - \alpha$ and observe that w satisfies

$$\begin{aligned} w'' - m(t)w &= (KNu)''(t) - m(t)(KNu)(t) - (\alpha''(t) - m(t)\alpha(t)) \\ &\leq f(t, u(t)) - m(t)u(t) - (f(t, \alpha(t)) - m(t)\alpha(t)) \leq 0, \\ w(a) &\geq 0, \quad w(b) \geq 0. \end{aligned}$$

It follows that $w \geq 0$. □

PROPOSITION 3.7. *Let assumptions (H) be satisfied and $u(t; u_0)$ be the minus gradient flow defined for some $r \in \mathbb{R}$. If $\alpha \in W^{2,1}(a, b)$ is a lower solution of (3.1), the set C_α defined by (3.15) is positively invariant. Similarly, if $\beta \in W^{2,1}(a, b)$ is an upper solution of (3.1), the set C^β defined by (3.16) is positively invariant.*

PROOF. If the claim is wrong, we can find $u_0 \in C_\alpha$ and $t_1 > 0$ so that for all $t \in [0, t_1[$, $u(t; u_0) \in C_\alpha$ and $u(t_1; u_0) \in \partial C_\alpha$.

Let $w(t) = u(t; u_0) - \alpha$, define $a(t) = \psi_r(\phi(u(t; u_0)))$ and observe that for all $t \in [0, t_1[$

$$\frac{d}{dt}w(t) = \frac{d}{dt}u(t; u_0) = -a(t)(u(t, u_0) - KN(u(t; u_0))) = -a(t)w(t) + h(t),$$

where from Lemma 3.6 and for $t \in [0, t_1[$, $h(t) = a(t)(KN(u(t; u_0)) - \alpha) \geq 0$. As $w(0) = u_0 - \alpha > 0$ we have

$$w(t_1) = w(0)e^{-\int_0^{t_1} a(r) dr} + \int_0^{t_1} e^{-\int_s^{t_1} a(r) dr} h(s) ds > 0,$$

which contradicts $u(t_1; u_0) \in \partial C_\alpha$. □

Non-well-ordered lower and upper solutions

The first result of this section provides Palais–Smale type sequences from non-well-ordered lower and upper solutions. As usual, this gives a solution of (3.1) with the help of a Palais–Smale type condition.

PROPOSITION 3.8. *Let assumptions (H) be satisfied. Suppose α and $\beta \in W^{2,1}(a, b)$ are lower and upper solutions of (3.1) and $\alpha \not\leq \beta$. Define C_α and C^β from (3.15) and (3.16),*

$$\begin{aligned} \Gamma &= \{ \gamma \in \mathcal{C}([0, 1], \mathcal{C}_0^1([a, b])) \mid \gamma(0) \in C^\beta, \gamma(1) \in C_\alpha \}, \\ T_\gamma &= \{ s \in [0, 1] \mid \gamma(s) \in \mathcal{C}_0^1([a, b]) \setminus (C^\beta \cup C_\alpha) \}, \end{aligned} \tag{3.17}$$

and assume

$$c := \inf_{\gamma \in \Gamma} \max_{s \in T_\gamma} \phi(\gamma(s)) \in \mathbb{R}.$$

Finally, let $u(t; u_0)$ be the minus gradient flow defined with $r = c - 1$. Then, for any $\delta \in]0, 1[$ there exists $u_0 \in \mathcal{C}_0^1([a, b])$ such that

$$\forall t > 0, \quad u(t; u_0) \in \phi^{-1}([c - \delta, c + \delta]) \setminus (C^\beta \cup C_\alpha)$$

and there exists an increasing unbounded sequence $(t_n)_n \subset \mathbb{R}^+$ such that

$$\nabla \phi(u(t_n; u_0)) \xrightarrow{H_0^1} 0 \quad \text{as } n \rightarrow \infty.$$

PROOF. Let us fix $\delta \in]0, 1[$ and define $E = \phi^{c-\delta} \cup C_\alpha \cup C^\beta$. Observe that E is positively invariant. Define $A(E) = \{u_0 \in \mathcal{C}_0^1([a, b]) \mid \exists t \geq 0, u(t; u_0) \in E\}$. Obviously, this set is open and positively invariant.

Consider a path $\gamma \in \Gamma$ so that $c \leq \max_{s \in T_\gamma} \phi(\gamma(s)) \leq c + \delta$.

Claim. There exists $u_0 \in \gamma(T_\gamma) \setminus A(E)$. Assume by contradiction that for every $s \in T_\gamma$, $\gamma(s) \in A(E)$, i.e., that for every $s \in [0, 1]$, $\gamma(s) \in A(E)$.

Let us prove first that in such a case there exists $T \geq 0$ such that for all $s \in [0, 1]$, $u(T; \gamma(s)) \in E$. For any $s \in [0, 1]$, we can find $t_s \geq 0$ such that $u(t_s; \gamma(s)) \in E$. Assume next that for every $n \in \mathbb{N}$, there exists $s_n \in [0, 1]$ such that $u(n, \gamma(s_n)) \notin E$. Going to a subsequence, we can assume $s_n \rightarrow s^* \in [0, 1]$ and, using the contradiction assumption, there exists $t_{s^*} \geq 0$ such that $u(t_{s^*}; \gamma(s^*)) \in E$. As E is open, for all n large

enough $u(t_{s^*}; \gamma(s_n)) \in E$ which leads to a contradiction as E is positively invariant and $u(n; \gamma(s_n)) \notin E$.

Notice now that $u(T; \gamma(\cdot))$ is in Γ and such that $\phi(u(T; \gamma(\cdot))) \leq c - \delta$ on T_γ which contradicts the definition of c .

Conclusion. By construction of $A(E)$ and as $\phi(u(\cdot; u_0))$ is decreasing, we have for all $t > 0$, $u(t; u_0) \in \phi^{-1}([c - \delta, c + \delta]) \setminus (C^\beta \cup C_\alpha)$. Hence, u satisfies

$$\frac{d}{dt}u = -\nabla\phi(u)$$

and there exists an increasing unbounded sequence $(t_n)_n$ which verifies

$$\frac{d}{dt}\phi(u(t_n; u_0)) = -\|\nabla\phi(u(t_n; u_0))\|_{H_0^1}^2 \rightarrow 0.$$

□

In order to obtain existence of solutions of (3.1), we need to prove that the sequence $(u(t_n; u_0))_n$ converges towards such a solution. This holds true in case we assume a Palais–Smale condition.

THE PALAIS–SMALE CONDITION. *For every $(u_n)_n \subset H_0^1(a, b)$ such that*

$$\phi(u_n) \text{ is bounded and } \nabla\phi(u_n) \xrightarrow{H_0^1} 0,$$

there exists a subsequence that converges in $H_0^1(a, b)$ to some function u such that $\nabla\phi(u) = 0$.

It is known that, under our assumptions, the Palais–Smale condition is easy to verify if $\phi(u)$ is coercive or more generally if the Palais–Smale sequences $(u_n)_n$ are bounded in $H_0^1(a, b)$.

Our next result is an existence result that uses the Palais–Smale condition.

THEOREM 3.9. *Let assumptions (H) be satisfied. Suppose α and $\beta \in W^{2,1}(a, b)$ are lower and upper solutions of (3.1) and $\alpha \not\leq \beta$. Define Γ and T_γ as in (3.17) and assume*

$$c := \inf_{\gamma \in \Gamma} \max_{s \in T_\gamma} \phi(\gamma(s)) \in \mathbb{R}.$$

Finally, assume that the Palais–Smale condition is satisfied. Then there exists $v \in C_0^1([a, b]) \setminus (C^\beta \cup C_\alpha)$ a solution of (3.1) such that $\phi(v) = c$.

PROOF. Let $u(t; u_0)$ be the minus gradient flow defined with $r = c - 1$.

Part 1. *For any $k \in \mathbb{N}$, there exists $v_k \in H_0^1(a, b)$ such that*

$$c - \frac{1}{k} \leq \phi(v_k) \leq c + \frac{1}{k} \quad \text{and} \quad \nabla\phi(v_k) = 0.$$

Let us fix $k \in \mathbb{N}$. From Proposition 3.8, there exists $u_k \in C_0^1([a, b])$ such that

$$\forall t > 0, \quad u(t; u_k) \in \phi^{-1}\left(\left[c - \frac{1}{k}, c + \frac{1}{k}\right]\right) \setminus (C^\beta \cup C_\alpha),$$

and there exists an increasing unbounded sequence $(t_n)_n \subset \mathbb{R}^+$ such that

$$\nabla\phi(u(t_n; u_k)) \xrightarrow{H_0^1} 0 \quad \text{as } n \rightarrow \infty.$$

Notice that $\phi(u(t; u_k)) > c - 1$ so that $u(t; u_k)$ solves

$$\frac{d}{dt}u = -\nabla\phi(u), \quad u(0) = u_k.$$

Using the Palais–Smale condition, we can find a subsequence that we still write $(u(t_n; u_k))_n$ and $v_k \in H_0^1(a, b)$ such that

$$\begin{aligned} u(t_n; u_k) &\xrightarrow{H_0^1} v_k \quad \text{as } n \rightarrow \infty, \\ c - \frac{1}{k} &\leq \phi(v_k) \leq c + \frac{1}{k} \quad \text{and} \quad \nabla\phi(v_k) = 0. \end{aligned}$$

Part 2. $v_k \in C_0^1([a, b]) \setminus (C^\beta \cup C_\alpha)$.

Claim 1. There exists $R > 0$ such that for all $s \in [0, +\infty[$,

$$\|u(s; u_k)\|_{H_0^1} \geq R \quad \text{implies} \quad \|\nabla\phi(u(s; u_k))\|_{H_0^1} \geq \frac{1}{R}.$$

If not, there exists a sequence $(s_m)_m \subset [0, +\infty[$ such that

$$\|u(s_m; u_k)\|_{H_0^1} \geq m \tag{3.18}$$

and $\|\nabla\phi(u(s_m; u_k))\|_{H_0^1} \leq \frac{1}{m}$. As $\phi(u(t; u_k))$ is bounded, by the Palais–Smale condition, there exists a subsequence $(s_{m_j})_j$ so that $u(s_{m_j}; u_k)$ converges in $H_0^1(a, b)$ which contradicts (3.18).

Claim 2. $\|u(t; u_k)\|_{H_0^1}$ is bounded on \mathbb{R}^+ . Assume that for some $t > 0$, $\|u(t; u_k)\|_{H_0^1} > R_0 = \max\{\|u_k\|_{H_0^1}, R\}$. Then there exists $t_1 \in [0, t]$ so that $\|u(t_1; u_k)\|_{H_0^1} = R_0$ and for any $s \in [t_1, t]$, $\|u(s; u_k)\|_{H_0^1} \geq R_0 \geq R$. It follows that

$$|\phi(u(t; u_k)) - \phi(u(t_1; u_k))| = \int_{t_1}^t \|\nabla\phi(u(s; u_k))\|_{H_0^1}^2 ds \geq \frac{1}{R^2}(t - t_1).$$

On the other hand, we have

$$\|u(t; u_k) - u(t_1; u_k)\|_{H_0^1}$$

$$\begin{aligned}
 &= \left\| \int_{t_1}^t \nabla \phi(u(s; u_k)) \, ds \right\|_{H_0^1} \\
 &\leq \left[\int_{t_1}^t \|\nabla \phi(u(s; u_k))\|_{H_0^1}^2 \, ds \right]^{\frac{1}{2}} (t - t_1)^{\frac{1}{2}} \\
 &= |\phi(u(t; u_k)) - \phi(u(t_1; u_k))|^{\frac{1}{2}} (t - t_1)^{\frac{1}{2}} \\
 &\leq |\phi(u(t; u_k)) - \phi(u(t_1; u_k))| R.
 \end{aligned}$$

As $\phi(u(t; u_k))$ is bounded, the claim follows.

Claim 3. $v_k \in C_0^1([a, b]) \setminus (C^\beta \cup C_\alpha)$. To prove this claim let us show that for some subsequence $u(t_n; u_k) \xrightarrow{C_0^1} v_k$. Consider the sequence $(w_n)_n \subset C_0^1([a, b])$, defined by

$$w_n(r) = \int_0^{t_n} e^{-(t_n-s)} (K N u(s; u_k))(r) \, ds,$$

with K and N defined from (3.12). As $\|u(t; u_k)\|_{H_0^1}$ is bounded, there exists $h \in L^1(a, b)$ so that

$$\begin{aligned}
 |w_n''(r)| &= \left| \int_0^{t_n} e^{-(t_n-s)} [f(\cdot, u(s; u_k)) - m(\cdot)(u(s; u_k) - K N u(s; u_k))](r) \, ds \right| \\
 &\leq \int_0^{t_n} e^{-(t_n-s)} h(r) \, ds \leq h(r).
 \end{aligned}$$

Using the Arzelà–Ascoli theorem, we can find a subsequence $(w_{n_i})_i$ converging in $C_0^1([a, b])$. The same holds true for

$$u(t_n; u_k) = u_k e^{-t_n} + \int_0^{t_n} e^{-(t_n-s)} K N u(s; u_k) \, ds,$$

i.e.,

$$u(t_{n_i}; u_k) \xrightarrow{C_0^1} v_k$$

and the claim follows.

Conclusion. From the Palais–Smale condition, a subsequence of $(v_k)_k$ converges in $H_0^1(a, b)$ to some function v . As $v_k = K N v_k$, the convergence also holds in $C_0^1([a, b])$, i.e.,

$$v \in C_0^1([a, b]) \setminus (C^\beta \cup C_\alpha), \quad \phi(v) = c \quad \text{and} \quad \nabla \phi(v) = 0.$$

□

A four solutions theorem

This section deals with a problem (3.1) which has the trivial solution $u = 0$. We consider assumptions which imply existence of lower and upper solutions α_i, β_i so that

$$\alpha_1 \leq \beta_1 \leq 0 \leq \alpha_2 \leq \beta_2.$$

The Three Solution theorem (see Theorem 2.7 for the periodic case) will provide three solutions, two one-sign ones $u_1 \in [\alpha_1, \beta_1]$ and $u_2 \in [\alpha_2, \beta_2]$ and a third one that can be the zero solution. The difficulty is to obtain a third nontrivial solution. Here such a result is obtained assuming the slope $\frac{f(t,u)}{u}$ crosses the two first eigenvalues.

THEOREM 3.10. *Let assumptions (H) be satisfied and assume:*

- (i) *there exist $\lambda > \lambda_2 = \frac{4\pi^2}{(b-a)^2}$ and $\delta > 0$ such that for a.e. $t \in [a, b]$ and all $u \in [-\delta, \delta]$,*

$$\frac{f(t, u)}{u} \leq -\lambda;$$

- (ii) *there exist $\mu < \lambda_1 = \frac{\pi^2}{(b-a)^2}$ and $R > 0$ such that for a.e. $t \in [a, b]$ and all $u \in \mathbb{R}$ with $|u| \geq R$,*

$$\frac{f(t, u)}{u} \geq -\mu.$$

Then the problem (3.1) has at least three nontrivial solutions u_i such that $u_1 < 0, u_2 > 0$ and u_3 changes sign.

PROOF. *Claim. There exists $\alpha_1 < 0$ which is a lower solution of (3.1).* Let $h \in L^1(a, b)$ be such that $h \geq 0$ and for a.e. $t \in [a, b]$ and all $u \leq 0$,

$$f(t, u) < -\mu u + h(t).$$

Define then α_1 to be the solution of

$$u'' = -\mu u + h(t), \quad u(a) = 0, \quad u(b) = 0.$$

As $\mu < \lambda_1$ and $h \geq 0$ we have $\alpha_1 < 0$ and

$$\alpha_1''(t) = -\mu \alpha_1(t) + h(t) > f(t, \alpha_1(t)), \quad \alpha_1(a) = 0, \quad \alpha_1(b) = 0,$$

i.e., α_1 is a lower solution.

Claim. There exists $\beta_2 > 0$ which is an upper solution of (3.1). We construct β_2 as we did for α_1 .

The modified problem. Consider the modified problem

$$u'' = \bar{f}(t, u), \quad u(a) = 0, \quad u(b) = 0, \tag{3.19}$$

where

$$\bar{f}(t, u) = \begin{cases} f(t, \alpha_1(t)), & \text{if } u < \alpha_1(t), \\ f(t, u), & \text{if } \alpha_1(t) \leq u \leq \beta_2(t), \\ f(t, \beta_2(t)), & \text{if } u > \beta_2(t), \end{cases}$$

and the corresponding functional

$$\bar{\phi}(u) = \int_a^b \left[\frac{u'^2(t)}{2} + \bar{F}(t, u(t)) \right] dt,$$

with $\bar{F}(t, u) = \int_0^u \bar{f}(t, s) ds$. As usual, it is easy to see that every solution of (3.19) satisfies $\alpha_1 \leq u \leq \beta_2$ and is a solution of (3.1).

Existence of the solutions u_1 and u_2 . Define $\varphi_1(t) = \sin(\pi \frac{t-a}{b-a})$ and let us fix $\epsilon > 0$ small enough so that $\epsilon < \min\{\delta/4, \lambda - \lambda_2\}$, $-4\epsilon\varphi_1 > \alpha_1$ and $4\epsilon\varphi_1 < \beta_2$. It is easy to see that $\beta_1 = -\epsilon\varphi_1$ and $\alpha_2 = \epsilon\varphi_1$ are respectively upper and lower solutions of (3.1) but are not solutions. This follows from

$$\begin{aligned} \beta_1''(t) &= \epsilon\lambda_1\varphi_1(t) < f(t, -\epsilon\varphi_1(t)) = f(t, \beta_1(t)), \\ \alpha_2''(t) &= -\epsilon\lambda_1\varphi_1(t) > f(t, \epsilon\varphi_1(t)) = f(t, \alpha_2(t)). \end{aligned}$$

Using Assumption (H) and Proposition 2.12, they are strict upper and lower solutions. Theorem 3.1 applies then with $\alpha = \alpha_i$ and $\beta = \beta_i$, which implies the existence of solutions $u_1 \in C^{\beta_1}$ and $u_2 \in C_{\alpha_2}$.

Existence of a third nontrivial solution. Observe that as $\bar{\phi}$ is coercive, it satisfies the Palais–Smale condition. Hence we can apply Theorem 3.9 with $\alpha = \alpha_2$ and $\beta = \beta_1$. This proves the existence of a solution $u_3 \in C_0^1([a, b]) \setminus (C^{\beta_1} \cup C_{\alpha_2})$, i.e. $u_3 \neq u_1$ and $u_3 \neq u_2$. The main problem is to prove that u_3 is not the trivial solution. To this aim, we prove that $c = \bar{\phi}(u_3) < 0 = \bar{\phi}(0)$.

Define $\gamma \in \Gamma$ (with $\alpha = \alpha_2, \beta = \beta_1$) in the following way

$$\gamma(s) = \begin{cases} 2\epsilon((2s-1)\varphi_1 + 2s\varphi_2), & \text{if } s \in [0, \frac{1}{2}], \\ 2\epsilon((2s-1)\varphi_1 + 2(1-s)\varphi_2), & \text{if } s \in [\frac{1}{2}, 1], \end{cases}$$

where $\varphi_2(t) = \sin(2\pi \frac{t-a}{b-a})$. Observe that

$$\begin{aligned} \gamma(0) &= -2\epsilon\varphi_1 < \beta_1, & \gamma(1) &= 2\epsilon\varphi_1 > \alpha_2, \\ \alpha_1 &< -4\epsilon\varphi_1 \leq \gamma(s) \leq 4\epsilon\varphi_1 < \beta_2 & \text{for all } s \in [0, 1]. \end{aligned}$$

Moreover, for $s \in [0, \frac{1}{2}]$,

$$\bar{\phi}(\gamma(s)) = \int_a^b [2\epsilon^2((2s-1)^2(\varphi_1')^2(t) + 4s^2(\varphi_2')^2(t))$$

$$\begin{aligned}
 & + \bar{F}(t, 2\epsilon((2s - 1)\varphi_1(t) + 2s\varphi_2(t))) \, dt \\
 & \leq \int_a^b [2\epsilon^2((2s - 1)^2\lambda_1\varphi_1^2(t) + 4s^2\lambda_2\varphi_2^2(t)) \\
 & \quad - \lambda 2\epsilon^2((2s - 1)\varphi_1(t) + 2s\varphi_2(t))^2] \, dt \\
 & \leq \epsilon^2(b - a)[(2s - 1)^2(\lambda_1 - \lambda) + 4s^2(\lambda_2 - \lambda)] \\
 & \leq \epsilon^2(b - a)[(2s - 1)^2 + 4s^2](\lambda_2 - \lambda) \\
 & \leq -\frac{\epsilon^3}{2}(b - a).
 \end{aligned}$$

In the same way, we compute for $s \in [\frac{1}{2}, 1]$,

$$\bar{\phi}(\gamma(s)) \leq -\frac{\epsilon^3}{2}(b - a).$$

Hence $c \leq -\frac{\epsilon^3}{2}(b - a) < 0$. This implies the third solution u_3 is nontrivial.

Claim. The function u_3 changes sign. Assume $u_3 \geq 0$ and define $\eta = \max\{\tau \geq 0 \mid u_3 - \tau\varphi_1 \geq 0\}$. Observe first that

$$\begin{aligned}
 u_3'' - m(t)u_3 &= f(tu_3) - m(t)u_3 \leq f(t, 0) = 0, \\
 u_3(a) &= 0, \quad u_3(b) = 0.
 \end{aligned}$$

As $u_3 \neq 0$, we deduce from the maximum principle that $u_3 > 0$ which implies that $\eta > 0$. Let us assume now that $\eta < \delta$. We can find then $t_0 \in [a, b]$ such that $u_3(t_0) - \eta\varphi_1(t_0) = 0$, $u_3'(t_0) - \eta\varphi_1'(t_0) = 0$ and for t close enough to t_0

$$\begin{aligned}
 (t - t_0)(u_3 - \eta\varphi_1)'(t) &= (t - t_0) \int_{t_0}^t (f(s, u_3(s)) + \lambda_1\eta\varphi_1(s)) \, ds \\
 &\leq -(\lambda - \lambda_1)(t - t_0)\eta \int_{t_0}^t \varphi_1(s) \, ds < 0.
 \end{aligned}$$

This contradicts the minimality of $u_3 - \eta\varphi_1$ for $t = t_0$. It follows that $u_3 \geq \delta\varphi_1 > \alpha_2$ which contradicts the localization of u_3 .

We prove in a similar way that u_3 cannot be negative. Therefore u_3 changes sign. □

A five solutions theorem

An additional solution can be obtained by combining variational methods and degree theory. Here we impose that the slope $-\frac{f(t,u)}{u}$ lies between two consecutive eigenvalues for small values of u .

THEOREM 3.11. *Assume that $f \in C^1([a, b] \times \mathbb{R})$ satisfies assumption (H) together with*

(i) there exist $p, q, k \geq 2$ ($k \in \mathbb{N}$) and $\delta > 0$ such that for a.e. $t \in [a, b]$ and all $u \in [-\delta, \delta]$,

$$\lambda_k := \frac{k^2\pi^2}{(b-a)^2} < p \leq -\frac{f(t, u)}{u} \leq q < \frac{(k+1)^2\pi^2}{(b-a)^2} =: \lambda_{k+1};$$

(ii) there exist $\mu < \lambda_1 = \frac{\pi^2}{(b-a)^2}$ and $R > 0$ such that for a.e. $t \in [a, b]$ and all $u \in \mathbb{R}$ with $|u| \geq R$,

$$\frac{f(t, u)}{u} \geq -\mu.$$

Then the problem (3.1) has at least four nontrivial solutions u_i such that $u_1 < 0, u_2 > 0$ and u_3, u_4 change sign.

PROOF. As in the proof of Theorem 3.10, we choose strict lower solutions α_i and strict upper solutions β_i such that

$$\alpha_1 < -\delta\varphi_1 < \beta_1 = -\varepsilon\varphi_1 \quad \text{and} \quad \alpha_2 = \varepsilon\varphi_1 < \delta\varphi_1 < \beta_2,$$

where $\varepsilon \in]0, \delta[$. As in Theorem 1.3, we can prove the problem (3.1) has two solutions $u_1 < \beta_1$ and $u_2 > \alpha_2$ such that u_1 is the maximum solution in $[\alpha_1, \beta_1]$ and u_2 is the minimum solution in $[\alpha_2, \beta_2]$. Moreover we can prove as in the proof of Theorem 3.10 that

$$u_1 < -\delta\varphi_1 \quad \text{and} \quad u_2 > \delta\varphi_1.$$

Consider now the modified problem

$$u'' = \bar{f}(t, u), \quad u(a) = 0, \quad u(b) = 0, \tag{3.20}$$

where

$$\bar{f}(t, u) = \begin{cases} f(t, u_1(t)), & \text{if } u < u_1(t), \\ f(t, u), & \text{if } u_1(t) \leq u < u_2(t), \\ f(t, u_2(t)), & \text{if } u_2(t) \leq u, \end{cases}$$

and the corresponding functional

$$\bar{\phi}(u) = \int_a^b \left[\frac{u'^2}{2} + \bar{F}(t, u(t)) \right] dt,$$

with $\bar{F}(t, u(t)) = \int_0^u \bar{f}(t, s) ds$. As usual, it is easy to see that every solution of (3.20) satisfies $u_1 \leq u \leq u_2$ and is a solution of (3.1). As in the proof of Theorem 3.10, we see

that the problem (3.20) and hence (3.1) has a third solution $u_3 \neq 0$, which changes sign and is such that

$$\bar{\phi}(u_3) = \inf_{\gamma \in \Gamma} \max_{s \in T_\gamma} \bar{\phi}(\gamma(s)) < 0,$$

where Γ and T_γ are defined in (3.17) with ϕ replaced by $\bar{\phi}$. Assume by contradiction that the only solutions of (3.20) are u_1, u_2, u_3 and 0. As $u_1 - 1$ is a strict lower solution of (3.20) and u_1 is the only solution in $C_{u_1-1} \cap C^{\beta_1}$, by Theorem 3.1, u_1 minimizes $\bar{\phi}$ on a $C_0^1([a, b])$ -neighbourhood of this point. It is also a minimizer on some $H_0^1(a, b)$ -neighbourhood as follows from Theorem 8 in [38]. Similarly, u_2 is a local minimizer of $\bar{\phi}$ in $H_0^1(a, b)$. By [7], there exists $r > 0$ such that

$$\deg(I - KN, B(u_1, r)) = 1 \quad \text{and} \quad \deg(I - KN, B(u_2, r)) = 1,$$

where K, N are defined from (3.12) with f replaced by \bar{f} and $m = 0$.

Suppose $\bar{\phi}(u_1) \geq \bar{\phi}(u_2)$; a similar argument holds if $\bar{\phi}(u_2) > \bar{\phi}(u_1)$. We can prove (see [37]) that there exists $\gamma > 0$ such that

$$\inf\{\bar{\phi}(u) \mid \|u - u_1\|_{H_0^1} = \gamma\} > \bar{\phi}(u_1).$$

Hence, by the Mountain Pass theorem [57], u_3 is of mountain pass type and there exists $r > 0$ such that

$$\deg(I - KN, B(u_3, r)) = -1.$$

Moreover, as $KN(H_0^1(a, b)) \subset B(0, R)$ for some $R > 0$,

$$\deg(I - KN, B(0, R)) = 1.$$

Let us prove next that for $r > 0$ small enough

$$|\deg(I - KN, B(0, r))| = 1.$$

Consider the homotopy

$$u'' = s \bar{f}(t, u) - (1 - s) \frac{p+q}{2} u, \quad u(a) = 0, \quad u(b) = 0. \tag{3.21}$$

Notice that for a.e. $t \in [a, b]$ and all $u \in [\max(-\delta, u_1(t)), \min(u_2(t), \delta)]$

$$\lambda_k < p \leq -s \frac{\bar{f}(t, u)}{u} + (1 - s) \frac{p+q}{2} \leq q < \lambda_{k+1}.$$

Hence, for every $\epsilon > 0$, we can find $r > 0$ small enough such that if $u \in \partial B(0, r)$ is a solution of (3.21), we have

$$-u'' = A(t)u, \quad u(a) = 0, \quad u(b) = 0,$$

with

$$A(t) := -s \frac{\tilde{f}(t, u)}{u} + (1 - s) \frac{p + q}{2} \in [p, q] \subset]\lambda_k, \lambda_{k+1}[\quad \text{for } t \in [a + \epsilon, b - \epsilon]$$

and $A(t) \in [0, q]$ for $t \in [a, b]$. By eigenvalue comparison, we conclude that $u \equiv 0$. Hence, using properties of the degree, we can write

$$\left| \deg(I - KN, B(0, r)) \right| = \left| \deg\left(I - K\left(\frac{p + q}{2} I\right), B(0, r) \right) \right| = 1.$$

We come to the contradiction

$$\begin{aligned} \deg(I - KN, B(0, R)) &= \deg(I - KN, B(u_1, r)) + \deg(I - KN, B(u_2, r)) \\ &\quad + \deg(I - KN, B(u_3, r)) + \deg(I - KN, B(0, r)) \\ &= 2 - 1 \pm 1 \neq 1. \end{aligned}$$

This proves existence of an additional nontrivial solution u_4 of (3.20). Recall that such a solution lies in $[u_1, u_2]$ and from the definition of u_1 and u_2 , $u_4 \notin C^{\beta_1} \cup C_{\alpha_2}$. Arguing as in Theorem 3.10, we prove then that this solution changes sign. \square

3.3. Historical and bibliographical notes

As we mentioned in the introduction, existence of a minimum of the related functional between a lower and an upper solution was noticed independently by Chang [17,18] and de Figueiredo and Solimini [38]. Theorems 3.1 and 3.2 provide such a result respectively for the Dirichlet and the periodic problem.

De Figueiredo and Solimini [38] noticed that under certain conditions, the minimum obtained between the lower and the upper solution is valid in the H_0^1 -topology. More recently Brezis and Nirenberg [13] pointed out the interest of this result and extended it to nonlinearities with critical growth.

Application to the existence of sequences of solutions as in Theorem 3.3 is due to Omari and Zanolin [76]. Proposition 3.4, which considers a prescribed mean curvature problem, is adapted from Habets and Omari [49].

The idea to combine invariant sets in C^1 with variational methods is worked out in Section 3.2. This gives a new point of view on the relation with variational methods. This goes back to Chang [17,18]. Developments of this idea can be found in [10,19,26,56,67, 68]. The study of the Dirichlet problem with nonordered lower and upper solutions as in Theorem 3.9 presents an alternative to the result of [24]. The Four Solutions theorem and the Five Solutions theorem (Theorems 3.10 and 3.11) are known results and can be found, with another proof, in [56].

4. Monotone methods

4.1. Abstract results

Let Z be a Banach space. An *order cone* $K \subset Z$ is a closed set such that

- for all u and $v \in K$, $u + v \in K$,
- for all $t \in \mathbb{R}^+$ and $u \in K$, $tu \in K$,
- if $u \in K$ and $-u \in K$ then $u = 0$.

Such a cone K induces an *order* on Z :

$$u \leq v \quad \text{if and only if} \quad v - u \in K.$$

We write equivalently $u \leq v$ or $v \geq u$. The cone is said to be *normal* if there exists $c > 0$ such that $0 \leq u \leq v$ implies $\|u\| \leq c\|v\|$.

The following theorem gives conditions for an increasing sequence $(\alpha_n)_n$ to converge to a fixed point of an operator T .

THEOREM 4.1. *Let $X \subset Z$ be continuously included Banach spaces so that Z has a normal order cone. Let α and $\beta \in X$, $\alpha \leq \beta$,*

$$\mathcal{E} = \{u \in X \mid \alpha \leq u \leq \beta\} \tag{4.1}$$

and let $T : \mathcal{E} \rightarrow X$ be completely continuous in X . Assume the sequence $(\alpha_n)_n$ defined by

$$\alpha_0 = \alpha, \quad \alpha_n = T\alpha_{n-1}, \tag{4.2}$$

is bounded in X and for all $n \in \mathbb{N}$

$$\alpha_n \leq \alpha_{n+1} \leq \beta.$$

Then the sequence $(\alpha_n)_n$ converges monotonically in X to a fixed point u of T such that

$$\alpha \leq u \leq \beta.$$

PROOF. *Claim. The sequence $(\alpha_n)_n$ converges in X . The sequence $(\alpha_n)_n$ is increasing and included in \mathcal{E} . As the set $A = \{\alpha_n \mid n \in \mathbb{N}\}$ is bounded in X , $T(A)$ is relatively compact in X . Hence, any sequence $(\alpha_{n_k})_k \subset (\alpha_n)_n$ has a converging subsequence in X and therefore in Z . As the order cone is normal and the sequence is monotone, the sequence itself converges in Z , i.e., there exists $u \in Z$ so that*

$$\alpha \leq u \leq \beta \quad \text{and} \quad \alpha_n \xrightarrow{Z} u.$$

It follows that all such subsequences converging in X have the same limit u , which implies

$$\alpha_n \xrightarrow{X} u.$$

Next, we deduce from the continuity of T that u is a fixed point of T . □

A similar result holds to prove the convergence of decreasing sequences $(\beta_n)_n$.

THEOREM 4.2. *Let $X \subset Z$ be continuously included Banach spaces so that Z has a normal order cone. Let α and $\beta \in X$, $\alpha \leq \beta$, \mathcal{E} be defined by (4.1) and $T : \mathcal{E} \rightarrow X$ be completely continuous in X . Assume the sequence $(\beta_n)_n$ defined by*

$$\beta_0 = \beta, \quad \beta_n = T\beta_{n-1}, \tag{4.3}$$

is bounded in X and for all $n \in \mathbb{N}$

$$\beta_n \geq \beta_{n+1} \geq \alpha.$$

Then the sequence $(\beta_n)_n$ converges monotonically in X to a fixed point v of T such that

$$\alpha \leq v \leq \beta.$$

As a corollary we can write the following result which deals with maps T that are monotone increasing, i.e., $u \leq v$ implies $Tu \leq Tv$.

THEOREM 4.3. *Let $X \subset Z$ be continuously included Banach spaces so that Z has a normal order cone. Let α and $\beta \in X$, $\alpha \leq \beta$, \mathcal{E} be defined by (4.1) and let $T : \mathcal{E} \rightarrow X$ be continuous and monotone increasing. Assume $T(\mathcal{E})$ is relatively compact in X and*

$$\alpha \leq T\alpha \quad \text{and} \quad T\beta \leq \beta.$$

Then, the sequence $(\alpha_n)_n$ and $(\beta_n)_n$ defined by (4.2) and (4.3) converge monotonically in X to fixed points u_{\min} and u_{\max} of T such that

$$\alpha \leq u_{\min} \leq u_{\max} \leq \beta.$$

Further, any fixed point $u \in \mathcal{E}$ of T verifies

$$u_{\min} \leq u \leq u_{\max}.$$

PROOF. *Claim 1.* *The sequence $(\alpha_n)_n$ converges in X to a fixed point u_{\min} of T such that $\alpha \leq u_{\min} \leq \beta$. As T is monotone increasing, we prove by induction that for any $n \in \mathbb{N}$, $\alpha_n \leq \alpha_{n+1} \leq \beta$. Hence, $(\alpha_n)_n \subset \mathcal{E}$ and since $T(\mathcal{E})$ is relatively compact in X the sequence $(\alpha_n)_n$ is bounded in X . The claim follows now from Theorem 4.1. Recall that T is completely continuous as $T(\mathcal{E})$ is relatively compact.*

Claim 2. The sequence $(\beta_n)_n$ converges in X to a fixed point u_{\max} of T such that $u_{\min} \leq u_{\max} \leq \beta$. Using Theorem 4.2 with $\alpha = u_{\min}$, we prove, as for Claim 1, existence of a fixed point u_{\max} such that $u_{\min} \leq u_{\max} \leq \beta$.

Claim 3. Any fixed point $u \in \mathcal{E}$ of T verifies $u_{\min} \leq u \leq u_{\max}$. Since $\alpha \leq u \leq \beta$, we deduce by induction $\alpha_n = T\alpha_{n-1} \leq Tu = u \leq T\beta_{n-1} = \beta_n$. The claim follows now by going to the limit. \square

4.2. Well-ordered lower and upper solutions

The periodic problem

Consider the periodic boundary value problem

$$u'' = f(t, u), \quad u(a) = u(b), \quad u'(a) = u'(b), \tag{4.4}$$

where f is a continuous function.

Our aim is to build an approximation scheme, easy to compute, that converges to solutions of (4.4). To this end, given continuous functions α and β , and $M > 0$, we consider the sequences $(\alpha_n)_n$ and $(\beta_n)_n$ defined by

$$\begin{aligned} \alpha_0 &= \alpha, \\ \alpha_n'' - M\alpha_n &= f(t, \alpha_{n-1}) - M\alpha_{n-1}, \\ \alpha_n(a) &= \alpha_n(b), \quad \alpha_n'(a) = \alpha_n'(b) \end{aligned} \tag{4.5}$$

and

$$\begin{aligned} \beta_0 &= \beta, \\ \beta_n'' - M\beta_n &= f(t, \beta_{n-1}) - M\beta_{n-1}, \\ \beta_n(a) &= \beta_n(b), \quad \beta_n'(a) = \beta_n'(b). \end{aligned} \tag{4.6}$$

The approximations α_n and β_n are “easy to compute”, in the sense that for every n , the problems (4.5) and (4.6) are linear and have unique solutions which read explicitly

$$\begin{aligned} \alpha_n(t) &= \int_a^b G(t, s)(f(s, \alpha_{n-1}(s)) - M\alpha_{n-1}(s)) \, ds, \\ \beta_n(t) &= \int_a^b G(t, s)(f(s, \beta_{n-1}(s)) - M\beta_{n-1}(s)) \, ds, \end{aligned}$$

where $G(t, s)$ is the Green’s function of the problem

$$\begin{aligned} u'' - Mu &= f(t), \\ u(a) &= u(b), \quad u'(a) = u'(b). \end{aligned} \tag{4.7}$$

Clearly this does not avoid numerical difficulties such as those related to stiff systems. This will be the case if we have to pick M very large.

The following theorem proves the convergence of the α_n and β_n .

THEOREM 4.4. *Let α and $\beta \in C^2([a, b])$, $\alpha \leq \beta$ and E be defined from (1.2). Assume $f : E \rightarrow \mathbb{R}$ is a continuous function, there exists $M > 0$ such that for all $(t, u_1), (t, u_2) \in E$,*

$$u_1 \leq u_2 \text{ implies } f(t, u_2) - f(t, u_1) \leq M(u_2 - u_1)$$

and for all $t \in [a, b]$

$$\begin{aligned} \alpha''(t) &\geq f(t, \alpha(t)), & \alpha(a) &= \alpha(b), & \alpha'(a) &\geq \alpha'(b), \\ \beta''(t) &\leq f(t, \beta(t)), & \beta(a) &= \beta(b), & \beta'(a) &\leq \beta'(b). \end{aligned}$$

Then the sequences $(\alpha_n)_n$ and $(\beta_n)_n$ defined by (4.5) and (4.6) converge monotonically in $C^1([a, b])$ to solutions u_{\min} and u_{\max} of (4.4) such that

$$\alpha \leq u_{\min} \leq u_{\max} \leq \beta.$$

Further, any solution u of (4.4) with graph in E verifies

$$u_{\min} \leq u \leq u_{\max}.$$

PROOF. Let $X = C^1([a, b])$, $Z = C([a, b])$, $K = \{u \in Z \mid u(t) \geq 0 \text{ on } [a, b]\}$ be the order cone in Z and \mathcal{E} be defined from (4.1). Define the operator $T : \mathcal{E} \rightarrow X$ by

$$Tu(t) = \int_a^b G(t, s)(f(s, u(s)) - Mu(s)) ds,$$

where $G(t, s)$ is the Green's function of (4.7). This operator is continuous in X and monotone increasing. Further, $T(\mathcal{E})$ is relatively compact in X , $\alpha \leq T\alpha$ and $\beta \geq T\beta$. The proof follows now from Theorem 4.3. □

REMARK. Notice that the assumption α and $\beta \in C^2([a, b])$ is not restrictive. If these functions are lower and upper solutions with angles, the first iterates α_1 and β_1 satisfy the assumptions of the theorem and are such that $\alpha \leq \alpha_1 \leq \beta_1 \leq \beta$.

Next, we consider a derivative dependent problem

$$u'' = f(t, u, u'), \quad u(a) = u(b), \quad u'(a) = u'(b). \tag{4.8}$$

As above, given $\alpha, \beta \in C^1([a, b])$ and $L > 0$, we consider the approximation schemes

$$\begin{aligned} \alpha_0 &= \alpha, \\ \alpha_n'' - L\alpha_n &= f(t, \alpha_{n-1}, \alpha'_{n-1}) - L\alpha_{n-1}, \\ \alpha_n(a) &= \alpha_n(b), \quad \alpha'_n(a) = \alpha'_n(b) \end{aligned} \tag{4.9}$$

and

$$\begin{aligned} \beta_0 &= \beta, \\ \beta_n'' - L\beta_n &= f(t, \beta_{n-1}, \beta'_{n-1}) - L\beta_{n-1}, \\ \beta_n(a) &= \beta_n(b), \quad \beta'_n(a) = \beta'_n(b). \end{aligned} \tag{4.10}$$

Such problems lead to a major difficulty. A straightforward application of the previous ideas would be to assume that for any u_1, u_2, v_1 and v_2 ,

$$u_1 \leq u_2 \quad \text{implies} \quad f(t, u_2, v_2) - f(t, u_1, v_1) \leq L(u_2 - u_1).$$

This would mean that f does not depend on derivatives.

The next theorem works out the difficulty. It is however weaker than Theorem 4.4 since it does not give maximal and minimal solutions. Its proof relies on the following maximum principle (see [6] or [85]).

PROPOSITION 4.5 (Maximum Principle). *Let $p, q \in L^1(a, b)$ be such that the first eigenvalue λ_1 of*

$$-u'' + pu' + qu + \lambda u = 0, \quad u(a) = u(b), \quad u'(a) = u'(b),$$

satisfies $\lambda_1 < 0$. Assume $u \in W^{2,1}(a, b)$ is a nontrivial function such that

$$-u'' + pu' + qu \geq 0, \quad u(a) = u(b), \quad u'(a) \leq u'(b).$$

Then $u > 0$ on $[a, b]$.

In general, we shall use the case where $p = 0$ and $q > 0$ are constants.

THEOREM 4.6. *Let α and $\beta \in C^2([a, b])$ and E be defined from (1.19). Assume $f : E \rightarrow \mathbb{R}$ is a continuous function, there exists $M \geq 0$ such that for all $(t, u_1, v), (t, u_2, v) \in E$,*

$$u_1 \leq u_2 \quad \text{implies} \quad f(t, u_2, v) - f(t, u_1, v) \leq M(u_2 - u_1), \tag{4.11}$$

there exists $N \geq 0$ such that for all $(t, u, v_1), (t, u, v_2) \in E$,

$$|f(t, u, v_2) - f(t, u, v_1)| \leq N|v_2 - v_1| \tag{4.12}$$

and for all $t \in [a, b]$

$$\begin{aligned} \alpha''(t) &\geq f(t, \alpha(t), \alpha'(t)), & \alpha(a) &= \alpha(b), \quad \alpha'(a) \geq \alpha'(b), \\ \beta''(t) &\leq f(t, \beta(t), \beta'(t)), & \beta(a) &= \beta(b), \quad \beta'(a) \leq \beta'(b). \end{aligned}$$

Finally, let $L > 0$ be such that

$$L \geq M + \frac{N^2}{2} + \frac{N}{2}\sqrt{N^2 + 4M} \tag{4.13}$$

and for all $t \in [a, b]$

$$f(t, \alpha(t), \alpha'(t)) - f(t, \beta(t), \beta'(t)) + L(\beta(t) - \alpha(t)) \geq 0.$$

Then, the sequences $(\alpha_n)_n$ and $(\beta_n)_n$ defined by (4.9) and (4.10) converge monotonically in $C^1([a, b])$ to solutions u and v of (4.8) such that

$$\alpha \leq u \leq v \leq \beta.$$

REMARKS. (a) The function $w = \beta - \alpha \geq 0$ satisfies

$$-w'' + N|w'| + (M + 1)w = h(t) \geq 0, \quad w(a) = w(b), \quad w'(b) \geq w'(a).$$

Hence, using the maximum principle we can prove that, if $\alpha \neq \beta$, our assumptions imply $\alpha < \beta$ on $[a, b]$. Also if u is a solution of (4.8) such that $\alpha \leq u \leq \beta$, we have $\alpha < u < \beta$.

(b) It is clear from Remark (a) that the assumptions on L are satisfied if L is large enough so that the theorem applies for any values of M and N which satisfy the assumptions (4.11) and (4.12).

(c) The conditions on L are immediately satisfied with $L = M$ if the function f does not depend on the derivative u' (i.e., $N = 0$).

(d) If α or β is a solution of (4.8), we have $\alpha_n = \alpha$ for all $n \in \mathbb{N}$ or $\beta_n = \beta$ for all $n \in \mathbb{N}$.

PROOF OF THEOREM 4.6. The proof uses Theorems 4.1 and 4.2 with $X = C^1([a, b])$, $Z = C([a, b])$ and $K = \{u \in Z \mid u(t) \geq 0 \text{ on } [a, b]\}$ as the order cone in Z . Let \mathcal{E} be defined from (4.1). The operator $T : \mathcal{E} \rightarrow X$, defined by

$$Tu(t) = \int_a^b G(t, s)(f(s, u(s), u'(s)) - Lu(s)) ds,$$

where $G(t, s)$ is the Green's function of (4.7) with $M = L$, is completely continuous in X . With these notations, the approximation schemes (4.9) and (4.10) are equivalent to (4.2) and (4.3).

A: Claim. Let $L > 0$ satisfy (4.13). Then the functions α_n defined recursively by (4.9) are such that for all $n \in \mathbb{N}$,

(a) α_n is a lower solution, i.e.,

$$\begin{aligned} \alpha_n''(t) &\geq f(t, \alpha_n(t), \alpha_n'(t)), \\ \alpha_n(a) &= \alpha_n(b), \quad \alpha_n'(a) \geq \alpha_n'(b), \end{aligned} \tag{4.14}$$

(b) $\alpha_{n+1} \geq \alpha_n$.

The proof is by induction.

Initial step: $n = 0$. The condition (4.14) for $n = 0$ is an assumption. Next, $w = \alpha_1 - \alpha_0$ is a solution of

$$\begin{aligned} -w'' + Lw &= \alpha_0''(t) - f(t, \alpha_0(t), \alpha_0'(t)) \geq 0, \\ w(a) &= w(b), \quad w'(a) \leq w'(b). \end{aligned}$$

Hence, we deduce (b) from the maximum principle.

Inductive step – 1st part: assume (a) and (b) hold for some n and let us prove that

$$\begin{aligned} \alpha_{n+1}''(t) &\geq f(t, \alpha_{n+1}(t), \alpha_{n+1}'(t)), \\ \alpha_{n+1}(a) &= \alpha_{n+1}(b), \quad \alpha_{n+1}'(a) \geq \alpha_{n+1}'(b). \end{aligned}$$

Let $w = \alpha_{n+1} - \alpha_n$. We have

$$\begin{aligned} -\alpha_{n+1}'' + f(t, \alpha_{n+1}, \alpha_{n+1}') & \\ = f(t, \alpha_{n+1}, \alpha_{n+1}') - f(t, \alpha_n, \alpha_n') - L(\alpha_{n+1} - \alpha_n) & \\ \leq M(\alpha_{n+1} - \alpha_n) + N|\alpha_{n+1}' - \alpha_n'| - L(\alpha_{n+1} - \alpha_n) & \\ = (M - L)w + N|w'|. & \end{aligned}$$

On the other hand, w satisfies

$$-w'' + Lw = h(t), \quad w(a) = w(b), \quad w'(b) - w'(a) = A, \tag{4.15}$$

with $h(t) := \alpha_n''(t) - f(t, \alpha_n(t), \alpha_n'(t)) \geq 0$ and $A \geq 0$. Its solution w reads

$$\begin{aligned} w(t) &= k \left[\int_a^t h(s) \cosh \sqrt{L} \left(\frac{b-a}{2} + s - t \right) ds \right. \\ &\quad \left. + \int_t^b h(s) \cosh \sqrt{L} \left(\frac{b-a}{2} + t - s \right) ds + A \cosh \sqrt{L} \left(t - \frac{a+b}{2} \right) \right] \end{aligned}$$

where

$$k = \left(2\sqrt{L} \sinh \sqrt{L} \frac{b-a}{2} \right)^{-1}.$$

Hence, to prove α_{n+1} is a lower solution, we only have to verify

$$\begin{aligned} \int_a^t \left[(M - L) \cosh \sqrt{L} \left(\frac{b-a}{2} + s - t \right) \right. \\ \left. + N\sqrt{L} \left| \sinh \sqrt{L} \left(\frac{b-a}{2} + s - t \right) \right| \right] h(s) ds \leq 0, \end{aligned}$$

$$\int_t^b \left[(M - L) \cosh \sqrt{L} \left(\frac{b-a}{2} + t - s \right) + N \sqrt{L} \left| \sinh \sqrt{L} \left(\frac{b-a}{2} + t - s \right) \right| \right] h(s) ds \leq 0,$$

and

$$(M - L) \cosh \sqrt{L} \left(t - \frac{a+b}{2} \right) + N \sqrt{L} \left| \sinh \sqrt{L} \left(t - \frac{a+b}{2} \right) \right| \leq 0.$$

Since h is non-positive and

$$(M - L) \cosh x + N \sqrt{L} |\sinh x| \leq (M - L + N \sqrt{L}) |\sinh x|$$

for all $x \in \mathbb{R}$, we obtain $(M - L)w + N|w'| \leq 0$ if $M - L + N\sqrt{L} \leq 0$, which follows from (4.13).

Inductive step – 2nd part: assume (a) and (b) hold for some n and let us prove that $\alpha_{n+2} \geq \alpha_{n+1}$. The function $w = \alpha_{n+2} - \alpha_{n+1}$ satisfies (4.15), where

$$h(t) := \alpha''_{n+1}(t) - f(t, \alpha_{n+1}(t), \alpha'_{n+1}(t)) \quad \text{and} \quad A = 0.$$

From the previous step $h(t) \geq 0$ and the claim follows from the maximum principle.

B: Claim. Let $L > 0$ satisfy (4.13). Then the functions β_n defined recursively by (4.10) are such that for all $n \in \mathbb{N}$,

(a) β_n is an upper solution, i.e.,

$$\begin{aligned} \beta''_n(t) &\leq f(t, \beta_n(t), \beta'_n(t)), \\ \beta_n(a) &= \beta_n(b), \quad \beta'_n(a) \leq \beta'_n(b), \end{aligned}$$

(b) $\beta_{n+1} \leq \beta_n$.

The proof of this claim parallels the proof of Claim A.

C: Claim. $\alpha_n \leq \beta_n$. Define, for all $i \in \mathbb{N}$, $w_i = \beta_i - \alpha_i$ and

$$h_i(t) := f(t, \alpha_i(t), \alpha'_i(t)) - f(t, \beta_i(t), \beta'_i(t)) + L(\beta_i(t) - \alpha_i(t)).$$

The proof of the claim is by induction.

Initial step: $\alpha_1 \leq \beta_1$. The function w_1 is a solution of (4.15) with $h = h_0 \geq 0$ and $A = 0$. Using the maximum principle, we deduce that $w_1 \geq 0$, i.e., $\alpha_1 \leq \beta_1$.

Inductive step: Let $n \geq 2$. If $h_{n-2} \geq 0$ and $\alpha_{n-1} \leq \beta_{n-1}$, then $h_{n-1} \geq 0$ and $\alpha_n \leq \beta_n$. First, let us prove that, for all $t \in [a, b]$, the function h_{n-1} is nonnegative. Indeed, we have

$$\begin{aligned} h_{n-1} &= f(\cdot, \alpha_{n-1}, \alpha'_{n-1}) - f(\cdot, \beta_{n-1}, \beta'_{n-1}) + L(\beta_{n-1} - \alpha_{n-1}) \\ &\geq -M(\beta_{n-1} - \alpha_{n-1}) - N|\beta'_{n-1} - \alpha'_{n-1}| + L(\beta_{n-1} - \alpha_{n-1}) \\ &= (L - M)w_{n-1} - N|w'_{n-1}|. \end{aligned}$$

Recall that w_{n-1} is a solution of (4.15) with $h(t) = h_{n-2}(t) \geq 0$ and $A = 0$. Hence, we can proceed as in the proof of Claim A to show that $h_{n-1} \geq 0$. It follows then from the maximum principle that w_n is nonnegative, i.e., $\alpha_n \leq \beta_n$.

D: *Claim.* There exists $R > 0$ such that any solution u of

$$u'' \leq f(t, u, u'), \quad u(a) = u(b), \quad u'(a) = u'(b),$$

with $\alpha \leq u \leq \beta$ satisfies $\|u'\|_\infty < R$. We deduce from the assumptions that

$$u'' = f(t, u, u') + h(t)$$

where $h(t) \leq 0$ and $f(t, u, u') + h(t) \leq \max_E |f(t, u, 0)| + N|u'|$. The proof follows now using Proposition 1.7.

E: *Claim.* There exists $R > 0$ such that any solution u of

$$u'' \geq f(t, u, u'), \quad u(a) = u(b), \quad u'(a) = u'(b),$$

with $\alpha \leq u \leq \beta$ satisfies $\|u'\|_\infty < R$. The proof repeats the argument of Claim D (See the remark that follows Proposition 1.7).

F: *Conclusion.* We deduce from Theorems 4.1 and 4.2 that the sequences $(\alpha_n)_n$ and $(\beta_n)_n$ converge monotonically in $C^1([a, b])$ to functions u and v which are solutions of (4.8) such that $\alpha \leq u \leq \beta$ and $\alpha \leq v \leq \beta$. Further, as $\alpha_n \leq \beta_n$ for any n , we have $u \leq v$. \square

REMARK. Notice that with a little additional work we can reduce problems to cases where Theorem 4.6 applies. For example, it does not apply to problem

$$\begin{aligned} u'' - u + (u')^2 &= \sin t, \\ u(0) &= u(2\pi), \quad u'(0) = u'(2\pi), \end{aligned}$$

as (4.12) is not satisfied. However, we can work it out as follows. Notice first that this problem satisfies a Nagumo condition. Next, we know that lower and upper solutions, α and $\beta \in [-1, 1]$, of problems that satisfy such a Nagumo condition have a priori bounded derivatives: $\|\alpha'\|_\infty$ and $\|\beta'\|_\infty \leq R$. We can modify then the equation for $|u'| \geq R$ so that the same Nagumo condition is satisfied for the modified problem together with (4.12). It follows then that the approximations defined from (4.9) and (4.10) satisfy the same bounds and that convergence of the approximations holds.

The Dirichlet problem

As in the periodic case, we can work with the Dirichlet problem

$$u'' = f(t, u), \quad u(a) = 0, \quad u(b) = 0, \tag{4.16}$$

where f is a continuous function.

The following result paraphrases Theorem 4.4.

THEOREM 4.7. *Let α and $\beta \in C^2([a, b])$, $\alpha \leq \beta$ and let E be defined from (1.2). Assume $f : E \rightarrow \mathbb{R}$ is a continuous function, there exists $M \geq 0$ such that for all $(t, u_1), (t, u_2) \in E$,*

$$u_1 \leq u_2 \quad \text{implies} \quad f(t, u_2) - f(t, u_1) \leq M(u_2 - u_1)$$

and for all $t \in [a, b]$

$$\begin{aligned} \alpha''(t) &\geq f(t, \alpha(t)), & \alpha(a) &\leq 0, \quad \alpha(b) \leq 0, \\ \beta''(t) &\leq f(t, \beta(t)), & \beta(a) &\geq 0, \quad \beta(b) \geq 0. \end{aligned}$$

Then the sequences $(\alpha_n)_n$ and $(\beta_n)_n$ defined by

$$\begin{aligned} \alpha_0 &= \alpha, \\ \alpha_n'' - M\alpha_n &= f(t, \alpha_{n-1}) - M\alpha_{n-1}, \\ \alpha_n(a) &= 0, \quad \alpha_n(b) = 0, \end{aligned}$$

and

$$\begin{aligned} \beta_0 &= \beta, \\ \beta_n'' - M\beta_n &= f(t, \beta_{n-1}) - M\beta_{n-1}, \\ \beta_n(a) &= 0, \quad \beta_n(b) = 0, \end{aligned}$$

converge uniformly and monotonically to solutions u_{\min} and u_{\max} of (4.16) such that

$$\alpha \leq u_{\min} \leq u_{\max} \leq \beta.$$

Further, any solution u of (4.16) with graph in E verifies

$$u_{\min} \leq u \leq u_{\max}.$$

PROOF. The proof of this theorem repeats the argument of Theorem 4.4. □

In case of derivative dependent equations

$$\begin{aligned} u'' &= f(t, u, u'), \\ u(a) &= 0, \quad u(b) = 0, \end{aligned} \tag{4.17}$$

approximation schemes similar to (4.9), (4.10) do not work. Here we have to work out a generalization as in the following theorem. Notice that we use lower and upper solutions that verify the boundary conditions.

THEOREM 4.8. *Let α and $\beta \in C^2([a, b])$, $\alpha \leq \beta$ and let E be defined from (1.19). Assume $f : E \rightarrow \mathbb{R}$ is a continuous function, there exists $M \geq 0$ such that for all $(t, u_1, v), (t, u_2, v) \in E$,*

$$u_1 \leq u_2 \quad \text{implies} \quad f(t, u_2, v) - f(t, u_1, v) \leq M(u_2 - u_1),$$

there exists $N \geq 0$ such that for all $(t, u, v_1), (t, u, v_2) \in E$,

$$|f(t, u, v_2) - f(t, u, v_1)| \leq N|v_2 - v_1|$$

and for all $t \in [a, b]$

$$\alpha''(t) \geq f(t, \alpha(t), \alpha'(t)), \quad \alpha(a) = 0, \quad \alpha(b) = 0,$$

$$\beta''(t) \leq f(t, \beta(t), \beta'(t)), \quad \beta(a) = 0, \quad \beta(b) = 0.$$

Finally, let $K_0 \in C([a, b])$ be such that $K_0(a) > 0$ and for all $t \in [a, b]$, $K_0(t) = -K_0(b + a - t)$. Then, for L large enough, the sequences $(\alpha_n)_n$ and $(\beta_n)_n$ defined by

$$\alpha''_{n+1} - \sqrt[3]{L} K_0(t) \alpha'_{n+1} - L \alpha_{n+1} = f(t, \alpha_n, \alpha'_n) - \sqrt[3]{L} K_0(t) \alpha'_n - L \alpha_n,$$

$$\alpha_{n+1}(a) = 0, \quad \alpha_{n+1}(b) = 0,$$

$$\beta''_{n+1} - \sqrt[3]{L} K_0(t) \beta'_{n+1} - L \beta_{n+1} = f(t, \beta_n, \beta'_n) - \sqrt[3]{L} K_0(t) \beta'_n - L \beta_n,$$

$$\beta_{n+1}(a) = 0, \quad \beta_{n+1}(b) = 0,$$

converge monotonically in $C^1([a, b])$ to solutions u and v of (4.17) such that, for all $t \in [a, b]$, we have

$$\alpha(t) \leq u(t) \leq v(t) \leq \beta(t).$$

PROOF. The above result can be proved adapting the proof of Theorem 4.6. □

4.3. Lower and upper solutions in reversed order

Consider the periodic boundary value problem

$$\begin{aligned} u'' &= f(t, u), \\ u(a) &= u(b), \quad u'(a) = u'(b), \end{aligned} \tag{4.18}$$

where f is a continuous function.

In Section 4.2, we have built an approximation scheme for solutions of (4.18) based on the maximum principle. Here, we consider a similar approach based on the antimaximum principle. Given continuous functions α and β , and $M > 0$, we consider the sequences $(\alpha_n)_n$ and $(\beta_n)_n$ defined by

$$\begin{aligned} \alpha_0 &= \alpha, \\ \alpha''_n + M \alpha_n &= f(t, \alpha_{n-1}) + M \alpha_{n-1}, \\ \alpha_n(a) &= \alpha_n(b), \quad \alpha'_n(a) = \alpha'_n(b) \end{aligned} \tag{4.19}$$

and

$$\begin{aligned} \beta_0 &= \beta, \\ \beta_n'' + M\beta_n &= f(t, \beta_{n-1}) + M\beta_{n-1}, \\ \beta_n(a) &= \beta_n(b), \quad \beta_n'(a) = \beta_n'(b). \end{aligned} \tag{4.20}$$

If M is not an eigenvalue of the periodic problem, i.e., $M \neq (\frac{2n\pi}{b-a})^2$ with $n \in \mathbb{N}$, the functions α_n and β_n , solutions of (4.19) and (4.20), can be written explicitly

$$\begin{aligned} \alpha_n(t) &= \int_a^b G(t, s)(f(s, \alpha_{n-1}(s)) + M\alpha_{n-1}(s)) ds, \\ \beta_n(t) &= \int_a^b G(t, s)(f(s, \beta_{n-1}(s)) + M\beta_{n-1}(s)) ds, \end{aligned}$$

where $G(t, s)$ is the Green's function of the problem

$$\begin{aligned} u'' + Mu &= f(t), \\ u(a) &= u(b), \quad u'(a) = u'(b). \end{aligned} \tag{4.21}$$

The next theorem indicates a framework to obtain convergence of the α_n and β_n to extremal solutions of (4.18). To prove this result we need the following antimaximum principle.

PROPOSITION 4.9 (Antimaximum Principle). *Let $q \in]0, \frac{\pi^2}{(b-a)^2}]$. Suppose $u \in \mathcal{C}^2([a, b])$ is a solution of*

$$u'' + qu = f(t), \quad u(a) - u(b) = 0, \quad u'(a) - u'(b) = A, \tag{4.22}$$

where $A \geq 0$ and $f \in \mathcal{C}([a, b])$, $f(t) \geq 0$. Then $u \geq 0$ on $[a, b]$.

PROOF. *Claim 1. If $f \not\equiv 0$, solutions u of (4.22) are one-signed.* Let t_0 be a zero of u . Extend u by periodicity, define $v(t) = \sin \sqrt{q}(t - t_0)$ and compute

$$\begin{aligned} u'(t_0) \sin \sqrt{q}(b - a) &\geq (u'v - v'u)|_{t_0}^b + (u'v - v'u)|_b^{t_0+b-a} \\ &= \int_{t_0}^{t_0+b-a} f(s) \sin \sqrt{q}(s - t_0) ds > 0. \end{aligned}$$

If $q = \frac{\pi^2}{(b-a)^2}$, this is contradictory. If $q \neq \frac{\pi^2}{(b-a)^2}$, this implies $u'(t_0) > 0$ and u cannot be a periodic function.

Claim 2. If $f \not\equiv 0$, any one-signed solution of (4.22) is positive. Direct integration of (4.22) gives

$$q \int_a^b u(s) ds = \int_a^b f(s) ds + A > 0.$$

Hence, we have $u(t) > 0$.

Claim 3. If $f(t) \equiv 0$, $u(t) \geq 0$. We deduce from a direct integration that

$$u(t) = A \frac{\cos \sqrt{q}(\frac{a+b}{2} - t)}{2\sqrt{q} \sin \sqrt{q}(\frac{b-a}{2})} \geq 0.$$

□

THEOREM 4.10. Let α and $\beta \in C^2([a, b])$, $\beta \leq \alpha$ and

$$E := \{(t, u) \in [a, b] \times \mathbb{R} \mid \beta(t) \leq u \leq \alpha(t)\}.$$

Assume $f : E \rightarrow \mathbb{R}$ is a continuous function, there exists $M \in]0, \frac{\pi^2}{(b-a)^2}]$ such that for all $(t, u_1), (t, u_2) \in E$,

$$u_1 \leq u_2 \quad \text{implies} \quad f(t, u_2) - f(t, u_1) \geq -M(u_2 - u_1)$$

and for all $t \in [a, b]$

$$\alpha''(t) \geq f(t, \alpha(t)), \quad \alpha(a) = \alpha(b), \quad \alpha'(a) \geq \alpha'(b),$$

$$\beta''(t) \leq f(t, \beta(t)), \quad \beta(a) = \beta(b), \quad \beta'(a) \leq \beta'(b).$$

Then the sequences $(\alpha_n)_n$ and $(\beta_n)_n$ defined by (4.19) and (4.20) converge monotonically in $C^1([a, b])$ to solutions u_{\max} and u_{\min} of (4.18) such that

$$\beta \leq u_{\min} \leq u_{\max} \leq \alpha.$$

Further, any solution u of (4.18) with graph in E verifies

$$u_{\min} \leq u \leq u_{\max}.$$

PROOF. Let $X = C^1([a, b])$, $Z = C([a, b])$, $K = \{u \in Z \mid u(t) \geq 0 \text{ on } [a, b]\}$ be the order cone in Z and

$$\mathcal{E} = \{u \in X \mid \beta \leq u \leq \alpha\}. \tag{4.23}$$

The operator $T : \mathcal{E} \rightarrow X$, defined by

$$Tu(t) = \int_a^b G(t, s)(f(s, u(s)) + Mu(s)) ds,$$

where $G(t, s)$ is the Green's function of (4.21), is continuous in X and monotone increasing (see Proposition 4.9). Further, $T(\mathcal{E})$ is relatively compact in X , $\beta \leq T\beta$ and $\alpha \geq T\alpha$. The proof follows now from Theorem 4.3, where α and β have to be interchanged. \square

Next, we consider the derivative dependent problem

$$\begin{aligned} u'' &= f(t, u, u'), \\ u(a) &= u(b), \quad u'(a) = u'(b). \end{aligned} \tag{4.24}$$

As above, given $\alpha, \beta \in C^1([a, b])$ and $L > 0$, we consider the approximation schemes

$$\begin{aligned} \alpha_0 &= \alpha, \\ \alpha_n'' + L\alpha_n &= f(t, \alpha_{n-1}, \alpha_{n-1}') + L\alpha_{n-1}, \\ \alpha_n(a) &= \alpha_n(b), \quad \alpha_n'(a) = \alpha_n'(b) \end{aligned} \tag{4.25}$$

and

$$\begin{aligned} \beta_0 &= \beta, \\ \beta_n'' + L\beta_n &= f(t, \beta_{n-1}, \beta_{n-1}') + L\beta_{n-1}, \\ \beta_n(a) &= \beta_n(b), \quad \beta_n'(a) = \beta_n'(b). \end{aligned} \tag{4.26}$$

The following result is a counterpart of Theorem 4.6.

THEOREM 4.11. *Let α and $\beta \in C^2([a, b])$, $\beta \leq \alpha$ and*

$$E := \{(t, u, v) \in [a, b] \times \mathbb{R}^2 \mid \beta(t) \leq u \leq \alpha(t)\}.$$

Assume $f : E \rightarrow \mathbb{R}$ is a continuous function, there exists $M \in]0, \frac{\pi^2}{(b-a)^2}[$ such that for all $(t, u_1, v), (t, u_2, v) \in E$,

$$u_1 \leq u_2 \quad \text{implies} \quad f(t, u_2, v) - f(t, u_1, v) \geq -M(u_2 - u_1),$$

there exists $N \geq 0$ such that for all $(t, u, v_1), (t, u, v_2) \in E$,

$$|f(t, u, v_2) - f(t, u, v_1)| \leq N|v_2 - v_1|$$

and for all $t \in [a, b]$

$$\begin{aligned} \alpha''(t) &\geq f(t, \alpha(t), \alpha'(t)), & \alpha(a) &= \alpha(b), & \alpha'(a) &\geq \alpha'(b), \\ \beta''(t) &\leq f(t, \beta(t), \beta'(t)), & \beta(a) &= \beta(b), & \beta'(a) &\leq \beta'(b). \end{aligned}$$

Finally, let $L \in]M, \frac{\pi^2}{(b-a)^2}[$ be such that

$$(L - M) \cos \sqrt{L} \left(\frac{b-a}{2} \right) - N \sqrt{L} \sin \sqrt{L} \left(\frac{b-a}{2} \right) \geq 0 \tag{4.27}$$

and

$$f(t, \alpha(t), \alpha'(t)) - f(t, \beta(t), \beta'(t)) + L(\alpha(t) - \beta(t)) \geq 0.$$

Then, the sequences $(\alpha_n)_n$ and $(\beta_n)_n$ defined by (4.25) and (4.26) converge monotonically in $C^1([a, b])$ to solutions u and v of (4.24) such that

$$\beta \leq v \leq u \leq \alpha.$$

PROOF. The proof uses Theorems 4.1 and 4.2 with $X = C^1([a, b])$, $Z = C([a, b])$ and $K = \{u \in Z \mid u(t) \geq 0 \text{ on } [a, b]\}$ as the order cone in Z . Let \mathcal{E} be defined from (4.23). The operator $T : \mathcal{E} \rightarrow X$, defined by

$$Tu(t) = \int_a^b G(t, s) (f(s, u(s), u'(s)) + Lu(s)) ds,$$

where $G(t, s)$ is the Green's function of (4.21) with M replaced by L , is completely continuous in X . With these notations, the approximation schemes (4.25) and (4.26) are equivalent to (4.3) and (4.2).

A: Claim. Let $L > 0$ satisfy (4.27). Then the functions α_n defined recursively by (4.25) are such that for all $n \in \mathbb{N}$,

(a) α_n is a lower solution, i.e.,

$$\begin{aligned} \alpha_n''(t) &\geq f(t, \alpha_n(t), \alpha_n'(t)), \\ \alpha_n(a) &= \alpha_n(b), \alpha_n'(a) \geq \alpha_n'(b), \end{aligned} \tag{4.28}$$

(b) $\alpha_{n+1} \leq \alpha_n$.

The proof is by induction.

Initial step: $n = 0$. The condition (4.28) for $n = 0$ is an assumption. Next, $w = \alpha_0 - \alpha_1$ is a solution of

$$\begin{aligned} w'' + Lw &= \alpha_0''(t) - f(t, \alpha_0(t), \alpha_0'(t)) \geq 0, \\ w(a) &= w(b), w'(a) \geq w'(b). \end{aligned}$$

Hence, we deduce (b) from the antimaximum principle (Proposition 4.9).

Inductive step – 1st part: assume (a) and (b) hold for some n and let us prove that

$$\begin{aligned} \alpha_{n+1}''(t) &\geq f(t, \alpha_{n+1}(t), \alpha_{n+1}'(t)), \\ \alpha_{n+1}(a) &= \alpha_{n+1}(b), \alpha_{n+1}'(a) \geq \alpha_{n+1}'(b). \end{aligned}$$

Let $w = \alpha_n - \alpha_{n+1} \geq 0$. We have

$$\begin{aligned} & -\alpha''_{n+1} + f(t, \alpha_{n+1}, \alpha'_{n+1}) \\ &= -f(t, \alpha_n, \alpha'_n) + f(t, \alpha_{n+1}, \alpha'_{n+1}) - L(\alpha_n - \alpha_{n+1}) \\ &\leq M(\alpha_n - \alpha_{n+1}) + N|\alpha'_{n+1} - \alpha'_n| - L(\alpha_n - \alpha_{n+1}) \\ &= (M - L)w + N|w'|. \end{aligned}$$

On the other hand, w satisfies

$$w'' + Lw = h(t), \quad w(a) = w(b), \quad w'(a) - w'(b) = C, \quad (4.29)$$

with $h(t) := \alpha''_n(t) - f(t, \alpha_n(t), \alpha'_n(t)) \geq 0$ and $C \geq 0$. Observe that

$$\begin{aligned} w(t) &= \frac{1}{2\sqrt{L} \sin \sqrt{L} \left(\frac{b-a}{2}\right)} \left[C \cos \sqrt{L} \left(\frac{a+b}{2} - t\right) \right. \\ &\quad + \int_a^t h(s) \cos \sqrt{L} \left(\frac{b-a}{2} + s - t\right) ds \\ &\quad \left. + \int_t^b h(s) \cos \sqrt{L} \left(\frac{b-a}{2} + t - s\right) ds \right]. \end{aligned}$$

Hence, using (4.27) and denoting $D = 2\sqrt{L} \sin \sqrt{L} \left(\frac{b-a}{2}\right)$, we compute

$$\begin{aligned} & (M - L)w(t) + N|w'(t)| \\ &\leq \frac{1}{D} \left[C \left[(M - L) \cos \sqrt{L} \left(\frac{a+b}{2} - t\right) + N\sqrt{L} \left| \sin \sqrt{L} \left(\frac{a+b}{2} - t\right) \right| \right] \right. \\ &\quad + \int_a^t h(s) \left[(M - L) \cos \sqrt{L} \left(\frac{b-a}{2} + s - t\right) \right. \\ &\quad \quad \left. \left. + N\sqrt{L} \left| \sin \sqrt{L} \left(\frac{b-a}{2} + s - t\right) \right| \right] ds \\ &\quad + \int_t^b h(s) \left[(M - L) \cos \sqrt{L} \left(\frac{b-a}{2} + t - s\right) \right. \\ &\quad \quad \left. \left. + N\sqrt{L} \left| \sin \sqrt{L} \left(\frac{b-a}{2} + t - s\right) \right| \right] ds \right] \\ &\leq 0. \end{aligned}$$

Hence α_{n+1} is a lower solution.

Inductive step – 2nd part: assume (a) and (b) hold for some n and let us prove that $\alpha_{n+2} \leq \alpha_{n+1}$. The function $w = \alpha_{n+1} - \alpha_{n+2}$ satisfies (4.29), where

$$h(t) := \alpha''_{n+1}(t) - f(t, \alpha_{n+1}(t), \alpha'_{n+1}(t)) \quad \text{and} \quad C = 0.$$

From the previous step $h(t) \geq 0$ and the claim follows from the antimaximum principle (Proposition 4.9).

B: Claim. Let $L > 0$ satisfy (4.27). Then the functions β_n defined recursively by (4.26) are such that for all $n \in \mathbb{N}$,

(a) β_n is an upper solution, i.e.,

$$\begin{aligned} \beta''_n(t) &\leq f(t, \beta_n(t), \beta'_n(t)), \\ \beta_n(a) &= \beta_n(b), \quad \beta'_n(a) \leq \beta'_n(b), \end{aligned}$$

(b) $\beta_{n+1} \geq \beta_n$.

The proof of this claim parallels the proof of Claim A.

C: Claim. $\alpha_n \geq \beta_n$. Define, for all $i \in \mathbb{N}$, $w_i = \alpha_i - \beta_i$ and

$$h_i(t) := f(t, \alpha_i(t), \alpha'_i(t)) - f(t, \beta_i(t), \beta'_i(t)) + L(\alpha_i(t) - \beta_i(t)).$$

The proof of the claim is by induction.

Initial step: $\alpha_1 \geq \beta_1$. The function w_1 is a solution of (4.29) with $h = h_0 \geq 0$ and $C = 0$. Using the antimaximum principle (Proposition 4.9), we deduce that $w_1 \geq 0$, i.e., $\alpha_1 \geq \beta_1$.

Inductive step: Let $n \geq 2$. If $h_{n-2} \geq 0$ and $\alpha_{n-1} \geq \beta_{n-1}$, then $h_{n-1} \geq 0$ and $\alpha_n \geq \beta_n$. First, let us prove that, for all $t \in [a, b]$, the function h_{n-1} is nonnegative. Indeed, we have

$$\begin{aligned} h_{n-1} &= f(\cdot, \alpha_{n-1}, \alpha'_{n-1}) - f(\cdot, \beta_{n-1}, \beta'_{n-1}) + L(\alpha_{n-1} - \beta_{n-1}) \\ &\geq -M(\alpha_{n-1} - \beta_{n-1}) - N|\alpha'_{n-1} - \beta'_{n-1}| + L(\alpha_{n-1} - \beta_{n-1}) \\ &= (L - M)w_{n-1} - N|w'_{n-1}|. \end{aligned}$$

Recall that w_{n-1} is a solution of (4.29) with $h(t) = h_{n-2}(t) \geq 0$ and $C = 0$. Hence, we can proceed as in the proof of Claim A to show that $h_{n-1} \geq 0$. It follows then from the antimaximum principle (Proposition 4.9) that w_n is nonnegative, i.e., $\alpha_n \leq \beta_n$.

D: Claim. There exists $R > 0$ such that any solution u of

$$u'' \leq f(t, u, u'), \quad u(a) = u(b), \quad u'(a) = u'(b),$$

with $\beta \leq u \leq \alpha$ satisfies $\|u'\|_\infty < R$. We deduce from the assumptions that

$$u'' = f(t, u, u') + h(t),$$

where $h(t) \leq 0$ and $f(t, u, u') + h(t) \leq \max_E |f(t, u, 0)| + N|u'|$. The proof follows now using Proposition 1.7.

E: *Claim.* There exists $R > 0$ such that any solution u of

$$u'' \geq f(t, u, u'), \quad u(a) = u(b), \quad u'(a) = u'(b),$$

with $\beta \leq u \leq \alpha$ satisfies $\|u'\|_\infty < R$. The proof repeats the argument of Claim D but uses the remark following Proposition 1.7.

F: *Conclusion.* We deduce from Theorems 4.2 and 4.1, where α and β have to be interchanged, that the sequences $(\alpha_n)_n$ and $(\beta_n)_n$ converge monotonically in $C^1([a, b])$ to functions u and v such that $\beta \leq v \leq \alpha$ and $\beta \leq u \leq \alpha$. Further Claim C implies $v \leq u$. \square

4.4. A mixed approximation scheme

In this section, we consider a derivative independent Dirichlet problem

$$u'' = f(t, u, u), \quad u(a) = 0, \quad u(b) = 0. \tag{4.30}$$

Here we write the nonlinearity so that $f(t, u, v)$ is nonincreasing in u and nondecreasing in v . We work out an approximation scheme which provides only bounds on the solutions. However, we shall give assumptions which imply these bounds to be equal, so that they are solutions.

Let us introduce the following definition.

DEFINITION 4.1. Functions α and $\beta \in C([a, b])$ are *coupled lower and upper quasi-solutions* of (4.30) if

- (a) for any $t \in [a, b]$, $\alpha(t) \leq \beta(t)$;
- (b) for any $t_0 \in]a, b[$, either $D_- \alpha(t_0) < D^+ \alpha(t_0)$ or there exists an open interval $I_0 \subset]a, b[$ such that $t_0 \in I_0$, $\alpha \in W^{2,1}(I_0)$, and for a.e. $t \in I_0$

$$\alpha''(t) \geq f(t, \alpha(t), \beta(t));$$

- (c) for any $t_0 \in]a, b[$, either $D^- \beta(t_0) > D_+ \beta(t_0)$ or there exists an open interval $I_0 \subset]a, b[$ such that $t_0 \in I_0$, $\beta \in W^{2,1}(I_0)$, and for a.e. $t \in I_0$

$$\beta''(t) \leq f(t, \beta(t), \alpha(t));$$

- (d) $\alpha(a) \leq 0 \leq \beta(a), \alpha(b) \leq 0 \leq \beta(b)$.

Consider the following auxiliary problem

$$\begin{aligned} u'' &= f(t, u, v), & u(a) &= 0, & u(b) &= 0, \\ v'' &= f(t, v, u), & v(a) &= 0, & v(b) &= 0. \end{aligned} \tag{4.31}$$

PROPOSITION 4.12. Let $\alpha_0, \beta_0 \in C([a, b])$,

$$E := \{(t, u, v) \mid t \in [a, b], u, v \in [\alpha_0(t), \beta_0(t)]\}$$

and $f : E \rightarrow \mathbb{R}$ be an L^1 -Carathéodory function such that $f(t, u, v)$ is nonincreasing in u and nondecreasing in v . Assume α_0 and β_0 are coupled lower and upper quasi-solutions of (4.30). Then, the sequences $(\alpha_n)_n$ and $(\beta_n)_n$, defined for $n \geq 1$ by

$$\begin{aligned} \alpha_n'' &= f(t, \alpha_{n-1}, \beta_{n-1}), & \alpha_n(a) &= 0, & \alpha_n(b) &= 0, \\ \beta_n'' &= f(t, \beta_{n-1}, \alpha_{n-1}), & \beta_n(a) &= 0, & \beta_n(b) &= 0, \end{aligned}$$

converge in $C^1([a, b])$ to functions u_{\min} and u_{\max} . The pair (u_{\min}, u_{\max}) is a solution of (4.31) such that

$$\alpha_0 \leq u_{\min} \leq u_{\max} \leq \beta_0.$$

Moreover, any solution (u, v) of (4.31) with $\alpha_0 \leq u \leq \beta_0, \alpha_0 \leq v \leq \beta_0$ is such that

$$u_{\min} \leq u \leq u_{\max}, \quad u_{\min} \leq v \leq u_{\max}.$$

PROOF. Let $X = C^1([a, b]) \times C^1([a, b])$, $Z = C([a, b]) \times C([a, b])$, $K = \{(u, v) \in Z \mid u \geq 0, v \leq 0\}$ and $\mathcal{E} = \{(u, v) \in X \mid \alpha_0 \leq u \leq \beta_0, \alpha_0 \leq v \leq \beta_0\}$. We define $T : \mathcal{E} \rightarrow X$, $(u, v) \mapsto T(u, v)$, where $T(u, v)$ is the solution (x, y) of

$$\begin{aligned} x'' &= f(t, u, v), & x(a) &= 0, & x(b) &= 0, \\ y'' &= f(t, v, u), & y(a) &= 0, & y(b) &= 0. \end{aligned}$$

Next, we verify that T is continuous, monotone increasing, $T(\mathcal{E})$ is relatively compact in X and

$$(\alpha, \beta) \leq T(\alpha, \beta), \quad (\beta, \alpha) \geq T(\beta, \alpha).$$

Now, Theorem 4.3 applies with $\alpha = (\alpha_0, \beta_0)$ and $\beta = (\beta_0, \alpha_0)$, and the claims follow. \square

Notice that if u is a solution of the given problem (4.30), then (u, u) is a solution of the auxiliary problem (4.31), whence u_{\min} and u_{\max} are bounds on solutions of (4.30). The following proposition proves, under appropriate assumptions, convergence of the sequences defined in Proposition 4.12 to the unique solution of the given problem (4.30).

THEOREM 4.13. Suppose the assumptions of Proposition 4.12 hold. Assume moreover

- (i) there exists $\epsilon > 0$ such that $\alpha_0 \geq \epsilon\beta_0$;
- (ii) for every $s \in [\epsilon, 1[$, almost every $t \in [a, b]$ and every $u, v \in [\alpha_0, \beta_0]$ with $sv \leq u \leq v$,

$$sf\left(t, \frac{u}{s}, sv\right) > f(t, u, v).$$

Then, the functions u_{\min} and u_{\max} defined in Proposition 4.12 are equal, i.e., are solutions of (4.30).

PROOF. From assumption (i), we deduce

$$\epsilon u_{\max} \leq u_{\min} \leq u_{\max}.$$

Let $s_0 = \sup\{s \mid s u_{\max} \leq u_{\min}\}$. It is obvious that $s_0 \in [\epsilon, 1]$ and that $s_0 u_{\max} \leq u_{\min}$. From the definition of s_0 , we deduce the existence of $t_0 \in [a, b]$ such that

$$u_{\min}(t_0) - s_0 u_{\max}(t_0) = 0, \quad u'_{\min}(t_0) - s_0 u'_{\max}(t_0) = 0.$$

If $t_0 \neq b$, we also have $t_1 > t_0$ such that $u'_{\min}(t_1) - s_0 u'_{\max}(t_1) = 0$.

Assume now that $s_0 < 1$. Hence, we can write

$$\begin{aligned} s_0 u''_{\max} &= s_0 f(\cdot, u_{\max}, u_{\min}) \geq s_0 f\left(\cdot, \frac{1}{s_0} u_{\min}, s_0 u_{\max}\right) \\ &> f(\cdot, u_{\min}, u_{\max}) = u''_{\min}, \end{aligned}$$

which leads to the contradiction

$$0 = (u'_{\min} - s_0 u'_{\max})|_{t_0}^{t_1} = \int_{t_0}^{t_1} (u''_{\min}(t) - s_0 u''_{\max}(t)) dt < 0.$$

A similar argument holds if $t_0 = b$. Hence $s_0 = 1$ and $u_{\max} = u_{\min}$. □

4.5. Historical and bibliographical notes

The idea of associating to a pair of well-ordered lower and upper solutions, monotone sequences of lower and upper solutions converging to solutions is far older than the theory presented here. It goes back at least to Picard whose contribution can be found in two “mémoires”, the first one [79] in 1890 and the second one [80] in 1893. In [80], the author considers the problem

$$u'' + f(t, u) = 0, \quad u(a) = 0, \quad u(b) = 0, \tag{4.32}$$

in case $f(t, \cdot)$ is increasing. He exhibits then a function α_0 such that

$$\alpha''_0 + f(t, \alpha_0) > 0, \quad \text{on }]a, b[, \quad \alpha_0(a) = 0, \quad \alpha_0(b) = 0,$$

i.e., a lower solution, and considers the iterations

$$\alpha''_n + f(t, \alpha_{n-1}) = 0, \quad \alpha_n(a) = 0, \quad \alpha_n(b) = 0.$$

At last he observes that the sequence $(\alpha_n)_n$ is increasing and converges to a solution u of (4.32) greater than α_0 . This gives an approximation process to compute the solutions of (4.32) that we will call *the first monotone approximation scheme*. Theorems 4.4 and 4.7 are very close to this approach.

In [79], Picard introduces a *second monotone approximation scheme*. He studies an elliptic Dirichlet problem in the opposite situation where $f(t, \cdot)$ is decreasing. His main result gives bounds on the solutions of (4.32). Under appropriate assumptions on f , he defines $\alpha_0 = 0$ and considers, for $n \geq 1$, the solutions α_n and β_n of the following problems

$$\begin{aligned}\beta_n'' + f(t, \alpha_{n-1}) &= 0, & \beta_n(a) &= 0, & \beta_n(b) &= 0, \\ \alpha_n'' + f(t, \beta_n) &= 0, & \alpha_n(a) &= 0, & \alpha_n(b) &= 0.\end{aligned}$$

Here $\alpha_n \leq \beta_n$, $(\alpha_n)_n$ is increasing and $(\beta_n)_n$ is decreasing. Hence the sequences $(\alpha_n)_n$ and $(\beta_n)_n$ converge pointwise respectively to functions u and v with $u \leq v$. The author proves in 1898 in case of ODE [83] and in 1900 for the PDE [84], that the convergence is uniform and that the limit functions u and v satisfy

$$\begin{aligned}u'' + f(t, v) &= 0, & u(a) &= 0, & u(b) &= 0, \\ v'' + f(t, u) &= 0, & v(a) &= 0, & v(b) &= 0.\end{aligned}$$

Moreover the solution z of (4.32), which is unique under the given assumptions, is such that

$$u \leq z \leq v.$$

At last, Picard provides in 1894 [81] (see also [82]) an example of a problem (4.32) such that $u \neq v$ which shows that this second approximation scheme does not necessarily converge to a solution of (4.32). This method is described in Proposition 4.12 and Theorem 4.13 which come from [20].

Following Chaplygin [16], the Russian school studies the monotone iterative methods extensively. In 1954, Babkin [9] considers the problem (4.32) under assumptions on $f(t, u)$ which imply the uniqueness of the solutions of (4.32). In his approach, he considers two approximation sequences. Starting from lower and upper solutions α_0 and $\beta_0 \geq \alpha_0$, these approximations are obtained (for $n \geq 1$) as solutions of the linear problem

$$\begin{aligned}-\alpha_n'' + K\alpha_n &= f(t, \alpha_{n-1}) + K\alpha_{n-1}, & \alpha_n(a) &= 0, & \alpha_n(b) &= 0, \\ -\beta_n'' + K\beta_n &= f(t, \beta_{n-1}) + K\beta_{n-1}, & \beta_n(a) &= 0, & \beta_n(b) &= 0.\end{aligned}$$

The main assumption to prove that the sequences $(\alpha_n)_n$ and $(\beta_n)_n$ are monotone and convergent is to choose $K > 0$ such that the function $f(t, u) + Ku$ is increasing in u so that the corresponding differential operator satisfies a maximum principle such as Proposition 4.5 (see [6] or [85]). The observation that the limits of the sequences $(\alpha_n)_n$ and $(\beta_n)_n$ are extremal solutions was noticed in 1962 by Courant and Hilbert [25].

One important step is due to Kantorovich [59] in 1939. He observes that the first approximation scheme, used for the Cauchy problem associated with ODE as well as for other boundary value problem, has a common structure related to positive operators. He then develops an abstract formulation of the method. In 1959, Collatz and Schröder [23] give an abstract formulation of the second monotone approximation scheme. These two abstract formulations have been unified in 1960 by Schröder [93] who shows that the second scheme can be reduced to the first one. Our first section takes into account such an abstract formulation.

The study of the monotone iterative methods for nonlinearities depending on the derivative was initiated in 1964 by Gendzhoyan [43] who considers the problem

$$u'' + f(t, u, u') = 0, \quad u(a) = 0, \quad u(b) = 0.$$

Starting from lower and upper solutions α_0 and $\beta_0 \geq \alpha_0$, he defines sequences of approximations $(\alpha_n)_n$, $(\beta_n)_n$ as solutions of

$$\begin{aligned} -\alpha_n'' + l(t)\alpha_n' + k(t)\alpha_n &= f(t, \alpha_{n-1}, \alpha_{n-1}') + l(t)\alpha_{n-1}' + k(t)\alpha_{n-1}, \\ \alpha_n(a) &= 0, \quad \alpha_n(b) = 0, \\ -\beta_n'' + l(t)\beta_n' + k(t)\beta_n &= f(t, \beta_{n-1}, \beta_{n-1}') + l(t)\beta_{n-1}' + k(t)\beta_{n-1}, \\ \beta_n(a) &= 0, \quad \beta_n(b) = 0, \end{aligned}$$

where $k(t)$ and $l(t)$ are functions related to the assumptions on f . Here also, the convergence is monotone and gives approximations of the solution together with some error bounds. Our Theorems 4.6 and 4.8 simplify considerably this approach. These can be found in [21].

All the above-quoted papers consider the usual order $\alpha \leq \beta$ for the lower and upper solutions. The monotone iterative method was also developed in case lower and upper solutions appear in the reversed order, i.e., $\alpha \geq \beta$. We can first quote the paper of Omari and Trombetta [75] in 1992. They consider problems such as

$$-u'' + cu' + f(t, u) = 0, \quad u(a) = u(b), \quad u'(a) = u'(b).$$

The key assumptions are that the function $f(t, u) - \lambda u$ is nondecreasing in u for some $\lambda < 0$ and that this λ is such that the operator $-u'' + cu' + \lambda u$ is inverse negative on the space of periodic functions, i.e., that an antimaximum principle holds (see Proposition 4.9 [75]). Theorem 4.10 is a particular case of the results in [75]. The Neumann problem was considered by Cabada and Sanchez [15]. We also refer to [14] for other results in this direction. Recently Cherpion, De Coster and Habets [21] worked out an approach of derivative dependent problems very much along the lines of Theorems 4.6 and 4.8. This result is Theorem 4.11.

References

- [1] A. Adje, *Sur et sous-solutions généralisées et problèmes aux limites du second ordre*, Bull. Soc. Math. Belg. Ser. B **42** (1990), 347–368.
- [2] K. Akô, *On the Dirichlet problem for quasi-linear elliptic differential equations of the second order*, J. Math. Soc. Jpn. **13** (1961), 45–62.
- [3] K. Akô, *Subfunctions for ordinary differential equations II*, Funkcialaj Ekvacioj **10** (1967), 145–162.
- [4] H. Amann, *On the existence of positive solutions of nonlinear elliptic boundary value problems*, Indiana Univ. Math. J. **21** (1971), 125–146.
- [5] H. Amann, *On the number of solutions of nonlinear equations in ordered Banach spaces*, J. Funct. Anal. **11** (1972), 346–384.
- [6] H. Amann, *Fixed point equations and nonlinear eigenvalue problems in ordered Banach spaces*, SIAM Rev. **18** (1976), 620–709.
- [7] H. Amann, *A note on degree theory for gradient mappings*, Proc. Amer. Math. Soc. **85** (1982), 591–595.
- [8] H. Amann, A. Ambrosetti and G. Mancini, *Elliptic equations with noninvertible Fredholm linear part and bounded nonlinearities*, Math. Z. **158** (1978), 179–194.
- [9] B.N. Babkin, *Solution of a boundary value problem for an ordinary differential equation of second order by Caplygin's method*, Prikl. Mat. Mekh. Akad. Nauk SSSR **18** (1954), 239–242.
- [10] T. Bartsch and Z.-Q. Wang, *On the existence of sign-changing solutions for semilinear Dirichlet problems*, Topol. Methods Nonlinear Anal. **7** (1996), 115–131.
- [11] S. Bernstein, *Sur certaines équations différentielles ordinaires du second ordre*, C. R. Acad. Sci. Paris **138** (1904), 950–951.
- [12] H. Brezis, *Analyse fonctionnelle, Théorie et applications*, Masson, Paris (1983).
- [13] H. Brezis and L. Nirenberg, *H^1 versus C^1 local minimizers*, C. R. Acad. Sci. Paris **317** (1993), 465–472.
- [14] A. Cabada, P. Habets and R. Pouso, *Optimal existence conditions for Φ -Laplacian equations with upper and lower solutions in the reversed order*, J. Differential Equations **166** (2000), 385–401.
- [15] A. Cabada and L. Sanchez, *A positive operator approach to the Neumann problem for a second order ordinary differential equation*, J. Math. Anal. Appl. **204** (1996), 774–785.
- [16] S.A. Chaplygin, *Complete Works III*, Akademia Nauk SSSR, Leningrad (1935).
- [17] K.C. Chang, *A variant mountain pass lemma*, Scientia Sinica (Ser. A) **26** (1983), 1241–1255.
- [18] K.C. Chang, *Variational methods and sub- and super-solutions*, Scientia Sinica (Ser. A) **26** (1983), 1256–1265.
- [19] K.C. Chang, *Infinite Dimensional Morse Theory and Multiple Solution Problems*, Birkhäuser, Boston (1993).
- [20] M. Cherpion, C. De Coster and P. Habets, *Monotone iterative methods for boundary value problems*, Differential Integral Equations **12** (1999), 309–338.
- [21] M. Cherpion, C. De Coster and P. Habets, *A constructive monotone iterative method for second order BVP in presence of lower and upper solutions*, Appl. Math. Comput. **123** (2001) 75–91.
- [22] J. Ángel Cid, *On extremal fixed points in Schauder's theorem with applications to differential equations*, Bull. Belgian Math. Soc. **11** (2004), 15–20.
- [23] L. Collatz and J. Schröder, *Einschliessen der Lösungen von Randwertaufgaben*, Numer. Math. **1** (1959), 61–72.
- [24] M. Conti, L. Merizzi and S. Terracini, *Remarks on variational methods and lower–upper solutions*, NoDEA Nonlinear Differential Equations Appl. **6** (1999), 371–393.
- [25] R. Courant and D. Hilbert, *Methods of Mathematical Physics, Vol 2: Partial Differential Equations*, Interscience, New York–London (1962).
- [26] E.N. Dancer and Y. Du, *A note on multiple solutions of some semilinear elliptic problems*, J. Math. Anal. Appl. **211** (1997), 626–640.
- [27] C. De Coster, *Pairs of positive solutions for the one-dimensional p -Laplacian*, Nonlinear Anal. TMA **23** (1994), 669–681.
- [28] C. De Coster, *Lower and upper solutions for singular derivative dependent Dirichlet problem*, Math. Inequalities Appl. **4** (2001), 377–396.
- [29] C. De Coster, M.R. Grossinho and P. Habets, *On pairs of positive solutions for a singular boundary value problem*, Appl. Anal. **59** (1995), 241–256.

- [30] C. De Coster and P. Habets, *A two parameters Ambrosetti–Prodi problem*, Portugaliae Math. **53** (1996), 279–303.
- [31] C. De Coster and P. Habets, *Upper and lower solutions in the theory of ODE boundary value problems: classical and recent results*, Nonlinear Analysis and Boundary Value Problems for Ordinary Differential Equations, F. Zanolin, ed., CISM Courses and Lectures, Vol. 371, Springer-Verlag, New York (1996), 1–79.
- [32] C. De Coster and P. Habets, *An overview of the method of lower and upper solutions for ODEs*, Nonlinear Analysis and its Applications to Differential Equations, M.R. Grossinho, M. Ramos, C. Rebelo and L. Sanchez, eds., Progress in Nonlinear Differential Equations and their Applications, Vol. 43, Birkhauser, Boston (2001), 3–22.
- [33] C. De Coster and P. Habets, *On the Method of Lower and Upper Solutions in the Study of Boundary Value Problems*, to appear.
- [34] C. De Coster and M. Henrard, *Existence and localization of solution for elliptic problem in presence of lower and upper solutions without any order*, J. Differential Equations **145** (1998), 420–452.
- [35] C. De Coster and P. Omari, *Unstable periodic solutions of a parabolic problem in presence of non-well-ordered lower and upper solutions*, J. Functional Anal. **175** (2000), 52–88.
- [36] C. De Coster and M. Tarallo, *Foliations, associated reductions and lower-upper solutions*, Calculus Variations PDE **15** (2002), 25–44.
- [37] D.G. de Figueiredo, *Lectures on the Ekeland Variational Principle with Applications and Detours*, Tata Institute of Fundamental Research Lectures on Mathematics and Physics, Vol. 81, Springer-Verlag, Berlin (1989).
- [38] D.G. de Figueiredo and S. Solimini, *A variational approach to superlinear elliptic problems*, Comm. Partial Differential Equations **9** (1984), 699–717.
- [39] T. Ding, R. Iannacci and F. Zanolin, *Existence and multiplicity results for periodic solutions of semilinear Duffing equations*, J. Differential Equations **6** (1993), 364–409.
- [40] H. Epheser, *Über die Existenz der Lösungen von Randwertaufgaben mit gewöhnlichen, nichtlinearen Differentialgleichungen zweiter Ordnung*, Math. Z. **61** (1955), 435–454.
- [41] C. Fabry and P. Habets, *Upper and lower solutions for second-order boundary value problems with nonlinear boundary conditions*, Nonlinear Anal. TMA **10** (1986), 985–1007.
- [42] M. Gaudenzi, P. Habets and F. Zanolin, *Positive solutions of superlinear boundary value problems with singular indefinite weight*, Bull. Belgian Math. Soc. **9** (2002), 607–619.
- [43] G.V. Gendzhoyan, *On two-sided Chaplygin approximations to the solution of the two point boundary value problem*, Izv. Arm. SSR Fiz. Mat. Nauk **17** (1964), 21–27.
- [44] J.-P. Gossez, *Some nonlinear differential equations with resonance at the first eigenvalue*, Confer. Sem. Mat. Univ. Bari **167** (1979), 355–389.
- [45] J.-P. Gossez and P. Omari, *Non-ordered lower and upper solutions in semilinear elliptic problems*, Comm. PDE **19** (1994), 1163–1184.
- [46] V.V. Gudkov and A.J. Lepin, *On necessary and sufficient conditions for the solvability of certain boundary-value problems for a second-order ordinary differential equation*, Dokl. Akad. Nauk SSSR **210** (1973), 800–803.
- [47] P. Habets and M. Laloy, *Perturbations singulières de problèmes aux limites: Les sur- et sous-solutions*, Sémin. Math. Appl. Mécanique UCL **76** (1974).
- [48] P. Habets and P. Omari, *Existence and localization of solutions of second order elliptic problems using lower and upper solutions in the reversed order*, Topol. Methods Nonlinear Anal. **8** (1996), 25–56.
- [49] P. Habets and P. Omari, *Positive solutions of an indefinite prescribed mean curvature problem on a general domain*, Adv. Nonlinear Stud. **4** (2004), 1–13.
- [50] P. Habets and R. Pouso, *Examples of non existence of solution in presence of upper and lower solutions*, ANZIAM J. **44** (2003), 591–594.
- [51] P. Habets and L. Sanchez, *Periodic solutions of some Liénard equations with singularities*, Proc. Amer. Math. Soc. **109** (1990), 1035–1044.
- [52] P. Habets and P. Torres, *Some multiplicity for periodic solutions of a Rayleigh differential equation*, Dyn. Contin. Discrete Impuls. Syst. Ser. A Math. Anal. **8** (2001), 335–351.
- [53] P. Habets and F. Zanolin, *Upper and lower solutions for a generalized Emden–Fowler equation*, J. Math. Anal. Appl. **181** (1994), 684–700.

- [54] P. Habets and F. Zanolin, *Positive solutions for a class of singular boundary value problem*, Boll. Un. Mat. Ital. (7) **9A** (1995), 273–286.
- [55] P. Hess, *On the solvability of nonlinear elliptic boundary value problems*, Indiana Univ. Math. J. **25** (1976), 461–466.
- [56] H. Hofer, *Variational and topological methods in partially ordered Hilbert spaces*, Math. Ann. **261** (1982), 493–514.
- [57] H. Hofer, *A note on the topological degree at a critical point of mountainpass-type*, Proc. Amer. Math. Soc. **90** (1984), 309–315.
- [58] L.K. Jackson, *Subfunctions and second-order ordinary differential inequalities*, Adv. Math. **2** (1967), 307–363.
- [59] L. Kantorovich, *The method of successive approximations for functional equations*, Acta Math. **71** (1939), 63–97.
- [60] J.L. Kelley, *General Topology*, Graduate Texts in Mathematics, Vol. 27, Springer-Verlag, New York (1955).
- [61] I.T. Kiguradze, *A priori estimates for derivatives of bounded functions satisfying second-order differential inequalities*, Differentsial'nye Uravneniya **3** (1967), 1043–1052.
- [62] I.T. Kiguradze, *Some singular boundary value problems for ordinary nonlinear second-order differential equations*, Differentsial'nye Uravneniya **4** (1968), 1753–1773.
- [63] I.T. Kiguradze and B.L. Shekhter, *Singular boundary-value problems for ordinary second-order differential equations*, Itogi Nauki i Tekhniki, Seriya Sovremennyye Problemy Matematiki, Noveishie Dostizheniya **30** (1987), 105–201, translated in J. Soviet Math. **43** (1988), 2340–2417.
- [64] H.W. Knobloch, *Eine neue Methode zur Approximation periodischer Lösungen nichtlinearer Differentialgleichungen zweiter Ordnung*, Math. Z. **82** (1963), 177–197.
- [65] Bongsoo Ko, *The third solution of semilinear elliptic boundary value problems and applications to singular perturbation problems*, J. Differential Equations **101** (1993), 1–14.
- [66] Y.S. Kolesov, *Periodic solutions of quasilinear parabolic equations of second order*, Trans. Moscow Math. Soc. **21** (1970), 114–146.
- [67] S.J. Li and T. Wang, *Mountain pass theorem in order intervals and multiple solutions for semilinear elliptic Dirichlet problems*, J. Anal. Math. **81** (2000), 373–396.
- [68] Zhaoli Liu and Jingxian Sun, *Invariant sets of descending flow in critical point theory with applications to nonlinear differential equations*, J. Differential Equations **172** (2001), 257–299.
- [69] N.G. Lloyd, *Degree Theory*, Cambridge Univ. Press, Cambridge (1978).
- [70] J. Mawhin, *Points fixes, points critiques et problèmes aux limites*, Sémin. de Math. Supérieures, Univ. Montréal (1985).
- [71] W. Mlak, *Parabolic differential inequalities and Chaplighin's method*, Ann. Polon. Math. **8** (1960), 139–152.
- [72] M. Müller, *Über das Fundamentaltheorem in der Theorie der gewöhnlichen Differentialgleichungen*, Math. Z. **26** (1926), 619–649.
- [73] M. Nagumo, *Über die Differentialgleichung $y'' = f(t, y, y')$* , Proc. Phys-Math. Soc. Jpn. **19** (1937), 861–866.
- [74] M. Nagumo, *On principally linear elliptic differential equations of the second order*, Osaka Math. J. **6** (1954), 207–229.
- [75] P. Omari and M. Trombetta, *Remarks on the lower and upper solutions method for second- and third-order periodic boundary value problem*, Appl. Math. Comput. **50** (1992), 1–21.
- [76] P. Omari and F. Zanolin, *Infinitely many solutions of a quasilinear elliptic problem with an oscillatory potential*, Comm. Partial Differential Equations **21** (1996), 721–733.
- [77] G. Peano, *Sull'integrabilità delle equazioni differenziali di primo ordine*, Atti Acad. Torino **21** (1885), 677–685.
- [78] O. Perron, *Ein neuer Existenzbeweis für die Integrale der Differentialgleichung $y' = f(x, y)$* , Math. Ann. **76** (1915), 471–484.
- [79] E. Picard, *Mémoire sur la théorie des équations aux dérivées partielles et la méthode des approximations successives*, J. Math. **6** (1890), 145–210.
- [80] E. Picard, *Sur l'application des méthodes d'approximations successives à l'étude de certaines équations différentielles ordinaires*, J. Math. **9** (1893), 217–271.

- [81] E. Picard, *Sur un exemple d'approximations successives divergentes*, Comptes Rendus **118** (1894), 899–902.
- [82] E. Picard, *Traité d'analyse, III*, Gauthier-Villars, Paris (1896).
- [83] E. Picard, *Sur certains exemples singuliers d'approximations successives*, Comptes Rendus **126** (1898), 497–500.
- [84] E. Picard, *Sur un exemple d'approximations successives divergentes*, Bull. Soc. Math. **28** (1900), 137–143.
- [85] M.H. Protter and H.F. Weinberger, *Maximum Principles in Differential Equations*, Prentice–Hall, Englewood Cliffs (1967).
- [86] G. Prodi, *Teoremi di esistenza per equazioni alle derivate parziali non lineari di tipo parabolico, Nota I e II*, Rend. Ist. Lombardo **86** (1953), 1–47.
- [87] I. Rachůnková and M. Tvrdý, *Nonlinear systems of differential inequalities and solvability of certain boundary value problems*, J. Inequal. Appl. **6** (2001), 199–226.
- [88] A. Rosenblatt, *Sur les théorèmes de M. Picard dans la théorie des problèmes aux limites des équations différentielles ordinaires non linéaires*, Bull. Sci. Math. **57** (1933), 100–106.
- [89] T. Satō, *Sur l'équation aux dérivées partielles $\Delta z = f(x, y, z, p, q)$* , Compositio Math. **12** (1954), 157–177.
- [90] T. Satō, *Sur l'équation aux dérivées partielles $\Delta z = f(x, y, z, p, q)$ II*, Compositio Math. **14** (1959), 152–171.
- [91] D.H. Sattinger, *Monotone methods in nonlinear elliptic and parabolic boundary value problems*, Indiana Univ. Math. J. **21** (1972), 979–1000.
- [92] K. Schmitt, *Boundary value problems for quasilinear second order elliptic equations*, Nonlinear Anal. TMA **2** (1978), 263–309.
- [93] J. Schröder, *Anwendungen von Fixpunktsätzen bei der numerischen Behandlung nichtlinearer Gleichungen in halbgeordneten Räumen*, Arch. Rat. Mech. Anal. **4** (1959/1960), 177–192.
- [94] G. Scorza Dragoni, *Il problema dei valori ai limiti studiato in grande per gli integrali di una equazione differenziale del secondo ordine*, Giornale Mat. (Battaglini) **69** (1931), 77–112.
- [95] G. Scorza Dragoni, *Il problema dei valori ai limiti studiato in grande per le equazioni differenziali del secondo ordine*, Math. Ann. **105** (1931), 133–143.
- [96] G. Scorza Dragoni, *Elementi uniti di trasformazioni funzionali e problemi di valori ai limiti*, Rend. Semin. Mat. R. Univ. Roma **2** (1938), 255–275.
- [97] G. Scorza Dragoni, *Intorno a un criterio di esistenza per un problema di valori ai limiti*, Rend. Semin. R. Accad. Naz. Lincei **28** (1938), 317–325.
- [98] R. Shivaji, *A remark on the existence of three solutions via sub-super solutions*, Nonlinear Analysis and Applications, V. Lakshmikantham, ed., Dekker, New York–Basel (1987), 561–566.
- [99] G. Stampacchia, *Le problème de Dirichlet pour les équations elliptiques du second ordre à coefficients discontinus*, Ann. Inst. Fourier **15** (1965), 189–258.
- [100] J. Szarski, *Differential Inequalities*, Monografie Matematyczne, Vol. 43, Warszawa (1965).
- [101] W. Walter, *Differential and Integral Inequalities*, Springer-Verlag, New York (1970).

Half-Linear Differential Equations

O. Došlý

Masaryk University, Department of Mathematics, Janackovo nam. 2A, 662 95 Brno, Czech Republic
E-mail: dosly@math.muni.cz

Contents

Preface	165
3A. Basic Theory	167
1. Existence and uniqueness	167
1.1. First order half-linear system	167
1.2. Half-linear trigonometric functions	168
1.3. Half-linear Prüfer transformation	169
1.4. Existence and uniqueness	170
2. Sturmian theory	171
2.1. Riccati equation	171
2.2. Picone's identity	172
2.3. Energy functional	174
2.4. Roundabout theorem	174
2.5. Sturmian separation and comparison theorems	176
2.6. Transformation of independent variable	177
2.7. Reciprocity principle	178
2.8. Leighton–Wintner oscillation criterion	178
3. Differences between linear and half-linear equations	180
3.1. Wronskian identity	180
3.2. Transformation formula	181
3.3. Fredholm alternative	182
4. Some elementary half-linear equations	183
4.1. Equations with constant coefficients	183
4.2. Euler-type half-linear differential equation	188
4.3. Kneser-type oscillation and nonoscillation criteria	194
3B. Nonoscillatory Equations	197
5. Nonoscillation criteria	197
5.1. Variational principle and Wirtinger's inequality	197
5.2. Nonoscillation criteria via Wirtinger inequality	198
5.3. Riccati inequality	200
5.4. Half-linear Hartman–Wintner theorem	203

5.5. Riccati integral equation and Hille–Wintner comparison theorem	206
5.6. Hille–Nehari criteria	208
5.7. Modified Hille–Nehari’s criteria	209
5.8. Comparison theorem with respect to p	214
6. Asymptotic of nonoscillatory solutions	215
6.1. Integral conditions and classification of solutions	215
6.2. The case c negative	218
6.3. Uniqueness in \mathbb{M}^-	224
6.4. The case c positive	226
7. Principal solution	229
7.1. Principal solution of linear equations	229
7.2. Mirzov’s construction of the principal solution	231
7.3. Construction of Elbert and Kusano	232
7.4. Comparison theorem for eventually minimal solutions of Riccati equations	234
7.5. Sturmian property of the principal solution	235
7.6. Integral characterization of the principal solution	236
7.7. Another integral characterization	240
7.8. Limit characterization of the principal solution	241
8. Conjugacy and disconjugacy of half-linear equations	241
8.1. Leighton’s conjugacy criterion	241
8.2. Singular Leighton’s theorem	242
8.3. Lyapunov inequality	246
8.4. Vallée Poussin-type inequality	248
8.5. Focal point criteria	249
8.6. Lyapunov-type focal points and conjugacy criteria	252
3C. Oscillatory Equations	255
9. Oscillation criteria	255
9.1. General observations	255
9.2. Coles-type criteria	256
9.3. Generalized Hartman–Wintner’s criterion	261
9.4. Generalized Kamenev criterion	263
9.5. Another refinement of the Hartman–Wintner theorem	264
9.6. Half-linear Willet’s criteria	266
9.7. Equations with periodic coefficient	268
9.8. Equations with almost periodic coefficient	270
9.9. Generalized H -function averaging technique	272
10. Various oscillation problems	275
10.1. Asymptotic formula for distance of zeros of oscillatory solutions	275
10.2. Half-linear Milloux and Armellini–Tonelli–Sansone theorems	279
10.3. Strongly and conditionally oscillatory equation	283
10.4. Oscillation of forced half-linear differential equations	284
10.5. Oscillation of retarded half-linear equations	286
11. Half-linear Sturm–Liouville problem	293
11.1. Basic Sturm–Liouville problem	293
11.2. Regular problem with indefinite weight	295
11.3. Singular Sturm–Liouville problem	300
12. Perturbation principle	302
12.1. General idea	302
12.2. Leighton–Wintner type oscillation criterion	303
12.3. Hille–Nehari-type oscillation criterion	304
12.4. Hille–Nehari-type nonoscillation criterion	308
12.5. Perturbed Euler equation	310

3D. Related Equations and Problems	313
13. Half-linear boundary value problems	313
13.1. Basic boundary value problem	313
13.2. Variational characterization of eigenvalues	314
13.3. Nonresonance problem	315
13.4. Fredholm alternative for the scalar p -Laplacian	317
13.5. Homotopic deformation along p and Leray–Schauder degree	319
13.6. Resonance problem	321
14. Quasilinear and related differential equations	322
14.1. Equation (14.1) with constant coefficients	323
14.2. Emden–Fowler type equation	326
14.3. More about quasilinear equations	327
15. Partial differential equations with p -Laplacian	329
15.1. Dirichlet BVP with p -Laplacian	330
15.2. Picone’s identity for equations with p -Laplacian	333
15.3. Second eigenvalue of p -Laplacian	335
15.4. Equations involving pseudolaplacian	336
16. Half-linear difference equations	337
16.1. Roundabout theorem for half-linear difference equations	338
16.2. Discrete Leighton–Wintner criterion	341
16.3. Riccati inequality	343
16.4. Hille–Nehari nonoscillation criterion	345
16.5. Half-linear dynamic equations on time scales	348
References	349

This Page Intentionally Left Blank

Preface

In this part of the book we deal with the half-linear second order differential equation

$$(r(t)\Phi(x'))' + c(t)\Phi(x) = 0, \quad \Phi(x) := |x|^{p-1} \operatorname{sgn} x, \quad p > 1, \quad (\text{HL})$$

where r, c are continuous functions and $r(t) > 0$. The investigation of solutions of (HL) has attracted considerable attention in the last two decades, and it was shown that solutions of this equation behave in many aspects like those of the Sturm–Liouville equation

$$(r(t)x')' + c(t)x = 0 \quad (\text{SL})$$

which is the special case of (HL) when $p = 2$. The aim of this part is to present the substantial results of this investigation. We show similarities in qualitative behavior of solutions of (HL) and (SL), we also point out phenomena where properties of solutions of (HL) and (SL) (considerably) differ. Note that the term half-linear equations is motivated by the fact that the solution space of (HL) has just one half of the properties which characterize linearity, namely homogeneity (but not additivity).

The investigation of qualitative properties of nonlinear second order differential equations has a long history. Recall here only the papers of Emden [95], Fowler [102], Thomas [211], and the book of Sansone [206] containing the survey of the results achieved in the first half of the last century. In the fifties and the later decades the number of papers devoted to nonlinear second order differential equations increased rapidly, so we mention here only treatments directly associated with (HL). Even if some ideas concerning the properties of solutions of (HL) can already be found in the papers of Bihari [20,21], Elbert and Mirzov with their papers [85,176] are the ones usually regarded as pioneers of the qualitative theory of (HL). In later years, in particular in the nineties, the striking similarity between oscillatory properties of (HL) and (SL) was revealed. On the other hand, in some aspects, e.g., the Fredholm-type alternative for solutions of boundary value problems associated with (HL), it turned out that the situation is completely different in the linear and half-linear case, and that the absence of additivity of the solution space of (HL) brings completely new phenomena.

This part of the book is divided into four chapters. In the first one we present a brief survey of the basic properties of solutions of (HL). A particular attention is devoted to the existence, uniqueness, Sturmian theory and to some elementary half-linear differential equations. Then we turn our attention to the oscillation theory of half-linear equations. First we deal with nonoscillatory equations and nonoscillation criteria (Chapter 3B), and in Chapter 3C we deal with their oscillation counterparts. We also present some related

results concerning asymptotic behavior of nonoscillatory solutions and properties of some distinguished solutions of (HL). In the last chapter we deal with boundary value problems associated with (HL) (in this part of the qualitative theory of (HL) we can see the biggest difference between linear and half-linear second order differential equations), and with equations related to (HL), in particular, with partial differential equations with p -Laplacian, quasilinear equations and half-linear difference equations.

Comparing our treatment of half-linear differential equations with Chapter 3C of the recent book [3] (this chapter is devoted to the oscillation theory of (HL), there are some common points, but the most part of our presentation differ from that of [3]. More precisely, the treatment analogous to Sections 1.3, 1.4, 2.2, 2.3, 3.3, 3.4 and the whole Chapter 3D are missing in [3]. On the other hand, [3] devotes more space to particular (non)oscillation criteria, to forced half-linear equations and to equations with deviated argument. Moreover, the parts which overlap here and in [3] are presented from a different point of view.

I would like to thank Prof. Mariella Cecchi and Prof. Mauro Marini from the University of Florence, who prepared the section devoted to the asymptotics of nonoscillatory solutions of (HL) (Section 6), and to Assoc. Prof. Jaromír Kuben for his help with the \LaTeX elaboration of the text. My special thanks belong to my colleague Dr. Pavel Řehák, who read the whole text, for numerous helpful suggestions and comments to the final version of this text.

The preparation of this part of the book was supported by the Grant 201/01/0079 of the Grant Agency of the Czech Republic and by the Research Project J07/98/143100001 of the Czech Government.

December 2003

Ondřej Došlý

Basic Theory

In this chapter we deal with the basic properties of solutions of the half-linear second order differential equation

$$(r(t)\Phi(x'))' + c(t)\Phi(x) = 0, \quad \Phi(x) := |x|^{p-1} \operatorname{sgn} x, \quad p > 1. \quad (0.1)$$

We suppose that the functions r, c are continuous and $r(t) > 0$ in the interval under consideration. In the first section we deal with the existence and the unique solvability of (0.1). Then we present the basic oscillatory properties of (0.1), in particular, we show that the linear Sturmian oscillation theory extends almost verbatim to half-linear equations. In Section 3 we show basic differences between second order linear and half-linear equations. The last section of this chapter deals with some special half-linear equations.

1. Existence and uniqueness

1.1. First order half-linear system

Consider the Sturm–Liouville *linear* differential equation

$$(r(t)x')' + c(t)x = 0 \quad (1.1)$$

which is a special case $p = 2$ in (0.1). Then, given $t_0, x_0, x_1 \in \mathbb{R}$, there exists the unique solution of (1.1) satisfying the initial conditions $x(t_0) = x_0, x'(t_0) = x_1$, which is extensible over the whole interval where the functions r, c are continuous and $r(t) > 0$. This follows, e.g., from the fact that (1.1) can be written as the 2-dimensional first order linear system

$$x' = \frac{1}{r(t)}u, \quad u' = -c(t)x$$

and the linearity (hence Lipschitz property) of this system implies the above mentioned statement concerning the existence and unique solvability of (1.1). On the other hand, if we rewrite (0.1) into the first order system (substituting $u = r\Phi(x')$), we get the system

$$x' = r^{1-q}(t)\Phi^{-1}(u), \quad u' = -c(t)\Phi(x), \quad (1.2)$$

where q is the conjugate number of p , i.e., $\frac{1}{p} + \frac{1}{q} = 1$, and Φ^{-1} is the inverse function of Φ . The right hand-side of (1.2) is no longer Lipschitzian in x, u , hence the standard

existence and uniqueness theorems do not apply directly to this system. Moreover, it is known that the so-called Emden–Fowler differential equation

$$x'' + p(t)|x|^{\alpha-2}x = 0, \quad \alpha > 1, \quad (1.3)$$

(which looks similarly to (0.1)) admits the so-called singular solutions (see Section 14.2 and, e.g., the books [127,178]), i.e., solutions which violate uniqueness and continuability of solutions of (1.3).

1.2. Half-linear trigonometric functions

In proving the existence and uniqueness result for (0.1), the fundamental role is played by the generalized Prüfer transformation introduced in [85]. Consider a special half-linear equation of the form (0.1)

$$(\Phi(x'))' + (p-1)\Phi(x) = 0 \quad (1.4)$$

and denote by $S = S(t)$ its solution given by the initial conditions $S(0) = 0$, $S'(0) = 1$. We will show that the behavior of this solution is very similar to that of the classical sine function. Multiplying (1.4) (with x replaced by S) by S' and using the fact that $(\Phi(S'))' = (p-1)|S'|^{p-2}S''$, we get the identity $[|S'|^p + |S|^p]' = 0$. Substituting here $t = 0$ and using the initial condition for S we have the generalized Pythagorean identity

$$|S(t)|^p + |S'(t)|^p \equiv 1. \quad (1.5)$$

The function S is positive in some right neighborhood of $t = 0$ and using (1.5) $S' = \sqrt[p]{1-S^p}$, i.e., $\frac{dS}{\sqrt[p]{1-S^p}} = dt$ in this neighborhood, hence

$$t = \int_0^{S(t)} (1-s^p)^{-\frac{1}{p}} ds. \quad (1.6)$$

Following the analogy with the case $p = 2$, we denote

$$\frac{\pi_p}{2} = \int_0^1 (1-s^p)^{-\frac{1}{p}} ds = \frac{1}{p} \int_0^1 (1-u)^{-\frac{1}{p}} u^{-\frac{1}{q}} du = \frac{1}{p} B\left(\frac{1}{p}, \frac{1}{q}\right),$$

where

$$B(x, y) = \int_0^1 t^{x-1} (1-t)^{y-1} dt$$

is the Euler beta function. Using the formulas

$$B(x, y) = \frac{\Gamma(x)\Gamma(y)}{\Gamma(x+y)}, \quad \Gamma(x)\Gamma(1-x) = \frac{\pi}{\sin \pi x}$$

with the Euler gamma function $\Gamma(x) = \int_0^\infty t^{x-1} e^{-t} dt$, we have

$$\pi_p = \frac{2\pi}{p \sin \frac{\pi}{p}}. \tag{1.7}$$

The formula (1.6) defines uniquely the function $S = S(t)$ on $[0, \pi_p/2]$ with $S(\pi_p/2) = 1$ and hence by (1.5) $S'(\pi_p/2) = 0$. Now we define the generalized sine function S_p on the whole real line as the odd $2\pi_p$ periodic continuation of the function

$$S_p(t) = \begin{cases} S(t), & 0 \leq t \leq \frac{\pi_p}{2}, \\ S(\pi_p - t), & \frac{\pi_p}{2} \leq t \leq \pi_p. \end{cases}$$

The function S_p reduces to the classical function \sin in case $p = 2$ and in some literature (e.g., [73]) this function is denoted by $\sin_p t$. We will skip the index p by S_p if no ambiguity may occur.

In addition, we introduce the half-linear tangent and cotangent functions \tan_p and \cot_p by

$$\tan_p t = \frac{S_p(t)}{S'_p(t)}, \quad \cot_p t = \frac{S'_p(t)}{S_p(t)}.$$

The function \tan_p is periodic with the period π_p and has discontinuities at $\pi_p/2 + k\pi_p$, $k \in \mathbb{Z}$. The function \cot_p is also π_p periodic, with discontinuities at $t = k\pi_p$, $k \in \mathbb{Z}$. By (1.4) and (1.5) we have

$$\begin{aligned} (\tan_p t)' &= \frac{1}{|S'_p(t)|^p} = 1 + |\tan_p t|^p, \\ (\cot_p t)' &= -|\cot_p t|^{2-p} (1 + |\cot_p t|^p). \end{aligned} \tag{1.8}$$

Hence $(\tan_p t)' > 0$, $(\cot_p t)' < 0$ on their definition domains and there exists the inverse functions \arctan_p , arccot_p which are defined as inverse functions of \tan_p and \cot_p in the domains $(-\pi_p/2, \pi_p/2)$ and $(0, \pi_p)$, respectively. From (1.8) we have

$$(\arctan_p t)' = \frac{1}{1 + |t|^p},$$

1.3. Half-linear Prüfer transformation

Using the above defined generalized trigonometric functions and their inverse functions, we can introduce the generalized Prüfer transformation as follows. Let x be a nontrivial solution of (0.1). Put

$$\rho(t) = \sqrt[p]{|x(t)|^p + r^q(t)|x'(t)|^p}$$

and let φ be a continuous function defined at all points where $x(t) \neq 0$ by the formula

$$\varphi(t) = \operatorname{arccot}_p \frac{r^{q-1}(t)x'(t)}{x(t)},$$

where q is the conjugate number of p , i.e., $\frac{1}{p} + \frac{1}{q} = 1$. Hence

$$x(t) = \rho(t)S(\varphi(t)), \quad r^{q-1}(t)x'(t) = \rho(t)S'(\varphi(t)). \quad (1.9)$$

Differentiating the first equality in (1.9) and comparing it with the second one we get

$$r^{1-q}(t)\rho(t)S'(\varphi(t)) = \rho'(t)S(\varphi(t)) + \rho(t)S'(\varphi(t))\varphi'(t). \quad (1.10)$$

Similarly, applying the function Φ to both sides of the second equation in (1.9), differentiating the obtained identity and substituting from (0.1) we get

$$\begin{aligned} -c(t)\rho^{p-1}(t)\Phi(S(\varphi(t))) &= (p-1)[\rho^{p-2}(t)\rho'(t)\Phi(S'(\varphi(t))) \\ &\quad - \rho^{p-1}(t)\Phi(S(\varphi(t)))\varphi'(t)]. \end{aligned} \quad (1.11)$$

Now, multiplying (1.10) by $\Phi(S')/\rho$, (1.11) by S/ρ^{p-1} and combining the obtained equations we get the first order system for φ and ρ

$$\begin{aligned} \varphi' &= \frac{c(t)}{p-1}|S(\varphi)|^p + r^{1-q}(t)|S'(\varphi)|^p, \\ \rho' &= \Phi(S(\varphi(t)))S'(\varphi(t))\left[r^{1-q}(t) - \frac{c(t)}{p-1}\right]\rho. \end{aligned} \quad (1.12)$$

1.4. Existence and uniqueness

Since the right-hand side of the last system is Lipschitzian in ρ, φ , the initial value problem for this system is uniquely solvable and its solution exists on the whole interval where r, c are continuous and $r(t) > 0$. Hence, the same holds for (0.1). This statement is summarized in the next theorem.

THEOREM 1.1. *Suppose that the functions r, c are continuous in an interval $I \subseteq \mathbb{R}$ and $r(t) > 0$ for $t \in I$. Given $t_0 \in I$ and $A, B \in \mathbb{R}$, there exists a unique solution of (0.1) satisfying $x(t_0) = A, x'(t_0) = B$ which is extensible over the whole interval I . This solution depends continuously on the initial values A, B .*

REMARK 1.1. The half-linear Prüfer transformation and the resulting existence and uniqueness theorem are presented in [85]. Another pioneering work in the theory of half-linear equations is the paper of Mirzov [176]. In that paper, the first order system

$$u'_1 = a_1(t)|u_2|^{\lambda_1} \operatorname{sgn} u_2, \quad u'_2 = a_2(t)|u_1|^{\lambda_2} \operatorname{sgn} u_1 \quad (1.13)$$

is considered, where $\lambda_1, \lambda_2 > 0$ and $\lambda_1 \lambda_2 = 1$. Comparing with (1.2), system (1.13) is slightly more general since the function a_1 (in contrast to the function r^{1-q} in (1.2)) can attain zero values. First, using Bellman’s lemma [17, p. 46], Mirzov proves that the trivial solution $(u_1, u_2) \equiv (0, 0)$ is the only solution satisfying the zero initial condition $u_1(t_0) = 0 = u_2(t_0)$, and that under the assumption of local integrability of the functions a_1, a_2 every solution of (1.13) is extensible over the whole interval where the integrability assumption is satisfied. Then, under the assumption that the functions a_1, a_2 do not change their signs, the Sturmian type theorem with respect to both components is proved using essentially the same method as described in the next section.

2. Sturmian theory

In this section we establish the basic oscillatory properties of half-linear equation (0.1). In particular, we show that the methods of the half-linear oscillation theory are similar to those of the oscillation theory of Sturm–Liouville linear equations (1.1), and that the Sturmian theory extends verbatim to (0.1).

2.1. Riccati equation

Let x be a solution of (0.1) such that $x(t) \neq 0$ in an interval I . Then $w(t) = \frac{r(t)\Phi(x'(t))}{\Phi(x(t))}$ is a solution of the Riccati-type differential equation

$$w' + c(t) + (p - 1)r^{1-q}(t)|w|^q = 0, \tag{2.1}$$

where q is the conjugate number of p , i.e., $q = \frac{p}{p-1}$. Indeed, in view of (0.1) we have

$$\begin{aligned} w' &= \frac{(r\Phi(x'))'\Phi(x) - (p - 1)r\Phi(x')|x|^{p-2}x'}{\Phi^2(x)} = -c - (p - 1)\frac{r|x'|^p}{|x|^p} \\ &= -c - (p - 1)r^{1-q}|w|^q. \end{aligned}$$

REMARK 2.1. (i) Using the above Riccati equation (2.1) one can derive the first equation in (1.12) as follows. From (1.9) we have

$$w = \frac{r(t)\Phi(x'(t))}{\Phi(x(t))} = \frac{\Phi(S'(\varphi(t)))}{\Phi(S(\varphi(t)))} =: v(\varphi(t)).$$

The function $v = \Phi(S')/\Phi(S)$ satisfies the Riccati equation corresponding to (1.4). This implies

$$\begin{aligned} [v(\varphi(t))] &' = v'(\varphi(t))\varphi'(t) = \left[- (p - 1) - (p - 1) \left| \frac{\Phi(S'(\varphi(t)))}{\Phi(S(\varphi(t)))} \right|^q \right] \varphi'(t) \\ &= -(p - 1) \left[1 + \left| \frac{S'(\varphi(t))}{S(\varphi(t))} \right|^p \right] \varphi'(t), \end{aligned}$$

Substituting from (2.1)

$$w'(t) = -c(t) - (p-1)r^{1-q}(t)|w(t)|^q = -c(t) - (p-1)r^{1-q}(t)\left|\frac{S'(\varphi)}{S(\varphi)}\right|^p$$

and hence

$$c(t) + (p-1)r^{1-q}(t)\left|\frac{S'(\varphi(t))}{S(\varphi(t))}\right|^p = (p-1)\left[1 + \left|\frac{S'(\varphi(t))}{S(\varphi(t))}\right|^p\right]\varphi'(t).$$

Multiplying this equation by $|S(\varphi(t))|^p$ and using (1.5) we get really the first equation in (1.12).

(ii) Sometimes it is convenient to use a more general Riccati substitution

$$v(t) = \frac{f(t)r(t)\Phi(x'(t))}{\Phi(x(t))},$$

where f is a differentiable function. By a direct computation one can verify that v satisfies the first order Riccati-type equation

$$v' - \frac{f'(t)}{f(t)}v + f(t)c(t) + (p-1)r^{1-q}(t)f^{1-q}(t)|v|^q = 0. \quad (2.2)$$

The application of this more general Riccati substitution in the oscillation theory of (0.1) will be shown in Chapter 3C.

(iii) If we consider a slightly more general half-linear equation

$$(r(t)\Phi(x'))' + b(t)\Phi(x') + c(t)\Phi(x) = 0, \quad (2.3)$$

the Riccati substitution $w = r\Phi(x')/\Phi(x)$ leads to the equation

$$w' + c(t) + \frac{b(t)}{r(t)}w + (p-1)r^{1-q}(t)|w|^q = 0. \quad (2.4)$$

Multiplying this equation by $\exp\{f^t \frac{b(s)}{r(s)} ds\} =: g(t)$ and denoting $v = gw$, Equation (2.4) can be written in the same form as (2.1)

$$v' + c(t)g(t) + (p-1)r^{1-q}(t)g^{1-q}(t)|v|^q = 0.$$

The same effect we achieve if we multiply the original equation (2.3) by g since then this equation can be again written in the form (0.1).

2.2. Picone's identity

The original Picone's identity [190] for the linear second order equation (1.1) was established in 1910. Since that time, this identity has been extended in various directions and the half-linear version of this identity (proved in [115]) reads as follows.

THEOREM 2.1. Consider a pair of half-linear differential operators

$$l(x) = (r(t)\Phi(x'))' + c(t)\Phi(x), \quad L(y) = (R(t)\Phi(y'))' + C(t)\Phi(y)$$

and let x, y be continuously differentiable functions such that $r\Phi(x'), R\Phi(y')$ are also continuously differentiable and $y(t) \neq 0$ in an interval $I \subset \mathbb{R}$. Then in this interval

$$\begin{aligned} & \left\{ \frac{x}{\Phi(y)} [\Phi(y)r\Phi(x') - \Phi(x)R\Phi(y')] \right\}' \\ &= (r - R)|x'| + (C - c)|x|^p + pR^{1-q}P(R^{q-1}x', R\Phi(xy'/y)) \\ & \quad + \frac{x}{\Phi(y)} [\Phi(y)l(x) - \Phi(x)L(y)], \end{aligned} \tag{2.5}$$

where

$$P(u, v) := \frac{|u|^p}{p} - uv + \frac{|v|^q}{q} \geq 0 \tag{2.6}$$

with equality if and only if $v = \Phi(u)$.

PROOF. The identity (2.5) can be verified by a direct computation, inequality (2.6) is the classical Young inequality, see, e.g., [105]. \square

In the particular case when $r = R, C = c, y$ is a nonzero solution of the equation $L(y) = 0$ and $w = R\Phi(y')/\Phi(y)$, then (2.5) reduces to the identity

$$r(t)|x'|^p - c(t)|x|^p = (w(t)|x|^p)' + pr^{1-q}(t)P(r^{q-1}(t)x', \Phi(x)w(t)). \tag{2.7}$$

This reduced Picone's identity will be used frequently in the sequel.

We will also need the following auxiliary statement which compares the function P with a certain quadratic function.

LEMMA 2.1. The function $P(u, v)$ defined in (2.6) satisfies the following inequalities

$$P(u, v) \geq \frac{1}{2}|u|^{2-p}(\Phi(u) - v)^2, \quad p \leq 2, \Phi(u) \neq v, u \neq 0 \tag{2.8}$$

and

$$P(u, v) \leq \frac{1}{2(p-1)}|u|^{2-p}(\Phi(u) - v)^2, \quad p \leq 2, |\Phi(u)| > |v|, uv > 0. \tag{2.9}$$

More generally, for every $T > 0$ there exists a constant $K = K(T)$ such that

$$P(u, v) \geq K(T)|u|^{2-p}(\Phi(u) - v)^2, \quad p \geq 2, \quad \Phi(u) \neq v, \quad \left| \frac{v}{\Phi(u)} \right| < T. \quad (2.10)$$

PROOF. We present an outline of the proof only, for details we refer to [66,72]. We have

$$P(u, v) = |u|^p \left\{ \frac{1}{q} \left| \frac{v}{\Phi(u)} \right|^q - \frac{v}{\Phi(u)} + \frac{1}{p} \right\}$$

and

$$|u|^{2-p}(v - \Phi(u))^2 = |u|^p \left(\frac{v}{\Phi(u)} - 1 \right)^2.$$

Denote $F(t) = \frac{1}{q}|t|^q - t + \frac{1}{p}$, $G(t) = \frac{1}{2}(t - 1)^2$. The function $H = F - G$ satisfies $H(-1) = 0 = H(1)$, $H(0) = \frac{1}{p} - \frac{1}{2} \geq 0$ for $p \leq 2$ and a closer investigation of the graph of this function shows that (2.8) and (2.10) really hold. \square

2.3. Energy functional

The p -degree functional

$$\mathcal{F}(y; a, b) = \int_a^b [r(t)|y'|^p - c(t)|y|^p] dt \quad (2.11)$$

considered over the Sobolev space $W_0^{1,p}(a, b)$ is usually called the *energy functional* of (0.1). Recall that the Sobolev space $W_0^{1,p}(a, b)$ consists of absolutely continuous functions x whose derivative is in $L^p(a, b)$ and $x(a) = 0 = x(b)$, with the norm $\|x\| = (\int_a^b [|x'|^p + |x|^p] dt)^{1/p}$. Equation (0.1) is the Euler–Lagrange equation of the first variation of the functional \mathcal{F} . Moreover, if x is a solution of (0.1) satisfying $x(a) = 0 = x(b)$, then using integration by parts we have

$$\mathcal{F}(x; a, b) = [r(t)x(t)\Phi(x'(t))]_a^b - \int_a^b x(t)[(r(t)\Phi(x'))' + c(t)\Phi(x)] dt = 0. \quad (2.12)$$

2.4. Roundabout theorem

This theorem relates Riccati equation (2.1), the energy functional (2.11) and the basic oscillatory properties of solutions of (0.1). The terminology Roundabout theorem is motivated

by the fact that the proof of this theorem consists of the “roundabout” proof of several equivalent statements.

Equation (0.1) is said to be *disconjugate* on the closed interval $[a, b]$ if the solution x given by the initial condition $x(a) = 0, r(a)\Phi(x'(a)) = 1$ has no zero in $(a, b]$, in the opposite case (0.1) is said to be *conjugate* on $[a, b]$.

THEOREM 2.2. *The following statements are equivalent.*

- (i) Equation (0.1) is *disconjugate* on the interval $I = [a, b]$. (0.1) has at most one.
- (ii) There exists a solution of (0.1) having no zero in $[a, b]$.
- (iii) There exists a solution w of the generalized Riccati equation (2.1) which is defined on the whole interval $[a, b]$.
- (iv) The energy functional $\mathcal{F}(y; a, b)$ is positive for every $0 \neq y \in W_0^{1,p}(a, b)$.

PROOF. (i) \Rightarrow (ii): Consider the solution \tilde{x} of (0.1) given by the initial condition $\tilde{x}(a) = \varepsilon, r(a)\Phi(\tilde{x}'(a)) = 1$, where $\varepsilon > 0$ is sufficiently small. Then, according to the continuous dependence of solutions of (0.1) on the initial condition, disconjugacy of (0.1) on $[a, b]$ implies that this solution is positive on this interval.

(ii) \Rightarrow (iii): This implication is the immediate consequence of the Riccati substitution from Section 2.1.

(iii) \Rightarrow (iv): If there exists a solution w of (2.1) defined in the whole interval $[a, b]$, then by integrating the reduced Picone identity (2.7) with $x \in W_0^{1,p}(a, b)$ we get

$$\mathcal{F}(x; a, b) = p \int_a^b r^{1-q}(t)P(r^{q-1}(t)x', \Phi(x)w(t)) dt \geq 0$$

with equality only if and only if $\Phi(r^{q-1}(t)x') = \Phi(x)w(t)$, i.e., $x' = \Phi^{-1}(w(t)/r(t))x$ in $[a, b]$, thus

$$x(t) = x(a) \exp \left\{ \int_a^t \Phi^{-1} \left(\frac{w(s)}{r(s)} \right) ds \right\} \equiv 0$$

since $x(a) = 0$. This means that $\mathcal{F}(x; a, b) \geq 0$ over $W_0^{1,p}(a, b)$ with equality only if $x(t) \equiv 0$.

(iv) \Rightarrow (i): Suppose that $\mathcal{F} > 0$ over nontrivial $y \in W_0^{1,p}(a, b)$ and (0.1) is not *disconjugate* in $[a, b]$, i.e., the solution x of (0.1) given by the initial condition $x(a) = 0, r(a)\Phi(x'(a)) = 1$ has a zero $c \in [a, b]$. Define the function $y \in W_0^{1,p}(a, b)$ as follows

$$y(t) = \begin{cases} x(t), & t \in [a, c], \\ 0, & t \in [c, b]. \end{cases}$$

Then by (2.12)

$$\mathcal{F}(y; a, b) = \mathcal{F}(y; a, c) = \mathcal{F}(x; a, c) = 0$$

which contradicts the positivity of \mathcal{F} . □

REMARK 2.2. Similarly to the linear case, two points $t_1, t_2 \in \mathbb{R}$ are said to be *conjugate relative to (0.1)* if there exists a nontrivial solution x of this equation such that $x(t_1) = 0 = x(t_2)$. Due to Theorem 2.2, disconjugacy and conjugacy of (0.1) on a bounded interval $I \subset \mathbb{R}$ can be equivalently defined as follows. Equation (0.1) is said to be *disconjugate* on an interval I if this interval contains no pair of points conjugate relative to (0.1) (i.e., every nontrivial solution has at most one zero in I), in the opposite case (0.1) is said to be *conjugate* on I (i.e., there exists a nontrivial solution with at least two zeros in I). In Section 7 we will show that using the concept of the principal solution of (0.1), this equivalent definition applies also to unbounded intervals.

2.5. Sturmian separation and comparison theorems

The Roundabout theorem shows that the linear Sturmian theorems extend verbatim to half-linear equation (0.1). Indeed, the following theorem follows from the equivalence of (i) and (ii) in Theorem 2.2. We will prove it by using an alternative method.

THEOREM 2.3. *Let $t_1 < t_2$ be two consecutive zeros of a nontrivial solution x of (0.1). Then any other solution of this equation which is not proportional to x has exactly one zero on (t_1, t_2) .*

PROOF. Among several possible methods of the proof we choose that one based on the Riccati substitution and the resulting equation (2.1). Let $w = r\Phi(x')/\Phi(x)$, then w is a solution of (2.1) which is defined on (t_1, t_2) and satisfies $w(t_1+) = \infty, w(t_2-) = -\infty$. Suppose that there exists a solution \tilde{x} of (0.1), linearly independent of x , which has no zero in (t_1, t_2) and let $\tilde{w} = r\Phi(\tilde{x}'/\tilde{x})$. Since $\tilde{x}(t_1) \neq 0, \tilde{x}(t_2) \neq 0$ (otherwise \tilde{x} would be a multiple of x), we have $\tilde{w}(t_1) < \infty, \tilde{w}(t_2) > -\infty$. Hence the graph of \tilde{w} has to intersect the graph of w at some point in (t_1, t_2) , but this contradicts the unique solvability of (2.1) (which follows from the fact that the function $c + (p - 1)r^{1-q}|w|^q$ is Lipschitzian with respect to w). \square

The Sturmian separation theorem also justifies the following definition of oscillation and nonoscillation of (0.1) which is the same as in the linear case. Equation (0.1) is said to be *nonoscillatory* (more precisely, nonoscillatory at ∞), if there exists $T_0 \in \mathbb{R}$ such that (0.1) is disconjugate on $[T_0, T_1]$ for every $T_1 > T_0$, in the opposite case (0.1) is said to be *oscillatory*.

According to Theorem 2.3, the above definition is correct, in the sense that oscillation of (0.1) means oscillation of its every nontrivial solution (i.e., the existence of a sequence of zeros of this solution tending to ∞). Note also that similarly to the linear case, if the functions r, c are continuous and $r(t) > 0$ in an interval $[T, \infty)$, then according to the unique solvability of the initial value problem associated with (0.1), the sequence of zeros of any nontrivial solution of (0.1) cannot have a finite cluster point.

Along with (0.1) consider another equation of the same form

$$(R(t)\Phi(y'))' + C(t)\Phi(y) = 0, \tag{2.13}$$

where the functions R, C satisfy the same assumptions as r, c , respectively, in (0.1).

The next statement is an extension of well-known Sturm comparison theorem to (0.1).

THEOREM 2.4. *Let $t_1 < t_2$ be consecutive zeros of a nontrivial solution x of (0.1) and suppose that*

$$C(t) \geq c(t), \quad r(t) \geq R(t) > 0 \tag{2.14}$$

for $t \in [t_1, t_2]$. Then any solution of (2.13) has a zero in (t_1, t_2) or it is a multiple of the solution x . The last possibility is excluded if one of the inequalities in (2.14) is strict on a set of positive measure.

PROOF. Let x be a solution of (0.1) having zeros at $t = t_1$ and $t = t_2$. Then by (2.12) we have $\mathcal{F}(x; t_1, t_2) = 0$ and according to (2.14)

$$\mathcal{F}_{RC}(x; t_1, t_2) := \int_{t_1}^{t_2} [R(t)|x'|^p - C(t)|x|^p] dt \leq 0. \tag{2.15}$$

This implies, by Theorem 2.2, that the solution y of (2.13) given by the initial condition $y(t_1) = 0, y'(t_1) > 0$ has a zero in (t_1, t_2) and by Theorem 2.3 any linearly independent solution of (2.13) has a zero in (t_1, t_2) . Finally, suppose that the first zero of y to the right of t_1 is just at t_2 , i.e., $y(t_1) = 0 = y(t_2)$. Let $v = R\Phi(y')/\Phi(y)$ be the solution of the Riccati equation associated with (2.13). Then, since $\lim_{t \rightarrow t_1+}[x(t)/y(t)] = \lim_{t \rightarrow t_1+}[x'(t)/y'(t)] = x'(t_1)/y'(t_1)$ exists finite, we have

$$\lim_{t \rightarrow t_1+} v(t)|x(t)|^p = \lim_{t \rightarrow t_1+} R(t)x(t)\Phi(y'(t))\frac{\Phi(x(t))}{\Phi(y(t))} = 0.$$

Similarly $\lim_{t \rightarrow t_2-} v(t)|x(t)|^p = 0$. This implies $\mathcal{F}_{RC}(x; t_1, t_2) \geq 0$ (in view of (2.7) with R, C, v instead of r, c, w respectively), but this contradicts to (2.15) since $\mathcal{F}_{RC}(x; t_1, t_2) < 0$ if one of inequalities in (2.14) is strict on an interval of positive length. \square

We will employ the same terminology as in the linear case. If (2.14) are satisfied in a given interval I , then (2.13) is said to be the *majorant* equation of (0.1) on I and (0.1) is said to be the *minorant* equation of (2.13) on I .

2.6. Transformation of independent variable

Let us introduce the new independent variable $s = \varphi(t)$ and the new function $y(s) = x(t)$, where φ is a differentiable function such that $\varphi'(t) \neq 0$ in some interval I where we consider Equation (0.1). Then $\frac{d}{dt} = \varphi'(t)\frac{d}{ds}$ and hence this transformation transforms (0.1) into the equation of the same form

$$\frac{d}{ds} \left[r(t)\Phi(\varphi'(t))\Phi\left(\frac{d}{ds}y\right) \right] + \frac{c(t)}{\varphi'(t)}\Phi(y) = 0, \quad t = \varphi^{-1}(s), \tag{2.16}$$

where φ^{-1} is the inverse function of φ . In particular, if

$$\varphi(t) = \int_T^t r^{1-q}(\tau) \, d\tau, \quad T \in I, \tag{2.17}$$

then the resulting equation (2.16) is the equation of the form (0.1) with $r(t) \equiv 1$.

Observe that if $\int^\infty r^{1-q}(t) \, dt = \infty$, then (2.17) transforms an unbounded interval $[T, \infty)$ into the interval $[0, \infty)$ which is of the same form as $[T, \infty)$. If $\int^\infty r^{1-q}(t) \, dt < \infty$ then the interval $[T, \infty)$ is transformed into the bounded interval $[0, b)$, $b = \int_T^\infty r^{1-q}(t) \, dt$. This fact, coupled with the remark about cluster points of an oscillatory solution of (0.1) given below Theorem 2.3, shows why some (non)oscillation criteria and asymptotic formulas for solutions of (0.1) substantially depend on the divergence (convergence) of $\int^\infty r^{1-q}(t) \, dt$.

2.7. Reciprocity principle

Suppose that the function c in (0.1) does not change its sign in an interval I and let $u = r\Phi(x')$. Then by a simple computation one can verify that u is a solution of the so-called *reciprocal equation*

$$(c^{1-q}(t)\Phi^{-1}(u'))' + r^{1-q}(t)\Phi^{-1}(u) = 0, \tag{2.18}$$

where $\Phi^{-1}(s) = |s|^{q-1} \operatorname{sgn} s$, $q = \frac{p}{p-1}$, is the inverse function of Φ . The terminology reciprocal equation is motivated by the linear case $p = 2$. The reciprocal equation to (2.18) is again the original equation (0.1)

If $t_1 < t_2$ are consecutive zeros of a solution x of (0.1), then by the Rolle mean value theorem u has at least one zero in (t_1, t_2) . Conversely, if $\tilde{t}_1 < \tilde{t}_2$ are consecutive zeros of u , then $u' = -c(t)x$ and hence also x has a zero in (t_1, t_2) . This means that (0.1) is oscillatory if and only if the reciprocal equation (2.18) is oscillatory. This fact we will refer to as the *reciprocity principle*.

2.8. Leighton–Wintner oscillation criterion

In this section we formulate a simple oscillation criterion for (0.1). Even if we will devote a special chapter to oscillation criteria for (0.1), we prefer to formulate this criterion already here. In the linear case $p = 2$, this criterion was proved first by Leighton [146] under the addition assumption $c(t) \geq 0$. This restriction was later removed by Wintner, see, e.g., [208].

THEOREM 2.5. *Equation (0.1) is oscillatory provided*

$$\int^\infty r^{1-q}(t) \, dt = \infty \quad \text{and} \quad \int^\infty c(t) \, dt = \lim_{b \rightarrow \infty} \int^b c(t) \, dt = \infty. \tag{2.19}$$

PROOF. According to the definition of oscillation of (0.1), we need to show that this equation is not disconjugate on any interval of the form $[T, \infty)$. To illustrate typical methods of the half-linear oscillation theory, we present here two different proofs.

(i) *Variational proof.* We will find, for every $T \in \mathbb{R}$, a nontrivial function $y \in W_0^{1,p}(T, \infty)$ such that

$$\mathcal{F}(y; T, \infty) = \int_T^\infty [r(t)|y'|^p - c(t)|y|^p] dt \leq 0. \tag{2.20}$$

The function which satisfies (2.20) can be constructed as follows

$$y(t) = \begin{cases} 0, & T \leq t \leq t_0, \\ \int_{t_0}^t r^{1-q}(s) ds \left(\int_{t_0}^{t_1} r^{1-q}(s) ds \right)^{-1}, & t_0 \leq t \leq t_1, \\ 1, & t_1 \leq t \leq t_2, \\ \int_t^{t_3} r^{1-q}(s) ds \left(\int_{t_2}^{t_3} r^{1-q}(s) ds \right)^{-1}, & t_2 \leq t \leq t_3, \\ 0, & t_3 \leq t < \infty, \end{cases}$$

where $T < t_0 < t_1 < t_2 < t_3$ will be specified later. Denote

$$K := \mathcal{F}(y; t_0, t_1) = \int_{t_0}^{t_1} [r(t)|y'|^p - c(t)|y|^p] dt.$$

Then by a direct computation we have

$$\mathcal{F}(y; T, \infty) = K - \int_{t_1}^{t_2} c(t) dt + \left(\int_{t_2}^{t_3} r^{1-q}(t) dt \right)^{-1} - \int_{t_2}^{t_3} c(t)|y|^p dt.$$

Since the function $g(t) = \int_t^{t_3} r^{1-q}(s) ds \left(\int_{t_2}^{t_3} r^{1-q}(s) ds \right)^{-1}$ is monotonically decreasing on $[t_2, t_3]$ with $g(t_2) = 1$ and $g(t_3) = 0$, by the second mean value theorem of integral calculus there exists $\xi \in (t_2, t_3)$ such that

$$\int_{t_2}^{t_3} c(t)g^p(t) dt = \int_{t_2}^{\xi} c(t) dt.$$

Using this equality, we have

$$\mathcal{F}(y; t_0, t_3) = K - \int_{t_1}^{\xi} c(t) dt + \left(\int_{t_2}^{t_3} r^{1-q}(t) dt \right)^{-1}.$$

Let $\varepsilon > 0$ and $t_1 > t_0$ be arbitrary. The second condition in (2.19) implies that t_2 can be chosen in such a way that $\int_{t_1}^{\xi} c(t) dt > K + \varepsilon$ and the first condition in (2.19) implies that $t_3 > t_2$ can be taken such that $\left(\int_{t_2}^{t_3} r^{1-q}(t) dt \right)^{-1} < \varepsilon$. Summarizing these estimates, we have

$$\mathcal{F}(y; t_0, t_3) \leq K - (K + \varepsilon) + \varepsilon \leq 0,$$

hence (0.1) is oscillatory by Theorem 2.2.

(ii) *Proof by the Riccati technique.* Suppose, by contradiction, that (2.19) holds and (0.1) is nonoscillatory. Then there exists $T \in \mathbb{R}$ and a solution w of Riccati equation (2.1) which is defined in the whole interval $[T, \infty)$. By integrating (2.1) from T to t we get

$$w(t) = w(T) - \int_T^t c(s) \, ds - (p-1) \int_T^t r^{1-q}(s) |w(s)|^q \, ds.$$

The second condition in (2.19) implies the existence of $T_1 > T$ such that we have $w(T) - \int_T^t c(s) \, ds \leq 0$ for $t > T_1$ and hence

$$w(t) \leq -(p-1) \int_T^t r^{1-q}(s) |w(s)|^q \, ds \quad \text{for } t > T_1.$$

Denote $G(t) = \int_T^t r^{1-q}(s) |w(s)|^q \, ds$, then $|w| = [G' r^{q-1}]^{1/q}$ and the last inequality reads

$$\frac{G'(t)}{G^q(t)} \geq (p-1)^q r^{1-q}(t).$$

By integrating this inequality from T_1 to t we get

$$\frac{1}{q-1} G^{1-q}(T_1) > \frac{1}{q-1} [G^{1-q}(T_1) - G^{1-q}(t)] \geq (p-1)^q \int_{T_1}^t r^{1-q}(s) \, ds.$$

Letting $t \rightarrow \infty$ we have a contradiction with the first condition in (2.19). \square

3. Differences between linear and half-linear equations

The basic difference between linear and half-linear equations has already been mentioned at the beginning of this chapter, it the fact that the solution space of (0.1) is only homogeneous but not additive. In this subsection we point out some other differences (some of them are more or less consequences of this lack of the additivity of the solution space).

3.1. Wronskian identity

If x_1, x_2 are two solutions of the *linear* Sturm–Liouville differential equation (1.1), then by a direct differentiation one can verify the so-called *Wronskian identity*

$$r(t)[x_1(t)x_2'(t) - x_1'(t)x_2(t)] \equiv \omega, \tag{3.1}$$

where ω is a real constant. We have no half-linear version of this identity. More precisely, the above identity (3.1) can be regarded as an identity $W(x_1, x_1', x_2, x_2') := r(x_1'x_2 - x_1x_2') = \omega$ along solutions x_1, x_2 of (1.1). Elbert [86] showed that for $p \neq 2$ there exists no function of 4 variables $W(x_1, x_2, x_3, x_4)$ which is constant along solutions of (0.1), with the properties:

- (i) W is continuously differentiable with respect to each variable.
- (ii) W is not identically constant on \mathbb{R}^4 .
- (iii) W has antisymmetry property $W(x_3, x_4, x_1, x_2) = -W(x_1, x_2, x_3, x_4)$.

This result was proved using the generalized Prüfer transformation, we refer to [86] for details. The absence of a Wronskian-type identity implies that we have also no analogue of the linear reduction of order formula: given a solution \tilde{x} of (1.1) with $\tilde{x}(t) \neq 0$ in an interval I , then

$$x(t) = \tilde{x}(t) \int^t \frac{ds}{r(s)\tilde{x}^2(s)}$$

is another solution of (1.1)

3.2. Transformation formula

Let $h(t) \neq 0$ be a differentiable function such that rh' is also differentiable and let us introduce a new dependent variable y which is related to the original variable x by the formula $x = h(t)y$. Then we have the following (linear) identity which is the basis of the linear transformation theory (see [5,32,183])

$$h(t)[(r(t)x')' + c(t)x] = (r(t)h^2(t)y')' + h(t)[(r(t)h'(t))' + c(t)h(t)]y. \quad (3.2)$$

In particular, if x a solution of (1.1) then y is a solution of

$$(R(t)y')' + C(t)y = 0$$

with $R = rh^2$ and $C = h[(rh')' + ch]$. Since the function Φ is not additive, we have no half-linear analogue of this transformation identity. This has the following important consequence. Many oscillation results for linear equation (1.1) are based on the so-called *trigonometric transformation* which reads as follows. Let x_1, x_2 be two (linearly independent) solutions of (1.1) such that $r(x_1x_2' - x_1'x_2) = 1$ and let $h = \sqrt{x_1^2 + x_2^2}$. Then we have the identity (which can be verified by a direct computation)

$$h[(rh')' + ch] = \frac{1}{rh^2}.$$

This means that the transformation $x = h(t)y$ transforms (1.1) into the equation

$$\left(\frac{1}{q(t)}y'\right)' + q(t)y = 0, \quad q(t) = \frac{1}{r(t)h^2(t)}. \quad (3.3)$$

Equation (3.3) can be solved explicitly and $y_1 = \sin(\int^t q(s) ds)$, $y_2 = \cos(\int^t q(s) ds)$ are its linearly independent solutions, in particular, (3.3) and hence also (1.1) is oscillatory if and only if

$$\int^{\infty} \frac{dt}{r(t)[x_1^2(t) + x_2^2(t)]} = \infty$$

for any pair of linearly independent solutions x_1, x_2 of (1.1). This fact is used in proofs of many oscillation results for (1.1), see [192,208] and references given therein. Since half-linear version of the transformation formula (3.2) is missing, analogous results for half-linear equation (0.1) are not known.

3.3. Fredholm alternative

Consider the linear Dirichlet boundary value problem associated with (1.1)

$$\begin{cases} (r(t)x')' + c(t)x = f(t), & t \in [a, b] \\ x(a) = 0 = x(b). \end{cases} \quad (3.4)$$

It is well known that if the homogeneous problem with $f(t) \equiv 0$ has only the trivial solution, then (3.4) has a solution for any (sufficiently regular) right-hand side f (the so-called *nonresonant case*). If the homogeneous problem has a solution φ_0 , problem (3.4) has a solution if and only if

$$\int_a^b f(t)\varphi_0(t) dt = 0.$$

In particular, the problem

$$x'' + x = f(t), \quad x(0) = 0 = x(\pi), \quad (3.5)$$

has a solution if and only if $\int_0^\pi f(t) \sin t dt = 0$.

Now consider the half-linear version of the boundary value problem (3.5)

$$\begin{cases} (\Phi(x'))' + (p-1)\Phi(x) = f(t), & t \in [a, b], \\ x(0) = 0 = x(\pi_p), \end{cases} \quad (3.6)$$

where the generalized π_p is given by (1.7). A natural question is whether

$$\int_0^{\pi_p} f(t) \sin_p t dt = 0 \quad (3.7)$$

is a necessary and sufficient condition for solvability of (3.6). This problem attracted considerable attention in last years, see [73] and the references given therein. It was shown that (3.7) is sufficient but no longer necessary for solvability of (3.6). We will deal with this problem in more details in the last chapter.

4. Some elementary half-linear equations

In this section we focus our attention to half-linear equations with constant coefficients and to Euler-type half-linear equation. The results presented here are essentially contained in the paper of Elbert [88]. This Elbert's paper deals with system (1.2) (with constant coefficients or coefficients corresponding to the generalized Euler equation), but results can be easily reformulated to equations of the form (0.1).

4.1. Equations with constant coefficients

Before passing to half-linear equations with constant coefficients, consider the equation

$$(r(t)\Phi(x'))' = 0. \quad (4.1)$$

The situation is here the same as in case of linear equations. The solution space of this equation is a two-dimensional linear space and the basis of this space is formed by the functions $x_1(t) \equiv 1$, $x_2(t) = \int^t r^{1-q}(s) ds$, where $q = \frac{p}{p-1}$ is the conjugate number of p .

Now, consider Equation (0.1) with $r(t) \equiv r > 0$ and $c(t) \equiv c$. This equation can be written in the form

$$(\Phi(x'))' + \frac{c}{r}\Phi(x) = 0 \quad (4.2)$$

and the transformation of independent variable $t \mapsto \lambda t$ with $\lambda = \left(\frac{|c|}{r^{p-1}}\right)^{1/p}$ transforms (4.2) into the equation

$$(\Phi(x'))' + (p-1) \operatorname{sgn} c \Phi(x) = 0$$

If $c > 0$, this equation already appeared in Section 1.3 as Equation (1.4). Its solution given (uniquely) by the initial condition $x(0) = 0$, $x'(0) = 1$ was denoted by $S = S(t)$ (or by $\sin_p t$) and it is called the *half-linear sine function*. The function $C(t) = S'(t)$ is called the *half-linear cosine function*. Consequently, taking into account homogeneity of the solution space of (0.1), we have the following statement concerning solvability of (1.4).

THEOREM 4.1. *For any $t_0 \in \mathbb{R}$, $x_0, x_1 \in \mathbb{R}$, the unique solution of (1.4) satisfying $x(t_0) = x_0$, $x'(t_0) = x_1$ is of the form $x(t) = \alpha S(t - t_1)$, where α, t_1 are real constants depending on t_0, x_0, x_1 .*

Now let $c < 0$, i.e., we consider the equation

$$(\Phi(x'))' - (p-1)\Phi(x) = 0. \quad (4.3)$$

Multiplying this equation by x' and integrating the obtained equation over $[0, t]$ we have the identity

$$|x'(t)|^p - |x(t)|^p = |x'(0)|^p - |x(0)|^p = C, \quad (4.4)$$

where C is a real constant. If $C = 0$ then $x' = \pm x$ thus $x_1 = e^t$ and $x_2 = e^{-t}$ are solutions of (4.3).

In the remaining part of this subsection we focus our attention to the generalized half-linear hyperbolic sine and cosine functions. In the linear case $p = 2$, these functions are linear combinations of e^t and e^{-t} . However, in the half-linear case the additivity of the solution space of (0.1) is lost and one has to use a more complicated method. Let $E = E_p(t)$ be the solution of (4.3) with the initial conditions $E(0) = 0, E'(0) = 1$, and similarly let $F = F_p(t)$ be the solution given by the initial conditions $F(0) = 1, F'(0) = 0$. Let us also observe that the function E corresponds to $C = 1$ and F to $C = -1$ in (4.4), respectively. Moreover, for $p = 2$, i.e., if differential equation (4.3) is linear, we have $E_2(t) = \sinh t$ and $F_2(t) = \cosh t$.

Due to (4.4), the function E satisfies also the relation

$$E' = \sqrt[p]{1 + |E|^p},$$

hence $E' > 1$ for $t > 0$. Consequently

$$t = \int_0^t \frac{E'(s) ds}{\sqrt[p]{1 + E^p(s)}} = \int_0^{E(t)} \frac{ds}{\sqrt[p]{1 + s^p}}. \tag{4.5}$$

In order to compare (asymptotically) the function $E(t)$ with e^t , let the function $f(s)$ be defined by

$$f(s) = \begin{cases} 1 & \text{for } 0 \leq s \leq 1, \\ \frac{1}{s} & \text{for } s \geq 1. \end{cases}$$

Then by (4.5) we obtain

$$t - \lg E(t) = 1 + \int_0^{E(t)} \frac{ds}{\sqrt[p]{1 + s^p}} - \int_0^{E(t)} f(s) ds \quad \text{for } E(t) > 1.$$

Hence

$$\lg \delta_p := \lim_{t \rightarrow \infty} [t - \lg E(t)] = 1 - \int_0^\infty \left[f(s) - \frac{1}{\sqrt[p]{1 + s^p}} \right] ds. \tag{4.6}$$

The integral in the right-hand side of (4.6) can be interpreted as the area of the domain on the (s, y) plane given by the inequalities

$$\frac{1}{\sqrt[p]{1 + s^p}} \leq y \leq f(s) \quad \text{for } 0 \leq s < \infty.$$

Taking y as an independent variable, we find for the integral in (4.6)

$$\lg \delta_p = 1 - \int_0^1 \frac{1 - \sqrt[p]{1 - y^p}}{y} dy = 1 - \frac{1}{p} \int_0^1 \frac{1 - u^{1/p}}{1 - u} du. \tag{4.7}$$

Since $0 < 1 - \sqrt[p]{1 - y^p} < y$ for $0 < y < 1$ we have $0 < \lg \delta_p < 1$, i.e., $1 < \delta_p < e$. On the other hand, the integral in (4.7) can be expressed by means of the function $\Psi(z) = d \lg \Gamma(z)/dz$ as

$$\Psi(z) = -\tilde{C} + \int_0^1 \frac{1 - t^{z-1}}{1 - t} dt \quad \text{for } \operatorname{Re} z > 0,$$

where \tilde{C} is the Euler constant and $\Gamma(z) = \int_0^\infty t^{z-1} e^{-t} dt$ denotes the usual Euler gamma function. Making use of this relation we obtain

$$\lg \delta_p = 1 - \frac{1}{p} \left[\tilde{C} + \Psi \left(\frac{p+1}{p} \right) \right]. \tag{4.8}$$

Finally, the relation (4.6) can be rewritten as

$$\lim_{t \rightarrow \infty} \frac{e^t}{E_p(t)} = \delta_p \quad \text{where } 1 < \delta_p < e. \tag{4.9}$$

A similar relation is expected also for the function $F_p(t)$. We will use the following auxiliary statement which we present without the proof, this proof can be found in [85].

LEMMA 4.1. *Let $I_1(R), I_2(R)$ be integrals defined by*

$$I_1(R) = \int_0^R \frac{d\xi}{\sqrt[p]{1 + \xi^p}}, \quad R > 0, \quad I_2(R) = \int_1^R \frac{d\xi}{\sqrt[p]{\xi^p - 1}}, \quad R > 1.$$

Then

$$\lim_{R \rightarrow \infty} [I_1(R) - I_2(R)] = \frac{\pi}{p} \cot \frac{\pi}{p}.$$

Now we return to the asymptotic formula for F_p . We want to obtain a relation similar to (4.9). Since F fulfills the differential equation

$$|F'|^p - |F|^p = -1,$$

we have

$$\frac{F'}{\sqrt[p]{F^p - 1}} = 1 \quad \text{for } t > 0.$$

Integrating the last equality yields

$$\int_1^{F(t)} \frac{d\xi}{\sqrt[p]{\xi^p - 1}} = t \quad \text{for } t > 0.$$

This relation implies that $\lim_{t \rightarrow \infty} F(t) = \infty$. On the other hand

$$\begin{aligned} \lim_{t \rightarrow \infty} [t - \lg F(t)] &= \lim_{t \rightarrow \infty} \int_1^{F(t)} \left[\frac{1}{\sqrt[p]{\xi^p - 1}} - f(\xi) \right] d\xi \\ &= \int_1^\infty \left[\frac{1}{\sqrt[p]{\xi^p - 1}} - \frac{1}{\xi} \right] d\xi \end{aligned} \tag{4.10}$$

because the integral on the right-hand side is convergent. Let Δ_p be introduced by

$$\lg \Delta_p := \int_1^\infty \left[\frac{1}{\sqrt[p]{\xi^p - 1}} - \frac{1}{\xi} \right] d\xi. \tag{4.11}$$

It is clear that $\Delta_p > 1$. The relation (4.10) can be rewritten as

$$\lim_{t \rightarrow \infty} \frac{e^t}{F_p(t)} = \Delta_p \quad \text{with } \Delta_p > 1. \tag{4.12}$$

Now we want to establish a connection between Δ_p and δ_p . By (4.6), (4.10), and taking into account the definition of the function $f(\xi)$, we have

$$\begin{aligned} \lg \frac{\Delta_p}{\delta_p} &= \lim_{R \rightarrow \infty} \left[\int_1^R \left(\frac{1}{\sqrt[p]{\xi^p - 1}} - \frac{1}{\xi} \right) d\xi - 1 + \int_0^R \left(f(\xi) - \frac{1}{\sqrt[p]{1 + \xi^p}} \right) d\xi \right] \\ &= \lim_{R \rightarrow \infty} [I_2(R) - I_1(R)], \end{aligned}$$

where the functions $I_1(R)$, $I_2(R)$ were introduced in Lemma 4.1. Then by this lemma we get the wanted relation as

$$\lg \frac{\delta_p}{\Delta_p} = \frac{\pi}{p} \cot \frac{\pi}{p}. \tag{4.13}$$

We may observe here that this relation implies that $\delta_2 = \Delta_2$ in the linear case ($p = 2$). In fact, we have $\delta_2 = 2 = \Delta_2$.

By (4.8) the value of δ_p can be considered to be known, consequently by the relation (4.13) the value of Δ_p is known as well.

Finally, there are interesting functional relations between the half-linear hyperbolic sine and cosine functions $E_p(t)$, $F_p(t)$ as follows

$$\begin{aligned} E'_p(t) &= \{F_q((p-1)t)\}^{q-1} = \Phi^{-1}(F_q((p-1)t)), \\ F'_p(t) &= \Phi^{-1}(E_q((p-1)t)). \end{aligned} \tag{4.14}$$

To prove these relations it is sufficient to show that the functions on both sides of the equalities satisfy the same differential equation and fulfill the same initial conditions, this is a matter of a direct computation (use, e.g., the result of Section 2.7).

The relations (4.14) provide another connections between the values of δ_p and Δ_p . Indeed, by (4.4) and (4.9) we have

$$\lim_{t \rightarrow \infty} \frac{E'_p(t)}{e^t} = \lim_{t \rightarrow \infty} \frac{E_p(t)}{e^t} = \frac{1}{\delta_p}. \quad (4.15)$$

On the other hand, this, (4.12) and (4.14) imply (taking into account that $(p-1)(q-1) = 1$ for conjugate pair p, q)

$$\frac{1}{\delta_p^{p-1}} = \lim_{t \rightarrow \infty} \frac{(E'_p(t))^{p-1}}{e^{(p-1)t}} = \lim_{t \rightarrow \infty} \frac{F_q((p-1)t)}{e^{(p-1)t}} = \frac{1}{\Delta_q}$$

hence

$$\Delta_q = \delta_p^{p-1}, \quad (4.16)$$

and similarly

$$\delta_q = \Delta_p^{p-1}. \quad (4.17)$$

We remark that the last two relations are equivalent since replacing p by q we get each from the other. By relations (4.13), (4.16) (or (4.17)) it is sufficient to know one of the values of $\Delta_p, \delta_p, \Delta_q, \delta_q$, and then all the other values can be obtained easily.

As in the linear case where the function $\sinh t$ is odd and the function $\cosh t$ is even, the functions $E_p(t), F_p(t)$ behave in a similar way:

$$E_p(-t) = -E_p(t), \quad F_p(-t) = F_p(t). \quad (4.18)$$

To prove this statement it is sufficient to show that the functions on the both side of the equality are solutions of differential equation (4.3) and satisfy the same initial conditions at $t = 0$. Then the uniqueness of the initial value problem (see Section 1.4) proves (4.18).

Now we know all the solutions of differential equations (4.3). We display them in the next theorem.

THEOREM 4.2. *The solutions of (4.3) are:*

$$K e^t, \quad K e^{-t}, \quad K E_p(t + t_0), \quad K F_p(t + t_0), \quad (4.19)$$

where K and t_0 are real parameters. More precisely, there are two one-parameter families of solutions $x(t) = K e^t$, $x(t) = K e^{-t}$ and two two-parameter families satisfying the following asymptotic formula

$$\lim_{t \rightarrow \infty} \frac{x(t)}{e^t} = L,$$

where $L = \frac{K e^{t_0}}{\delta_p}$ or $L = \frac{K e^{t_0}}{\Delta_p}$ with K from (4.19).

PROOF. Since Equation (4.3) is autonomous, it is sufficient to consider solutions whose initial values are prescribed at $t = 0$, i.e., $x(0) = x_0, x'(0) = x_1$. If $x_0 = 0 = x_1$, then according to the unique solvability $x(t) \equiv 0$. If at least one of the constants x_0, x_1 is nonzero, distinguish the cases according to the value of the constant C in (4.4). In case $C = 0$, the only possibilities are $x(t) = Ke^t$ or $x(t) = Ke^{-t}$. More precisely, if $x_0x_1 > 0$, then $x(t) = x_0e^t$, if $x_0x_1 < 0$, then $x(t) = x_0e^{-t}$. Now, if $C > 0$, then by the definition of the function E_p we have $x(t) = KE_p(t + t_0)$. Let $K = \text{sgn } x_0 \sqrt[p]{C}$. Since the function E_p is strictly increasing (observe that $E'(0) = 1, E'$ is continuous and $|E'|^p = 1 + |E|^p$) there exists $t_0 \in \mathbb{R}$ such that $CE_p(t_0) = x_1$. Concerning the initial condition for the derivative x' , we have

$$|x_1|^p = C + |x_0|^p = C + C|E|^p = C(1 + |E|^p) = C|E'|^p,$$

hence $x_1 = \pm KE'(t_0)$. But $E'(t_0) > 0$ and $\text{sgn } K = \text{sgn } x_1$, the sign $+$ is the correct one. If $C < 0$, let $K = \text{sgn } x_0 \sqrt[p]{-C}$ and t_0 be the solution of $CF'(t_0) = x_1$. Then the function $KF_p(t + t_0)$ is the solution we looked for.

Finally, concerning the asymptotic formula, any solution which is not proportional to e^t or e^{-t} satisfies by (4.9) or (4.12)

$$\lim_{t \rightarrow \infty} \frac{x(t)}{e^t} = \lim_{t \rightarrow \infty} \frac{KE(t + t_0)}{e^{t+t_0}} e^{t_0} = \frac{Ke^{t_0}}{\delta_p} \quad \text{or} \quad \lim_{t \rightarrow \infty} \frac{x(t)}{e^t} = \frac{Ke^{t_0}}{\Delta_p},$$

hence $L = \frac{Ke^{t_0}}{\delta_p}$ or $L = \frac{Ke^{t_0}}{\Delta_p}$. □

4.2. Euler-type half-linear differential equation

In this subsection we deal with the Euler-type differential equation

$$(\Phi(x'))' + \frac{\gamma}{t^p} \Phi(x) = 0, \tag{4.20}$$

where γ is a real constant. By the analogue with the linear Euler equation we look first for solutions in the form $x(t) = t^\lambda$. Substituting into (4.20) we get the algebraic equation for λ

$$G(\lambda) := (p - 1)|\lambda|^p - (p - 1)\Phi(\lambda) + \gamma = 0.$$

The function G is convex, hence the equation $G(\lambda) = 0$ has two, one or no (real) root according to the value of γ . However, even if the first possibility happens, since the additivity of the solution space of is lost in the half-linear case, we are not able to compute other solutions explicitly. To get a more detailed information about their asymptotic behavior, we use the procedure which is also typical in the linear case, namely the transformation of (4.20) into an equation with constant coefficients.

The change of independent variable $s = \lg t$ converts (4.20) into the equation (where the dependent variable will be denoted again by x and $' = \frac{d}{ds}$)

$$(\Phi(x'))' - (p - 1)\Phi(x') + \gamma\Phi(x) = 0. \tag{4.21}$$

The Riccati equation corresponding to (4.20) and (4.21) are

$$w' = -\gamma t^{-p} - (p - 1)|w|^p \tag{4.22}$$

and

$$v' = -\gamma + (p - 1)v - (p - 1)|v|^q =: F(v), \tag{4.23}$$

respectively. The solutions w and v are related by the formula $w(t) = t^{1-p}v(\lg t)$ and, moreover, we have $G(\Phi^{-1}(v)) = -F(v)$.

The function F is concave on \mathbb{R} with the global maximum at $\tilde{v} = (\frac{p-1}{p})^{p-1}$ and the value of this maximum is $\tilde{\gamma} = (\frac{p-1}{p})^p - \gamma$. We distinguish the following 3 cases with respect to the value of the constant γ .

- (I) $\gamma < \tilde{\gamma}$. Then the equation $F(v) = 0$ has two real roots $v_1 < \tilde{v} < v_2$;
- (II) $\gamma = \tilde{\gamma}$. Then the equation $F(v) = 0$ has the double root $v = \tilde{v}$;
- (III) $\gamma > \tilde{\gamma}$. Then $F(v) < 0$ for every $v \in \mathbb{R}$.

Case (I). The constant functions $v(s) \equiv v_1, v(s) \equiv v_2$ are solutions of (4.23). Clearly, if v is a solution of (4.23) such that $v(s) < v_1$, for some $s \in \mathbb{R}$, then $v'(s) < 0$, if $v(s) \in (v_1, v_2)$, then $v'(s) > 0$, and $v'(s) < 0$ for $v(s) > v_2$, a picture of the direction field of (4.23) helps to visualize the situation. Any solution of (4.23) different from $v(s) = v_{1,2}$ can be expressed (implicitly) in the form ($S \in \mathbb{R}$ being fixed)

$$\int_{v(S)}^{v(s)} \frac{dv}{F(v)} = s - S. \tag{4.24}$$

Observe that the integral $\int_{s_1}^{s_2} \frac{ds}{F(s)}$ is convergent whenever the integration interval does not contain zeros $v_{1,2}$ of F , in particular, for any $\varepsilon > 0$

$$\int_{-\infty}^{v_1-\varepsilon} \frac{dv}{F(v)} > -\infty, \quad \int_{v_2+\varepsilon}^{\infty} \frac{dv}{F(v)} > -\infty.$$

Case (Ia). $v(S) < v_1$; then $v(s) < v(S)$ for $s > S$ and v is decreasing. If v were extensible up to ∞ , we would have a contradiction with (4.24) since the right-hand side tends to ∞ while the left one is bounded. Later we will show that $v(s) = v_1$ is the so-called *eventually minimal solution* of (4.23).

Case (Ib). $v(S) \in (v_1, v_2)$; the solution v is increasing in this case, and as $s \rightarrow \infty$, we have $v(s) \rightarrow v_2$, otherwise we have the same contradiction as in the previous case.

Next we compute the asymptotic formula for the difference $v_2 - v(s)$. We have

$$F(v) = F'(v_2)(v - v_2) + O((v - v_2)^2), \quad \text{as } v \rightarrow v_2,$$

hence

$$\frac{1}{F(v)} = \frac{1}{F'(v_2)(v - v_2)[1 + O(v - v_2)]} = \frac{1}{F'(v_2)(v - v_2)} [1 + O(v - v_2)]$$

$$= \frac{1}{F'(v_2)(v - v_2)} + O(1)$$

and therefore (since $|v(s) - v(S)| < v_2 - v_1 = O(1)$), substituting into (4.24)

$$\int_{v(S)}^{v(s)} \frac{dv}{F(v)} = \frac{1}{F'(v_2)} \lg \frac{v_2 - v(s)}{v_2 - v(S)} + O(1) = s - S,$$

i.e.,

$$v_2 - v(s) = K \exp\{F'(v_2)s\},$$

where K is a positive constant (depending on $v(S)$), and substituting $w(t) = t^{1-p}v(\lg t)$ we have

$$v_2 - t^{p-1}w(t) = Kt^{F'(v_2)} \rightarrow 0 \quad \text{as } t \rightarrow \infty \tag{4.25}$$

since $F'(v_2) < 0$. Substituting $w = \frac{\Phi(x')}{\Phi(x)}$ in (4.25) we have

$$\frac{\Phi(x'(t))}{\Phi(x(t))} = t^{1-p}(v_2 - Kt^{F'(v_2)})$$

and using the formula $(1 + \alpha)^{p-1} = 1 + (p - 1)\alpha + o(\alpha)$ as $\alpha \rightarrow 0$, we obtain (with $q = \frac{p}{p-1}$)

$$\frac{x'(t)}{x(t)} = \frac{\Phi^{-1}(v_2)}{t} (1 - \tilde{K}t^{F'(v_2)})^{q-1} \sim \frac{\Phi^{-1}(v_2)}{t} (1 - \tilde{K}t^{F'(v_2)}),$$

as $t \rightarrow \infty$, here $f \sim g$ for a pair of functions f, g means $\lim_{t \rightarrow \infty} \frac{f(t)}{g(t)} = 1$, and \tilde{K} is a real constant. Thus

$$x(t) = t^{\lambda_2} \exp\{\bar{K}t^{F'(v_2)}\} \sim t^{\lambda_2} \quad \text{as } t \rightarrow \infty,$$

since $F'(v_2) < 0$, where \bar{K} is another real constant and $\lambda_2 = \Phi^{-1}(v_2)$ is the larger of roots of the equation $G(\lambda) = 0$.

Case (Ic). $v(S) > v_2$; then $v'(s) < 0$ and $v(s) \in (v_2, v(S))$ for $s > S$. Using the same argument as in (Ib) we have

$$t^{p-1}w(t) - v_2 = \tilde{K}t^{F'(v_2)} \rightarrow 0 \quad \text{as } t \rightarrow \infty,$$

\tilde{K} being a positive constant, and this implies the same asymptotic formula for the solution x of (4.20) which determines the solution w of (4.22).

Case (II). $\gamma = \tilde{\gamma} = (\frac{p-1}{p})^p$. Then the function F has the double root $\tilde{v} = (\frac{p-1}{p})^{p-1}$. Equation (4.20) has a solution $x(t) = t^{\Phi^{-1}(\tilde{v})} = t^{\frac{p-1}{p}}$. This means that (4.20) with $\gamma = \tilde{\gamma}$ is

still nonoscillatory. In the linear case $p = 2$, $\tilde{\gamma} = \frac{1}{4}$ and we are able to compute a linearly independent solution using the reduction of order formula. This solution is $\tilde{x}(t) = \sqrt{t} \lg t$. The reduction of order formula is missing in the half-linear case, but using essentially the same method as in Case (I) we are able to show that all solutions which are not proportional to $t^{\frac{p-1}{p}}$ behave asymptotically as $t^{\frac{p-1}{p}} \lg^{\frac{2}{p}} t$.

To this end, we proceed as follows. Since $F(\tilde{v}) = 0 = F'(\tilde{v})$,

$$F(v) = \frac{1}{2}F''(\tilde{v})(v - \tilde{v})^2 + O((v - \tilde{v})^3) \quad \text{as } v \rightarrow \tilde{v},$$

hence, taking into account that $F''(\tilde{v}) = -\frac{1}{\tilde{v}}$,

$$\begin{aligned} \frac{1}{F(v)} &= \frac{1}{\frac{1}{2}F''(\tilde{v})(v - \tilde{v})^2[1 + O(v - \tilde{v})]} \\ &= -\frac{2\tilde{v}}{(v - \tilde{v})^2} + O((v - \tilde{v})^{-1}) \quad \text{as } v \rightarrow \tilde{v}. \end{aligned}$$

On the other hand, using the same argument as in the previous part, we see from (4.24) that any solution v which starts with the initial value $v(S) < \tilde{v}$ fails to be extensible up to ∞ and solutions with $v(S) > \tilde{v}$ tend to \tilde{v} as $t \rightarrow \infty$. Substituting for $F(v)$ in (4.24) we have

$$\frac{2\tilde{v}}{v - \tilde{v}} + O(\lg |v - \tilde{v}|) = s - S,$$

hence

$$2\tilde{v} + (v - \tilde{v})O(\lg |v - \tilde{v}|) = (v - \tilde{v})(s - S).$$

Since $\lim_{v \rightarrow \tilde{v}} (v - \tilde{v})O(\lg |v - \tilde{v}|) = 0$, we have

$$\lim_{s \rightarrow \infty} (s - S)(v(s) - \tilde{v}) = \lim_{s \rightarrow \infty} s(v(s) - \tilde{v}) = 2\tilde{v}.$$

Consequently,

$$O(\lg |v(s) - \tilde{v}|) = O(\lg s^{-1}) = O(\lg s) \quad \text{as } s \rightarrow \infty,$$

and thus $(v(s) - \tilde{v})^{-1} = \frac{s}{2\tilde{v}} + O(\lg s)$, which means

$$v(s) - \tilde{v} = \frac{2\tilde{v}}{s} \frac{1}{1 + O(\frac{\lg s}{s})} = \frac{2\tilde{v}}{s} \left(1 + O\left(\frac{\lg s}{s}\right) \right) = \frac{2\tilde{v}}{s} + O\left(\frac{\lg s}{s^2}\right).$$

Now, taking into account that solutions of (4.22) and (4.23) are related by $w(t) = t^{1-p}v(\lg t)$, we have

$$t^{p-1}w(t) - \tilde{v} = \frac{2\tilde{v}}{\lg t} + O\left(\frac{\lg(\lg t)}{\lg^2 t}\right),$$

which means that the solution x of (4.20) which determines the solution w of (4.22) satisfies

$$\frac{x'(t)}{x(t)} \sim \frac{\Phi^{-1}(\tilde{v})}{t} \left(1 + \frac{2}{\lg t}\right)^{\frac{1}{p-1}} \sim \frac{p-1}{pt} + \frac{2}{pt \lg t}$$

and thus

$$x(t) \sim t^{\frac{p-1}{p}} \lg^{\frac{2}{p}} t.$$

Case (III). The equation $F(v) = 0$ has no real root and $F(v) < 0$ for every $v \in \mathbb{R}$. Again

$$\int_{v(S)}^{v(s)} \frac{dv}{F(v)} = s - S, \quad \text{and} \quad v(s) < v(S) \quad \text{for } s > S.$$

Since the left-hand side of the last equality is bounded for any value $v(s)$, while the right one tends to ∞ as $s \rightarrow \infty$, no solution of (4.23) and hence also of (4.22) is extensible up to ∞ , which means that (4.20) is oscillatory. We will show that oscillatory solutions of (4.21) are periodic and we will determine the value of their period.

To this end, we use the Prüfer transformation mentioned in Section 1 (compare also Remark 1.1 applied to (4.21)). Any nontrivial solution of this equation can be expressed in the form

$$x(s) = \rho(s)S(\varphi(s)), \quad x'(s) = \rho(s)S'(\varphi(s)),$$

where S is the generalized half-linear sine function. The angular and radial variables φ, ρ satisfy the first order differential system

$$\varphi' = |S'(\varphi)|^p - S(\varphi)\Phi(S'(\varphi)) + \frac{\gamma}{p-1}|S(\varphi)|^p, \tag{4.26}$$

$$\rho' = S'(\varphi) \left[\Phi(S'(\varphi)) + \left(1 - \frac{\gamma}{p-1}\right)\Phi(S(\varphi)) \right] \rho. \tag{4.27}$$

Oscillation of (4.21) implies that $\lim_{s \rightarrow \infty} \varphi(s) = \infty$. Denote

$$\Psi(\varphi) := |S'(\varphi)|^p - S(\varphi)\Phi(S'(\varphi)) + \frac{\gamma}{p-1}|S(\varphi)|^p. \tag{4.28}$$

Then

$$\int_{\varphi(S)}^{\varphi(s)} \frac{d\varphi}{\Psi(\varphi)} = s - S. \tag{4.29}$$

Here we have used the fact that $\Psi(\varphi) > 0$ for $\varphi \in \mathbb{R}$ since if $\varphi = 0 \pmod{\pi_p}$, then $\Psi(\varphi) = 1$ (observe that $|S(\varphi)|^p + |S'(\varphi)|^p = 1$), and if $S(\varphi) \neq 0$, then

$$\Psi(\varphi) = |S(\varphi)|^p \left[|\alpha|^p - \Phi(\alpha) + \frac{\gamma}{p-1} \right] > 0, \quad \alpha := \frac{S'(\varphi)}{S(\varphi)}.$$

Further, let

$$\tau = \int_0^{2\pi_p} \frac{d\varphi}{\Psi(\varphi)} = 2 \int_0^{\pi_p} \frac{d\varphi}{\Psi(\varphi)}. \tag{4.30}$$

By (4.28) we have $\Psi(\varphi + \pi_p) = \Psi(\varphi)$, hence $\varphi(s + \tau) = \varphi(s) + 2\pi_p$ and the substitution $t := \frac{S(\varphi)}{S'(\varphi)}$ gives

$$\tau = 2 \int_{-\infty}^{\infty} \frac{dt}{\frac{\gamma}{p-1}|t|^p - t + 1}, \tag{4.31}$$

which is the quantity depending only on γ .

Finally, we will estimate the radial variable ρ . Denote

$$R(\varphi) := S'(\varphi) \left[\Phi(S'(\varphi)) + \left(1 - \frac{\gamma}{p-1} \right) \Phi(S(\varphi)) \right].$$

By (4.27) and the identity $\varphi(s + \tau) = \varphi(s) + 2\pi_p$ we have

$$\lg \frac{\rho(s + \tau)}{\rho(s)} = \int_s^{s+\tau} R(\varphi(s)) ds = \int_{\varphi(s)}^{\varphi(s+\tau)} \frac{R(\varphi)}{\Psi(\varphi)} d\varphi = \int_0^{2\pi_p} \frac{R(\varphi)}{\Psi(\varphi)} d\varphi.$$

Now, using the identity $\Psi' + pR = p - 1$, we get

$$\lg \frac{\rho(s + \tau)}{\rho(s)} = \int_0^{2\pi_p} \frac{\frac{p}{p-1} - \frac{1}{p}\Psi'(\varphi)}{\Psi(\varphi)} d\varphi = \frac{p-1}{p}\tau = \frac{\tau}{q}. \tag{4.32}$$

A consequence of (4.32) is that the function $\rho(s) \exp\{-\frac{s}{q}\}$ is periodic with the period τ because of

$$\frac{\rho(s + \tau) \exp\{-\frac{s+\tau}{q}\}}{\rho(s) \exp\{-\frac{s}{q}\}} = \frac{\rho(s + \tau)}{\rho(s)} \exp\left\{-\frac{\tau}{q}\right\} = 1.$$

The previous computations in Case (III) are summarized in the next theorem.

THEOREM 4.3. *If $\gamma > \tilde{\gamma} = (\frac{p-1}{p})^p$ then Equation (4.21) is oscillatory and $x(s) = \rho(s) \exp\{-\frac{s}{q}\}$ is a periodic solution of (4.21) with the period τ given by (4.31).*

REMARK 4.1. Consider the half-linear differential equation

$$(t^\alpha \Phi(x'))' + \frac{\gamma}{t^{p-\alpha}} \Phi(x) = 0. \quad (4.33)$$

If $\alpha \neq p-1$ and we look for a solution of this equation in the form $x(t) = t^\lambda$, then substituting into (4.33) we get the algebraic equation for the exponent λ

$$(p-1)|\lambda|^p - (p-1-\alpha)\Phi(\lambda) + \gamma = 0. \quad (4.34)$$

This equation has a real root if and only if $\gamma \leq \tilde{\gamma}_\alpha := (\frac{|p-1-\alpha|}{p})^p$ and hence (4.33) with $\alpha \neq p-1$ is nonoscillatory if $\gamma \leq \tilde{\gamma}_\alpha$. If $\gamma > \tilde{\gamma}_\alpha$, using the same ideas as in case $\alpha = 0$ treated in main part of this section one can see that (4.33) is oscillatory.

If $\alpha = p-1$ and $\gamma > 0$, Equation (4.34) has no real root and in this case we consider the modified Euler-type equation

$$(t^{p-1} \Phi(x'))' + \frac{\gamma}{t \lg^p t} \Phi(x) = 0. \quad (4.35)$$

The change of independent variable $t \mapsto \lg t$ transforms (4.35) into Equation (4.20) and the interval $[1, \infty)$ is transformed into the interval $[e, \infty)$. The situation is summarized in the next theorem.

THEOREM 4.4. *If $\alpha \neq p-1$, Equation (4.33) is nonoscillatory if and only if*

$$\gamma \leq \left(\frac{|p-1-\alpha|}{p} \right)^p.$$

Equation (4.35) is nonoscillatory if and only if

$$\gamma \leq \left(\frac{p-1}{p} \right)^p.$$

4.3. Kneser-type oscillation and nonoscillation criteria

As an immediate consequence of the Sturmian comparison theorem and the above result concerning oscillation of Euler equation (4.20), we have the following half-linear version of the classical Kneser oscillation and nonoscillation criterion.

THEOREM 4.5. *Suppose that*

$$\liminf_{t \rightarrow \infty} t^p c(t) > \tilde{\gamma} = \left(\frac{p-1}{p} \right)^p. \quad (4.36)$$

Then the equation

$$(\Phi(x'))' + c(t)\Phi(x) = 0 \quad (4.37)$$

is oscillatory. If

$$\liminf_{t \rightarrow \infty} t^p c(t) < \tilde{\gamma}, \quad (4.38)$$

then (4.37) is nonoscillatory.

PROOF. If (4.36) holds, then $c(t) > \frac{\tilde{\gamma} + \varepsilon}{t^p}$ for some $\varepsilon > 0$ and since the Euler equation (4.20) with $\gamma = \tilde{\gamma} + \varepsilon$ is oscillatory, (4.37) is also oscillatory by the Sturm comparison theorem (Theorem 2.4). The nonoscillatory part of theorem can be proved using the same argument. \square

REMARK 4.2. Using the results of Theorem 4.4 and the Sturm comparison theorem, one can prove various extensions of the previous theorem. For example, if $\alpha \neq p - 1$,

$$\liminf_{t \rightarrow \infty} t^{-\alpha} r(t) > 1, \quad \limsup_{t \rightarrow \infty} t^{\alpha-p} c(t) < \tilde{\gamma}_\alpha$$

then (0.1) is nonoscillatory. An oscillation counterpart of this result, as well as the criteria in case $\alpha = p - 1$ can be formulated in a similar way.

This Page Intentionally Left Blank

Nonoscillatory Equations

In this chapter we concentrate our attention to nonoscillatory half-linear differential equations while oscillatory equations is the main concern of Chapter 3C. However, we formulate some oscillation criteria already here, mainly in situations when they are natural complements of their nonoscillation counterparts. First we present nonoscillation criteria for (0.1) which are based on the Riccati technique and the variational principle. Section 6 is devoted to the investigation of asymptotic properties of nonoscillatory solutions of (0.1). Then we deal with the important concept of the principal solution of nonoscillatory equation (0.1) and the last section of this chapter presents criteria for conjugacy and disconjugacy of (0.1) in a given interval.

Recall that (0.1) is said to be *nonoscillatory* if there exists $T \in \mathbb{R}$ such that (0.1) is disconjugate on $[T, \infty)$, i.e., every nontrivial solution of this equation has at most one zero in this interval and this means that every nontrivial solution is eventually positive or negative. Equation (0.1) is said to be *oscillatory* in the opposite case, i.e., when every nontrivial solution has infinitely many zeros tending to ∞ .

Note that from Theorem 2.2 or from Theorem 2.3 follows that this classification of half-linear equations is correct; all solution of (0.1) are either oscillatory or nonoscillatory.

5. Nonoscillation criteria

From the Roundabout theorem (Theorem 2.2) and also from the Sturmian comparison theorem (Theorem 2.4) it is easy to see that for nonoscillation of (0.1), the function c cannot be “too positive”, comparing with the positivity of the function r . The criteria of this section characterize in a quantitative way the vague expression “not too positive”.

The Roundabout theorem offers two basic methods of the investigation of oscillatory properties of (0.1). The first one, usually referred to as the *variational principle*, is based on the equivalence of disconjugacy of (0.1) and the positivity of the associated energy functional \mathcal{F} . The second main method—the *Riccati technique*—uses the equivalence of disconjugacy (0.1) and solvability of the generalized Riccati equation (2.1).

5.1. Variational principle and Wirtinger’s inequality

As an immediate consequence of the equivalence of (i) and (iv) in Theorem 2.2 we have the following statement which is used in the proofs of oscillation and nonoscillation criteria based on the variational principle.

THEOREM 5.1. *Equation (0.1) is nonoscillatory if and only if there exists $T \in \mathbb{R}$ such that*

$$\mathcal{F}(y; T, \infty) := \int_T^\infty [r(t)|y'|^p - c(t)|y|^p] dt > 0$$

for every nontrivial $y \in W_0^{1,p}(T, \infty)$.

A useful tool in the variational technique is the following half-linear version of the Wirtinger inequality.

LEMMA 5.1. *Let M be a positive continuously differentiable function for which $M'(t) \neq 0$ in $[a, b]$ and let $y \in W_0^{1,p}(a, b)$. Then*

$$\int_a^b |M'(t)||y|^p dt \leq p \int_a^b \frac{M^p(t)}{|M'(t)|^{p-1}} |y'|^p dt. \tag{5.1}$$

PROOF. Suppose that $M'(t) > 0$ in $[a, b]$, in the opposite case the proof is similar. Using integration by parts, the fact that y has a compact support in (a, b) , and the Hölder inequality, we have

$$\begin{aligned} \int_a^b |M'(t)||y|^p dt &\leq p \int_a^b M|y|^{p-1}|y'| dt \\ &\leq p \left(\int_a^b |M'||y|^{(p-1)q} dt \right)^{\frac{1}{q}} \left(\int_a^b \frac{M^p}{|M'|^{p-1}} |y'|^p dt \right)^{\frac{1}{p}} \\ &= p \left(\int_a^b |M'||y|^p dt \right)^{\frac{1}{q}} \left(\int_a^b \frac{M^p}{|M'|^{p-1}} |y'|^p dt \right)^{\frac{1}{p}}, \end{aligned}$$

hence (5.1) holds. □

5.2. Nonoscillation criteria via Wirtinger inequality

The Wirtinger inequality from the previous subsection is used in the next nonoscillation criterion.

THEOREM 5.2. *Denote $c_+(t) = \max\{0, c(t)\}$. If $\int^\infty r^{1-q}(t) dt = \infty$, $\int^\infty c_+(t) dt < \infty$, and*

$$\limsup_{t \rightarrow \infty} \left(\int^t r^{1-q}(s) ds \right)^{p-1} \left(\int_t^\infty c_+(s) ds \right) < \frac{1}{p} \left(\frac{p-1}{p} \right)^{p-1}, \tag{5.2}$$

or $\int^\infty r^{1-q}(t) dt < \infty$ and

$$\limsup_{t \rightarrow \infty} \left(\int_t^\infty r^{1-q}(s) ds \right)^{p-1} \left(\int^t c_+(s) ds \right) < \frac{1}{p} \left(\frac{p-1}{p} \right)^{p-1}, \tag{5.3}$$

then (0.1) is nonoscillatory.

PROOF. We will prove the statement in case $\int^\infty r^{1-q}(t) dt = \infty$. If this integral converges, the proof is analogous. Denote

$$\nu := \frac{1}{p} \left(\frac{p-1}{p} \right)^{p-1}, \quad M(t) := \left(\int^t r^{1-q}(s) ds \right)^{1-p}$$

and let $T \in \mathbb{R}$ be such that the expression in (5.2) is less than ν for $t > T$. Using (5.2), the Hölder inequality and the Wirtinger inequality, we have for any nontrivial $y \in W_0^{1,p}(T, \infty)$

$$\begin{aligned} \int_T^\infty c(t)|y|^p dt &\leq \int_T^\infty c_+(t)|y|^p dt = p \int_T^\infty c_+(t) \left(\int_T^t y' \Phi(y) ds \right) dt \\ &\leq p \int_T^\infty |y'| \Phi(y) M(t) \frac{\int_t^\infty c_+(s) ds}{M(t)} dt \\ &< p\nu \int_T^\infty M(t)|y'| |\Phi(y)| dt \\ &\leq p\nu \left(\int_T^\infty |M'(t)| |y|^p dt \right)^{\frac{1}{q}} \left(\int_T^\infty \frac{|M(t)|^p}{|M'(t)|^{p-1}} |y'|^p dt \right)^{\frac{1}{p}} \\ &\leq p^p \nu \int_T^\infty \frac{|M(t)|^p}{|M'(t)|^{p-1}} |y'|^p dt = \int_T^\infty r(t) |y'|^p dt \end{aligned}$$

since one may directly verify that

$$\frac{|M(t)|^p}{|M'(t)|^{p-1}} = (p-1)^{1-p} r(t).$$

Hence we have

$$\mathcal{F}(y; T, \infty) = \int_T^\infty [r(t)|y'|^p - c(t)|y|^p] dt > 0$$

for any nontrivial $y \in W_0^{1,p}(T, \infty)$. □

REMARK 5.1. (i) Later we will show that the constant $\frac{1}{p} \left(\frac{p-1}{p} \right)^{p-1}$ in the previous nonoscillation criterion is sharp in the sense that if the limit in (5.2) (or in (5.3)) is greater than this constant, then (0.1) is oscillatory. Also, when the previous criterion is applied to

Euler-type differential equation (4.20) in the previous chapter, we again reveal the critical constant $\tilde{\gamma} = \left(\frac{p-1}{p}\right)^p$.

(ii) In (5.2) and (5.3), the nonnegative part of the function c appeared. In the next subsection we present an improvement of the previous nonoscillation criterion, where instead of c_+ the function c directly appears.

(iii) If, in addition to assumptions of the previous theorem, we suppose that $c(t) > 0$ for large t then the second part of this theorem (the case when $\int^\infty r^{1-q}(t) dt < \infty$) can be deduced from the first one using the reciprocity principle from Section 2.7. Indeed, if (5.3) holds, then $\int^\infty c(t) dt = \infty$ and consider the reciprocal equation to (0.1)

$$(c^{1-q}(t)\Phi_q(u'))' + r^{1-q}(t)\Phi_q(u) = 0, \quad \Phi_q(u) = |u|^{q-1} \operatorname{sgn} u = \Phi^{-1}(u),$$

where q is again the conjugate number of p . This equation, with p replaced by q , r by c^{1-q} and c by r^{1-q} satisfies assumptions of the first part of Theorem 5.2, since (using $(p-1)(q-1) = 1$) $\int^\infty (c^{1-q}(t))^{1-p} dt = \int^\infty c(t) dt = \infty$ and

$$\begin{aligned} & \limsup_{t \rightarrow \infty} \left(\int^t c(s) ds \right)^{q-1} \left(\int_t^\infty r^{1-q}(s) ds \right) \\ &= \limsup_{t \rightarrow \infty} \left[\left(\int^t c(s) ds \right) \left(\int_t^\infty r^{1-q}(s) ds \right)^{p-1} \right]^{q-1} \\ &< \left[\frac{1}{p} \left(\frac{p-1}{p} \right)^{p-1} \right]^{q-1} = \frac{1}{q} \left(\frac{q-1}{q} \right)^{q-1} \end{aligned}$$

which is just the “reciprocal” counterpart of (5.2).

(iv) If $b = \infty$ and $M(t) = t$ in Lemma 5.1, we get the inequality

$$\int_a^\infty |y'|^p dt \geq \tilde{\gamma} \int_a^\infty \frac{|y|^p}{t^p} dt, \quad \tilde{\gamma} = \left(\frac{p-1}{p} \right)^p,$$

which is a Hardy-type inequality, see, e.g., [131]. This inequality has been extended in many directions and some of these extensions could be perhaps used to establish more sophisticated nonoscillation criteria than that given in Theorem 5.2. This problem is a subject of the present investigation.

5.3. Riccati inequality

From the Roundabout theorem (Theorem 2.2) it follows that nonoscillation of (0.1) is equivalent to solvability of the associated Riccati equation (2.1). Due to the Sturm comparison theorem, nonoscillation of (0.1) is actually equivalent to solvability of the Riccati inequality. This is formulated in the next statement.

THEOREM 5.3. *Equation (0.1) is nonoscillatory if and only if there exists a continuously differentiable function v defined on an interval $[T, \infty)$ and satisfying there the inequality*

$$v' + c(t) + (p - 1)r^{1-q}(t)|v|^q \leq 0. \tag{5.4}$$

PROOF. Let v be a solution of (5.4). Denote $C(t) := -v' - (p - 1)r^{1-q}(t)|v|^q$. Then v is a solution of $v' + C(t) + (p - 1)r^{1-q}(t)|v|^q = 0$ which is the Riccati equation associated with a Sturmian majorant of (0.1) (since $C(t) \geq c(t)$). This majorant equation is nonoscillatory and hence (0.1) is nonoscillatory as well. \square

The previous statement is used in the half-linear version of the classical Wintner criterion. This linear criterion claims that if $\int^\infty r^{-1}(t) dt = \infty$ and $\int^\infty c(t) dt$ converges, then the linear Sturm–Liouville equation (1.1) is nonoscillatory provided

$$\limsup_{t \rightarrow \infty} \left(\int^t r^{-1}(s) ds \right) \left(\int_t^\infty c(s) ds \right) < \frac{1}{4}$$

and

$$\liminf_{t \rightarrow \infty} \left(\int^t r^{-1}(s) ds \right) \left(\int_t^\infty c(s) ds \right) > -\frac{3}{4}.$$

The next half-linear extension of this linear criterion is proved in [60].

THEOREM 5.4. *Suppose that $\int^\infty r^{1-q}(t) dt = \infty$ and $\int^\infty c(t) dt = \lim_{b \rightarrow \infty} \int^b c(t) dt$ converges. If*

$$\limsup_{t \rightarrow \infty} \left(\int^t r^{1-q}(s) ds \right)^{p-1} \left(\int_t^\infty c(s) ds \right) < \frac{1}{p} \left(\frac{p-1}{p} \right)^{p-1}, \tag{5.5}$$

$$\liminf_{t \rightarrow \infty} \left(\int^t r^{1-q}(s) ds \right)^{p-1} \left(\int_t^\infty c(s) ds \right) > -\frac{2p-1}{p} \left(\frac{p-1}{p} \right)^{p-1}, \tag{5.6}$$

then (0.1) is nonoscillatory.

PROOF. We will find a solution of the Riccati type inequality

$$v' \leq -c(t) - (p - 1)r^{1-q}(t)|v|^q \tag{5.7}$$

which is extensible up to ∞ , i.e., it exists on some interval $[T, \infty)$. To find this solution v of (5.7), we show that there exists an extensible up to ∞ solution of the differential inequality

$$\rho' \leq (1 - p)r^{1-q}(t)|\rho + C(t)|^q, \quad C(t) := \int_t^\infty c(s) ds \tag{5.8}$$

related to (5.7) by the substitution $\rho = v - C$. This solution ρ is

$$\rho(t) = \beta \left(\int^t r^{1-q}(s) ds \right)^{1-p}, \quad \beta := \left(\frac{p-1}{p} \right)^p.$$

Indeed, $\rho' = (1-p)\beta r^{1-q}(t) \left(\int^t r^{1-q}(s) ds \right)^{-p}$ and the right-hand side of inequality (5.8) is

$$\begin{aligned} & (1-p)r^{1-q}(t) |\rho + C(t)|^q \\ &= (1-p)r^{1-q}(t) \left| \beta \left(\int^t r^{1-q} \right)^{1-p} + C(t) \right|^q \\ &= (1-p)r^{1-q}(t) \left| \beta + \left(\int^t r^{1-q} \right)^{p-1} C(t) \right|^q \left(\int^t r^{1-q} \right)^{(1-p)q} \\ &= (1-p)r^{1-q}(t) \left| \beta + \left(\int^t r^{1-q} \right)^{p-1} C(t) \right|^q \left(\int^t r^{1-q} \right)^{-p}. \end{aligned}$$

Consequently, (5.8) is equivalent to the inequality

$$\beta \geq \left| \beta + \left(\int^t r^{1-q} \right)^{p-1} C(t) \right|^q. \tag{5.9}$$

However, since (5.5) and (5.6) hold, there exists $\varepsilon > 0$ such that

$$-\frac{2p-1}{p} \left(\frac{p-1}{p} \right)^{p-1} + \varepsilon < \left(\int^t r^{1-q} \right)^{p-1} C(t) < \frac{1}{p} \left(\frac{p-1}{p} \right)^{p-1} - \varepsilon$$

for large t and by a direct computation it is not difficult to verify that (5.9) really holds. \square

If the integral $\int^\infty r^{1-q}(t) dt$ is convergent, the previous statement can be modified as follows.

THEOREM 5.5. *Suppose that $\int^\infty r^{1-q}(t) dt < \infty$. If*

$$\limsup_{t \rightarrow \infty} \left(\int_t^\infty r^{1-q}(s) ds \right)^{p-1} \left(\int^t c(s) ds \right) < \frac{1}{p} \left(\frac{p-1}{p} \right)^{p-1}$$

and

$$\liminf_{t \rightarrow \infty} \left(\int_t^\infty r^{1-q}(s) ds \right)^{p-1} \left(\int^t c(s) ds \right) > -\frac{2p-1}{p} \left(\frac{p-1}{p} \right)^{p-1},$$

then (0.1) is nonoscillatory.

PROOF. One can show in the same way as in the proof of Theorem 5.4 that the function

$$\rho(t) = -\left(\frac{p-1}{p}\right)^p \left(\int_t^\infty r^{1-q}(s) ds\right)^{1-p},$$

satisfies the inequality

$$\rho' \leq (1-p)r^{1-q}(t)|\rho - \tilde{C}(t)|^q, \quad \tilde{C}(t) = \int^t c(s) ds,$$

which implies that $v = \rho - \tilde{C}$ satisfies the Riccati inequality (5.4). □

5.4. Half-linear Hartman–Wintner theorem

The next theorem is a half-linear extension of the classical Hartman–Wintner theorem [106] which relates the square integrability of the solutions of the Riccati equation

$$w' + c(t) + w^2 = 0$$

corresponding to (1.1) with $r(t) \equiv 1$ to the finiteness of a certain limit involving the function c . The half-linear extension of this theorem (also in case $r(t) \equiv 1$) is proved in [153], but the modification of this proof to (0.1) as presented here is straightforward.

THEOREM 5.6. *Suppose that*

$$\int^\infty r^{1-q}(t) dt = \infty \tag{5.10}$$

and (0.1) is nonoscillatory. Then the following statements are equivalent.

(i) *It holds*

$$\int^\infty r^{1-q}(t)|w(t)|^q dt < \infty \tag{5.11}$$

for every solution w of (2.1).

(ii) *There exists a finite limit*

$$\lim_{t \rightarrow \infty} \frac{\int^t r^{1-q}(s) (\int^s c(\tau) d\tau) ds}{\int^t r^{1-q}(s) ds}. \tag{5.12}$$

(iii) *For the lower limit we have*

$$\liminf_{t \rightarrow \infty} \frac{\int^t r^{1-q}(s) (\int^s c(\tau) d\tau) ds}{\int^t r^{1-q}(s) ds} > -\infty. \tag{5.13}$$

PROOF. (i) \Rightarrow (ii): Nonoscillation of (0.1) implies that the Riccati equation (2.1) has a solution which is defined on an interval $[T, \infty)$. Integrating this equation from T to t and using (5.11) we have

$$\begin{aligned} w(t) &= w(T) - \int_T^t c(\tau) d\tau - (p-1) \int_T^t r^{1-q}(\tau) |w(\tau)|^q d\tau \\ &= w(T) - \int_T^t c(\tau) d\tau - (p-1) \int_T^\infty r^{1-q}(\tau) |w(\tau)|^q d\tau \\ &\quad + (p-1) \int_t^\infty r^{1-q}(\tau) |w(\tau)|^q d\tau \\ &= C - \int_T^t c(\tau) d\tau + (p-1) \int_t^\infty r^{1-q}(\tau) |w(\tau)|^q d\tau, \end{aligned} \quad (5.14)$$

where $C = w(T) + (p-1) \int_T^\infty r^{1-q}(\tau) |w(\tau)|^q d\tau$. Multiplying (5.14) by r^{1-q} and integrating the resulting equation from T to t , and then dividing by $\int_T^t r^{1-q}(s) ds$, we get

$$\begin{aligned} \frac{\int_T^t r^{1-q}(s) w(s) ds}{\int_T^t r^{1-q}(s) ds} &= C - \frac{\int_T^t r^{1-q}(s) (\int_T^s c(\tau) d\tau) ds}{\int_T^t r^{1-q}(\tau) d\tau} \\ &\quad + \frac{\int_T^t r^{1-q}(s) (\int_s^\infty r^{1-q}(\tau) |w(\tau)|^q d\tau) ds}{\int_T^t r^{1-q}(s) ds}. \end{aligned} \quad (5.15)$$

By the Hölder inequality we have

$$\begin{aligned} \left| \int_T^t r^{1-q}(s) w(s) ds \right| &= \left| \int_T^t r^{\frac{1-q}{p}}(s) r^{\frac{1-q}{q}}(s) w(s) ds \right| \\ &\leq \left(\int_T^t r^{1-q}(s) ds \right)^{\frac{1}{p}} \left(\int_T^t r^{1-q}(s) |w(s)|^q ds \right)^{\frac{1}{q}}, \end{aligned} \quad (5.16)$$

and hence, taking into account (5.11)

$$\begin{aligned} \left| \frac{\int_T^t r^{1-q}(s) w(s) ds}{\int_T^t r^{1-q}(s) ds} \right| &\leq \frac{(\int_T^t r^{1-q}(s) ds)^{\frac{1}{p}} (\int_T^t r^{1-q}(s) |w(s)|^q ds)^{\frac{1}{q}}}{\int_T^t r^{1-q}(s) ds} \\ &= \left(\frac{\int_T^t r^{1-q}(s) |w(s)|^q ds}{\int_T^t r^{1-q}(s) ds} \right)^{\frac{1}{q}} \rightarrow 0, \quad t \rightarrow \infty. \end{aligned}$$

Since also the last term in (5.15) tends to zero as $t \rightarrow \infty$ (again in view of (5.11)), we have that

$$\lim_{t \rightarrow \infty} \frac{\int_T^t r^{1-q}(s) \int_T^s c(\tau) d\tau}{\int_T^t r^{1-q}(s) ds} = C \quad \text{exists finite.}$$

(ii) \Rightarrow (iii): This implication is trivial.

(iii) \Rightarrow (i): Let w be any solution of (2.1) which exists on $[T, \infty)$. Then by (5.14) and using computation from the first part of this proof

$$\begin{aligned} \frac{\int_T^t r^{1-q}(s)w(s) ds}{\int_T^t r^{1-q}(s) ds} &= w(T) - \frac{\int_T^t r^{1-q}(s) \int_T^s c(\tau) d\tau}{\int_T^t r^{1-q}(\tau) d\tau} \\ &\quad - (p-1) \frac{\int_T^t r^{1-q}(s) (\int_T^t r^{1-q}(\tau) |w(\tau)|^q d\tau) ds}{\int_T^t r^{1-q}(s) ds}. \end{aligned}$$

Taking into account (5.13) and applying again the Hölder inequality, there exists a real constant K such that

$$\begin{aligned} &\frac{(\int_T^t r^{1-q}(s) |w(s)|^q ds)^{\frac{1}{q}}}{(\int_T^t r^{1-q}(s) ds)^{\frac{1}{q}}} \\ &\leq K - (p-1) \frac{\int_T^t r^{1-q}(s) (\int_T^s r^{1-q}(\tau) |w(\tau)|^q d\tau) ds}{\int_T^t r^{1-q}(s) ds}. \end{aligned}$$

Suppose that (5.11) fails to hold. Then by L'Hospital's rule the last term in the previous inequality tends to ∞ and hence

$$\left(\frac{\int_T^t r^{1-q}(s) |w(s)|^q ds}{\int_T^t r^{1-q}(s) ds} \right)^{\frac{1}{q}} \geq \frac{p-1}{p} \frac{\int_T^t r^{1-q}(s) (\int_T^s r^{1-q}(\tau) |w(\tau)|^q d\tau) ds}{\int_T^t r^{1-q}(s) ds}$$

for large t . Denote $S(t) = \int_T^t r^{1-q}(s) (\int_T^s r^{1-q}(\tau) |w(\tau)|^q d\tau) ds$. Then the last inequality reads

$$\left[\frac{S'(t)r^{q-1}(t)}{\int_T^t r^{1-q}(s) ds} \right]^{\frac{1}{q}} \geq \frac{1}{q} \frac{S(t)}{\int_T^t r^{1-q}(s) ds},$$

hence

$$\frac{S'(t)}{S^q(t)} \geq \left(\frac{1}{g} \right)^q \frac{r^{1-q}(t)}{(\int_T^t r^{1-q}(s) ds)^{q-1}}. \tag{5.17}$$

If $q \leq 2$, we integrate (5.17) from T_1 to t , $T_1 > T$, and we get

$$\begin{aligned} \frac{1}{q-1} S^{1-q}(T_1) &> \frac{1}{q-1} [S^{1-q}(T_1) - S^{1-q}(t)] \\ &\geq \left(\frac{1}{q}\right)^q \begin{cases} \lg\left(\int_T^t r^{1-q}(s) ds\right) & \text{if } q = 2, \\ \frac{1}{2-q} \left(\int_T^t r^{1-q}(s) ds\right)^{2-q} & \text{if } q < 2. \end{cases} \end{aligned}$$

Letting $t \rightarrow \infty$ we have a contradiction with the assumption that $\int^\infty r^{1-q}(t) dt = \infty$. If $q > 2$, we integrate (5.17) from t to ∞ and we obtain

$$\frac{1}{(q-1)S^{q-1}(t)} \geq \left(\frac{1}{q}\right)^q \frac{1}{(q-2)\left(\int^t r^{1-q}(s) ds\right)^{q-2}},$$

hence

$$\frac{q^q(q-2)}{q-1} \geq \left(\frac{S(t)}{\int^t r^{1-q}(s) ds}\right)^{q-1} \left(\int^t r^{1-q}(s) ds\right),$$

which is again a contradiction since $S(t)\left(\int^t r^{1-q}(s) ds\right)^{-1} \rightarrow \infty$ as $t \rightarrow \infty$. \square

As a direct consequence of the previous theorem we have the following oscillation criterion.

THEOREM 5.7. *Suppose that $\int^\infty r^{1-q}(t) dt = \infty$. Then each of the following two conditions is sufficient for oscillation of (0.1):*

$$\lim_{t \rightarrow \infty} \frac{\int^t r^{1-q}(s) \left(\int^s c(\tau) d\tau\right) ds}{\int^t r^{1-q}(s) ds} = \infty, \quad (5.18)$$

$$\begin{aligned} -\infty &< \liminf_{t \rightarrow \infty} \frac{\int^t r^{1-q}(s) \left(\int^s c(\tau) d\tau\right) ds}{\int^t r^{1-q}(s) ds} \\ &< \limsup_{t \rightarrow \infty} \frac{\int^t r^{1-q}(s) \left(\int^s c(\tau) d\tau\right) ds}{\int^t r^{1-q}(s) ds}. \end{aligned} \quad (5.19)$$

PROOF. We will prove sufficiency of (5.18) only, the proof of sufficiency of (5.19) is similar. Suppose that (0.1) is nonoscillatory and (5.18) holds. Then (5.13) holds and by the previous theorem the integral (5.11) converges for every solution w of (2.1) and hence limit (5.12) exists as a finite number which contradicts to (5.18). \square

5.5. Riccati integral equation and Hille–Wintner comparison theorem

The results of this subsection are taken essentially from the paper [136]. In that paper, it is supposed that $r(t) \equiv 1$ and $c(t) \geq 0$ for large t . However, the results as presented here can

be extended to (0.1) with r satisfying the below assumption (5.20), and without the sign restriction on the function c .

LEMMA 5.2. *Suppose that*

$$\int^{\infty} r^{1-q}(t) dt = \infty \tag{5.20}$$

and the integral $\int^{\infty} c(t) dt$ is convergent. Then (0.1) is nonoscillatory if and only if there exists a solution of the Riccati integral equation

$$w(t) = \int_t^{\infty} c(s) ds + (p - 1) \int_t^{\infty} r^{1-q}(s) |w(s)|^q ds. \tag{5.21}$$

PROOF. Suppose that (0.1) is nonoscillatory and let w be a solution of the associated Riccati equation (2.1) which is defined on some interval $[T_0, \infty)$. The convergence of the integral $\int^{\infty} c(t) dt$ and (5.20) imply that (5.11) holds by Theorem 5.6. Integrating (2.1) from t to T , $t \geq T_0$ and letting $T \rightarrow \infty$ we see that $\lim_{T \rightarrow \infty} w(T)$ exists and since (5.20) holds, this limit equals zero, i.e., w satisfies also (5.21). Conversely, if w is a solution of (5.21), then it is also a solution of (2.1) and hence (0.1) is nonoscillatory. \square

The previous lemma is used in the proof of the following half-linear extension of the Hille–Wintner comparison theorem. For its linear version see [208, Theorem 2.14].

THEOREM 5.8. *Together with (0.1) consider the equation*

$$(r(t)\Phi(y'))' + \tilde{c}(t)\Phi(y) = 0, \tag{5.22}$$

where r satisfies (5.20), \tilde{c} is continuous for large and $\int^{\infty} \tilde{c}(t) dt$ converges. If

$$0 \leq \int_t^{\infty} c(s) ds \leq \int_t^{\infty} \tilde{c}(s) ds \quad \text{for large } t \tag{5.23}$$

and (5.22) is nonoscillatory, then (0.1) is also nonoscillatory.

PROOF. We construct a solution w of (5.21). Nonoscillation of (5.22) implies the existence of a solution v of the associated integral equation

$$v(t) = \int_t^{\infty} \tilde{c}(s) ds + (p - 1) \int_t^{\infty} r^{1-q}(s) |v(s)|^q ds. \tag{5.24}$$

Let $T \in \mathbb{R}$ be such that (5.23) holds for $t \geq T$ and the solution v of (5.24) exists on $[T, \infty)$. Define the function set U and the mapping F by

$$U := \{u \in C[T, \infty): 0 \leq u(t) \leq v(t), t \geq T\}$$

and

$$(Fw)(t) = \int_t^\infty c(s) ds + (p - 1) \int_t^\infty r^{1-q}(s) |w(s)|^q ds, \quad t \geq T.$$

The set U is the convex and closed subset of the Fréchet space $C[T, \infty)$ with the topology of the uniform convergence on compact subintervals of $[T, \infty)$. It can be shown without difficulty that F maps U into itself, that F is continuous and that $F(U)$ is relatively compact subset of $C[T, \infty)$. Therefore, it follows from the Schauder–Tychonov fixed point theorem that there exists $w \in U$ such that $w = Fw$ and this function is by definition of F a solution of (5.21). □

5.6. Hille–Nehari criteria

In Section 4.2 we have shown that the Euler equation (4.20) is nonoscillatory if and only if $\gamma \leq \tilde{\gamma} = (\frac{p-1}{p})^p$. Consider now the equation

$$(r(t)\Phi(x'))' + \frac{\gamma r^{1-q}(t)}{(\int_t^\infty r^{1-q}(s) ds)^p} \Phi(x) = 0 \tag{5.25}$$

with r satisfying (5.20). The transformation of independent variable $t \mapsto \int^t r^{1-q}(s) ds$ transforms this equation into the Euler equation (4.20). Hence also (5.25) is nonoscillatory if and only if $\gamma \leq \tilde{\gamma}$. This fact, combined with Theorem 5.6, leads to the following nonoscillation and oscillation criteria which are the half-linear extension of the Hille–Nehari (non)oscillation criteria, see [208, Chapter II].

THEOREM 5.9. *Suppose that $\int^\infty r^{1-q}(t) dt = \infty$ and the integral $\int^\infty c(t) dt$ is convergent.*

(i) *If*

$$0 \leq \left(\int_t^t r^{1-q}(s) ds \right)^{p-1} \left(\int_t^\infty c(s) ds \right) \leq \frac{1}{p} \left(\frac{p-1}{p} \right)^{p-1}$$

for large t , then (0.1) is nonoscillatory.

(ii) *If*

$$\liminf_{t \rightarrow \infty} \left(\int_t^t r^{1-q}(s) ds \right)^{p-1} \left(\int_t^\infty c(s) ds \right) > \frac{1}{p} \left(\frac{p-1}{p} \right)^{p-1}, \tag{5.26}$$

then (0.1) is oscillatory.

PROOF. First of all observe that (5.26) implies that $\int_t^\infty c(s) ds > 0$ for large t . Now, since

$$\int_t^\infty \frac{\tilde{\gamma} r^{1-q}(s)}{(\int^s r^{1-q}(\tau) d\tau)^p} = \frac{1}{p} \left(\frac{p-1}{p} \right)^{p-1} \left(\int_t^t r^{1-q}(s) \right)^{1-p},$$

the statement follows from Theorem 5.8 with $\tilde{c}(t) = \tilde{\gamma}r^{1-q}(t)(\int^t r^{1-q}(s) ds)^{-p}$. □

5.7. Modified Hille–Nehari’s criteria

The results of this subsection are taken from [135]. It is supposed that $c(t) \geq 0$ for large t and that

$$\int^\infty r^{1-q}(t) dt < \infty. \tag{5.27}$$

We denote

$$\varrho(t) = \int_t^\infty r^{1-q}(s) ds.$$

The first auxiliary statement concerns boundedness of solutions of (0.1) and of the associated Riccati equation.

LEMMA 5.3. *Let x be a nonoscillatory solution of (0.1) and let $w = r\Phi(x')/\Phi(x)$ be the associated solution of (2.1). Then x and the function*

$$z(t) := \varrho^{p-1}w(t) \tag{5.28}$$

are bounded. Moreover,

$$\varrho^{p-1}(t)w(t) \geq -1 \quad \text{for large } t \tag{5.29}$$

and

$$\limsup_{t \rightarrow \infty} \varrho^{p-1}(t)w(t) \leq 0. \tag{5.30}$$

PROOF. Without loss of generality we can suppose that $x(t) > 0$ for $t \in [t_0, \infty)$. The function $r(t)\Phi(x')$ is nonincreasing (since its derivative equals $-c(t)\Phi(x) \leq 0$), the derivative x' is eventually of constant sign. That is, $x'(t) > 0$ for $t \geq t_0$ or there is $t_1 > t_0$ such that $x'(t) < 0$ for $t \geq t_1$, and that

$$r^{q-1}(s)x'(s) \leq r^{q-1}(t)x'(t) \quad \text{for } s \geq t \geq t_0.$$

Dividing this inequality by $r^{q-1}(s)$ and integrating it over $[t, \tau]$ gives

$$x(\tau) \leq x(t) + r^{q-1}(t)x'(t) \int_t^\tau r^{1-q}(s) ds. \tag{5.31}$$

If $x'(t) > 0$ for $t \geq t_0$, then we have from (5.31)

$$x(\tau) \leq x(t) + r^{q-1}(t)x'(t)\varrho(t)$$

which shows that x is bounded on $[t_0, \infty)$. If $x'(t) < 0$ for $t \geq t_1$, then x is clearly bounded and, letting $\tau \rightarrow \infty$ in (5.31) we have

$$0 \leq x(t) + r^{q-1}(t)x'(t)\varrho(t), \quad t \geq t_0.$$

In either case we obtain

$$\varrho(t)r^{q-1}(t)\frac{x'(t)}{x(t)} \geq -1,$$

which immediately implies (5.29).

The limit inequality (5.30) trivially holds if $x'(t) < 0$ for $t \geq t_1$, since in this case the function (5.28) itself is negative for $t \geq t_1$. If $x'(t) > 0$ for $t \geq t_0$, then there exist positive constants c_1, c_2 such that

$$x(t) \geq c_1 \quad \text{and} \quad r(t)\Phi(x'(t)) \leq c_2 \quad \text{for } t \geq t_0,$$

which implies

$$w(t) \leq \frac{c_2}{c_1^{p-1}}, \quad t \geq t_0.$$

Since $\varrho(t) \rightarrow 0$ as $t \rightarrow \infty$, we then conclude that

$$\lim_{t \rightarrow \infty} \varrho^{p-1}(t)w(t) = 0.$$

This completes the proof. □

Based on the previous lemma we show that nonoscillation of (0.1) is equivalent to solvability of a certain modified Riccati integral inequality.

THEOREM 5.10. *Equation (0.1) is nonoscillatory if and only if*

$$\int_t^\infty \varrho^p(s)c(s) \, ds < \infty \tag{5.32}$$

and there exists a continuous function v such that

$$\varrho^{p-1}v(t) \text{ is bounded,} \quad \varrho^{p-1}(t)v(t) \geq -1, \tag{5.33}$$

and

$$\begin{aligned} \varrho^p(t)v(t) \geq & \int_t^\infty \varrho^p(s)c(s) \, ds + p \int_t^\infty r^{1-q}(s)\varrho^{p-1}(s)v(s) \, ds \\ & + (p-1) \int_t^\infty r^{1-q}(s)\varrho^p(s)|v(s)|^q \, ds \end{aligned} \tag{5.34}$$

for large t .

PROOF. “ \Rightarrow ”: Let x be a solution of (0.1) such that $x(t) \neq 0$ for $t \geq t_0$ and let $w = r\Phi(x')/\Phi(x)$ be the corresponding solution of the Riccati equation (2.1). Multiplying this equation by $\rho^p(t)$ and integrating over $[t, \tau]$, $\tau \geq t \geq t_0$, we get

$$\begin{aligned} \rho^p(\tau)w(\tau) - \rho^p(t)w(t) &= -p \int_t^\tau r^{1-q}(s)\rho^{p-1}(s)w(s) \, ds - \int_t^\tau \rho^p(s)c(s) \, ds \\ &\quad - (p-1) \int_t^\tau r^{1-q}(s)\rho^p(s)|w(s)|^q \, ds. \end{aligned} \tag{5.35}$$

In view of boundedness of the function $\rho^{p-1}w(t)$ (compare the previous lemma), we see that $\rho^p(\tau)w(\tau) = \rho(\tau)\rho^{p-1}(\tau)w(\tau) \rightarrow 0$ as $\tau \rightarrow \infty$, and

$$\begin{aligned} \left| \int_t^\infty r^{1-q}(s)\rho^{p-1}(s)w(s) \, ds \right| &\leq \int_t^\infty r^{1-q}(s)|\rho^{p-1}(s)w(s)| \, ds < \infty, \\ \int_t^\infty r^{1-q}(s)\rho^p(s)|w(s)|^q \, ds &< \infty \end{aligned}$$

for $t \geq t_0$. Therefore, letting $\tau \rightarrow \infty$ in (5.35), we find that $\int_t^\infty \rho^p(s)c(s) \, ds$ is convergent, i.e., (5.32) holds, and

$$\begin{aligned} \rho^p(t)w(t) &= \int_t^\infty \rho^p(s)c(s) \, ds + p \int_t^\infty r^{1-q}(s)\rho^{p-1}(s)w(s) \, ds \\ &\quad + (p-1) \int_t^\infty r^{1-q}(s)\rho^p(s)|w(s)|^q \, ds \end{aligned}$$

hence (5.34) holds as equality. The inequality $\rho^p(t)w(t) \geq -1$ follows from the previous lemma.

“ \Leftarrow ”: Suppose that (5.32) holds and let w be a continuous function satisfying conditions of theorem. Further, let us denote $C[t_0, \infty)$ the Fréchet space of continuous functions with the topology of uniform convergence on compact subintervals of $[t_0, \infty)$. Consider the space

$$\mathcal{V} := \left\{ v \in C[t_0, \infty): -1 \leq v(t) \leq \rho^{p-1}(t)w(t), t \geq t_0 \right\}, \tag{5.36}$$

which is a closed convex subset of $C[t_0, \infty)$. Define the mapping $F : \mathcal{V} \rightarrow C[t_0, \infty)$ by

$$\begin{aligned} \rho(t)(Fv)(t) &= \int_t^\infty \rho^p(s)c(s) \, ds + p \int_t^\infty r^{1-q}(s)v(s) \, ds \\ &\quad + (p-1) \int_t^\infty r^{1-q}(s)|v(s)|^q \, ds. \end{aligned} \tag{5.37}$$

If $v \in \mathcal{V}$, then from (5.36), (5.37) and the inequality stated in theorem

$$(Fv)(t) \leq F(\rho^{p-1}w)(t) \leq \rho^{p-1}(t)w(t), \quad t \geq t_0,$$

and

$$\rho(t)[(Fv)(t) + 1] \geq \int_t^\infty r^{1-q}(s)[(p-1)|v(s)|^q + pv(s) + 1] ds \geq 0,$$

where we have used also the property that the function $(p-1)|\xi|^q + p\xi$ is strictly increasing for $\xi \geq -1$, i.e.,

$$(p-1)|\xi|^q + p\xi + 1 \geq 0, \quad \text{for } \xi \geq -1.$$

This shows that F maps \mathcal{V} into itself. It can be shown in a routine manner that F is continuous and $F(\mathcal{V})$ is relatively compact in the topology of $C[t_0, \infty)$. Therefore, by the Schauder–Tychonov fixed point theorem, there exists an element $v \in \mathcal{V}$ such that $v(t) = (Fv)(t)$. Define w by $w(t) = \frac{v(t)}{\rho^{p-1}(t)}$. Then, in view of (5.37), w satisfies the integral equation

$$\begin{aligned} \rho^p(t)w(t) &= \int_t^\infty \rho^p(s)c(s) ds + p \int_t^\infty r^{1-q}(s)\rho^{p-1}w(s) ds \\ &\quad + (p-1) \int_t^\infty r^{1-q}(s)\rho^p(s)|w(s)|^q ds. \end{aligned}$$

Differentiating this equality and then dividing by $\rho^p(t)$ shows that w solves Riccati equation (2.1) and hence (0.1) is nonoscillatory. \square

As an immediate consequence of the previous theorem we have the following oscillation criterion.

COROLLARY 5.1. *Equation (0.1) is oscillatory if*

$$\int^\infty c(s)\rho^p(t) dt = \infty. \tag{5.38}$$

This oscillation criterion opens a natural question about oscillatory nature of (0.1) when the integral in (5.38) is convergent. In answering this question a useful role is played by the following modification of the Hille–Wintner comparison theorem. Recall that we assume that $c(t) \geq 0$ for large t throughout this subsection.

THEOREM 5.11. *Consider the pair of Equations (0.1) and*

$$(r(t)\Phi(y'))' + \tilde{c}(t)\Phi(y) = 0, \tag{5.39}$$

where $\tilde{c}(t) \geq 0$, subject to the conditions

$$\int_t^\infty c(t)\rho^p(t) dt < \infty, \quad \int_t^\infty \tilde{c}(t)\rho^p(t) dt < \infty. \tag{5.40}$$

Suppose that

$$\int_t^\infty c(t)\rho^p(t) dt \leq \int_t^\infty \tilde{c}(t)\rho^p(t) dt. \tag{5.41}$$

Then nonoscillation of (5.39) implies that of (0.1), or equivalently, oscillation of (0.1) implies oscillation of (5.39).

PROOF. Assume that (5.39) is nonoscillatory. Then, by the part “only if” of Theorem 5.10 there exists a continuous function w satisfying (5.33) and

$$\begin{aligned} \rho^p(t)w(t) &\geq \int_t^\infty \rho^p(s)\tilde{c}(s) ds + p \int_t^\infty r^{1-q}(s)\rho^p(s)w(s) ds \\ &\quad + (p-1) \int_t^\infty r^{1-q}(s)\rho^p(s)|w(s)|^q ds. \end{aligned}$$

Using (5.40) and (5.41) we see that w satisfies the integral inequality (5.34) and hence (0.1) is nonoscillatory by the part “if” of Theorem 5.10. \square

In Remark 4.1 we have shown that the Euler-type half-linear differential equation (4.33) is nonoscillatory if and only if $\gamma < (\frac{|p-1-\alpha|}{p})^p$. The transformation of independent variable $u(s) = x(t)$, $s = s(t) = (\rho(t))^{\frac{p-1}{p-1-\alpha}}$, transforms (0.1) into the equation

$$(s^\alpha \Phi(u'))' + Q(s)\Phi(u) = 0, \tag{5.42}$$

where

$$Q(s) = \left(\frac{|\alpha - p + 1|}{p}\right)^p r^{1-q}(t(s))[\rho(t(s))]^{\frac{p-1}{\alpha-p+1}} c(t(s)),$$

$t = t(s)$ being the inverse function of $s = s(t)$. Now suppose that $\alpha > p - 1$. Then we have $\int_t^\infty s^{\alpha(1-q)} ds < \infty$, so (5.42) satisfies assumption (5.27). Comparing (5.42) with the Euler equation (4.33) (using Theorem 5.11) we have the following result which we present without proof.

THEOREM 5.12. *Suppose that (5.27) holds and the integral $\int_t^\infty \rho^p(t)c(t) dt$ is convergent.*

(i) *Equation (0.1) is oscillatory if*

$$\liminf_{t \rightarrow \infty} \rho^{-1}(t) \int_t^\infty c(s)\rho^p(s) ds > \left(\frac{p-1}{p}\right)^p.$$

(ii) Equation (0.1) is nonoscillatory if

$$\rho^{-1}(t) \int_t^\infty c(s) \rho^p(s) ds \leq \left(\frac{p-1}{p} \right)^p$$

for large t .

5.8. Comparison theorem with respect to p

Along with (0.1) we consider another half-linear equation with a different power function $\Phi_\alpha(x) = |x|^{\alpha-1} \operatorname{sgn} x$, $\alpha > 1$,

$$(r(t)\Phi_\alpha(x'))' + c(t)\Phi_\alpha(x) = 0, \quad (5.43)$$

we denote by β the conjugate number of α , i.e., $\beta = \frac{\beta}{\beta-1}$ (recall also that q is the conjugate number of p , i.e., $q = \frac{p}{p-1}$).

The main statement of this subsection gives a kind of comparison theorem with respect to the power of Φ . This statement is proved in [201] in a more general setting than presented here (in the scope of the so-called half-linear dynamic equations on time scales, compare Section 16.5 in the last chapter). However, we prefer here the formulation for (0.1) and (5.43).

THEOREM 5.13. *Let $r^{-\beta}(t) dt = \infty$, $\int^\infty c(t) dt$ converges and $\liminf_{t \rightarrow \infty} r(t) > 0$. If $\alpha \geq p$ and Equation (5.43) is nonoscillatory, then (0.1) is also nonoscillatory.*

PROOF. Denote $S(w, r, p) = (p-1)r^{-q}|w|^q$ (this is the third term in the Riccati equation (2.1)). Then S can be rewritten as

$$S(w, r, p) = (p-1)|w| \left(\frac{|w|^p}{r} \right)^{\frac{1}{p-1}}$$

and it is easy to compute that

$$\frac{\partial S}{\partial p}(w, r, p) = |w| \left(\frac{|w|}{r} \right)^{\frac{1}{p-1}} \left[1 - \lg \left(\frac{|w|}{r} \right)^{\frac{1}{p-1}} \right].$$

Hence, for $\frac{|w|}{r} \leq 1$ the function S is nondecreasing with respect to p .

Since (5.43) is nonoscillatory, by Lemma 5.2 there exists a function v satisfying the Riccati equation

$$v' + c(t) + S(v, r(t), \alpha) = 0,$$

and such that $v(t) \rightarrow 0$ as $t \rightarrow \infty$. Since $\liminf_{t \rightarrow \infty} r(t) > 0$, we have $\frac{|w(t)|}{r(t)} \leq 1$ for large t , and thus

$$0 = v' + c(t) + S(v, r(t), \alpha) \geq v'(t) + c(t) + S(v, r(t), p).$$

Hence (0.1) is nonoscillatory by Theorem 5.3. □

6. Asymptotic of nonoscillatory solutions

This section is devoted to the asymptotic properties of nonoscillatory solutions of Equation (0.1) when the function c does not change its sign. In this case it is possible associate with (0.1) its reciprocal equation

$$(c^{1-q}(t)\Phi^{-1}(u'))' + r^{1-q}(t)\Phi^{-1}(u) = 0. \tag{6.1}$$

Recall that the so-called reciprocity principle says that (6.1) is nonoscillatory if and only if (0.1) is nonoscillatory, see Section 2.7. Note also that if $c(t) \leq 0$ for large t then (0.1) is nonoscillatory since the equation $(r(t)\Phi(x'))' = 0$ is its nonoscillatory majorant.

6.1. Integral conditions and classification of solutions

If c is different from zero for large t , then all solutions of nonoscillatory equation (0.1) are eventually monotone, as the following result shows.

LEMMA 6.1. *Let $c(t) \neq 0$ for large t and x be a solution of nonoscillatory equation (0.1) defined on some interval (α_x, ∞) , $\alpha_x \geq 0$. Then either $x(t)x'(t) > 0$ or $x(t)x'(t) < 0$ for large t .*

PROOF. The monotonicity of x follows from the reciprocity principle which ensures that the so-called *quasiderivative* $x^{[1]} := r\Phi(x')$ does not change its sign for large t . □

Then it is possible, a priori, to divide the set of solutions of (0.1) into the following two classes:

$$\mathbb{M}^+ = \{x \text{ solution of (0.1): } \exists t_x \geq 0: x(t)x'(t) > 0 \text{ for } t > t_x\},$$

$$\mathbb{M}^- = \{x \text{ solution of (0.1): } \exists t_x \geq 0: x(t)x'(t) < 0 \text{ for } t > t_x\}.$$

Clearly, solutions in \mathbb{M}^+ are eventually either positive increasing or negative decreasing and solutions in \mathbb{M}^- are either positive decreasing or negative increasing. The existence of solutions in these classes depends on the sign of the function c , as the following results show.

PROPOSITION 6.1. *Assume $c(t) < 0$ for large t .*

- (i) Equation (0.1) has solutions in the class \mathbb{M}^- . More precisely, for every pair $(t_0, a) \in [0, \infty) \times \mathbb{R} \setminus \{0\}$ there exists a solution x of (0.1) in the class \mathbb{M}^- such that $x(t_0) = a$.
- (ii) Equation (0.1) has solutions in the class \mathbb{M}^+ . More precisely, for every pair $(a_0, a_1) \in \mathbb{R}^2$, $a_0 a_1 > 0$ and for any t_0 sufficiently large, there exists a solution x of (0.1) in the class \mathbb{M}^+ such that $x(t_0) = a_0$, $x'(t_0) = a_1$.

PROOF. Claim (i) follows, for instance, from [44, Theorem 1] and [178, Theorems 9.1, 9.2]. Concerning the claim (ii), let x be a solution of (0.1) such that $x(0)x'(0) > 0$. Since the auxiliary function

$$F_x(t) = r(t)\Phi(x'(t))x(t) \quad (6.2)$$

is nondecreasing, we obtain $x(t)x'(t) > 0$ for $t > 0$. The assertion follows taking into account that every solution is continuable up to ∞ , see Section 1. \square

In the opposite case, i.e., when $c(t) > 0$ for large t , the existence in the classes \mathbb{M}^+ , \mathbb{M}^- may be characterized by means of the convergence or divergence of the following two integrals

$$J_r = \int_0^\infty r^{1-q}(t) dt, \quad J_c = \int_0^\infty |c(t)| dt,$$

as the following results show.

LEMMA 6.2. Assume $c(t) > 0$ for large t .

- (i) If $J_c = \infty$, then $\mathbb{M}^+ = \emptyset$.
(ii) If $J_r = \infty$, then $\mathbb{M}^- = \emptyset$.

PROOF. (i) Let x be a solution of (0.1) in the class \mathbb{M}^+ and, without loss of generality, suppose $x(t) > 0$, $x'(t) > 0$ for $t \geq T \geq 0$. From (0.1) we obtain for $t \geq T$

$$r(t)\Phi(x'(t)) \leq r(T)\Phi(x'(T)) - \Phi(x(T)) \int_T^t c(s) ds$$

that gives a contradiction as $t \rightarrow \infty$. Claim (ii) follows by applying (i) to (6.1) and using the reciprocity principle. \square

PROPOSITION 6.2. Assume $c(t) > 0$ for large t .

- (i) If (0.1) is nonoscillatory and $J_r = \infty$, $J_c < \infty$, then $\mathbb{M}^+ \neq \emptyset$.
(ii) If (0.1) is nonoscillatory and $J_r < \infty$, $J_c = \infty$, then $\mathbb{M}^- \neq \emptyset$.
(iii) If $J_r < \infty$, $J_c < \infty$, then $\mathbb{M}^+ \neq \emptyset$, $\mathbb{M}^- \neq \emptyset$.

PROOF. Claims (i), (ii) follows from Lemma 6.2. The assertion (iii) follows, for instance, as a particular case from [218, Theorem 3.1, Theorem 3.3] and their proofs by choosing $R(t) = 1$ and observing that assumptions (3.2), (3.11) in [218] are not necessary in the half-linear case. \square

In view of Lemma 6.2, if (0.1) is nonoscillatory, c is eventually positive and $J_r + J_c = \infty$, then all the solutions of (0.1) belong to the same class (\mathbb{M}^+ or \mathbb{M}^-). In addition, from the same Lemma 6.2, the well-known Leighton-type oscillation result can be obtained: *Let c be eventually positive; if $J_r = J_c = \infty$, then (0.1) is oscillatory* (compare Theorem 2.5).

As in the quoted papers [38–41,45,176,181], in both cases $c > 0$ and $c < 0$ eventually, the classes $\mathbb{M}^+, \mathbb{M}^-$ may be divided, a priori, into the following four subclasses, which are mutually disjoint:

$$\mathbb{M}_B^- = \left\{ x \in \mathbb{M}^- : \lim_{t \rightarrow \infty} x(t) = \ell_x \neq 0 \right\},$$

$$\mathbb{M}_0^- = \left\{ x \in \mathbb{M}^- : \lim_{t \rightarrow \infty} x(t) = 0 \right\},$$

$$\mathbb{M}_B^+ = \left\{ x \in \mathbb{M}^+ : \lim_{t \rightarrow \infty} x(t) = \ell_x, |\ell_x| < \infty \right\},$$

$$\mathbb{M}_\infty^+ = \left\{ x \in \mathbb{M}^+ : \lim_{t \rightarrow \infty} |x(t)| = \infty \right\}.$$

In the following subsections we consider both cases $c(t) > 0, c(t) < 0$ and we describe the above classes in terms of certain integral conditions. Similarly to the linear case, we are going to show that the convergence or divergence of the two integrals

$$J_1 = \lim_{T \rightarrow \infty} \int_0^T r^{1-q}(t) \Phi^{-1} \left(\int_0^t |c(s)| ds \right) dt,$$

$$J_2 = \lim_{T \rightarrow \infty} \int_0^T r^{1-q}(t) \Phi^{-1} \left(\int_t^T |c(s)| ds \right) dt,$$

fully characterize the above four classes.

The following lemma describes relations between J_1, J_2, J_r, J_c .

LEMMA 6.3. *The following statements hold.*

- (a) *If $J_1 < \infty$, then $J_r < \infty$.*
- (b) *If $J_2 < \infty$, then $J_c < \infty$.*
- (c) *If $J_2 = \infty$, then $J_r = \infty$ or $J_c = \infty$.*
- (d) *If $J_1 = \infty$, then $J_r = \infty$ or $J_c = \infty$.*
- (e) *$J_1 < \infty$ and $J_2 < \infty$ if and only if $J_r < \infty$ and $J_c < \infty$.*

PROOF. Claim (a). Let $t_1 \in (0, T)$. Because

$$\begin{aligned} & \int_0^T r^{1-q}(s) \Phi^{-1} \left(\int_0^s |c(t)| dt \right) ds \\ & > \int_0^{t_1} r^{1-q}(s) \Phi^{-1} \left(\int_0^s |c(t)| dt \right) ds + \Phi^{-1} \left(\int_0^{t_1} |c(s)| ds \right) \int_{t_1}^T r^{1-q}(s) ds \end{aligned}$$

the assertion follows. Claim (b) follows in a similar way. Claims (c), (d) follow from the inequalities

$$\int_0^T r^{1-q}(t)\Phi^{-1}\left(\int_t^T |c(s)| ds\right) dt \leq \int_0^T r^{1-q}(t) dt \Phi^{-1}\left(\int_0^T |c(s)| ds\right),$$

$$\int_0^T r^{1-q}(t)\Phi^{-1}\left(\int_0^t |c(s)| ds\right) dt \leq \int_0^T r^{1-q}(t) dt \Phi^{-1}\left(\int_0^T |c(s)| ds\right).$$

Finally, the claim (e) immediately follows from (a)–(d). □

6.2. The case c negative

When the function $c(t)$ is eventually negative, the asymptotic properties of nonoscillatory solutions have been deeply studied and interesting contributions are due to the Georgian and Russian mathematical school [43,44,125,126,128,127,143,176,193]. Other recent developments can be found in [45,141,156,181]. Here we deal with some results that can be obtained, as a particular case, from recent criteria in [33,35] and, under the assumption that J_r is convergent or divergent, can be found in [180,210].

We start by noting that if $c(t) < 0$ in the whole interval $[0, \infty)$, then for any solution $x \in \mathbb{M}^-$ we have $x(t)x'(t) < 0$ on $[0, \infty)$. This property can be proved using the auxiliary function F_x given in (6.2). Since, as claimed, F is a nondecreasing function and x is not eventually constant, there are only two possibilities: (a) F_x does not have zeros; (b) there exists $t_x \geq \alpha_x$ such that $F_x(t) > 0$ for all $t > t_x$. Thus the assertion follows.

The following hold.

THEOREM 6.1. *Let $c(t) < 0$ for large t .*

- (i) *Equation (0.1) has solutions in the class \mathbb{M}_B^- if and only if $J_2 < \infty$.*
- (ii) *Equation (0.1) has solutions in the class \mathbb{M}_B^+ if and only if $J_1 < \infty$.*

PROOF. Claim (i) “ \Rightarrow ”: Let $x \in \mathbb{M}_B^-$. Without loss of generality we can assume $x(t) > 0$, $x'(t) < 0$ for $t \geq T \geq 0$. Integrating (0.1) in (t, ∞) , $t > T$, we obtain

$$-\lambda_x - r(t)\Phi(x'(t)) = \int_t^\infty |c(\tau)|\Phi_p(x(\tau)) d\tau, \tag{6.3}$$

where $-\lambda_x = \lim_{t \rightarrow \infty} [r(t)\Phi(x'(t))]$. Since $x(\tau) > x(\infty) > 0$ and $\lambda_x \geq 0$, (6.3) implies

$$-r(t)\Phi(x'(t)) \geq \Phi(x(\infty)) \int_t^\infty |c(\tau)| d\tau.$$

Hence

$$x(t) \leq x(T) - x(\infty) \int_T^t \Phi^{-1}\left(\frac{1}{r(s)} \int_s^\infty |c(\tau)| d\tau\right) ds.$$

As $t \rightarrow \infty$ we obtain the assertion.

Claim (i) “ \Leftarrow ”: Choose $t_0 \geq 0$ such that

$$\int_{t_0}^{\infty} \Phi^{-1} \left(\frac{1}{r(t)} \int_t^{\infty} |c(\tau)| \, d\tau \right) dt \leq \frac{1}{2}. \tag{6.4}$$

Denote by $C[t_0, \infty)$ the Fréchet space of all continuous functions on $[t_0, \infty)$ endowed with the topology of the uniform convergence on compact subintervals of $[t_0, \infty)$. Let Ω be the nonempty subset of $C[t_0, \infty)$ given by

$$\Omega = \left\{ u \in C[t_0, \infty) : \frac{1}{2} \leq u(t) \leq 1 \right\}. \tag{6.5}$$

Clearly Ω is bounded, closed and convex. Now consider the operator $T : \Omega \rightarrow C[t_0, \infty)$ which assigns to any $u \in \Omega$ the continuous function $T(u) = y_u$ given by

$$y_u(t) = T(u)(t) = \frac{1}{2} + \int_t^{\infty} \Phi^{-1} \left(\frac{1}{r(s)} \left(\int_s^{\infty} |c(\tau)| \Phi(u(\tau)) \, d\tau \right) \right) ds. \tag{6.6}$$

We have

$$\frac{1}{2} \leq T(u)(t) \leq \frac{1}{2} + \int_t^{\infty} \Phi^{-1} \left(\frac{1}{r(s)} \int_s^{\infty} |c(\tau)| \, d\tau \right) ds$$

which implies, by virtue of (6.4), $T(\Omega) \subseteq \Omega$. In order to apply the Tychonov fixed point theorem to operator T , it is sufficient to prove that T is continuous in $\Omega \subseteq C[t_0, \infty)$ and that $T(\Omega)$ is relatively compact in $C[t_0, \infty)$. Let $\{u_j\}$, $j \in \mathbb{N}$, be a sequence in Ω which is convergent to \bar{u} in $C[t_0, \infty)$, $\bar{u} \in \overline{\Omega} = \Omega$. Since for $s \geq t_0$

$$\Phi^{-1} \left(\frac{1}{r(s)} \left(\int_s^{\infty} |c(\tau)| \Phi(u_j(\tau)) \, d\tau \right) \right) \leq \Phi^{-1} \left(\frac{1}{r(s)} \left(\int_s^{\infty} |c(\tau)| \, d\tau \right) \right) < \infty,$$

the Lebesgue dominated convergence theorem gives the continuity of T in Ω . It remains to prove that $T(\Omega)$ is relatively compact in $C[t_0, \infty)$, i.e., that functions in $T(\Omega)$ are equibounded and equicontinuous on every compact subinterval of $[t_0, \infty)$. The equiboundedness easily follows taking into account that Ω is a bounded subset of $C[t_0, \infty)$. In order to prove the equicontinuity, for any $u \in \Omega$ we have

$$\begin{aligned} 0 < -(T(u)(t))' &= \Phi^{-1} \left(\frac{1}{r(t)} \left(\int_t^{\infty} |c(\tau)| \Phi(u(\tau)) \, d\tau \right) \right) \\ &\leq \Phi^{-1} \left(\frac{1}{r(t)} \left(\int_t^{\infty} |c(\tau)| \, d\tau \right) \right) \end{aligned} \tag{6.7}$$

which implies that functions in $T(\Omega)$ are equicontinuous on every compact subinterval of $[t_0, \infty)$. From the Tychonov fixed point theorem there exists $x \in \Omega$ such that $x = T(x)$ or, from (6.6),

$$x(t) = \frac{1}{2} + \int_t^\infty \Phi^{-1} \left(\frac{1}{r(s)} \left(\int_s^\infty |c(\tau)| \Phi(x(\tau)) \, d\tau \right) \right) \, ds.$$

It is easy to show that x is a positive solution of (0.1) in $[t_0, \infty)$ and, from (6.7), $x'(t) < 0$. Finally, clearly x satisfies the inequality $x(t)x'(t) < 0$ in its maximal interval of existence and the proof of claim (i) is complete.

Claim (ii) “ \Rightarrow ”: Assume, by contradiction, $J_1 = \infty$. Without loss of generality let x be a solution of (0.1) in the class \mathbb{M}_b^+ such that $x(t) > 0, x'(t) > 0$ for $t \geq t_0 \geq 0$. Integrating (0.1) on (t_0, t) we obtain for $t > t_0$

$$x^{[1]}(t) = x^{[1]}(t_0) + \int_{t_0}^t |c(s)| \Phi(x(s)) \, ds > \Phi_p(x(t_0)) \int_{t_0}^t |c(s)| \, ds,$$

where $x^{[1]} = r\Phi(x')$. Hence

$$x'(t) > x(t_0) \Phi^{-1} \left(\frac{1}{r(s)} \int_{t_0}^t |c(s)| \, ds \right).$$

Integrating again over (t_0, t) we obtain a contradiction.

Claim (ii) “ \Leftarrow ”: The argument is similar to that given in Claim (i) “ \Rightarrow ”. It is sufficient to consider in the same set Ω , defined in (6.5), the operator $T : \Omega \rightarrow C[t_0, \infty)$ given by

$$y_u(t) = T(u)(t) = \frac{1}{2} + \int_t^\infty \Phi^{-1} \left(\frac{1}{r(s)} \left(\int_{t_0}^s |c(\tau)| \Phi(u(\tau)) \, d\tau \right) \right) \, ds$$

and to apply the Tychonov fixed point theorem. □

THEOREM 6.2. *Let $c(t) < 0$ for large t .*

- (i) *If $J_1 = \infty$ and $J_2 < \infty$, then $\mathbb{M}_0^- = \emptyset$.*
- (ii) *If $J_1 < \infty$, then $\mathbb{M}_\infty^+ = \emptyset$.*

PROOF. Claim (i). Let x be a solution of (0.1) in the class \mathbb{M}^- such that $0 < x(t) < \varepsilon, x'(t) < 0$ for $t \geq T$ and $\lim_{t \rightarrow \infty} x(t) = 0$. By Lemma 6.3, $J_r = \infty$ and thus, by [33, Lemma 1], $\lim_{t \rightarrow \infty} r(t)\Phi(x'(t)) = 0$. Taking into account this fact and integrating (0.1) over $(t, \infty), t > T$, we obtain

$$\frac{x'(t)}{x(t)} > -\Phi^{-1} \left(\frac{1}{r(t)} \int_t^\infty |c(\tau)| \, d\tau \right).$$

Integrating over (T, t) we have

$$\lg \frac{x(t)}{x(T)} > - \int_T^t \Phi^{-1} \left(\frac{1}{r(s)} \int_s^\infty |c(\tau)| \, d\tau \right) \, ds,$$

from which, as $t \rightarrow \infty$, we obtain a contradiction.

Claim (ii). Let $x \in \mathbb{M}_\infty^+$ and assume $x(t) > 0, x'(t) > 0$ for $t \geq T \geq 0$. From (2.1) we have (with $w = r\Phi(x')/\Phi(x)$)

$$\begin{aligned} \frac{r(t)\Phi(x'(t))}{\Phi(x(t))} &= -(p-1) \int_T^t r^{1-q}(s)|w(s)|^q ds + k + \int_T^t |c(s)| ds \\ &\leq k + \int_T^t |c(s)| ds, \end{aligned} \tag{6.8}$$

where $k = r(T)\Phi(x'(T))/\Phi(x(T))$. If $J_c < \infty$, then there exists a positive constant k_1 such that

$$\frac{r(t)\Phi(x'(t))}{\Phi(x(t))} \leq k_1$$

or

$$\frac{x'(t)}{x(t)} \leq \Phi^{-1}(k_1)\Phi^{-1}\left(\frac{1}{r(t)}\right).$$

Integrating again over (T, t) we obtain

$$\lg \frac{x(t)}{x(T)} \leq \Phi^{-1}(k_1) \int_T^t r^{1-q}(s) ds$$

which implies $x \in \mathbb{M}_B^+$, i.e., a contradiction. If $J_c = \infty$, choose $t_1 > T$ such that $k < \int_T^{t_1} c(s) ds$. Then from (6.8) we obtain for $t \geq t_1$

$$\frac{r(t)\Phi(x'(t))}{\Phi(x(t))} \leq 2 \int_T^t |c(s)| ds,$$

or

$$\frac{x'(t)}{x(t)} \leq \Phi^{-1}(2)\Phi^{-1}\left(\frac{1}{r(t)} \int_T^t |c(s)| ds\right).$$

Integrating over (t_1, t) we have

$$\lg \frac{x(t)}{x(t_1)} \leq \Phi^{-1}(2) \int_T^t \Phi^{-1}\left(\frac{1}{r(s)} \int_T^s |c(\tau)| d\tau\right) ds$$

which gives the assertion. □

THEOREM 6.3. *Let $c(t) < 0$ for large t . If $J_1 < \infty$ and $J_2 < \infty$, then Equation (0.1) has solutions in both classes \mathbb{M}_0^- and \mathbb{M}_B^- .*

PROOF. The statement $\mathbb{M}_B^- \neq \emptyset$ follows from Theorem 6.1. The existence in the class \mathbb{M}_0^- can be proved by using a similar argument as that given in the proof of Theorem 6.1. It is sufficient to consider the set

$$\Omega = \left\{ u \in C[t_0, \infty) : 0 \leq u(t) \leq \int_t^\infty r^{1-q}(s) ds \right\}$$

and the operator $T : \Omega \rightarrow C[t_0, \infty)$ given by

$$y_u(t) = T(u)(t) = \int_t^\infty r^{1-q}(t) \Phi^{-1} \left(1 - \int_{t_0}^s |c(\tau)| \Phi(u(\tau)) d\tau \right) ds$$

and to apply the Tychonov fixed point theorem, details are omitted. □

REMARK 6.1. The behavior of quasiderivatives of solutions (i.e., of expressions $x^{[1]} = r\Phi(x')$) plays an important role in the study of principal solutions, especially in their limit characterization, see the next section. Concerning the solution $x \in \mathbb{M}_B^-$, defined as a fixed point in the proof of Theorem 6.1, we have $\lim_{t \rightarrow \infty} x^{[1]}(t) = 0$. Concerning the solution $x \in \mathbb{M}_0^-$, defined in the proof of Theorem 6.3, it is easy to show that $\lim_{t \rightarrow \infty} x^{[1]}(t) = c_x < 0$. Indeed, the limit

$$\lim_{t \rightarrow \infty} x'(t)r^{q-1}(t) \tag{6.9}$$

exists finite and it is different from zero, because

$$\begin{aligned} -x'(t) &= r^{1-q}(t) \Phi^{-1} \left(1 - \int_{t_0}^t |c(\tau)| \Phi(u(\tau)) d\tau \right) \geq \Phi^{-1} \left(\frac{1}{2} \right) \Phi^{-1} \left(\frac{1}{r(t)} \right) \\ &= 2^{1-q} r^{1-q}(t). \end{aligned}$$

and the function $x'r^{q-1}$ is negative increasing.

From Theorems 6.1, 6.2, 6.3, we can summarize the situation in the following way. Clearly, as regards the convergence or divergence of J_1, J_2 , the possible cases are the following:

- (A₁): $J_1 = \infty, J_2 = \infty,$
- (A₂): $J_1 = \infty, J_2 < \infty,$
- (A₃): $J_1 < \infty, J_2 = \infty,$
- (A₄): $J_1 < \infty, J_2 < \infty.$

Then the following result holds.

THEOREM 6.4. *Let $c(t) < 0$ for large t .*

- (i) *Assume case (A₁). Then any solution of (0.1) in the class \mathbb{M}^- tends to zero as $t \rightarrow \infty$ and any solution of (0.1) in the class \mathbb{M}^+ is unbounded.*

- (ii) Assume case (A₂). Then any solution of (0.1) in the class \mathbb{M}^- tends to a nonzero limit as $t \rightarrow \infty$ and any solution of (0.1) in the class \mathbb{M}^+ is unbounded.
- (iii) Assume case (A₃). Then any solution of (0.1) in the class \mathbb{M}^- tends to zero as $t \rightarrow \infty$ and any solution of (0.1) in the class \mathbb{M}^+ is bounded.
- (iv) Assume case (A₄). Then both solutions of (0.1) converging to zero and solutions of (0.1) tending to a nonzero limit (as $t \rightarrow \infty$) exist in the class \mathbb{M}^- . Further solutions of (0.1) in the class \mathbb{M}^+ are bounded.

From Theorem 6.4 we obtain immediately the following result which generalizes a well-know one stated for the linear equation in [173, Theorems 3 and 4]; see also [106, Chapters VI, XI]).

COROLLARY 6.1. *Let $c(t) < 0$ for large t .*

- (a) *Any solution x of (0.1) in the class \mathbb{M}^- tends to zero as $t \rightarrow \infty$ if and only if $J_2 = \infty$.*
- (b) *Any solution of (0.1) is bounded if and only if $J_1 < \infty$.*

Following another classification used in [180,210], we distinguish these types of eventually positive solutions x of (0.1) (clearly a similar classification holds for eventually negative solutions):

Type (1)	$\lim_{t \rightarrow \infty} x(t) = 0,$	$\lim_{t \rightarrow \infty} x^{[1]}(t) = 0;$
Type (2)	$\lim_{t \rightarrow \infty} x(t) = 0,$	$\lim_{t \rightarrow \infty} x^{[1]}(t) = c_1 < 0;$
Type (3)	$\lim_{t \rightarrow \infty} x(t) = c_0 > 0,$	$\lim_{t \rightarrow \infty} x^{[1]}(t) = c_1 \leq 0;$
Type (4)	$\lim_{t \rightarrow \infty} x(t) = c_0 > 0,$	$\lim_{t \rightarrow \infty} x^{[1]}(t) = c_1 > 0;$
Type (5)	$\lim_{t \rightarrow \infty} x(t) = c_0 > 0,$	$\lim_{t \rightarrow \infty} x^{[1]}(t) = \infty;$
Type (6)	$\lim_{t \rightarrow \infty} x(t) = \infty,$	$\lim_{t \rightarrow \infty} x^{[1]}(t) = c_1;$
Type (7)	$\lim_{t \rightarrow \infty} x(t) = \infty,$	$\lim_{t \rightarrow \infty} x^{[1]}(t) = \infty.$

Eventually positive solutions in \mathbb{M}^- are of the Types (1)–(3), eventually positive solutions in \mathbb{M}^+ are of the Types (4)–(7). From Theorem 6.4 and the reciprocity principle (see Section 2.7), necessary and/or sufficient conditions for their existence can be obtained. To this end observe that the integral $J_r [J_c]$ for (0.1) plays the same role as $J_c [J_r]$ for the reciprocal equation (6.1). Similarly, for the reciprocal equation (6.1) the integrals J_1, J_2 becomes

$$R_1 = \lim_{T \rightarrow \infty} \int_0^T |c(t)| \Phi \left(\int_0^t r^{1-q}(s) ds \right) dt$$

$$R_2 = \lim_{T \rightarrow \infty} \int_0^T |c(t)| \Phi \left(\int_t^T r^{1-q}(s) ds \right) dt,$$

respectively. Then the following holds.

THEOREM 6.5. *Let $c(t) < 0$ for large t . Then the following statements hold:*

- (a) *Every eventually positive solution in \mathbb{M}^- is of Type (1) if and only if $J_2 = \infty$ and $R_2 = \infty$.*
- (b) *Equation (0.1) has solutions of Type (2) if and only if $R_2 < \infty$.*
- (c) *Equation (0.1) has solutions of Type (3) if and only if $J_2 < \infty$.*
- (d) *Equation (0.1) has solutions of Type (4) if and only if $J_1 < \infty$ and $R_1 < \infty$.*
- (e) *Equation (0.1) has solutions of Type (5) if and only if $J_1 < \infty$ and $R_1 = \infty$.*
- (f) *Equation (0.1) has solutions of Type (6) if and only if $J_1 = \infty$ and $R_1 < \infty$.*
- (g) *Every eventually positive solution in \mathbb{M}^+ is of Type (7) if and only if $J_1 = \infty$ and $R_1 = \infty$.*

6.3. Uniqueness in \mathbb{M}^- .

The uniqueness in the class \mathbb{M}^- plays a crucial role in the study of the limit characterization of principal solutions (see Theorem 7.6 in the next section).

Proposition 6.1 states that, when c is eventually negative, the class \mathbb{M}^- is nonempty. In the linear case, the assumption

$$\int_0^\infty \left(\frac{1}{r(t)} + |c(t)| \right) dt = \infty \tag{6.10}$$

is necessary and sufficient for uniqueness in \mathbb{M}^- of such a solution, when the initial value of the solution is given (see [173, Theorems 3,4]). We will show that also for (0.1) such a property is assured by a natural extension of condition (6.10).

THEOREM 6.6. *Let $c(t) < 0$ for large t . For any $(t_0, x_0) \in [0, \infty) \times \mathbb{R} \setminus \{0\}$, there exists a unique solution x of (0.1) in the class \mathbb{M}^- such that $x(t_0) = x_0$ if and only if*

$$\int_0^\infty (r^{1-q}(t) + |c(t)|) dt = \infty. \tag{6.11}$$

The following result can be easily proved and will be useful in the proof of Theorem 6.6.

LEMMA 6.4. *Let $c(t) < 0$ for large t . If $J_r = \infty$, then for every solution x of (0.1) in the class \mathbb{M}^- we have $\lim_{t \rightarrow \infty} x^{[1]}(t) = 0$.*

PROOF OF THEOREM 6.6. *Necessity.* Assume (6.11) does not hold, i.e.,

$$\int_0^\infty |c(\tau)| d\tau < \infty, \quad \int_0^\infty r^{1-q}(t) dt < \infty,$$

and let t_0 be large such that

$$\Phi^{-1} \left(\int_{t_0}^\infty |c(\tau)| d\tau \right) \int_{t_0}^\infty \Phi^{-1} \left(\frac{1}{r(t)} \right) dt < \frac{1}{\Phi^{-1}(2)}. \tag{6.12}$$

Consider the solutions x_1, x_2 of (0.1) with the initial values $x_1(t_0) = x_2(t_0) = 1$ and

$$\begin{aligned} x_1'(t_0) &= -\Phi^{-1}\left(\frac{c_1}{r(t_0)} \int_{t_0}^{\infty} |c(\tau)| d\tau\right), \\ x_2'(t_0) &= -\Phi^{-1}\left(\frac{c_2}{r(t_0)} \int_{t_0}^{\infty} |c(\tau)| d\tau\right), \end{aligned} \tag{6.13}$$

where c_i are positive constants such that $c_1 \neq c_2$ and

$$1 \leq c_i \leq 2. \tag{6.14}$$

Let us show that $x_i \in \mathbb{M}^-, i = 1, 2$. It is easy to show that solutions x_i are positive decreasing on $[0, t_0]$. In order to prove that $x_i \in \mathbb{M}^-$, it will be sufficient to show that $x_i(t)x_i'(t) < 0$ for any $t \geq t_0$. Clearly solutions x_i are positive decreasing in a right neighborhood of t_0 . Assume there exists $t_i > t_0$ such that $x_i(t_i)x_i'(t_i) = 0, x_i(t) > 0, x_i'(t) < 0$ for $t_0 \leq t < t_i$. Integrating (0.1) on (t_0, t_i) we have

$$r(t_i)\Phi(x_i'(t_i)) - r(t_0)\Phi(x_i'(t_0)) = \int_{t_0}^{t_i} |c(\tau)|\Phi(x_i(\tau)) d\tau. \tag{6.15}$$

If $x_i'(t_i) = 0$, from (6.13) and (6.15) we obtain

$$\begin{aligned} c_i \int_{t_0}^{\infty} |c(\tau)| d\tau &= \int_{t_0}^{t_i} |c(\tau)|\Phi(x_i(\tau)) d\tau \leq \Phi(x_i(t_0)) \int_{t_0}^{t_i} |c(\tau)| d\tau \\ &= \int_{t_0}^{t_i} |c(\tau)| d\tau \end{aligned}$$

which implies

$$\int_{t_i}^{\infty} |c(\tau)| d\tau \leq 0,$$

that is a contradiction. Now suppose $x_i(t_i) = 0$. For $t \in (t_0, t_i)$ from

$$r(t)\Phi(x_i'(t)) \geq r(t_0)\Phi(x_i'(t_0)) = -c_i \int_{t_0}^{\infty} |c(\tau)| d\tau,$$

we obtain

$$x_i'(t) \geq -\Phi^{-1}(c_i)r^{1-q}(t)\Phi^{-1}\left(\int_{t_0}^{\infty} |c(\tau)| d\tau\right)$$

or

$$x_i(t_i) - x(t_0) = -1 \geq -\Phi^{-1}(c_i)\Phi^{-1}\left(\int_{t_0}^{\infty} |c(\tau)| d\tau\right) \int_{t_0}^{t_i} r^{1-q}(t) dt.$$

Thus, by virtue of (6.14),

$$1 \leq \Phi^{-1}(2)\Phi^{-1}\left(\int_{t_0}^{\infty} |c(\tau)| d\tau\right) \int_{t_0}^{\infty} r^{1-q}(t) dt,$$

which contradicts (6.12) and the necessity of (6.11) is proved.

Sufficiency. Let us show that for any $(t_0, x_0) \in [0, \infty) \times \mathbb{R} \setminus \{0\}$, there exists at most one solution x of (0.1) in the class \mathbb{M}^- such that $x(t_0) = x_0$ when $J_r = \infty$ or $J_c = \infty$. Let x, y be two solutions of (0.1) in the class \mathbb{M}^- such that $x(t_0) = y(t_0)$, $x'(t_0) > y'(t_0)$. Consider the function d given by $d(t) = x(t) - y(t)$. Then $d(t_0) = 0$, $d'(t_0) > 0$. We claim that d does not have positive points of maximum greater than t_0 , i.e.,

$$d(t) > 0, \quad d'(t) > 0 \quad \text{for } t > t_0.$$

Assume there exists $t_1 > t_0$ such that $d(t_1) > 0$, $d'(t_1) = 0$ and $d'(t) > 0$ in a suitable left neighborhood I of t_1 . Without loss of generality suppose that $d(t) > 0$ for $t \in I$. Now consider the function G given by

$$G(t) = r(t)[\Phi(x'(t)) - \Phi(y'(t))].$$

Hence $G(t_1) = 0$. Taking into account that Φ is increasing and $d'(t) > 0$, we have $G(t) > 0$, $t \in I$. In addition, from

$$G'(t) = |c(t)|[\Phi(x(t)) - \Phi(y(t))],$$

we obtain $G'(t) > 0$, $t \in I$, which gives a contradiction, because $G(t_1) = 0$. Hence the function d is increasing.

If $J_c = \infty$ then, by Lemma 6.3 we have $J_2 = \infty$. Then, in view of Corollary 6.1(a), we obtain $d(\infty) = 0$, that is a contradiction. If $J_r = \infty$, then taking into account that $d'(t) > 0$ for $t > t_0$, the function G satisfies $G(t) > 0$, $G'(t) > 0$ for $t > t_0$ and, by Lemma 6.4, $\lim_{t \rightarrow \infty} G(t) = 0$, that is a contradiction. Finally the existence of at least one solution $x \in \mathbb{M}^-$ such that $x(t_0) = x_0$ is assured by Proposition 6.1(i). \square

6.4. The case c positive

As already stated before, when c is eventually positive, Equation (0.1) may be either oscillatory or nonoscillatory. In the nonoscillation case, the asymptotic behavior of solutions has been considered by many authors. Here we refer in particular to [37,90,99,112,121,157,179,218] and references therein. In these papers certain asymptotic properties of nonoscillatory solutions are examined, under various assumptions on functions r, c , for equation (0.1) or, sometimes, for a more general equation (which includes (0.1)). In this section, similarly to Section 6.2, we will show how it is possible to obtain from these results, with a very simple argument, a complete description of the asymptotic behavior of solutions of (0.1) also when c is positive.

The following holds.

PROPOSITION 6.3. *Let $c(t) > 0$ for large t and $J_r = \infty$.*

- (i) *If $J_2 = \infty$, then $\mathbb{M}_B^+ = \emptyset$.*
- (ii) *If $J_2 < \infty$, then Equation (0.1) is nonoscillatory and $\mathbb{M}_B^+ \neq \emptyset$.*

PROOF. In view of Lemma 6.2(ii) any nonoscillatory solution of (0.1) is in the class \mathbb{M}^+ . Then claims (i) and (ii) follow from [112, Theorem 4.2]. □

The following “uniqueness” result will be useful in the proof of the existence of unbounded solutions. It is, in some sense, the analogous one to Theorem 6.6.

THEOREM 6.7 ([112, Theorem 4.3]). *Let $c(t) > 0$ for large t . Let $\eta \neq 0$ be a given constant and assume $J_r = \infty$, $J_2 < \infty$. Then there exists a unique solution x of (0.1), $x \in \mathbb{M}^+$, such that $\lim_{t \rightarrow \infty} x(t) = \eta$.*

By using such a result we obtain the following.

PROPOSITION 6.4. *Let $c(t) > 0$ for large t and assume $J_r = \infty$, $J_2 < \infty$. Then (0.1) has unbounded solutions, i.e., $\mathbb{M}_\infty^+ \neq \emptyset$.*

PROOF. Assume, by contradiction, that $\mathbb{M}_\infty^+ = \emptyset$. In view of Proposition 6.3, let u be a solution of (0.1) in the class \mathbb{M}_B^+ and let x be another solution of (0.1) such that $x(0) = u(0)$, $x'(0) \neq u'(0)$. Hence $x \neq u$ and from Lemma 6.2(ii) we have $x \in \mathbb{M}_B^+$. In view of Theorem 6.7 we have $u(\infty) \neq x(\infty)$. Now consider the solution w of (0.1) given by

$$w(t) = \frac{u(\infty)}{x(\infty)}x(t).$$

We have $w \in \mathbb{M}_B^+$. But $w(\infty) = u(\infty)$, that gives a contradiction. □

PROPOSITION 6.5. *Let $c(t) > 0$ for large t . If $J_r < \infty$, then (0.1) does not have unbounded nonoscillatory solutions, i.e., $\mathbb{M}_\infty^+ = \emptyset$.*

PROOF. The assertion follows, with minor changes, from [99, Lemma 2]. □

Concerning the existence in the class \mathbb{M}^- , the following hold.

PROPOSITION 6.6. *Let $c(t) > 0$ for large t .*

- (i) *If $J_r < \infty$, $J_c = \infty$, $J_1 < \infty$, then (0.1) is nonoscillatory and $\mathbb{M}_B^- \neq \emptyset$.*
- (ii) *If $J_1 = \infty$, then $\mathbb{M}_B^- = \emptyset$.*

PROOF. Claim (i) follows from [99, Theorem 4]. As for the claim (ii), let $x \in \mathbb{M}_B^-$ and, without loss of generality, assume $x(t) > 0$, $x'(t) < 0$ for $t \geq T$ and $x(\infty) = c_x > 0$. From (0.1) we have

$$x^{[1]}(t) = x^{[1]}(T) - \int_T^t c(s)\Phi(x(s)) \, ds < -\Phi(c_x) \int_T^t c(s) \, ds$$

or

$$x'(t) < -c_x \Phi^{-1} \left(\frac{1}{r(t)} \int_T^t c(s) \, ds \right).$$

Integrating over (T, t) we obtain

$$x(t) - x(T) < -c_x \int_T^t \Phi^{-1} \left(\frac{1}{r(s)} \int_T^s c(\tau) \, d\tau \right) \, ds$$

that gives a contradiction as $t \rightarrow \infty$. □

PROPOSITION 6.7. *Let $c(t) > 0$ for large t . If (0.1) is nonoscillatory and $J_r < \infty$, then $\mathbb{M}_0^- \neq \emptyset$.*

PROOF. If $J_c < \infty$, the assertion follows, as a particular case, from [179, Theorem 2.2]. When $J_c = \infty$ the assertion follows from [37, Lemma 2(ii)]. □

By considering the mutual behavior of integrals J_r, J_c, J_1, J_2 it is possible to summarize the situation in a complete way. Indeed, as regards the convergence or divergence of the above integrals, in view of Lemma 6.3, we have the following six possible cases:

- (C1) $J_r = J_c = J_1 = J_2 = \infty$,
- (C2) $J_r = J_1 = J_2 = \infty, J_c < \infty$,
- (C3) $J_r = J_1 = \infty, J_c < \infty, J_2 < \infty$,
- (C4) $J_c = J_1 = J_2 = \infty, J_r < \infty$,
- (C5) $J_c = J_2 = \infty, J_r < \infty, J_1 < \infty$,
- (C6) $J_r < \infty, J_c < \infty, J_1 < \infty, J_2 < \infty$.

If (C1) holds, then, as already claimed in Section 6.1, Equation (0.1) is oscillatory. In the remaining cases, from the above results, we obtain the following theorem, which is a natural extension of the previous one stated in the linear case [39, Theorem 1].

THEOREM 6.8. *Let $c(t) > 0$ for large t .*

If (C2) holds and (0.1) is nonoscillatory, then $\mathbb{M}_\infty^+ \neq \emptyset, \mathbb{M}_B^+ = \mathbb{M}_B^- = \mathbb{M}_0^- = \emptyset$.

If (C3) holds, then (0.1) is nonoscillatory and $\mathbb{M}_\infty^+ \neq \emptyset, \mathbb{M}_B^+ \neq \emptyset, \mathbb{M}_B^- = \mathbb{M}_0^- = \emptyset$.

If (C4) holds and (0.1) is nonoscillatory, then $\mathbb{M}_\infty^+ = \mathbb{M}_B^+ = \mathbb{M}_B^- = \emptyset, \mathbb{M}_0^- \neq \emptyset$.

If (C5) holds, then (0.1) is nonoscillatory and $\mathbb{M}_\infty^+ = \mathbb{M}_B^+ = \emptyset, \mathbb{M}_B^- \neq \emptyset, \mathbb{M}_0^- \neq \emptyset$.

If (C6) holds, then (0.1) is nonoscillatory and $\mathbb{M}_\infty^+ = \emptyset, \mathbb{M}_B^+ \neq \emptyset, \mathbb{M}_B^- \neq \emptyset, \mathbb{M}_0^- \neq \emptyset$.

PROOF. The proof follows from the previous statements of this section.

(C2) From Lemma 6.2(ii) and Proposition 6.3(i) we have $\mathbb{M}_B^+ = \mathbb{M}_B^- = \mathbb{M}_0^- = \emptyset$. Since (0.1) is nonoscillatory, we obtain $\mathbb{M}^+ = \mathbb{M}_\infty^+ \neq \emptyset$.

(C3) The assertion follows from Lemma 6.2(ii), Proposition 6.3(ii), Proposition 6.4.

(C4) From Lemma 6.2(i) and Proposition 6.6(ii) we have $\mathbb{M}_\infty^+ = \mathbb{M}_B^+ = \mathbb{M}_B^- = \emptyset$. Since (0.1) is nonoscillatory, we obtain $\mathbb{M}^- = \mathbb{M}_0^- \neq \emptyset$.

(C5) The assertion follows from Lemma 6.2(i), Proposition 6.6(i), Proposition 6.7.

(C6) From Proposition 6.2(iii), Proposition 6.5, Proposition 6.7, we obtain $\mathbb{M}_\infty^+ = \emptyset$, $\mathbb{M}_B^+ \neq \emptyset$, $\mathbb{M}_0^- \neq \emptyset$. Finally the existence in \mathbb{M}_B^- can be proved using an argument similar to that given in the proof of Theorem 6.1 (see also [218, Theorem 3.3] and its proof). □

Taking into account that the possible cases concerning the convergence or divergence of J_r, J_c, J_1, J_2 are the cases (C1)–(C6), from Theorem 6.8 we easily obtain the following interesting result, which gives a necessary and sufficient condition for the existence of nonoscillatory solutions of (0.1) in the classes $\mathbb{M}_\infty^+, \mathbb{M}_B^+, \mathbb{M}_B^-, \mathbb{M}_0^-$.

THEOREM 6.9. *Let $c(t) > 0$ for large t .*

- (i) *Assume (0.1) nonoscillatory. The class \mathbb{M}_∞^+ is nonempty if and only if $J_r = \infty$.*
- (ii) *The class \mathbb{M}_B^+ is nonempty if and only if $J_2 < \infty$.*
- (iii) *Assume (0.1) nonoscillatory. The class \mathbb{M}_0^- is nonempty if and only if $J_r < \infty$.*
- (iv) *The class \mathbb{M}_B^- is nonempty if and only if $J_1 < \infty$.*

REMARK 6.2. Interesting results on asymptotic properties of nonoscillatory solutions of the equation

$$(\Phi(x'))' + c(t)\Phi(x) = 0, \tag{6.16}$$

based on the concepts of *slowly* and *regularly* varying functions, can be found in the recent paper [117]. Since the presentation of these results of this paper requires the introduction of several auxiliary statements, we will not formulate these results here and we refer to the above mentioned paper [117].

7. Principal solution

The concept of the principal solution of the linear second order differential equation (1.1) was introduced in 1936 by Leighton and Morse [148] and plays an important role in the oscillation and asymptotic theory of (1.1). In this section we show that this concept can be introduced also for (nonoscillatory) half-linear equation (0.1).

7.1. Principal solution of linear equations

First we recall basic properties of the principal solution of linear equation (1.1). Suppose that this equation is nonoscillatory, i.e., any solution of this equation is eventually positive or negative. Then, using the below described method, one can distinguish among all solutions of this equation a solution \tilde{x} , called the *principal solution*, (determined uniquely up to a multiplicative factor) which is near ∞ less than any other solution of this equation in the sense that

$$\lim_{t \rightarrow \infty} \frac{\tilde{x}(t)}{x(t)} = 0$$

for any solution x which is linearly independent of \tilde{x} .

Let x, y be eventually positive linearly independent solution of (1.1), then

$$r(t)[x'(t)y(t) - x(t)y'(t)] =: \omega \neq 0.$$

This means that the function $\frac{x}{y}$ is monotonic and hence there exists (finite or infinite) limit $\lim_{t \rightarrow \infty} \frac{x(t)}{y(t)} = L$. If $L = 0$, the solution x the principal solution of (1.1), if $L = \infty$, the principal solution is y . If $0 < L < \infty$, we set $\tilde{x} = x - Ly$. Then obviously $\lim_{t \rightarrow \infty} \frac{\tilde{x}(t)}{y(t)} = 0$ and \tilde{x} is the principal solution. Observe that this construction of the principal solution is based on the linearity of the solution space of (1.1).

Using the Wronskian identity, the principal solution \tilde{x} of (1.1) is equivalently characterized as a solution satisfying

$$\int^{\infty} \frac{dt}{r(t)\tilde{x}^2(t)} = \infty. \quad (7.1)$$

Indeed, let y be a solution linearly independent of \tilde{x} . Then by the previous argument $\frac{y}{\tilde{x}}$ tends monotonically to ∞ as $t \rightarrow \infty$, hence

$$\lim_{t \rightarrow \infty} \int^t \frac{ds}{r(s)\tilde{x}^2(s)} = \lim_{t \rightarrow \infty} \frac{y(t)}{\tilde{x}(t)} = \infty. \quad (7.2)$$

Another characterization of the principal solution of (1.1) is via the eventually minimal solution of the associated Riccati equation

$$w' + c(t) + \frac{w^2}{r(t)} = 0. \quad (7.3)$$

Let \tilde{x}, x be linearly independent solutions of (1.1), the solution \tilde{x} being principal, and let $\tilde{w} = \frac{r\tilde{x}'}{\tilde{x}}$, $w = \frac{rx'}{x}$ be the solutions of the associated Riccati equation. Without loss of generality we may suppose that \tilde{x} and x are eventually positive. We have

$$w(t) - \tilde{w}(t) = \frac{r(t)y'(t)}{y(t)} - \frac{r(t)\tilde{x}'(t)}{\tilde{x}(t)} = \frac{r(t)[x'(t)\tilde{x}(t) - \tilde{x}'(t)x(t)]}{\tilde{x}(t)x(t)}.$$

The numerator of the last fraction is a constant and this constant is positive since we have $(\frac{x}{\tilde{x}})' = \frac{r[x\tilde{x}' - \tilde{x}'x]}{r\tilde{x}^2} > 0$ which follows from the fact that \tilde{x} is the principal solution, i.e., $\frac{x}{\tilde{x}}$ tends monotonically to ∞ . Hence, the solution \tilde{w} of the Riccati equation (7.3) given by the principal solution of (1.1) is less than any other solution of (7.3) near ∞ . Conversely, let $\tilde{w} = r\tilde{x}'/\tilde{x}$ be the minimal solution of (2.1) and suppose that the solution \tilde{x} of (1.1) is not principal, i.e., the integral in (7.1) is convergent. Let $T \in \mathbb{R}$ be such that $\int_T^{\infty} r^{-1}(t)\tilde{x}^{-2}(t) dt < 1$ and consider the solution w of (7.3) given by the initial condition $w(T) = \tilde{w}(T) - \frac{1}{2\tilde{x}^2(T)}$. Put $v = \tilde{x}^2(\tilde{w} - w)$. Then $v(T) = \frac{1}{2}$ and by a direct computation we have

$$v' = \frac{v^2}{r(t)\tilde{x}^2(t)}.$$

Hence

$$v(t) = \frac{1}{2 - \int_T^t r^{-1}(s)\tilde{x}^{-2}(s) ds} \leq \frac{1}{2 - \int_T^\infty r^{-1}(s)\tilde{x}^{-2}(s) ds} \leq 1.$$

This means that v is extensible up to ∞ and hence w has the same property and at the same time $w(t) < \tilde{w}(t)$. This contradiction shows that the eventual minimality of \tilde{w} implies that (7.1) holds, i.e., the associated solution \tilde{x} of (0.1) is principal.

The last construction of the principal solution of (1.1) which we present here requires (in addition to nonoscillation of (1.1)) the assumption that for any t_0 , the solution of (1.1) given by the initial condition $x(t_0) = 0, x'(t_0) \neq 0$ has a zero point rights of t_0 (later we will show that this assumption can be eliminated), we denote this zero point by $\eta(t_0)$. The function η is nondecreasing according to the Sturmian theory, hence there exists $\lim_{t \rightarrow \infty} \eta(t) =: T$ and $T < \infty$ since we suppose that (1.1) is nonoscillatory. Now, the solution \tilde{x} given by the initial condition $\tilde{x}(T) = 0, \tilde{x}'(T) \neq 0$ is the principal solution of (1.1). This construction is used in the original paper of Leighton and Morse [148]. Concerning other papers dealing with the principal solution of (1.1) and its properties we refer to [106] and the references given therein.

7.2. Mirzov's construction of the principal solution

This construction defines the principal solution of half-linear equation (0.1) via the minimal solution of the associated Riccati equation (2.1). Nonoscillation of (0.1) implies that there exist $T \in \mathbb{R}$ and a solution \hat{w} of (2.1) which is defined in the whole interval $[T, \infty)$, i.e., such that (0.1) is disconjugate on $[T, \infty)$. Let $d \in (T, \infty)$ and let w_d be the solution of (2.1) determined by the solution x_d of (0.1) satisfying the initial condition $x(d) = 0, r(d)\Phi(y'(d)) = -1$. Then $w_d(d-) = -\infty$ and $w_d(t) < \hat{w}(t)$ for $t \in (T, d)$. Moreover, if $T < d_1 < d_2$ then

$$w_{d_1}(t) < w_{d_2}(t) < \hat{w}(t) \quad \text{for } t \in (T, d_1).$$

This implies that for $t \in (T, \infty)$ there exists the limit $w_\infty(t) := \lim_{d \rightarrow \infty} w_d(t)$ and monotonicity of this convergence (with respect to the “subscript” variable) implies that this convergence is uniform on every compact subinterval of $[T, \infty)$. Consequently, the limit function w_∞ solves (2.1) as well and any solution w of this equation which is extensible up to ∞ satisfies the inequality $w(t) > w_\infty(t)$ near ∞ . Indeed, if a solution \tilde{w} would satisfy the inequality $\tilde{w}(t) < w_\infty(t)$ on some interval (T_1, ∞) , then for $\bar{t} \in (T_1, \infty)$ and d sufficiently large we have $\tilde{w}(\bar{t}) < w_d(\bar{t}) < w_\infty(\bar{t})$. But this contradicts the fact that $w_d(d-) = -\infty$ and that graphs of solutions of (2.1) cannot intersect (because of unique solvability of this equation).

Now, having defined the *minimal solution* w_∞ of (2.1), we define the *principal solution* of (0.1) at ∞ as the (nontrivial) solution of the first order equation

$$x' = \Phi^{-1}\left(\frac{w(t)}{r(t)}\right)x, \tag{7.4}$$

i.e., the principal solution of (0.1) at ∞ is determined uniquely up to a multiplicative factor by the formula

$$x(t) = x(T) \exp \left\{ \int_T^t r^{1-q}(s) \Phi^{-1}(w(s)) \, ds \right\}.$$

REMARK 7.1. (i) Mirzov actually used in his paper [177] a slightly different approach which can be briefly explained as follows. Suppose that (0.1) is nonoscillatory and let \hat{w} be a solution of the associated Riccati equation which exists on some interval $[T, \infty)$ and let $W := \hat{w}(T)$. Denote by

$$\mathcal{W} = \left\{ v \in (-\infty, W) : \text{the solution } w \text{ of (2.1) given by the initial condition } w(T) = v \text{ is not extensible up to } \infty \right\},$$

i.e., \mathcal{W} are initial values of solutions of (2.1) at $t = T$ which blow down to $-\infty$ at some finite time $t > T$. Note that the set \mathcal{W} is nonempty what can be seen as follows. Let $T_1 > T$ be arbitrary and consider a solution x of (0.1) given by $x(T_1) = 0, x'(T_1) \neq 0$. Disconjugacy of (0.1) on $[T, \infty)$ implies that $x(t) \neq 0$ on $[T, T_1)$ and the value of the associated solution of the Riccati equation $w = \frac{r\Phi(x')}{\Phi(x)}$ at $t = T$ clearly belongs to \mathcal{W} . Now, let $\tilde{v} := \sup \mathcal{W}$ and let w_∞ be the solution of (2.1) given by the initial condition $w(T) = \tilde{v}$. Then this solution is extensible up to ∞ (supposing that this is not the case, we would get a contradiction with the definition of the number \tilde{v}) and the principal solution of (0.1) is defined again by (7.4) with w_∞ substituted for w .

(ii) Let b be a *regular* point of Equation (0.1) in the sense that for any $A, B \in \mathbb{R}$ the initial condition $x(b) = A, r(b)\Phi(x'(b)) = B$ determines uniquely a solution of (0.1). Let x_b be a solution given by $x_b(b) = 0, x'_b(b) \neq 0$. Replacing in the above construction the point $t = \infty$ by $t = b$, i.e., $w_b(t) := \lim_{d \rightarrow b-} w_d(t)$, it not difficult to see that $w_b = \frac{r\Phi(x'_b)}{\Phi(x_b)}$. Consequently, what we call the principal solution x_b of (0.1) at a regular point $b \in \mathbb{R}$ is the nontrivial solution satisfying the condition $x_b(b) = 0$.

7.3. Construction of Elbert and Kusano

This construction was introduced (independently of Mirzov’s approach) in the paper [90] and it is based on the half-linear Prüfer transformation.

Let (0.1) be nonoscillatory and let T be such that this equation is disconjugate on $[T, \infty)$. Take a solution x which is positive on $[T, \infty)$. By the generalized Prüfer transformation (see Section 1.3) this solution can be expressed in the form

$$x(t) = \rho(t) \sin_p \varphi(t), \quad r^{q-1}(t)x'(t) = \rho(t) \cos_p \varphi(t), \tag{7.5}$$

where ρ is a positive function, the half-linear sine and cosine functions \sin_p, \cos_p were defined in Section 1.3 and the function φ is a solution of the first order equation

$$\varphi' = r^{1-q}(t) |\cos_p \varphi(t)|^p + \frac{c(t)}{p-1} |\sin_p \varphi(t)|^p. \tag{7.6}$$

The fact that $x(t) > 0$ for $t \in [T, \infty)$ implies that $\varphi(t) \in (k\pi_p, (k + 1)\pi_p)$ for some even $k \in \mathbb{Z}$ and without loss of generality we can suppose that $k = -1$. Now, let $\tau \in (T, \infty)$ and let φ_τ be the solution of (7.6) given by the initial condition $\varphi_\tau(\tau) = 0$. Since any solution of (7.6) satisfies $\varphi'(t) > 0$ whenever $\varphi(t) = 0 \pmod{\pi_p}$, the unique solvability of (7.6) (compare again Section 1.3) implies that

$$\varphi(t) < \varphi_{\tau_2}(t) < \varphi_{\tau_1}(t) \quad \text{for } t \geq T, \text{ whenever } T < \tau_1 < \tau_2$$

(drawing a picture helps to visualize the situation). Consequently, the monotonicity of φ_τ with respect to τ implies that there exists a finite limit

$$\lim_{\tau \rightarrow \infty} \varphi_\tau(T) = \varphi^*.$$

Now, the *principal solution* is the solution of (0.1) given by the initial condition

$$\tilde{x}(T) = \sin \varphi^*, \quad \tilde{x}'(T) = r^{1-q}(T) \cos_p \varphi^*.$$

This means that we take $\rho(T) = 1$ in the definition of \tilde{x} , this can be done according to the homogeneity of the solution space of (0.1).

THEOREM 7.1. *A solution \tilde{x} of a nonoscillatory equation (0.1) is principal in sense of Mirzov's construction if and only if it is principal in the sense of Elbert and Kusano.*

PROOF. Let x_τ be a nontrivial solution of (0.1) satisfying $x_\tau(\tau) = 0$. This solution can be expressed in the form

$$x_\tau(t) = \rho(t) \sin_p \varphi_\tau(t), \quad r^{q-1}(t)x'_\tau(t) = \rho(t) \cos_p \varphi_\tau(t),$$

where φ_τ is the solution of (7.6) satisfying $\varphi_\tau(\tau) = 0$. The corresponding solution of the associated Riccati equation (2.1)

$$w_\tau(t) = \frac{r(t)\Phi(x'_\tau(t))}{\Phi(x_\tau(t))} = \Phi(\cot_p \varphi_\tau(t))$$

satisfies $w_\tau(\tau-) = -\infty$. The minimal solution of (2.1) (which defines the principal solution of (0.1) in Mirzov's definition) is given by $\tilde{w}(t) = \lim_{\tau \rightarrow \infty} w_\tau(t)$, i.e., it is just the solution satisfying $\tilde{w}(T) = \Phi(\cot_p \varphi^*)$ and this is the solution of Riccati equation (2.1) given by the principal solution obtained by Elbert–Kusano's construction. \square

We finish this subsection with some examples of equations whose principal solution can be computed explicitly.

EXAMPLE 7.1. (i) Consider the one-term half-linear equation

$$(r(t)\Phi(x'))' = 0. \tag{7.7}$$

As we have mentioned in Section 4, the solution space of this equation is a two-dimensional linear space with the basis $x_1(t) \equiv 1$, $x_2(t) = \int^t r^{1-q}(s) ds$. The Riccati equation associated with (7.7) is $w' + (p - 1)r^{1-q}|w|^q = 0$ and the general solution of this equation is

$$w(t) = \frac{1}{\Phi(C + \int_T^t r^{1-q}(s) ds)}, \quad w(t) \equiv 0. \tag{7.8}$$

If $\int^\infty r^{1-q}(t) dt = \infty$, then by an easy computation one can verify that $\tilde{w}(t) \equiv 0$ is the eventually minimal solution of this equation and hence $\tilde{x}(t) = 1$ is the principal solution of (0.1). If $\int^\infty r^{1-q}(t) dt < \infty$, the eventually minimal solution of the Riccati equation is $w(t) = -\frac{1}{\Phi(\int_t^\infty r^{1-q}(s) ds)}$ (we take $C = -\int_T^\infty r^{1-q}(s) ds$ in formula (7.8)) and $\tilde{x}(t) = \int_t^\infty r^{1-q}(s) ds$ is the principal solution of (0.1).

(ii) The nonoscillatory equation $(\Phi(x'))' - (p - 1)\Phi(x) = 0$ investigated in Section 4.1 has solutions $x(t) = e^{\pm t}$ and all other solutions are asymptotically equivalent to e^t . Consequently, the solution $\tilde{x}(t) = e^{-t}$ is the principal solution at ∞ .

(iii) The Euler-type equation

$$(\Phi(x'))' + \frac{\gamma}{t^p}\Phi(x) = 0 \tag{7.9}$$

is nonoscillatory if and only if $\gamma \leq \tilde{\gamma} = (\frac{p-1}{p})^p$, see Section 4.2. If $\gamma = \tilde{\gamma}$, then (7.9) has a solution $x(t) = t^{\frac{p-1}{p}}$ and all linearly independent solutions are asymptotically equivalent to $t^{\frac{p-1}{p}} \lg^{\frac{2}{p}} t$. Consequently, $\tilde{x}(t) = t^{\frac{p-1}{p}}$ is the principal solution of (7.9). If $\gamma < \tilde{\gamma}$, then $x_1(t) = e^{\lambda_1 t}$, $x_2(t) = e^{\lambda_2 t}$, where $\lambda_1 < \lambda_2$ are the roots of the algebraic equation $(p - 1)[|\lambda|^p - \Phi(\lambda)] + \gamma = 0$, are solutions of (7.9), and all other linearly independent solutions are asymptotically equivalent to $x_2(t)$. Consequently, $\tilde{x}(t) = x_1(t) = e^{\lambda_1 t}$.

7.4. Comparison theorem for eventually minimal solutions of Riccati equations

Similarly as in the linear case we have the following inequalities for solutions of a pair of Riccati equations corresponding to nonoscillatory half-linear equations.

THEOREM 7.2. *Consider a pair of half-linear equations (0.1), (2.13), and suppose that (2.13) is a Sturmian majorant of (0.1) for large t, i.e., there exists $T \in \mathbb{R}$ such that $0 < R(t) \leq r(t)$, $c(t) \leq C(t)$ for $t \in [T, \infty)$. Suppose that the majorant equation (2.13) is nonoscillatory and denote by \tilde{w} , \tilde{v} eventually minimal solutions of (2.1) and of*

$$v' + C(t) + (p - 1)R^{1-q}(t)|v|^q = 0, \tag{7.10}$$

respectively. Then $\tilde{w}(t) \leq \tilde{v}(t)$ for large t.

PROOF. Nonoscillation of (2.13) implies the existence of $T \in \mathbb{R}$ such that \tilde{w} and \tilde{v} exist on $[T, \infty)$. Suppose that there exists $t_1 \in [T, \infty)$ such that $\tilde{w}(t_1) > \tilde{v}(t_1)$. Let w be the solution of (2.1) given by the initial condition $w(t_1) = \tilde{v}(t_1)$. Then according to the standard

theorem on differential inequalities (see, e.g., [145]) we have $w(t) \geq \tilde{v}(t)$ for $t \geq t_1$, i.e., w is extensible up to ∞ . At the same time $w(t) < \tilde{w}(t)$ for $t \geq t_1$ since graphs of solutions of (2.1) cannot intersect (because of the unique solvability). But this contradicts the eventual minimality of \tilde{w} . \square

In some oscillation criteria, we will need the following immediate consequence of the previous theorem.

COROLLARY 7.1. *Let $\int^\infty r^{1-q}(t) dt = \infty$, $c(t) \geq 0$ for large t and suppose that (0.1) is nonoscillatory. Then the eventually minimal solution of the associated Riccati equation (2.1) satisfies $\tilde{w}(t) \geq 0$ for large t .*

PROOF. Under the assumptions of corollary, (0.1) is the majorant of the one-term equation $(r(t)\Phi(y'))' = 0$. Since $\int^\infty r^{1-q}(t) dt = \infty$, $\tilde{y} \equiv 1$ is the principal solution of this equation (compare Example 7.1). Hence $\tilde{v}(t) = 0$ is the eventually minimal solution of the associated Riccati equation which implies the required statement. \square

7.5. Sturmian property of the principal solution

In this short subsection we briefly show that the principal solution of (0.1) has a Sturmian-type property and that the largest zero point of this solution (if any) behaves like the left conjugate point of ∞ , in a certain sense.

THEOREM 7.3. *Suppose that Equation (0.1) is nonoscillatory and its principal solution \tilde{x} has a zero point and let T be the largest of them. Further suppose that Equation (2.13) is a Sturmian majorant of (0.1) on $[T, \infty)$, i.e., $0 < R(t) \leq r(t)$ and $C(t) \geq c(t)$ for $t \in [T, \infty)$. Then any solution y of (2.13) has a zero point in (T, ∞) or it is a constant multiple of \tilde{x} . The latter possibility is excluded if one of the inequalities between r, R and c, C , respectively, is strict on an interval of positive length.*

PROOF. If (2.13) is oscillatory, the statement of theorem trivially holds, so suppose that (2.13) is nonoscillatory and let \tilde{y} be its principal solution. Denote by \tilde{w} and \tilde{v} the minimal solutions of corresponding Riccati equations (2.1) and (7.10), respectively. According to the comparison theorem for minimal solutions of Riccati equations presented in the previous subsection, we have $\tilde{w}(t) \geq \tilde{v}(t)$ on the interval of existence of \tilde{w} . Since we suppose that $\tilde{x}(T) = 0$, this implies that $\tilde{w}(T+) = \infty$, so the interval of existence of \tilde{v} must be a subinterval of $[T, \infty)$, say $[T_1, \infty)$, i.e., T_1 is the largest zero of the principal solution \tilde{y} of (2.13). If one of the inequalities between r, R and c, C is strict it can be shown that the possibility $T = T_1$ is excluded. Now let y be any nontrivial solution of (2.13). If $y(t) \neq 0$ for $t \in [T_1, \infty)$, then the associated solution $v = R\Phi(y')/\Phi(y)$ exists on $[T_1, \infty)$ and satisfies there the inequality $v(t) < \tilde{v}(t)$ on $[T_1, \infty)$ (since $\tilde{v}(T_1+) = \infty$ and $v(T-) < \infty$) and this a contradiction with minimality of \tilde{v} . \square

REMARK 7.2. (i) If T is the largest zero of the principal solution \tilde{x} of (0.1), i.e., the same as in the previous theorem, and suppose that $R(t) = r(t)$ and $C(t) = c(t)$ for $t \in [T, \infty)$.

Then Theorem 7.3 shows that T plays the role of the left conjugate point of ∞ in the sense that any nonprincipal solution of (0.1), i.e., a solution linearly independent of \tilde{x} , has exactly one zero in (T, ∞) . Note that the fact that this zero is exactly one (and not more) follows from the classical Sturm separation theorem (Theorem 2.3).

(ii) In Remark 2.2 we have pointed out that the disconjugacy of (0.1) on a bounded interval $I = [a, b]$ (which, by definition, means that the solution x given by $x(a) = 0$, $x'(a) \neq 0$ has no zero in $(a, b]$) is actually equivalent to the existence of a solution without any zero in $[a, b]$. Theorem 7.3 shows that we have the same situation with unbounded intervals or an interval whose endpoints are singular points of (0.1). For example, if $I = \mathbb{R} = (-\infty, \infty)$, then disconjugacy of (0.1) on this interval (defined as disconjugacy on $[-T, T]$ for every $T > 0$) is equivalent to the existence of a solution without any zero on \mathbb{R} , the solution having this property is, e.g., the principal solution (at ∞).

7.6. Integral characterization of the principal solution

Among all (equivalent) characterizations of the principal solution of linear equation (1.1), the most suitable seems to be the integral one (7.1), since it needs to know just only one solution and according to the divergence/convergence of the characterizing integral it is possible to decide whether or not it is the principal solution. The remaining characterizations require to know other solutions since they are of comparison type. In the linear case, this is not serious disadvantage because of the reductions of order formula which enables to compute all solutions (at least locally) of the linear second order equation when one solution is already known. However, in the half-linear case we have no reduction of order formula as pointed in Section 3, so some kind of the integral characterization would be very useful. In the next theorem we present one candidate for the integral characterization of the principal solution of (0.1). The parts (i), (ii) and (iii) are proved in [66] and the part (iv) in [36].

THEOREM 7.4. *Suppose that Equation (0.1) is nonoscillatory and \tilde{x} is its solution such that $\tilde{x}'(t) \neq 0$ for large t .*

(i) *Let $p \in (1, 2)$. If*

$$I(\tilde{x}) := \int^{\infty} \frac{dt}{r(t)\tilde{x}^2(t)|\tilde{x}'(t)|^{p-2}} = \infty, \quad (7.11)$$

then \tilde{x} is the principal solution.

- (ii) *Let $p > 2$. If \tilde{x} is the principal solution then (7.11) holds.*
 (iii) *Suppose that $\int^{\infty} r^{1-q}(t) dt = \infty$, the function $\gamma(t) := \int_t^{\infty} c(s) ds$ exists and $\gamma(t) \geq 0$, but $\gamma(t) \not\equiv 0$ eventually. Then $\tilde{x}(t)$ is the principal solution if and only if (7.11) holds.*
 (iv) *Let $c(t) > 0$ for large t , $\int^{\infty} r^{1-q}(t) dt < \infty$, $\int^{\infty} c(t) dt = \infty$. Then $\tilde{x}(t)$ is the principal solution if and only if (7.11) holds.*

PROOF. (i) Suppose, by contradiction, that a (positive) solution x of (0.1) satisfying (7.11) is not principal. Then the corresponding solution $w_x = r\Phi(x'/x)$ of the associated Ric-

cati equation (2.1) is not eventually minimal. Hence, there exists another nonoscillatory solution y of (0.1) such that

$$w_y = r\Phi(y'/y) < w_x \quad \text{eventually.} \tag{7.12}$$

Due to the Picone identity given in Section 2.2 we have

$$r(t)|x'|^p - c(t)x^p = [x^p w_y]' + pr^{1-q}(t)x^p P(\Phi^{-1}(w_x), w_y)$$

and at the same time

$$r(t)|x'|^p - c(t)x^p = (x^p w_x)' - x[(r(t)\Phi(x'))' + c(t)\Phi(x)] = (x^p w_x)'.$$

Subtracting the last two equalities, we get

$$[x^p(w_x - w_y)]' = pr^{1-q}(t)x^p P(\Phi^{-1}(w_x), w_y).$$

Let $f(t) = x^p(w_x - w_y)$. By (7.12) there exists T sufficiently large such that $f(t) > 0$ for $t \geq T$. Then by Lemma 2.1 we have

$$\begin{aligned} \frac{f'}{f^2} &= \frac{p}{f^2} r^{1-q}(t)x^p P(\Phi_q(w_x), w_y) \\ &> \frac{p}{2} \frac{x^p r^{1-q}}{[x^p(w_x - w_y)]^2} |r^{q-1}(x'/x)|^{2-p} (w_x - w_y)^2 \\ &= \frac{p}{2r(t)x^2|x'|^{p-2}}. \end{aligned}$$

Integrating the last inequality from T to T_1 ($T_1 > T$), we have

$$\frac{1}{f(T)} > \frac{1}{f(T)} - \frac{1}{f(T_1)} \geq \frac{p}{2} \int_T^{T_1} \frac{dt}{r(t)x^2(t)|x'(t)|^{p-2}}$$

and letting $T_1 \rightarrow \infty$ we are led to contradiction. Hence a solution satisfying (7.11) is principal.

(ii) We proceed again by contradiction. Suppose that \tilde{x} is the principal solution and $I(\tilde{x}) < \infty$. Let T be chosen so large that $\tilde{x}(t) > 0$ for $t \geq T$ and

$$\int_T^\infty \frac{dt}{r(t)\tilde{x}^2(t)|\tilde{x}'(t)|^{p-2}} < \frac{1}{p}.$$

Consider the solution $\bar{w}(t)$ of the Riccati equation (2.1) given by the initial condition

$$\bar{w}(T) = \tilde{w}(T) - \frac{1}{2\tilde{x}^p(T)},$$

where $\tilde{w} = r\Phi(\tilde{x}'/\tilde{x})$, i.e., $\tilde{w}(T) < w(T)$. We want to show that $\tilde{w}(t)$ is extensible up to ∞ . To this end, denote $f(t) = \tilde{x}^p(t)(\tilde{w}(t) - \bar{w}(t))$. Then $f(T) = \frac{1}{2}$ and using the Picone identity, we have

$$\frac{f'(t)}{f^2(t)} = \frac{pr^{1-q}(t)}{f^2(t)} P(r^{q-1}\tilde{x}', \bar{w}\Phi(\tilde{x})),$$

hence, integrating this identity from T to t

$$\frac{1}{f(T)} - \frac{1}{f(t)} = p \int_T^t \frac{r^{1-q}(s)\tilde{x}^p(s)}{f^2(s)} P\left(r^{q-1}\frac{\tilde{x}'}{\tilde{x}}, \bar{w}\right) ds. \tag{7.13}$$

By (2.8) of Lemma 2.1 we have

$$P\left(\frac{r^{q-1}\tilde{x}'}{\tilde{x}}, \bar{w}\right) \leq \frac{1}{2} \left| \frac{r^{q-1}\tilde{x}'}{\tilde{x}} \right|^{2-p} (w - \bar{w})^2,$$

which means, using (7.13) and taking into account that $f(T) = \frac{1}{2}$,

$$\begin{aligned} f(t) &\leq \left(2 - p \int_T^t \frac{r^{1-q}(s)\tilde{x}^p(s)}{f^2(s)} P\left(r^{q-1}\frac{\tilde{x}'}{\tilde{x}}, \bar{w}\right) ds \right)^{-1} \\ &\leq \left(2 - p \int_T^\infty \frac{dt}{2r(t)\tilde{x}^2(t)|\tilde{x}'(t)|^{p-2}} \right)^{-1} \leq 1. \end{aligned}$$

Consequently, $\frac{1}{2} \leq f(t) \leq 1$ and $f(t)$ can be continued to ∞ , hence $\tilde{w}(t)$ is a continuable up to infinity solution of (2.1) and $\tilde{w}(t) < \tilde{w}(t)$ for $t \geq T$, i.e., $\tilde{w}(t)$ is not minimal. Thus, the solution $\tilde{x}(t)$ is not principal, which was to be proved.

(iii) The principal solution $\tilde{x}(t)$ of (0.1) is associated with the minimal solution $\tilde{w}(t)$ of (2.1) and hence it is also the minimal solution of the Riccati integral equation (the convergence of $\int^\infty r^{1-q}(t)|w(t)|^q dt$ follows from Theorem 5.6)

$$\tilde{w}(t) = \gamma(t) + (p - 1) \int_t^\infty r^{1-q}(s)|\tilde{w}(s)|^q ds, \quad t \geq T_1,$$

and by the assumptions on $\gamma(t)$, there exists $T \in \mathbb{R}$ such that $\tilde{w}(t) > 0$ for $t \geq T$. Since \tilde{w} is the minimal solution, for any other proper solution w of (2.1) we have $w(t) > \tilde{w}(t) > 0$ for $t \geq T_1 \geq T$, and hence the associated solutions $x(t)$ and $\tilde{x}(t)$ satisfy the inequalities $x'(t) > 0, \tilde{x}'(t) > 0$ for $t \geq T_1$.

Now the proof goes in different way according to $1 < p < 2$ or $p \geq 2$.

Case A: $1 < p < 2$. By the part (i) it is sufficient to show that the integral in (7.11) is really divergent. Suppose the contrary, i.e.,

$$\int^\infty \frac{dt}{r(t)\tilde{x}^2(t)|\tilde{x}'(t)|^{p-2}} < \infty.$$

Let $T_2 \geq T_1$ be chosen so large that

$$\int_{T_2}^{\infty} \frac{dt}{r(t)\tilde{x}^2(t)|\tilde{x}'(t)|^{p-2}} \leq \frac{2(p-1)}{p}.$$

Consider the solution $\bar{w}(t)$ of (2.1) with the initial condition

$$\bar{w}(T_2) = \tilde{w}(T_2) - \frac{1}{2\tilde{x}^2(T_2)},$$

and accordingly, the function $f(t)$ be defined by

$$f(t) = \tilde{x}^p(t)[\tilde{w}(t) - \bar{w}(t)].$$

Clearly, $f(T_2) = \frac{1}{2}$. Following the computation in the proof of the claim (i), we find

$$\frac{f'(t)}{f^2(t)} = p \frac{r^{1-q}(t)\tilde{x}^p(t)}{f^2(t)} P(\Phi^{-1}(\tilde{w}(t)), \bar{w}(t))$$

hence by (2.9)

$$\frac{f'(t)}{f^2(t)} < \frac{p}{2(p-1)} \frac{1}{r(t)\tilde{x}^2(t)|\tilde{x}'(t)|^{p-2}}$$

and integrating this inequality over $[T_2, t]$ we find

$$\begin{aligned} \frac{1}{f(T_2)} - \frac{1}{f(t)} &< \frac{1}{2} \frac{p}{p-1} \int_{T_2}^t \frac{ds}{r(s)\tilde{x}^2(s)|\tilde{x}'(s)|^{p-2}} \\ &< \frac{p}{2(p-1)} \int_{T_2}^{\infty} \frac{ds}{r(s)\tilde{x}^2(s)|\tilde{x}'(s)|^{p-2}} \leq 1, \end{aligned}$$

consequently, $\frac{1}{2} \leq f(t) \leq 1$ for $t \geq T_2$. Thus, the function $\bar{w}(t)$ exists on $[T_2, \infty)$ and $\bar{w}(t) < \tilde{w}(t)$, i.e., $\tilde{w}(t)$ is not minimal solution of (2.1), hence $\tilde{x}(t)$ is not the principal solution, and this contradiction proves the first case.

Case B: $p \geq 2$. By the claim (ii) it is sufficient to show that if the solution x is not principal then the corresponding integral in (7.11) is convergent. Let $w(t) = r(t)\Phi(x'(t)/x(t))$ be the associated solution of (2.1). Then $w(t)$ is not minimal solution of (2.1) and let $\tilde{w}(t)$ be the minimal solution of this equation. Then we have $w(t) > \tilde{w}(t)$ for $t \geq T_2$ with T_2 sufficiently large. Consider the function $f(t)$ given again by

$$f(t) = x^p(t)[w(t) - \tilde{w}(t)] > 0 \quad \text{for } t \geq T_2.$$

By inequality (2.9) given in Lemma 2.1 we have again

$$\frac{f'}{f^2} = \frac{p}{f^2} r^{1-q} x^p P(\Phi^{-1}(w), \tilde{w}) > \frac{p}{2(p-1)} \frac{1}{r x^2 |x'|^{p-2}}, \quad t \geq T_2,$$

hence

$$\frac{1}{f(T_2)} > \frac{1}{f(T_2)} - \frac{1}{f(t)} \geq \frac{p}{2(p-1)} \int_{T_2}^t \frac{ds}{rx^2|x'|^{p-2}},$$

then letting $t \rightarrow \infty$ we obtain the desired result

$$\int^{\infty} \frac{dt}{r(t)x^2(t)|x'(t)|^{p-2}} < \infty.$$

(iv) Concerning the proof of the part (iv), this proof is based on the statement which relates the principal solution of (0.1) to the principal solution of the reciprocal equation (6.1), we refer to [36] for details. \square

REMARK 7.3. The equivalent integral characterization of the principal solution of (0.1) is stated in the parts (iii) and (iv) of the previous theorem is proved under some restriction on the functions r, c in (0.1). In order to better understand these restrictions, the concept of the *regular* half-linear equation has been introduced in [72] as follows. A nonoscillatory equation (0.1) is said to be regular if there exists a constant $K \geq 0$ such that

$$\limsup_{t \rightarrow \infty} \left| \frac{w_1(t)}{w_2(t)} \right| \leq K$$

for any pair of solutions w_1, w_2 of the associated Riccati equation (2.1) such that $w_2(t) > w_1(t)$ eventually. It was shown that for regular half-linear equation (7.11) holds if and only if the solution \tilde{x} is principal and that under assumptions of (iii) and (iv) of the previous theorem equation (0.1) is regular.

7.7. Another integral characterization

The integral characterization (7.11) of the principal solution of (0.1) reduces to the usual integral characterization of the principal solution of linear equation (7.1) if $p = 2$. However, this characterization applies in case $p > 2$ only to solutions x for which $x'(t) \neq 0$ eventually. Moreover, in [36,37] examples of half-linear equations are given which show that if assumptions of the parts (iii) and (iv) of Theorem 7.4 are violated, (7.11) is *no longer equivalent characterization* of the principal solution of (0.1). For this reason, another integral characterization was suggested and the following statement is proved. The proof of this statement can be found in the above mentioned [36,37].

THEOREM 7.5. *Suppose that either*

(i) $c(t) < 0$ for large t , or

(ii) $c(t) > 0$ for large t and both integrals $\int^{\infty} r^{1-q}(t) dt, \int^{\infty} c(t) dt$ are convergent.

Then a solution \tilde{x} of (0.1) is principal if and only if

$$\int^{\infty} \frac{dt}{r^{q-1}(t)\tilde{x}^2(t)} = \infty. \tag{7.14}$$

7.8. Limit characterization of the principal solution

The “most characteristic” property of the principal solution in the linear case is the limit characterization (7.2). It was proved in the above mentioned papers [36,37] that this limit characterization extends under the assumption that $c(t) \neq 0$ eventually also to half-linear equation (0.1). This statement has been proved in [36] in case $c(t) < 0$ and in [37] for $c(t) > 0$.

THEOREM 7.6. *Suppose that (0.1) is nonoscillatory and $c(t) \neq 0$ for large t . Then a solution \tilde{x} is principal if and only if the limit characterization (7.2) holds for every solution x linearly independent of \tilde{x} .*

PROOF. The proof is based on the detailed asymptotic analysis of solutions of (0.1) made in the previous section. Since this analysis is rather complicated, we refer to the above mentioned papers [36,37] for details. \square

8. Conjugacy and disconjugacy of half-linear equations

Recall that similarly as in case of linear equations, Equation (0.1) is said to be *disconjugate* in a given interval I if every nontrivial solution of this equation has at most one zero in I , in the opposite case, i.e., if there exists a nontrivial solution of (0.1) having at least two zeros in I , Equation (0.1) is said to be *conjugate* in I .

In this section we will present criteria for conjugacy and disconjugacy of equation (0.1). Some theoretical criteria of this kind have been already formulated in the previous sections and are essentially involved in the Theorem 2.2. For example, the existence of a solution w of Riccati equation (2.1) associated with (0.1) is a sufficient condition for disconjugacy of this equation in the interval of the existence of this solution w . Another criteria can be formulated as consequences of the Sturmian comparison theorem.

8.1. Leighton's conjugacy criterion

Consider a pair of half-linear differential equations (0.1) and (2.13). If (2.13) is a Sturmian minorant of (0.1) on $I = [a, b]$ and (2.13) is conjugate on this interval, then majorant equation (0.1) is conjugate on $[a, b]$ as well. In the next theorem we replace the pointwise comparison of coefficients by the integral one. In the linear case $p = 2$ this statement was proved by Leighton [147], the half-linear version of this statement given here can be found in [115].

THEOREM 8.1. *Suppose that points a, b are conjugate relative to (2.13) and let y be a nontrivial solution of this equation for which $y(a) = 0 = y(b)$. If*

$$\mathcal{J}(y; a, b) := \int_a^b [(r(t) - R(t))|y'|^p - (c(t) - C(t))|y|^p] dt \leq 0, \quad (8.1)$$

then (0.1) is also conjugate in $[a, b]$.

PROOF. We have (with the notation introduced in Theorem 2.2)

$$\begin{aligned} \mathcal{F}(y; a, b) &= \int_a^b [r(t)|y'|^p - c(t)|y|^p] dt \\ &= \int_a^b [R(t)|y'|^p - C(t)|y|^p] dt + \mathcal{J}(y; a, b) \\ &= [R(t)y\Phi(y')]_a^b - \int_a^b y[(R(t)\Phi(y'))' - C(t)\Phi(y)] dt \\ &\quad + \mathcal{J}(y; a, b) \\ &= \mathcal{J}(y; a, b) \leq 0, \end{aligned}$$

hence (0.1) is conjugate on $[a, b]$ by Theorem 2.2. □

8.2. Singular Leighton’s theorem

In this subsection we show that if the points a, b are singular points of considered equations, in particular, $a = -\infty, b = \infty$ (or finite singularities, i.e., points where the unique solvability is violated), Leighton-type comparison theorem still holds if we replace the solution satisfying $y(a) = 0 = y(b)$ by the principal solution at a and b . We formulate the statement in a simplified form, as can be found in [59], a more general formulation is presented in [67].

THEOREM 8.2. *Suppose that \tilde{c} is a continuous function such that the equation*

$$(r(t)\Phi(y'))' + \tilde{c}(t)\Phi(y) = 0 \tag{8.2}$$

has the property that the principal solutions at a and b coincide and denote by h this simultaneous principal solution at these points. If

$$\liminf_{s_1 \downarrow a, s_2 \uparrow b} \int_{s_1}^{s_2} (c(t) - \tilde{c}(t))|h(t)|^p dt \geq 0, \quad c(t) \not\equiv \tilde{c}(t) \text{ in } (a, b), \tag{8.3}$$

then (0.1) is conjugate in $I = (a, b)$, i.e., there exists a nontrivial solution of this equation having at least two zeros in I .

PROOF. Our proof is based on the relationship between nonpositivity of the energy functional \mathcal{F} and conjugacy of (0.1) given in Theorem 2.2. We construct a nontrivial function piecewise of the class C^1 , with a compact support in I , such that $\mathcal{F}(y; a, b) < 0$.

Continuity of the functions c, \tilde{c} and (8.3) imply the existence of $\bar{t} \in I$ and $d, \varrho > 0$ such that $(c(t) - \tilde{c}(t))|h(t)|^p > d$ for $(\bar{t} - \varrho, \bar{t} + \varrho)$. Let Δ be any positive differentiable function

with the compact support in $(\bar{t} - \varrho, \bar{t} + \varrho)$. Further, let $a < t_0 < t_1 < \bar{t} - \varrho < \bar{t} + \varrho < t_2 < t_3 < b$ and let f, g be the solutions of (8.2) satisfying the boundary conditions

$$f(t_0) = 0, \quad f(t_1) = h(t_1), \quad g(t_2) = h(t_2), \quad g(t_3) = 0.$$

Note that such solutions exist if t_0, t_1 and t_2, t_3 are sufficiently close to a and b , respectively, due to nonoscillation of (8.2) near a and b (this is implied by the existence of principal solutions at these points) and the fact that the solution space of this equation is homogeneous. Define the function y as follows

$$y(t) = \begin{cases} 0, & t \in (a, t_0], \\ f(t), & t \in [t_0, t_1], \\ h(t), & t \in [t_1, t_2] \setminus [\bar{t} - \varrho, \bar{t} + \varrho], \\ h(t)(1 + \delta \Delta(t)), & t \in [\bar{t} - \varrho, \bar{t} + \varrho], \\ g(t), & t \in [t_2, t_3], \\ 0, & t \in [t_3, b), \end{cases}$$

where δ is a real parameter. Then we have

$$\begin{aligned} \mathcal{F}(y; t_0, t_3) &= \int_{t_0}^{t_3} [r(t)|y'|^p - c(t)|y|^p] dt \\ &= \int_{t_0}^{t_3} [r(t)|y'|^p - \tilde{c}(t)|y|^p] dt - \int_{t_0}^{t_3} [c(t) - \tilde{c}(t)]|y|^p dt \\ &= \int_{t_0}^{t_1} [r(t)|f'|^p - \tilde{c}(t)|f|^p] dt - \int_{t_0}^{t_1} [c(t) - \tilde{c}(t)]|f|^p dt \\ &\quad + \int_{t_1}^{t_2} [r(t)|y'|^p - \tilde{c}(t)|y|^p] dt - \int_{t_1}^{t_2} [c(t) - \tilde{c}(t)]|y|^p dt \\ &\quad + \int_{t_2}^{t_3} [r(t)|g'|^p - \tilde{c}(t)|g|^p] dt - \int_{t_2}^{t_3} [c(t) - \tilde{c}(t)]|g|^p dt. \end{aligned}$$

Denote by w_f, w_g, w_h the solutions of the Riccati equation associated with (8.2)

$$w' + \tilde{c}(t) + (p - 1)r^{1-q}(t)|w|^q = 0 \tag{8.4}$$

generated by f, g and h , respectively, i.e.,

$$w_f = \frac{r\Phi(f')}{\Phi(f)}, \quad w_g = \frac{r\Phi(g')}{\Phi(g)}, \quad w_h = \frac{r\Phi(h')}{\Phi(h)}.$$

Then using Picone's identity (2.7)

$$\int_{t_0}^{t_1} [r(t)|f'|^p - \tilde{c}(t)|f|^p] dt$$

$$\begin{aligned}
 &= w_f |f|^p \Big|_{t_0}^{t_1} + p \int_{t_0}^{t_1} r^{1-q}(t) P(r^{q-1} f', \Phi(f) w_f) dt \\
 &= w_f |f|^p \Big|_{t_0}^{t_1},
 \end{aligned}$$

where $P(u, v) = \frac{|u|^p}{p} - uv + \frac{|v|^q}{q}$ (see Section 2.2). Similarly,

$$\int_{t_2}^{t_3} [r(t)|g'|^p - \tilde{c}(t)|g|^p] dt = w_g |g|^p \Big|_{t_2}^{t_3}.$$

Concerning the interval $[t_1, t_2]$, we have (again by identity (2.7))

$$\begin{aligned}
 \tilde{\mathcal{F}}(y; t_1, t_2) &= \int_{t_1}^{t_2} [r(t)|y'|^p - \tilde{c}(t)|y|^p] dt \\
 &= w_h |h|^p \Big|_{t_1}^{t_2} + p \int_{t_1}^{t_2} r^{1-q}(t) P(r^{q-1} y', \Phi(y) w_h) dt \\
 &= w_h |h|^p \Big|_{t_1}^{t_2} + \int_{\bar{t}-\varrho}^{\bar{t}+\varrho} \left\{ r(t) |h' + \delta(\Delta h)'|^p \right. \\
 &\quad \left. - pr(t) \frac{\Phi(h')}{\Phi(h)} y' h^{p-1} (1 + \delta\Delta)^{p-1} \right. \\
 &\quad \left. + (p-1)r^{1-q}(t) \left| \frac{r(t)\Phi(h')}{\Phi(h)} \right|^q h^p (1 + \delta\Delta)^p \right\} dt \\
 &= w_h |h|^p \Big|_{t_1}^{t_2} + \int_{\bar{t}-\varrho}^{\bar{t}+\varrho} r(t) \{ |h'|^p + p\delta(\Delta h)' \Phi(h') + o(\delta) \\
 &\quad - p(h' + \delta(\Delta h)') \Phi(h') (1 + (p-1)\delta\Delta + o(\delta)) \\
 &\quad + (p-1)|h'|^p (1 + p\delta\Delta + o(\delta)) \} dt \\
 &= w_h |h|^p \Big|_{t_1}^{t_2} + \int_{\bar{t}-\varrho}^{\bar{t}+\varrho} r(t) \{ |h'|^p + p\delta(\Delta h)' \Phi(h') + p|h'|^p \\
 &\quad - p\delta\Phi(h')(\Delta h)' - p(p-1)\delta\Delta|h'|^p + (p-1)|h'|^p \\
 &\quad + (p-1)p\delta\Delta|h'|^p + o(\delta) \} dt \\
 &= w_h |h|^p \Big|_{t_1}^{t_2} + o(\delta).
 \end{aligned}$$

Consequently,

$$\begin{aligned}
 \tilde{\mathcal{F}}(y; t_0, t_3) &= \int_{t_0}^{t_3} [r(t)|y'|^p - \tilde{c}(t)|y|^p] dt \\
 &= w_f |f|^p \Big|_{t_0}^{t_1} + w_h |h|^p \Big|_{t_1}^{t_2} + w_g |g|^p \Big|_{t_2}^{t_3} + o(\delta) \\
 &= |h(t_1)|^p (w_f(t_1) - w_h(t_1)) + |h(t_2)|^p (w_h(t_2) - w_g(t_2)) + o(\delta)
 \end{aligned}$$

as $\delta \rightarrow 0+$.

Further, observe that the function $\frac{f}{h}$ is monotonically increasing in (t_0, t_1) since $\frac{f}{h}(t_0) = 0$, $\frac{f}{h}(t_1) = 1$ and $(\frac{f}{h})' = \frac{f'h - fh'}{h^2} \neq 0$ in (t_0, t_1) . Indeed, if $f'h - fh' = 0$ at some point $\tilde{t} \in (t_0, t_1)$, i.e., $\frac{f'}{f}(\tilde{t}) = \frac{h'}{h}(\tilde{t})$ then $w_f(\tilde{t}) = w_h(\tilde{t})$ which contradicts the unique solvability of the generalized Riccati equation. By the second mean value theorem of integral calculus there exists $\xi_1 \in (t_0, t_1)$ such that

$$\begin{aligned} \int_{t_0}^{t_1} (c(t) - \tilde{c}(t))|f|^p dt &= \int_{t_0}^{t_1} (c(t) - \tilde{c}(t))|h|^p \frac{|f|^p}{|h|^p} dt \\ &= \int_{\xi_1}^{t_1} (c(t) - \tilde{c}(t))|h|^p dt. \end{aligned}$$

By the same argument the function $\frac{g}{h}$ is monotonically decreasing in (t_2, t_3) and

$$\int_{t_2}^{t_3} (c(t) - \tilde{c}(t))|g|^p dt = \int_{t_2}^{\xi_2} (c(t) - \tilde{c}(t))|h|^p dt$$

for some $\xi_2 \in (t_2, t_3)$.

Concerning the interval (t_1, t_2) we have

$$\begin{aligned} &\int_{t_1}^{t_2} (c(t) - \tilde{c}(t))|y|^p dt \\ &= \int_{t_1}^{\tilde{t}-\varrho} (c(t) - \tilde{c}(t))|h|^p dt \\ &\quad + \int_{\tilde{t}-\varrho}^{\tilde{t}+\varrho} (c(t) - \tilde{c}(t))|h|^p (1 + \delta\Delta)^p dt + \int_{\tilde{t}+\varrho}^{t_2} (c(t) - \tilde{c}(t))|h|^p dt \\ &= \int_{t_1}^{t_2} (c(t) - \tilde{c}(t))|h|^p dt + \delta \int_{\tilde{t}-\varrho}^{\tilde{t}+\varrho} (c(t) - \tilde{c}(t))|h|^p \Delta(t) dt + o(\delta) \\ &\geq \int_{t_1}^{t_2} (c(t) - \tilde{c}(t))|h|^p dt + \delta K + o(\delta), \end{aligned}$$

where $K = d \int_{\tilde{t}-\varrho}^{\tilde{t}+\varrho} \Delta(t) dt > 0$. Therefore

$$\int_{t_0}^{t_3} (c(t) - \tilde{c}(t))|y|^p dt \geq \int_{\xi_1}^{\xi_2} (c(t) - \tilde{c}(t))|h|^p dt + K\delta + o(\delta).$$

Summarizing our computations, we have

$$\begin{aligned} \mathcal{F}(y; t_0, t_3) &\leq |h(t_1)|^p (w_f(t_1) - w_h(t_1)) + |h(t_2)|^p (w_h(t_2) - w_g(t_2)) \\ &\quad - \int_{\xi_1}^{\xi_2} (c(t) - \tilde{c}(t))|h|^p dt - (K\delta + o(\delta)) \end{aligned}$$

with a positive constant K .

Now, let $\delta > 0$ (sufficiently small) be such that $K\delta + o(\delta) =: \varepsilon > 0$. According to (8.3) the points t_1, t_2 can be chosen in such a way that

$$\int_{s_1}^{s_2} (c(t) - \tilde{c}(t))|h|^p dt > -\frac{\varepsilon}{4}$$

whenever $s_1 \in (a, t_1), s_2 \in (t_2, b)$. Further, since w_h is generated by the solution h of (8.2) which is principal both at $t = a$ and $t = b$, according to the Mirzov construction of the principal solution, we have (for t_1, t_2 fixed for a moment)

$$\lim_{t_0 \rightarrow a^+} [w_f(t_1) - w_h(t_1)] = 0, \quad \lim_{t_3 \rightarrow b^-} [w_g(t_2) - w_h(t_2)] = 0.$$

Hence

$$|h(t_1)|^p [w_f(t_1) - w_h(t_1)] < \frac{\varepsilon}{4}, \quad |h(t_2)|^p [w_h(t_2) - w_g(t_2)] < \frac{\varepsilon}{4}$$

if $t_0 < t_1, t_3 > t_2$ are sufficiently close to a and b , respectively.

Consequently, for the above specified choice of $t_0 < t_1 < t_2 < t_3$ we have

$$\begin{aligned} \mathcal{F}(y; t_0, t_3) &= \int_{t_0}^{t_3} [r(t)|y'|^p - \tilde{c}(t)|y|^p] dt - \int_{t_0}^{t_3} (c(t) - \tilde{c}(t))|y|^p dt \\ &\leq |h(t_1)|^p [w_f(t_1) - w_h(t_1)] + |h(t_2)|^p [w_h(t_2) - w_g(t_2)] \\ &\quad - \int_{\xi_1}^{\xi_2} (c(t) - \tilde{c}(t))|h|^p dt - (K\delta + o(\delta)) \\ &< \frac{\varepsilon}{4} + \frac{\varepsilon}{4} + \frac{\varepsilon}{4} - \varepsilon < 0. \end{aligned}$$

The proof is now complete. □

8.3. Lyapunov inequality

The classical Lyapunov inequality (see, e.g., [106, Chapter XI]) for the linear differential equation (1.1) states that if $a, b, a < b$, are consecutive zeros of a nontrivial solution of this equation, then

$$\int_a^b c_+(t) dt > \frac{4}{\int_a^b r^{-1}(t) dt}, \quad c_+(t) = \max\{0, c(t)\}.$$

This inequality has been extended in many directions and its half-linear extension reads as follows, see [85].

THEOREM 8.3. Let $a, b, a < b$, be consecutive zeros of a nontrivial solution of (0.1). Then

$$\int_a^b c_+(t) dt > \frac{2^p}{\left(\int_a^b r^{1-q}(t) dt\right)^{p-1}}. \quad (8.5)$$

PROOF. According to homogeneity of the solution space of (0.1), we can suppose that $x(t) > 0$ on (a, b) . Let $c \in (a, b)$ be the least point of the local maximum of x in (a, b) , i.e., $x'(c) = 0$ and $x'(t) > 0$ on $[a, c)$. By the Hölder inequality we have

$$\begin{aligned} x^p(c) &= \left(\int_a^c x'(t) dt\right)^p = \left(\int_a^c r^{-\frac{1}{p}}(t)r^{\frac{1}{p}}(t)x'(t) dt\right)^p \\ &\leq \left(\int_a^c r^{-\frac{q}{p}}(t) dt\right)^{\frac{p}{q}} \left(\int_a^c r(t)(x'(t))^p dt\right). \end{aligned}$$

Multiplying (0.1) by $x(t)$ and integrating from a to c by parts we get

$$\begin{aligned} \int_a^c r(t)(x'(t))^p dt &= \int_a^c c(t)x^p(t) dt \leq \int_a^c c_+(t)x^p(t) dt \\ &\leq x^p(c) \int_a^c c_+(t) dt, \end{aligned}$$

hence

$$x^p(c) \leq \left(\int_a^c r^{1-q}(t) dt\right)^{p-1} \left(\int_a^c c_+(t) dt\right) x^p(c),$$

which yields

$$\left(\int_a^c r^{1-q}(t) dt\right)^{1-p} \leq \int_a^c c_+(t) dt.$$

Similarly, if d is the greatest point of local maximum of x in (a, b) , i.e., $x'(d) = 0$ and $x'(t) < 0$ on (d, b) , we have

$$\left(\int_d^b r^{1-q}(t) dt\right)^{1-p} \leq \int_d^b c_+(t) dt.$$

Consequently,

$$\int_a^b c_+(t) dt \geq \left(\int_a^c r^{1-q}(t) dt\right)^{1-p} + \left(\int_d^b r^{1-q}(t) dt\right)^{1-p}.$$

Finally, since the function $f(u) = u^{1-p}$ is convex for $u > 0$, the Jensen inequality $f(\frac{u+v}{2}) \leq \frac{1}{2}[f(u) + f(v)]$ with $u = \int_a^c r^{1-q}(t) dt$, $v = \int_d^b r^{1-q}(t) dt$ implies

$$\begin{aligned} & \left(\int_a^c r^{1-q}(t) dt \right)^{1-p} + \left(\int_d^b r^{1-q}(t) dt \right)^{1-p} \\ & \geq 2 \left[\frac{1}{2} \left(\int_a^c r^{1-q}(t) dt + \int_d^b r^{1-q}(t) dt \right) \right]^{1-p} \\ & \geq \frac{2^p}{\left(\int_a^b r^{1-q}(t) dt \right)^{p-1}}, \end{aligned}$$

what completes the proof. □

REMARK 8.1. Note that the Lyapunov-type inequality was proved for the first time in [85] for (0.1) with $r(t) \equiv 1$, but the extension to general (0.1) is straightforward. Half-linear Lyapunov inequality has been rediscovered in several later papers, e.g., in [154,224].

8.4. Vallée Poussin-type inequality

Another important inequality concerning disconjugacy of the linear differential equation

$$x'' + a(t)x' + b(t)x = 0 \tag{8.6}$$

was introduced by Vallée Poussin [214] in 1929 and reads as follows. Suppose that $t_1 < t_2$ are consecutive zeros of a nontrivial solution x of (8.6), then

$$2 \int_0^\infty \frac{dt}{t^2 + At + B} \leq t_2 - t_1, \quad A := \max_{t \in [t_1, t_2]} |a(t)|, \quad B := \max_{t \in [a, b]} |b(t)|.$$

The half-linear version of this criterion can be found in [68]. Here we formulate this criterion in a simplified form, to underline similarity with the original criterion of Vallée Poussin. For the same reason we consider the equation

$$(\Phi(x'))' + a(t)\Phi(x') + b(t)\Phi(x) = 0 \tag{8.7}$$

instead of (0.1) (if the function r in (0.1) is differentiable, then this equation can be easily reduced to (8.7)).

THEOREM 8.4. *Suppose that $t_1 < t_2$ are consecutive zeros of a nontrivial solution x of (8.7). Then*

$$2 \int_0^\infty \frac{dt}{(p-1)t^q + At + B} \leq t_2 - t_1, \quad A = \max_{t \in [t_1, t_2]} |a(t)|, \quad B = \max_{t \in [t_1, t_2]} |b(t)|. \tag{8.8}$$

PROOF. Suppose that $x(t) > 0$ in (t_1, t_2) , in case $x(t) < 0$ in (t_1, t_2) the proof is analogical. Let $c, d \in (t_1, t_2)$, $c \leq d$, be the least and the greatest points of the local maximum of x in (a, b) , respectively, i.e., $x'(t) > 0$ for $t \in (t_1, c)$, $x'(t) < 0$ for $t \in (d, t_2)$ and $x'(c) = 0 = x'(d)$. The Riccati variable $v = \frac{\Phi(x')}{\Phi(x)}$ satisfies $v(t_1+) = \infty$, $v(c) = 0$, $v(t) > 0$, $t \in (t_1, c)$ and

$$v' = -b(t) - a(t)v - (p - 1)v^q \geq -B - Av - (p - 1)v^q. \tag{8.9}$$

Hence,

$$\int_0^\infty \frac{dv}{(p - 1)v^q + Av + B} \leq c - t_1. \tag{8.10}$$

Concerning the interval (d, t_2) , we set $v = -\frac{\Phi(x')}{\Phi(x)} > 0$ for $t \in (d, t_2)$ and similarly as for $t \in (t_1, c)$ we have

$$\int_0^\infty \frac{dv}{(p - 1)v^q + Av + B} \leq t_2 - d. \tag{8.11}$$

The summation of (8.10) and (8.11) gives

$$2 \int_0^\infty \frac{dv}{(p - 1)v^q + Av + B} \leq c - t_1 + t_2 - d \leq t_2 - t_1,$$

what we needed to prove. □

REMARK 8.2. (i) Since (8.8) is a necessary condition for conjugacy of (8.7) in $[t_1, t_2]$, the opposite inequality is a disconjugacy criterion: if

$$2 \int_0^\infty \frac{dv}{(p - 1)v^q + Av + B} > t_2 - t_1,$$

then (8.7) is disconjugate in $[t_1, t_2]$.

(ii) A more general Riccati substitution $v = \alpha(t) \frac{\Phi(x')}{\Phi(x)}$, $t \in (t_1, c]$, $v = -\beta(t) \frac{\Phi(x')}{\Phi(x)}$, $t \in [d, t_2)$, where α, β are suitable positive functions, enables to formulate the Vallée Poussin-type criterion in a more general form than presented in Theorem 8.4, we refer to [68] for details. Concerning the various extensions of the linear Vallée Poussin criterion we refer to the survey paper [14] and the references given therein.

8.5. Focal point criteria

Recall that a point b is said to be the *first right focal point* of $c < b$ with respect to (0.1) if there exists a nontrivial solution x of this equation such that $x'(c) = 0 = x(b)$ and $x(t) \neq 0$ for $t \in [c, b)$. The first left focal point a of c is defined similarly by $x(a) = 0 = x'(c)$,

$x(t) \neq 0$ on $(a, c]$. Equation (0.1) is said to be *right disfocal* on $[c, b)$ if there exists no right focal point of c relative to (0.1) in (c, b) , the *left disfocality* on $(a, c]$ is defined in a similar way. Consequently, (0.1) is conjugate on an interval (a, b) if there exists $c \in (a, b)$ such that this equation is neither right disfocal on $[c, b)$ nor left disfocal on $(a, c]$. This idea is illustrated in the next statement for (6.16) considered on $(a, b) = (-\infty, \infty)$, see [65]. The extension of this statement to general half-linear equation (0.1) is immediate.

THEOREM 8.5. *Suppose that the function $c(t) \neq 0$ for $t \in (0, \infty)$ and there exist constants $\alpha \in (-\frac{1}{p}, p - 2]$ and $T \geq 0$ such that*

$$\int_0^t s^\alpha \left(\int_0^s c(\tau) d\tau \right) ds \geq 0 \quad \text{for } t \geq T. \tag{8.12}$$

Then the solution x of (6.16) satisfying the initial conditions $x(0) = 1, x'(0) \leq 0$ has a zero in $(0, \infty)$.

PROOF. Suppose, by contradiction, that the solution x has no zero on $(0, \infty)$, i.e., $x(t) > 0$. Let $w = -\frac{\Phi(x')}{\Phi(x)}$ be the solution of the Riccati equation

$$w' = c(t) + (p - 1)r^{1-q}(y)|w|^q.$$

Since $w(0) \geq 0$, we have

$$\begin{aligned} w(t) &= w(0) + \int_0^t c(s) ds + (p - 1) \int_0^t |w(s)|^q ds \\ &\geq \int_0^t c(s) ds + (p - 1) \int_0^t |w(s)|^q ds \end{aligned} \tag{8.13}$$

and

$$\int_0^t s^\alpha w(s) ds \geq \int_0^t \left(s^\alpha \int_0^s c(\tau) d\tau \right) ds + G(t),$$

where

$$G(t) = (p - 1) \int_0^t s^\alpha \left(\int_0^s |w(\tau)|^q d\tau \right) ds.$$

Then

$$G'(t) = (p - 1)t^\alpha \int_0^t |w(\tau)|^q d\tau \geq 0 \quad \text{for } t \geq 0 \tag{8.14}$$

and according to (8.12)

$$G(t) \leq \int_0^t s^\alpha w(s) ds \quad \text{for } t \geq T. \tag{8.15}$$

By the Hölder inequality we have

$$\begin{aligned} \int_0^t s^\alpha w(s) \, ds &\leq \left[\int_0^t s^{p\alpha} \, ds \right]^{\frac{1}{p}} \left[\int_0^t |w(s)|^q \, ds \right]^{\frac{1}{q}} \\ &= \left[\frac{t^{1+p\alpha}}{1+p\alpha} \right]^{\frac{1}{p}} \left[\int_0^t |w(s)|^q \, ds \right]^{\frac{1}{q}}, \end{aligned}$$

hence by (8.15)

$$\frac{t^{(1+p\alpha)\frac{q}{p}}}{(1+p\alpha)^{\frac{q}{p}}} \int_0^t |w(s)|^q \, ds \geq G^q(t).$$

Here we need the relation $G(t) > 0$ for sufficiently large t . By (8.14) $G(t)$ is nondecreasing function of t and $G(0) = 0$. The equality $G(t) = 0$ for all $t \geq 0$ would imply that $w(t) \equiv 0$, consequently by (8.14) $x'(t) \equiv 0$ for $t \geq 0$. But this may happen only if $c(t) \equiv 0$, which case has been excluded. Hence we may suppose that T is already chosen so large that the inequality $G(t) > 0$ holds for $t \geq T$.

Denote $\beta = \alpha - (1+p\alpha)\frac{q}{p}$ and $K = (p-1)(1+p\alpha)^{\frac{q}{p}} > 0$. Then by (8.14) the last inequality yields $G'G^{-q} \geq Kt^\beta$. Integrating this inequality from T to t , we get

$$\frac{1}{q-1}G^{1-q}(T) > \frac{1}{q-1}[G^{1-q}(T) - G^{1-q}(t)] \geq K \int_T^t s^\beta \, ds,$$

where the integral on the right-hand side tends to ∞ as $t \rightarrow \infty$ because an easy computation shows that $\alpha \leq p-2$ implies $\beta \geq -1$. This contradiction proves that x must have a positive zero. □

REMARK 8.3. (i) Clearly, in Theorem 8.5 the starting point $t_0 = 0$ can be shifted to any other value $t_0 \in \mathbb{R}$ if the condition (2.4) is modified to

$$\int_{t_0}^t (s-t_0)^\alpha \left(\int_{t_0}^s c(\tau) \, d\tau \right) ds \geq 0 \quad \text{for } t \geq T \geq t_0.$$

A similar statement can be formulated on the interval $(-\infty, t_0)$, too.

(ii) In the previous theorem we have used the weight function s^α , $\alpha \in (-\frac{1}{p}, p-2]$. The results of Section 9.2 of the next chapter suggest to use a more general weight functions. This research is a subject of the present investigation. The same remark essentially concerns also the results of Section 9.5.

Using the just established focal point criterion we can prove the following conjugacy criterion for (6.16).

THEOREM 8.6. *Suppose that $c(t) \not\equiv 0$ both in $(-\infty, 0)$ and $(0, \infty)$ and there exist constants $\alpha_1, \alpha_2 \in (-\frac{1}{p}, p - 2]$ and $T_1, T_2 \in \mathbb{R}, T_1 < 0 < T_2$, such that*

$$\int_t^0 |s|^{\alpha_1} \left(\int_s^0 c(\tau) d\tau \right) ds \geq 0, \quad t \leq T_1,$$

$$\int_0^t s^{\alpha_2} \left(\int_0^s c(\tau) d\tau \right) ds \geq 0, \quad t \geq T_2. \tag{8.16}$$

Then Equation (6.16) is conjugate in \mathbb{R} , more precisely, there exists a solution of (6.16) having at least one positive and one negative zero.

PROOF. The statement follows immediately from Theorem 8.5 since by this theorem the solution x given by $x(0) = 1, x'(0) = 0$ has a positive zero. Using the same argument as in Theorem 8.5 and the second condition in (8.16) we can show the existence of a negative zero. □

REMARK 8.4. (i) Assumptions of the previous theorem are satisfied if

$$\liminf_{s_1 \downarrow -\infty, s_2 \uparrow \infty} \int_{s_1}^{s_2} c(t) dt > 0. \tag{8.17}$$

This conjugacy criterion for the linear Sturm–Liouville equation (1.1) with $r(t) \equiv 1$ is proved in [212] and the extension to (6.16) can be found in [188].

(ii) Several conjugacy criteria for linear equation (1.1) (in terms of its coefficients r, c) are proved using the fact that this equation is conjugate on (a, b) if and only if

$$\int_a^b \frac{dt}{r(t)[x_1^2(t) + x_2^2(t)]} > \pi \tag{8.18}$$

for any pair of solutions of (1.1) for which $r(x'_1 x_2 - x_1 x'_2) \equiv \pm 1$. This statement is based on the trigonometric transformation of (1.1), see [55,56] and also Section 3. However, since we have in disposal no half-linear analogue of the trigonometric transformation, conjugacy criteria of this kind for (0.1) are (till now) missing.

8.6. Lyapunov-type focal points and conjugacy criteria

The results of this section can be found in [111,188] and concern again equation (6.16).

THEOREM 8.7. *Let x be a nontrivial solution of (6.16) satisfying $x'(d) = 0 = x(b)$ and $x(t) \neq 0$ for $t \in [d, b)$. Then*

$$(b - d)^{p-1} \sup_{d \leq t \leq b} \left| \int_d^t c(s) ds \right| > 1. \tag{8.19}$$

Moreover, if there is no extreme value of x in (d, b) , then

$$(b - d)^{p-1} \sup_{d \leq t \leq b} \int_d^t c(s) \, ds > 1. \tag{8.20}$$

PROOF. Suppose that $x(t) > 0$ on $[d, b)$, if $x(t) < 0$ we proceed in the same way. Let $v = -\frac{\Phi(x')}{\Phi(x)}$ and $V(t) = (p - 1) \int_d^t |v(s)|^q \, ds$. Then we have

$$v(t) = \int_d^t c(s) \, ds + V(t). \tag{8.21}$$

Thus, $v(d) = 0 = V(d)$ and $\lim_{t \rightarrow b-} v(t) = \lim_{t \rightarrow b-} V(t) = \infty$. Set

$$C^* := \sup_{d \leq t \leq b} \left| \int_d^t c(s) \, ds \right|$$

and observe that $|v(t)| \leq C^* + V(t)$, so that

$$V'(t) = (p - 1)|v(t)|^q \leq (p - 1)(C^* + V(t))^q,$$

and

$$\frac{V'(t)}{(p - 1)(C^* + V(t))^q} \leq 1.$$

Integrating this inequality from d to b and using $\lim_{t \rightarrow b-} V(t) = \infty$, we obtain

$$-\frac{1}{(C^* + V(t))^{q-1}} \Big|_d^b \leq b - d,$$

which implies that $(b - d)^{p-1} C^* \leq 1$. We remark that the equality cannot hold, for otherwise $|C(t)| = |\int_d^t c(s) \, ds| = C^*$ on $[d, b)$ which implies that $c(t) \equiv 0$, a contradiction, thus (8.19) holds.

If d is the largest extreme point of x in (a, b) , then $x'(t) \leq 0$ and hence $v(t) \geq 0$ on $[d, b)$. Set $C_* = \sup_{d \leq t \leq b} \int_d^t c(s) \, ds$. Then we also have $C_* > 0$ since the assumption $C_* \leq 0$ contradicts to $V(d) = 0$, $\lim_{t \rightarrow b-} V(t) = \infty$. Hence, by (8.21), $0 \leq v(t) \leq C_* + V(t)$. The remaining part of the proof is similar to the first one. \square

REMARK 8.5. (i) Similarly as above, if $a < c$, $x(a) = 0 = x'(c)$ and $x(t) \neq 0$ on $(a, c]$, we have

$$(c - a)^{p-1} \sup_{a \leq t \leq c} \left| \int_t^c c(s) \, ds \right| > 1.$$

(ii) Combining Theorem 8.7 with the previous part of the remark one can prove that if $a < b$ are consecutive zeros of a nontrivial solution x of (6.16), then there exist two disjoint subintervals $I_1, I_2 \subset [a, b]$ such that

$$(b-a)^{p-1} \int_{I_1 \cup I_2} c(s) \, ds \geq \min\{4, 4^{p-1}\}, \quad \int_{[a,b] \setminus (I_1 \cup I_2)} c(s) \, ds \leq 0.$$

For details and related (dis)conjugacy criteria we refer to [111].

Oscillatory Equations

In this chapter we start with oscillation criteria for half-linear equation (0.1). Some basic oscillation criteria have already been formulated in previous chapters, here we focus our attention to “more advanced criteria”. By this we mean half-linear extensions of linear oscillation criteria which are not given in standard books on linear oscillation, e.g., in [208]. Section 10 is devoted to results which are not exactly oscillation criteria, but are closely related to oscillation theory. Section 11 deals with the half-linear Sturm–Liouville problem and the last section of this chapter, entitled “Perturbation principle”, presents a new method of the investigation of oscillatory properties of (0.1), where this equation is viewed as a perturbation of another equation of the same form.

9. Oscillation criteria

Similarly to nonoscillation criteria, the basic tools in proofs of oscillation criteria are the variational principle and the Riccati technique. However, as we will see in this and the next section, the Riccati technique is used more frequently.

9.1. General observations

In this section we present criteria which complete nonoscillation criteria given in Section 5. We start with some general observations.

(i) If $\int^{\infty} r^{1-q}(t) dt = \infty$ in (0.1), then this equation can be transformed into the equation

$$(\Phi(x'))' + c(t)\Phi(x) = 0 \quad (9.1)$$

and this transformation transforms the interval $[T, \infty)$ into an interval of the same form. For this reason, we will formulate sometimes our results for (9.1) (mainly in situations when these results were first established for (1.1) with $r(t) \equiv 1$ in linear case), the extension to (0.1) with $\int^{\infty} r^{1-q}(t) dt = \infty$ is then straightforward.

(ii) If we suppose that $c(t) > 0$ for large t in (9.1), the situation is considerably simpler than in the general case when c is allowed to change its sign. In case $c(t) > 0$, Equation (9.1) is the Sturmian majorant of the equation $(\Phi(x'))' = 0$ and the minimal solution of the associated Riccati equation

$$v' + (p-1)|v|^q = 0$$

is $v(t) \equiv 0$. This means, in view of Theorem 7.2, that the minimal solution of the Riccati equation

$$w' + c(t) + (p - 1)|w|^q = 0 \quad (9.2)$$

associated with (9.1) is positive and this implies that positive solutions of (9.1) are increasing. Consequently, in oscillation criteria for (9.1) proved via the Riccati technique, it is sufficient to impose such conditions on the function c that for any $T \in \mathbb{R}$ the solution given by $x(T) = 0$, $x'(T) > 0$ has eventually negative derivative $x'(t)$. Indeed, this means that the associated solution of (9.2) is eventually negative, hence less than minimal solution which is nonnegative (compare Theorem 7.2 and Corollary 7.1) and hence cannot be extensible up to ∞ which implies that x has a zero point in $[T, \infty)$.

9.2. Coles-type criteria

The results of this subsection are taken from the paper [153] and concern the half-linear extension of the averaging technique introduced in the linear case by Coles in [46]. The results are formulated for (9.1).

Let \mathcal{J} be the class of nonnegative locally integrable functions f defined on $[0, \infty)$ and satisfying the condition

$$\limsup_{t \rightarrow \infty} \left(\int_0^t f(s) \, ds \right)^{q-1-\mu} [F_\mu(\infty) - F_\mu(t)] > 0 \quad (9.3)$$

for some $\mu \in [0, q - 1)$, where

$$F_\mu(t) = \int_0^t f(s) \frac{\left(\int_0^s f(\xi) \, d\xi \right)^\mu}{\left(\int_0^s f^p(\xi) \, d\xi \right)^{q-1}} \, ds.$$

If $F_\mu(\infty) = \infty$, then $f \in \mathcal{J}$. Let \mathcal{J}_0 be the subclass of \mathcal{J} consisting of nonnegative locally integrable functions f satisfying

$$\lim_{t \rightarrow \infty} \frac{\int_0^t f^p(s) \, ds}{\left(\int_0^t f(s) \, ds \right)^p} = 0. \quad (9.4)$$

Observe that if (9.3) or (9.4) holds, then

$$\int^\infty f(t) \, dt = \infty. \quad (9.5)$$

On the other hand, every bounded nonnegative locally integrable function satisfying (9.5) belongs to \mathcal{J}_0 and $\mathcal{J}_0 \subset \mathcal{J}$. Since all nonnegative polynomials are in \mathcal{J}_0 , this class of functions contains also unbounded functions. Elements of \mathcal{J} and \mathcal{J}_0 will be called *weight functions*.

For $f \in \mathcal{J}$, we define

$$A_f(s, t) := \frac{\int_s^t f(\tau) \int_s^\tau c(\mu) \, d\mu \, d\tau}{\int_s^t f(\tau) \, d\tau}.$$

The following statement reduces to the Hartman–Wintner theorem (Theorem 5.6) when the weight function f is $f(t) \equiv 1$.

THEOREM 9.1. *Suppose that (9.1) is nonoscillatory.*

(i) *If there exists $f \in \mathcal{J}$ such that for some $T \in \mathbb{R}$*

$$\liminf_{t \rightarrow \infty} A_f(T, t) > -\infty \tag{9.6}$$

then

$$\int_{\xi}^{\infty} |w(t)|^q \, dt < \infty \tag{9.7}$$

for every solution w of the associated Riccati equation (9.2).

(ii) *Assume that (9.7) holds for some solution w of (9.2). Then for every $f \in \mathcal{J}_0$ and $T \in \mathbb{R}$ sufficiently large $\lim_{t \rightarrow \infty} A_f(T, t)$ exists finite.*

PROOF. The proof of this statement copies essentially the proof of Theorem 5.6.

(i) Assume, by contradiction, that

$$\int_{\xi}^{\infty} |w(t)|^q \, dt = \infty \tag{9.8}$$

for some solution of (9.2). Integrating this equation from ξ to t , multiplying the obtained integral equation by $f(t)$ and then integrating again from ξ to t , we obtain

$$\begin{aligned} \int_{\xi}^t f(s)w(s) \, ds &= w(\xi) \int_{\xi}^t f(s) \, ds - \int_{\xi}^t f(s) \int_{\xi}^s c(\tau) \, d\tau \, ds \\ &\quad - (p-1) \int_{\xi}^t f(s) \int_{\xi}^s |w(\tau)|^q \, d\tau \, ds \\ &= w(\xi) \int_{\xi}^t f(s) \, ds - A_f(\xi, t) \int_{\xi}^t f(s) \, ds \\ &\quad - (p-1) \int_{\xi}^t f(s) \int_{\xi}^s |w(\tau)|^q \, d\tau \, ds \\ &= [w(\xi) - A_f(\xi, t)] \int_{\xi}^t f(s) \, ds \\ &\quad - (p-1) \int_{\xi}^t f(s) \int_{\xi}^s |w(\tau)|^q \, d\tau \, ds, \end{aligned}$$

where $t \geq \xi \geq T$. From (9.2) we have

$$w(\xi) = w(T) - \int_T^\xi c(s) ds - (p-1) \int_T^\xi |w(s)|^q ds.$$

Since $f \in \mathcal{J}$, (9.5) holds. This implies

$$\begin{aligned} A_f(\xi, t) &= \frac{\int_T^t f(s) ds}{\int_\xi^t f(s) ds} A_f(T, t) - \int_T^\xi c(s) ds - \frac{\int_T^\xi f(s) \int_T^s c(\tau) d\tau ds}{\int_\xi^t f(s) ds} \\ &= \frac{\int_T^t f(s) ds}{\int_\xi^t f(s) ds} A_f(T, t) - \int_T^\xi c(s) ds + o(1) \quad \text{as } t \rightarrow \infty. \end{aligned}$$

Thus

$$\begin{aligned} w(\xi) - A_f(\xi, t) &= w(T) - \frac{\int_T^t f(s) ds}{\int_\xi^t f(s) ds} A_f(T, t) \\ &\quad - (p-1) \int_T^t |w(s)|^q ds + o(1) \end{aligned} \quad (9.9)$$

as $t \rightarrow \infty$. Since $f \in \mathcal{J}$, there exists a positive number $\lambda > 0$ such that

$$\frac{\lambda^{1-q}}{p-1} < (q-1-\mu) \limsup_{t \rightarrow \infty} \left[\int^t f(s) ds \right]^{q-1-\mu} [F_\mu(\infty) - F_\mu(t)], \quad (9.10)$$

where μ is the same as in (9.3). It follows from (9.6), (9.8) and the previous computation that there exist two numbers a and b , $b \geq a \geq T$, such that

$$w(a) - A_f(a, t) \leq -\lambda \quad (9.11)$$

for $t \geq b$. Let $z(t) := \int_a^t f(s)w(s) ds$. Then the Hölder inequality implies

$$\int_a^t |w(\tau)|^q d\tau \geq \frac{|z(t)|^q}{\left(\int_a^t f^p(\tau) d\tau\right)^{q-1}}.$$

It follows from (9.9) and (9.11) that

$$\begin{aligned} z(t) &\leq -\lambda \int_a^t f(s) ds - (p-1) \int_a^t f(s) |z(s)|^q \left(\int_a^s f^p(\tau) d\tau \right)^{1-q} ds \\ &=: -G(t). \end{aligned} \quad (9.12)$$

Thus

$$G'(t) = \lambda f(t) + (p-1) f(t) |z(t)|^q \left(\int_a^t f^p(s) ds \right)^{1-q} \quad (9.13)$$

and

$$0 \leq \lambda \int_a^t f(s) \, ds \leq G(t) \leq |z(t)|. \tag{9.14}$$

It follows from (9.12), (9.13) and (9.14) that

$$\begin{aligned} G'(t)G^{\mu-q}(t) &\geq G'(t)G^\mu(t)|z(t)|^{-q} \\ &\geq (p-1)\lambda^\mu f(t) \left(\int_a^t f(s) \, ds \right)^\mu \left(\int_a^t f^p(s) \, ds \right)^{1-q}. \end{aligned}$$

Integrating this inequality from t ($t \geq b$) to ∞ , we get

$$\frac{1}{q-1-\mu} G^{\mu-q-1}(t) \geq (p-1)\lambda^\mu [F_\mu(\infty) - F_\mu(t)].$$

Inequality (9.14) then implies

$$\frac{\lambda^{1-q}}{p-1} \geq (q-1-\mu) \left[\int_a^t f(s) \, ds \right]^{q-1-\mu} [F_\mu(\infty) - F_\mu(t)]$$

which contradicts (9.10).

(ii) As in the previous part of the proof, (9.9) holds. This implies that

$$\begin{aligned} A_f(\xi, t) &= w(\xi) - \frac{\int_\xi^t f(s)w(s) \, ds}{\int_\xi^t f(s) \, ds} \\ &\quad - (p-1) \frac{\int_\xi^t f(s) \int_\xi^s |w(\tau)|^q \, d\tau \, ds}{\int_\xi^t f(s) \, ds}. \end{aligned} \tag{9.15}$$

Since $f \in \mathcal{J}_0$, (9.5) holds. Thus,

$$\lim_{t \rightarrow \infty} \frac{\int_\xi^t f(s) \int_\xi^s |w(\tau)|^q \, d\tau \, ds}{\int_\xi^t f(s) \, ds} = \int_\xi^\infty |w(s)|^q \, ds < \infty.$$

By Hölder's inequality

$$0 \leq \lim_{t \rightarrow \infty} \frac{|\int_\xi^t f(s)w(s) \, ds|}{\int_\xi^t f(s) \, ds} \leq \lim_{t \rightarrow \infty} \frac{(\int_\xi^t f^p(s) \, ds)^{1/p} (\int_\xi^t |w(s)|^q \, ds)^{1/q}}{\int_\xi^t f(s) \, ds} = 0.$$

Hence, by (9.15), $\lim_{t \rightarrow \infty} A_f(\xi, t)$ exists and

$$\lim_{t \rightarrow \infty} A_f(\xi, t) = w(\xi) - (p-1) \int_\xi^\infty |w(s)|^q \, ds.$$

This completes the proof. □

As a consequence of the previous statement we have the following oscillation criterion which is the half-linear extension of the criterion of Coles [46], this statement can be also viewed as an extension of Theorem 5.7.

THEOREM 9.2. *The following statements hold:*

- (i) *If there exists $f \in \mathcal{J}$ such that (9.6) holds, then either (9.1) is oscillatory, or $\lim_{t \rightarrow \infty} A_g(\cdot, t)$ exists finite for every $g \in \mathcal{J}_0$.*
- (ii) *If there exist two nonnegative bounded functions f, g on an interval $[T, \infty)$ satisfying $\int^\infty f(t) dt = \infty = \int^\infty g(t) dt$ such that*

$$\lim_{t \rightarrow \infty} A_f(T, t) < \lim_{t \rightarrow \infty} A_g(T, t),$$

then Equation (9.1) is oscillatory.

PROOF. (i) Suppose that (9.1) is nonoscillatory. Then by Theorem 9.1 every solution of the associated Riccati equation (9.2) satisfies $\int^\infty |w(t)|^q dt < \infty$ and hence $\lim_{t \rightarrow \infty} A_g(\cdot, t)$ exists finite for every $g \in \mathcal{J}_0$.

(ii) Let $\alpha, \beta \in \mathbb{R}$ be such that

$$\lim_{t \rightarrow \infty} A_f(T, t) < \alpha < \beta < \lim_{t \rightarrow \infty} A_g(T, t).$$

Let $h(t) = g(t)$ for $T \leq t \leq t_1$, where t_1 is determined such that $A_g(T, t_1) \geq \beta$ and $\int_T^{t_1} g(s) ds \geq 1$. Let $h(t) = f(t)$ for $t_1 \leq t_2$ where t_2 is determined such that $A_h(T, t_2) \leq \alpha$ and $\int_T^{t_1} h(s) ds \geq 2$. This is possible because

$$\begin{aligned} A_h(T, t_2) &= \frac{\int_T^{t_2} h(s) \int_T^s c(\tau) d\tau ds}{\int_T^{t_2} h(s) ds} \\ &= \frac{\int_T^{t_1} [g(s) - f(s)] \int_T^s c(\tau) d\tau ds}{\int_T^{t_1} g(s) ds + \int_{t_1}^{t_2} f(s) ds} \\ &\quad + \frac{\int_T^{t_2} f(s) \int_T^s c(\tau) d\tau ds}{\int_T^{t_2} f(s) ds} \frac{\int_T^{t_2} f(s) ds}{\int_T^{t_1} g(s) ds + \int_{t_1}^{t_2} f(s) ds} \\ &= A_f(T, t_2) [1 + o(1)] + o(1), \end{aligned}$$

as $t_2 \rightarrow \infty$. Continuing in this manner, we obtain a nonnegative and bounded function h defined on $[T, \infty)$ such that

$$\limsup_{t \rightarrow \infty} A_h(T, t) \geq \beta > \alpha \geq \liminf_{t \rightarrow \infty} A_h(T, t).$$

Hence, by the part (i), Equation (9.1) is oscillatory. □

9.3. Generalized Hartman–Wintner’s criterion

In Section 5 we have shown that (0.1) with $\int^\infty r^{1-q}(t) dt = \infty$ is oscillatory provided

$$-\infty < \liminf_{t \rightarrow \infty} \frac{\int_T^t r^{1-q}(s) \int_T^s c(\tau) d\tau ds}{\int_T^t r^{1-q}(s) ds} < \limsup_{t \rightarrow \infty} \frac{\int_T^t r^{1-q}(s) \int_T^s c(\tau) d\tau ds}{\int_T^t r^{1-q}(s) ds}$$

or

$$\lim_{t \rightarrow \infty} \frac{\int_T^t r^{1-q}(s) \int_T^s c(\tau) d\tau ds}{\int_T^t r^{1-q}(s) ds} = \infty.$$

In this subsection we present one extension of this criterion which was established in [51]. In agreement with the remark from the introduction of this section, we formulate this criterion for (9.1). For the sake of convenience, similarly as in the original paper [51], we introduce the linear operator $A : C[0, \infty) \rightarrow C[0, \infty)$ defined by

$$(Af)(t) := \frac{1}{t} \int_0^t f(s) ds, \quad (Af)(0) := 0. \tag{9.16}$$

By A^n we denote the n th iteration of A .

THEOREM 9.3. *Let $C(t) := \int_0^t c(s) ds$. If there exists $n \in \mathbb{N}$ such that*

$$-\infty < \liminf_{t \rightarrow \infty} (A^n C)(t) < \limsup_{t \rightarrow \infty} (A^n C)(t), \tag{9.17}$$

or

$$\lim_{t \rightarrow \infty} (A^n C)(t) = \infty \tag{9.18}$$

then (9.1) is oscillatory.

PROOF. The proof is similar to that of Theorem 5.6 and of Theorem 5.7. Suppose, by contradiction, that (9.1) is nonoscillatory and let w be a solution of the associated Riccati equation (9.2). For convenience, we suppose that this solution is defined on $[0, \infty)$, this is no loss of generality since the lower integration limit 0 in the next computation can be replaced by any T sufficiently large. Integrating Equation (9.2) from 0 to t we get

$$w(t) - w(0) + C(t) + (p - 1) \int_0^t |w(s)|^q ds = 0. \tag{9.19}$$

The application of the operator A^n to the previous equation yields

$$(A^n w)(t) + (A^n C)(t) + (p - 1)A^n \left(\int_0^t |w(s)|^q ds \right) - w(0) = 0. \tag{9.20}$$

Each of the conditions (i), (ii) implies the existence of $K \geq 0$ such that $(A^n C)(t) \geq -K$ for large t . This implies that $\int^\infty |w(t)|^q dt < \infty$. The proof of this claim goes by contradiction in the same way as in the proof of Theorem 5.6. Having proved the convergence of $\int^\infty |w(t)|^q dt$, again in the same way as in the proof of Theorem 5.6 we prove that $\lim_{t \rightarrow \infty} (A^n C)(t)$ exists finite, a contradiction with (i) or (ii). \square

The following example, taken again from [51], presents a construction of the function c for which the classical Hartman–Wintner criterion (i.e., the case $n = 1$ in the previous theorem) does not apply, while the previous theorem with $n = 2$ does.

EXAMPLE 9.1. Let $\{a_n\}_{n=1}^\infty, \{b_n\}_{n=1}^\infty$ be two sequences of real numbers defined by $a_n = n - 2^{-n}, b_n = n + 2^{-n}, n \in \mathbb{N}$. Let $\{g_n\}_{n=1}^\infty$ denote a sequence of functions $g_n : [0, \infty) \rightarrow \mathbb{R}$ of the class C^2 such that $g_n(t) > 0$ if $t \in (a_n, b_n)$ and $g_n(t) = 0$ otherwise. We also ask that

$$\int_0^\infty g_n(t) dt = n. \tag{9.21}$$

Next define $g : [0, \infty) \rightarrow \mathbb{R}$ by

$$g(t) = \sum_{n=1}^\infty (-1)^n g_n(t). \tag{9.22}$$

The function g is also of the class C^2 and using this function we define

$$c(t) = (tg(t))'', \quad C(t) := \int_0^t c(s) ds. \tag{9.23}$$

The reason for defining c in this form is two-fold. On one hand, from (9.23) we find that

$$(AC)(t) = \frac{1}{t} \int_0^t \int_0^s c(\tau) d\tau = g(t), \tag{9.24}$$

and from (9.21) and the mean value theorem

$$\max_{t \in [0, \infty)} g_n(t) \geq n2^{n-1}. \tag{9.25}$$

Thus, from (9.24) and (9.25) we obtain $\liminf_{t \rightarrow \infty} (AC)(t) = -\infty$, so the Hartman–Wintner theorem does not apply. Let us consider $p = 2$ for a moment (so we actually consider the linear equation) in (9.1) and we note that the Lebesgue measure of the set $\{t \mid \int_0^t c(s) ds \neq 0\}$ is finite. This implies that

$$\lim_{t \rightarrow \infty} \text{approx} \int_0^t c(s) ds = 0,$$

so the criterion of Olech, Opial and Wazewski [185] does not apply either. Recall that

$$\lim_{t \rightarrow \infty} \text{approx } f(t) = l$$

if and only if, by definition,

$$l = \sup\{\ell: m\{t: f(t) > \ell\} = \infty\} = \inf\{\ell: m\{t: f(t) < \ell\} = \infty\}.$$

Here $m\{\cdot\}$ denoted the Lebesgue measure of the set indicated. Recall also that the oscillation criterion of [185] states that the equation $x'' + c(t)x = 0$ is oscillatory provided

$$\lim_{t \rightarrow \infty} \text{approx } \int_0^t c(s) \, ds = \infty.$$

Nevertheless, by Theorem 9.3, Equation (9.1) with any $p > 1$ is oscillatory. Indeed, from (9.25) we have $\limsup_{t \rightarrow \infty} (AC)(t) = \infty$. Also, for $t \in (b_n, a_{n+1}) = (n + 2^{-n}, n + 1 - 2^{-(n+1)})$, we have

$$(A^2C)(t) = \begin{cases} \frac{n}{2t}, & n \text{ even,} \\ \frac{-(n+1)}{2t}, & n \text{ odd.} \end{cases}$$

From the last equality can be easily shown that $(A^2C)(t)$ is bounded for $t \in (0, \infty)$. Hence from (9.17) Equation (9.1) is oscillatory.

9.4. Generalized Kamenev criterion

The classical Kamenev criterion concerns the linear equation $x'' + c(t)x = 0$ and claims that this equation is oscillatory provided there exists $\lambda > 1$ such that

$$\limsup_{t \rightarrow \infty} \frac{1}{t^\lambda} \int_0^t (t-s)^\lambda c(s) \, ds = \infty. \tag{9.26}$$

The following half-linear extension concerns general half-linear equation (0.1) and it is taken from [150].

THEOREM 9.4. *Suppose that there exists $\lambda > p - 1$ such that*

$$\limsup_{t \rightarrow \infty} \frac{1}{t^\lambda} \int_0^t (t-s)^{\lambda-p} \left[(t-s)^p c(s) - \left(\frac{\lambda}{p}\right)^p r(s) \right] ds = \infty. \tag{9.27}$$

Then (0.1) is oscillatory.

PROOF. Suppose that (0.1) is nonoscillatory, i.e., there exists a solution of the associated Riccati equation (2.1). Multiplying this equation by $(t - s)^\lambda$ and integrating it from T to t , T sufficiently large, we get

$$\begin{aligned}
 & -(t - T)^\lambda w(T) + \lambda \int_T^t (t - s)^{\lambda-1} w(s) \, ds \\
 & + (p - 1) \int_T^t (t - s)^\lambda r^{1-q}(s) |w(s)|^q \, ds + \int_T^t (t - s)^\lambda c(s) \, ds = 0. \tag{9.28}
 \end{aligned}$$

Using the Young inequality (2.6) with

$$u = \frac{\lambda}{p} (t - s)^{\frac{\lambda-p}{p}} r^{\frac{1}{p}}, \quad v = (t - s)^{\frac{\lambda}{q}} r^{\frac{1-q}{q}} |w(s)|,$$

we obtain

$$\begin{aligned}
 (t - s)^\lambda r^{1-q}(s) |w(s)|^q & \geq (q - 1) \lambda (t - s)^{\lambda-1} |w(s)| \\
 & - (q - 1) \left(\frac{\lambda}{p}\right)^p (t - s)^{\lambda-p} r(s)
 \end{aligned}$$

for $T \leq s \leq t$. This inequality and (9.28) imply

$$\int_T^t (t - s)^{\lambda-p} \left[(t - s)^p c(s) - \left(\frac{\lambda}{p}\right)^p r(s) \right] \, ds \leq (t - T)^\lambda w(T).$$

Thus

$$\limsup_{t \rightarrow \infty} \frac{1}{t^\lambda} \int_T^t (t - s)^{\lambda-p} \left[(t - s)^p c(s) - \left(\frac{\lambda}{p}\right)^p r(s) \right] \, ds \leq w(T).$$

which contradicts to (9.27). □

REMARK 9.1. Clearly, if $r(t) \equiv 1$, then $\lim_{t \rightarrow \infty} \frac{1}{t^\lambda} \int_T^t (t - s)^{\lambda-p} \left(\frac{\lambda}{p}\right)^p r(s) \, ds = 0$ and hence Equation (9.1) is oscillatory if

$$\limsup_{t \rightarrow \infty} \frac{1}{t^\lambda} \int_0^t (t - s)^{\lambda-p} c(s) \, ds = \infty \quad \text{for some } \lambda > p - 1.$$

which is the half-linear extension of the classical Kamenev linear oscillation criterion.

9.5. Another refinement of the Hartman–Wintner theorem

The results formulated here are taken from [122], where the equation

$$x'' + c(t)|x|^{p-1}|x'|^{2-p} \operatorname{sgn} x = 0 \tag{9.29}$$

with $p \in (1, 2]$ is considered. Related results on Equation (9.29) can be found also in [42, 162]. Equation of the form (9.29) can be obtained from (9.1) using the identity

$$(\Phi(x'))' = (p - 1)x''|x'|^{p-2},$$

so the results of this subsection apply also to (9.1) as noted in [122, Sec. 2]. We prefer here the original formulation to illustrate the variety of approaches to half-linear oscillation theory.

Denote

$$c_p(t) = \frac{(p - 1)^2}{t^{p-1}} \int_1^t s^{p-2} \int_1^s c(\tau) \, d\tau \, ds.$$

Using essentially the same idea as in the proofs of Theorems 5.6 and 5.7 the following statement is proved.

THEOREM 9.5. *Let either $\lim_{t \rightarrow \infty} c_p(t) = \infty$ or*

$$-\infty < \liminf_{t \rightarrow \infty} c_p(t) < \limsup_{t \rightarrow \infty} c_p(t).$$

Then Equation (9.29) is oscillatory.

Consequently, in the next investigation we suppose

$$\lim_{t \rightarrow \infty} c_p(t) =: c_p(\infty) \tag{9.30}$$

exists finite. The following theorem shows that (9.1) is oscillatory if $c_p(t)$ does not tend to its limit too rapidly.

THEOREM 9.6. *Suppose that (9.30) holds and*

$$\limsup_{t \rightarrow \infty} \frac{t^{p-1}}{\lg t} (c_p(\infty) - c_p(t)) > \left(\frac{p - 1}{p}\right)^p. \tag{9.31}$$

Then Equation (9.29) is oscillatory.

PROOF. Suppose, by contradiction, that (9.29) is nonoscillatory and $w = \Phi(x'/x)$ is a solution of the associated Riccati equation

$$w' + (p - 1)c(t) + (p - 1)|w|^q = 0.$$

Integrating this equation from t to ∞ we have a variant of the Riccati integral equation

$$w(t) = c_p(\infty) - (p - 1) \int_1^t c(s) \, ds + (p - 1) \int_t^\infty |w(s)|^q \, ds.$$

Multiplying both sides of this equation by t^{p-2} and integrating from T to t , T sufficiently large, we obtain (integrating one of the terms by parts)

$$\begin{aligned} & \int_T^t s^{p-2} \left[c_p(\infty) - (p-1) \int_1^s c(\tau) d\tau \right] ds \\ &= \int_T^t \frac{s^{p-1} w(s) - s^{p-1} |w(s)|^q}{s} ds - t^{p-1} \int_t^\infty |w(s)|^q ds \\ & \quad + T^{p-1} \int_T^\infty |w(s)|^q ds. \end{aligned} \tag{9.32}$$

Since we have the inequality $|\lambda|^q - \lambda + \frac{1}{p} \left(\frac{p-1}{p}\right)^{p-1} \geq 0$ for every $\lambda \in \mathbb{R}$, (9.32) implies

$$\begin{aligned} t^{p-1} (c_p(\infty) - c_p(t)) &\leq \left(\frac{p-1}{p}\right)^p \lg \frac{t}{T} + T^{p-1} c_p(\infty) \\ & \quad + (p-1) T^{p-1} \int_T^\infty |w(s)|^s ds - T^{p-1} c_p(T). \end{aligned}$$

Therefore

$$\limsup_{t \rightarrow \infty} \frac{t^{p-1}}{\lg t} (c_p(\infty) - c_p(t)) \leq \left(\frac{p-1}{p}\right)^p,$$

which contradicts (9.31). □

REMARK 9.2. Here we have presented only one of several (non)oscillation criteria proved in [122]. These criteria are formulated in term of the limit behavior (as $t \rightarrow \infty$) of the functions

$$\begin{aligned} Q_p(t) &:= t^{p-1} \left(c_p(\infty) - (p-1) \int_1^t c(s) ds \right), \\ H_p(t) &:= \frac{p-1}{t} \int_1^t s^p c(s) ds. \end{aligned}$$

We refer to the above mentioned paper [122] for details.

9.6. Half-linear Willet's criteria

Results of this subsection extend the linear oscillation and nonoscillation criteria of Willet [217] and are presented in [153].

LEMMA 9.1. *Suppose that $B(s)$ and $Q(t, s)$ are nonnegative continuous functions on $[T, \infty)$ and $[T, \infty) \times [T, \infty)$, respectively.*

(i) If

$$\int_t^\infty Q(t, s)B^q(s) \, ds \leq p^{-q}B(t), \quad t \geq T, \quad (9.33)$$

then the equation

$$v(t) = B(t) + (p-1) \int_t^\infty Q(t, s)|v(s)|^q \, ds, \quad (9.34)$$

has a solution on $[T, \infty)$.

(ii) If there exists $\varepsilon > 0$ such that

$$\int_t^\infty Q(s, t)B^q(s) \, ds \geq p^{-q}(1 + \varepsilon)B(t) \neq 0, \quad t \geq T, \quad (9.35)$$

then the inequality

$$v(t) \geq B(t) + (p-1) \int_t^\infty Q(t, s)|v(s)|^q \, ds, \quad (9.36)$$

possesses no solution on $[T, \infty)$.

PROOF. (i) Let $v_1(t) = B(t)$ and define

$$v_{k+1}(t) = B(t) + (p-1) \int_t^\infty Q(t, s)|v_k(s)|^q \, ds, \quad k \in \mathbb{N}.$$

Then by (9.33)

$$\begin{aligned} v_2(t) &= B(t) + (p-1) \int_t^\infty Q(t, s)B^q(s) \, ds \\ &\leq B(t) + (p-1)p^{-q}B(t) \leq pB(t), \end{aligned}$$

and $v_1(t) \leq v_2(t)$. Suppose, by induction, that $v_1(t) \leq v_2(t) \leq \dots \leq v_n(t) \leq pB(t)$. Then

$$\begin{aligned} v_{n+1}(t) &\leq B(t) + (p-1) \int_t^\infty Q(t, s)|v_n(s)|^q \, ds \\ &\leq B(t) + (p-1)p^q \int_t^\infty Q(t, s)B^q(s) \, ds \\ &\leq B(t) + (p-1)p^q \cdot p^{-q}B(t) = pB(t). \end{aligned}$$

Thus, the sequence $\{v_n\}$ is nondecreasing and bounded above. Hence, it converges uniformly to a continuous function v which is a solution of (9.34).

(ii) Suppose, to the contrary, that v is a continuous function satisfying (9.36). Then $v(t) \geq B(t) \geq 0$ which implies $v^q(t) \geq B^q(t) \geq 0$. Thus

$$v(t) \geq B(t) + (p - 1) \int_t^\infty Q(t, s) B^q(s) ds \geq [1 + (p - 1)(1 + \varepsilon)p^{-q}]B(t).$$

Continuing in this way, we obtain $v(t) \geq a_n B(t)$, where $a_1 = 1, a_n < a_{n+1}$ and

$$a_{n+1} = 1 + (p - 1)a_n^q p^{-q}(1 + \varepsilon). \tag{9.37}$$

We claim that $\lim_{n \rightarrow \infty} a_n = \infty$. Assume, to the contrary, that $\lim_{n \rightarrow \infty} a_n = a < \infty$. Then $a \geq 1$ and from (9.37)

$$a = 1 + (p - 1)(1 + \varepsilon)a^q p^{-q},$$

but this is the contradiction since the equation $\lambda = 1 + (p - 1)(1 + \varepsilon)\lambda^q p^{-q}$ has no solution for which $\lambda \geq 0$. This contradiction proves that $\lim_{n \rightarrow \infty} a_n = \infty$ and hence $B(t) \equiv 0$. This contradiction with (9.35) proves the lemma. □

As a direct consequence of the previous lemma we have the following oscillation and nonoscillation criteria.

THEOREM 9.7. *Suppose that $\int^\infty c(t) dt$ is convergent and $C(t) := \int_t^\infty c(s) ds \geq 0$ for large t .*

- (i) *If $\int_t^\infty C^q(s) ds \leq p^{-q} C(t)$ for large t , then (9.1) is nonoscillatory.*
- (ii) *If $C(t) \not\equiv 0$ for large t and there exists $\varepsilon > 0$ such that*

$$\int_t^\infty C^q(s) ds \geq p^{-q}(1 + \varepsilon)C(t)$$

for large t , then (9.1) is oscillatory.

PROOF. (i) By the part (i) of the previous lemma there exists a solution of the integral equation (5.21), hence (9.1) is nonoscillatory by Theorem 5.8.

(ii) By contradiction, suppose that (9.1) is nonoscillatory. Then (5.21) has a solution for large t , but it contradicts the part (ii) of the previous lemma. □

REMARK 9.3. The constant p^{-q} in the previous statement is the best possible as shows the Euler equation (4.20) with the critical constant $\gamma = \tilde{\gamma} = (\frac{p-1}{p})^p$.

9.7. Equations with periodic coefficient

The oscillation criterion presented in this subsection can be found in the paper [65].

THEOREM 9.8. *Suppose that the function $c(t)$ in (9.1) is a periodic function with the period ω , $c(t) \not\equiv 0$, and*

$$\int_0^\omega c(t) dt \geq 0,$$

then (9.1) is oscillatory both at $t = \infty$ and at $t = -\infty$.

PROOF. To prove oscillation of (9.1), it is sufficient to find a solution of this equation with at least two zeros. Indeed, the periodicity of the function c implies that if x is a solution of (9.1) then $x(t \pm \omega)$ is a solution as well and hence any solution with two zeros has actually infinitely many of them, tending both to ∞ and $-\infty$.

The statement of theorem is clearly true if c is a positive constant function (since then $x(t) = \sin_p \mu t$ is a solution of this equation, where μ is a constant depending on c and p). So we need to consider the cases when $c(t)$ is not a constant only. Also, it is sufficient to deal with the case when $\int_0^\omega c(t) dt = 0$ because otherwise we can define $c_0 = \frac{1}{\omega} \int_0^\omega c(t) dt > 0$ and $\tilde{c}(t) = c(t) - c_0$. Clearly, we have $c(t) > \tilde{c}(t)$. If we prove (9.1) with \tilde{c} instead of c to be oscillatory then by the Sturmian comparison theorem equation (9.1) is also oscillatory.

Now let

$$C(t) = \int_0^t c(s) ds.$$

This is a continuous periodic function with the period ω . Let γ and δ be defined by

$$C(\delta) = \max_{0 \leq t \leq \omega} C(t), \quad C(\gamma) = \min_{\delta \leq t \leq \delta + \omega} C(t).$$

Then $0 \leq \delta < \gamma < \delta + \omega$ and

$$\int_\gamma^t c(s) ds \geq 0, \quad \int_t^\delta c(s) ds \geq 0 \quad \text{for } t \in \mathbb{R}.$$

Now, by Theorem 8.5 and the remark given below this theorem, the solution of (9.1) given by the initial condition $x(\delta) = 1, x'(\delta) = 0$ has a zero in $(-\infty, \delta)$. Indeed, $C(t) \not\equiv 0$ and

$$\int_t^\delta |s - \delta|^\alpha \left(\int_t^\delta c(\tau) d\tau \right) ds \geq 0 \quad \text{for } t \geq \delta,$$

with any $\alpha \in (-\frac{1}{p}, p - 2]$. Now we need to show that this solution has a zero on (δ, ∞) as well. We proceed by contradiction, suppose that $x(t) > 0$ for $t \geq \delta$. Consider the function $w = -\frac{\Phi(x')}{\Phi(x)}$ on $[\delta, \infty)$. This function satisfies the Riccati differential equation

$$w' = c(t) + (p - 1)|w|^q \tag{9.38}$$

and by integration we have

$$w(t + \omega) - w(t) = (p - 1) \int_t^{t+\omega} |w(s)|^q ds, \tag{9.39}$$

hence $w(t + \omega) > w(t)$. Consider now the sequence $w(\gamma), w(\gamma + \omega), w(\gamma + 2\omega), \dots$. By Theorem 8.5 and by our indirect assumption on the solution $x(t)$, this sequence consists of negative terms:

$$w(\gamma) < w(\gamma + \omega) < w(\gamma + 2\omega) < \dots < 0.$$

Indeed, if $w(\gamma + k\omega) \geq 0$ for some $k \in \mathbb{N}$, then by Theorem 8.5 the solution $x(t)$ would have a zero in $(\gamma + k\omega, \infty)$. Hence $\lim_{k \rightarrow \infty} w(\gamma + k\omega) \leq 0$, consequently by (9.39)

$$w(\gamma) + (p - 1) \int_\gamma^\infty |w(s)|^q ds \leq 0,$$

i.e., the integral $\int_\gamma^\infty |w(s)|^q ds$ is convergent. This implies by (9.38) that

$$w(t) = w(\gamma) + \int_\gamma^t c(s) ds + (p - 1) \int_\gamma^t |w(s)|^q ds$$

and the function $w(t)$ is bounded. Again by (9.38) we find that w' is also bounded, say, $|w'(t)| < L$. Then

$$\begin{aligned} \left| \frac{|w(t_2)|^{q+1} - |w(t_1)|^{q+1}}{q + 1} \right| &= \left| \int_{t_1}^{t_2} w'(s) |w(s)|^q \operatorname{sgn} w(s) ds \right| \\ &\leq L \int_{t_1}^{t_2} |w(s)|^q ds, \end{aligned}$$

$\gamma < t_1 < t_2$, hence $\lim_{t \rightarrow \infty} |w(t)|^{q+1}$ exists. Clearly, we have $\lim_{t \rightarrow \infty} w(t) = 0$.

On the other hand, $w(\delta) = 0$, and by (9.39) we have $\lim_{k \rightarrow \infty} w(\delta + k\omega) > 0$ and this contradicts the fact that $\lim_{t \rightarrow \infty} w(t) = 0$. □

9.8. Equations with almost periodic coefficient

Now suppose that $c : \mathbb{R} \rightarrow \mathbb{R}$ is a Besicovitch almost periodic function. Recall that this class of functions is defined as the closure of the set of finite trigonometric polynomials with the Besicovitch seminorm

$$\|c\|_B = \limsup_{t \rightarrow \infty} \frac{1}{2t} \int_{-t}^t |c(s)| ds.$$

The mean value $M\{c\}$ of a function c is defined by

$$M\{c\} = \lim_{t \rightarrow \infty} \frac{1}{t} \int_{t_0}^t c(s) \, ds,$$

for some $t_0 \geq 0$, see, e.g., [19,31] for details.

The proof of the main result of this subsection is based on the following Hartman–Wintner-type lemma. We present it without proof which is similar, in a certain sense, to the proof of Theorem 5.6. For details we refer to [151].

LEMMA 9.2. *Suppose that $c : [t_0, \infty) \rightarrow \mathbb{R}$ is a locally integrable function with $M\{c\} = 0$ and (9.1) is nonoscillatory. Then*

$$\lim_{t \rightarrow \infty} \frac{1}{t} \int_{t_0}^t |w(s)|^q \, ds = 0$$

for every solution w of the associated Riccati equation (9.2).

THEOREM 9.9. *Suppose that c is a Besicovitch almost periodic function with the mean value $M\{c\} = 0$ and $M\{|c|\} > 0$. Then*

$$(\Phi(x'))' + \lambda c(t)\Phi(x) = 0 \tag{9.40}$$

is oscillatory for every $\lambda \neq 0$.

PROOF. Suppose that (9.40) is nonoscillatory for some λ and $w = -\frac{\Phi(x')}{\Phi(x)}$ be the corresponding solution of the associated Riccati equation

$$w' = \lambda c(t) + (p - 1)|w(t)|^q. \tag{9.41}$$

We have used the Riccati substitution with the ‘ $-$ ’ sign to keep consistency with the original paper [151] and also to show that this minus sign in the Riccati substitution makes sometimes computations slightly easier (compare also the previous subsection).

Integrating (9.41) (with $\delta > 0$ and t sufficiently large) we get

$$\frac{\lambda}{\delta} \int_t^{t+\delta} c(s) \, ds = \frac{w(t + \delta)}{\delta} - \frac{w(t)}{\delta} - \frac{p - 1}{\delta} \int_t^{t+\delta} |w(s)|^q \, ds. \tag{9.42}$$

Applying the Besicovitch seminorm $\|\cdot\|_{B'}$ defined by

$$\|f\|_{B'} = \limsup_{t \rightarrow \infty} \frac{1}{t} \int_{t_0}^t |f(s)| \, ds$$

to (9.42), we find

$$\begin{aligned} 0 &\leq \left\| \frac{\lambda}{\delta} \int_t^{t+\delta} c(s) \, ds \right\|_{B'} \\ &\leq \left\| \frac{p-1}{\delta} \int_t^{t+\delta} |w(s)|^q \, ds \right\|_{B'} + \left\| \frac{w(t+\delta)}{\delta} \right\|_{B'} + \left\| \frac{w(t)}{\delta} \right\|_{B'} \end{aligned}$$

for all $\delta > 0$. From Lemma 9.2 follows that $M\{|w|^q\} = 0$, thus $\|w\|_{B'} = \|w(t+\delta)\|_{B'} = 0$ for all $\delta > 0$. Using the Fubini theorem we have for some $t_0 > 0$

$$\begin{aligned} \frac{1}{\delta t} \int_{t_0}^t \int_s^{s+\delta} |w(\tau)|^q \, d\tau \, ds &= \frac{1}{\delta t} \int_{t_0}^t \int_0^\delta |w(\tau+s)|^q \, d\tau \, ds \\ &= \frac{1}{\delta t} \int_0^\delta \int_{t_0}^t |w(\tau+s)|^q \, ds \, d\tau \\ &\leq \frac{1}{\delta t} \int_0^\delta \int_{t_0}^{t+\delta} |w(s)|^q \, ds \, d\tau \\ &= \frac{1}{t} \int_{t_0}^{t+\delta} |w(s)|^q \, ds \end{aligned}$$

for any fixed $\delta > 0$. Using the last computation and Lemma 9.2 we have

$$\left\| \frac{p-1}{\delta} \int_t^{t+\delta} |w(s)|^q \, ds \right\|_{B'} = 0.$$

Applying the last equality, coupled with the fact that $\|w(t)\|_{B'} = 0$ to the previous computation, we see that

$$\left\| \frac{\lambda}{\delta} \int_t^{t+\delta} c(s) \, ds \right\|_{B'} = 0 \tag{9.43}$$

(for every $\delta > 0$). Since c is almost periodic, it follows from [19, p. 97]

$$\lim_{\delta \rightarrow 0^+} \left\| c(t) - \frac{1}{\delta} \int_t^{t+\delta} c(s) \, ds \right\|_{B'} = 0.$$

This and (9.43) imply $M\{|c|\} = \|c\|_{B'} = 0$ which is a contradiction. \square

9.9. Generalized H -function averaging technique

Oscillation criteria of this subsection are established in [152]. Our presentation takes into account the remark of Rogovchenko [204] which shows that one of the assumptions given

in the original paper [152] is redundant. In the linear case, the method used in this subsection was introduced by Philos [189].

THEOREM 9.10. *Let $D_0 = \{(t, s) : t > s \geq t_0\}$ and $D = \{(t, s) : t \geq s \geq t_0\}$. Assume that the function $H \in C(D; \mathbb{R})$ satisfies the following conditions:*

- (i) $H(t, t) = 0$ for $t \geq t_0$ and $H(t, s) > 0$ for $t > s \geq t_0$;
- (ii) H has a continuous nonpositive partial derivative on D_0 with respect to the second variable.

Suppose that $h : D_0 \rightarrow \mathbb{R}$ is a continuous function such that

$$-\frac{\partial H}{\partial s}(t, s) = h(t, s)[H(t, s)]^{1/q} \quad \text{for all } (t, s) \in D_0, \quad q = \frac{p}{p-1}.$$

If

$$\limsup_{t \rightarrow \infty} \frac{1}{H(t, t_0)} \int_{t_0}^t \left[H(t, s)c(s) - \left(\frac{1}{p}h(t, s) \right)^p \right] ds = \infty \tag{9.44}$$

then (9.1) is oscillatory.

PROOF. Suppose that (9.1) is nonoscillatory and v is a solution of the associated Riccati equation (9.2) which exists on the interval $[T_0, \infty)$, $T_0 \geq t_0$. We have for $t \geq T \geq T_0$

$$\begin{aligned} & \int_T^t H(t, s)c(s) \, ds \\ &= H(t, T)v(T) - \int_T^t \left(-\frac{\partial H}{\partial s}(t, s) \right) v(s) \, ds - (p-1) \int_T^t H(t, s)|v(s)|^q \, ds \\ &= H(t, T)v(T) - \int_T^t \left\{ h(t, s)[H(t, s)]^{1/q}v(s) + (p-1)H(t, s)|v(s)|^q \right\} \, ds \\ &= H(t, T)v(T) - \int_T^t \left\{ h(t, s)[H(t, s)]^{1/q}v(s) + (p-1)H(t, s)|v(s)|^q \right. \\ & \quad \left. + \left(\frac{1}{p}h(t, s) \right)^p \right\} \, ds + \int_T^t \left(\frac{1}{p}h(t, s) \right)^p \, ds. \end{aligned}$$

Hence, for $t \geq T \geq T_0$, we have

$$\begin{aligned} & \int_T^t \left\{ H(t, s)c(s) - \left(\frac{1}{p}h(t, s) \right)^p \right\} \, ds \\ &= H(t, T)v(T) - \int_T^t \left\{ h(t, s)[H(t, s)]^{1/q}v(s) + (p-1)H(t, s)|v(s)|^q \right. \\ & \quad \left. + \left(\frac{1}{p}h(t, s) \right)^p \right\} \, ds. \end{aligned}$$

Since $q > 1$, by Young's inequality (2.6)

$$h(t, s)[H(t, s)]^{1/q}v(s) + (p-1)H(t, s)|v(s)|^q + \left(\frac{1}{p}h(t, s)\right)^p \geq 0$$

for $t \geq s \geq T_0$. This implies that for every $t \geq T_0$

$$\begin{aligned} & \int_{T_0}^t \left\{ H(t, s)c(s) - \left(\frac{1}{p}h(t, s)\right)^p \right\} ds \\ & \leq H(t, T_0)v(T_0) \leq H(t, T_0)|v(T_0)| \leq H(t, t_0)|v(T_0)|. \end{aligned}$$

Therefore,

$$\begin{aligned} & \int_{t_0}^t \left\{ H(t, s)c(s) - \left(\frac{1}{p}h(t, s)\right)^p \right\} ds \\ & = \int_{t_0}^{T_0} \left\{ H(t, s)c(s) - \left(\frac{1}{p}h(t, s)\right)^p \right\} ds \\ & \quad + \int_{T_0}^t \left\{ H(t, s)c(s) - \left(\frac{1}{p}h(t, s)\right)^p \right\} ds \\ & \leq H(t, t_0) \int_{t_0}^{T_0} |c(s)| ds + H(t, t_0)|v(T_0)| \\ & = H(t, t_0) \left\{ \int_{t_0}^{T_0} |c(s)| ds + |v(T_0)| \right\}. \end{aligned}$$

This gives

$$\begin{aligned} & \limsup_{t \rightarrow \infty} \frac{1}{H(t, t_0)} \int_{t_0}^t \left\{ H(t, s)c(s) - \left(\frac{1}{p}h(t, s)\right)^p \right\} ds \\ & \leq \int_{t_0}^{T_0} |c(s)| ds + |v(T_0)|. \end{aligned}$$

This contradiction with (9.44) completes the proof. \square

The next statement is also taken from [152]. We present it without proof. This proof, similar to the proof of the previous theorem, follows more or less the original idea of Philos [189]. For comparison with the linear case we also refer to the papers of Yan [220, 221]. Taking $H(t, s) = (t-s)^\lambda$, $\lambda > 0$, the previous statement reduces to the half-linear version of Kamenev's oscillation criterion presented in Section 9.4.

THEOREM 9.11. *Let H and h be as in the previous theorem, and let*

$$\inf_{s \geq t_0} \left\{ \liminf_{t \rightarrow \infty} \frac{H(t, s)}{H(t, t_0)} \right\} > 0. \tag{9.45}$$

Suppose that

$$\limsup_{t \rightarrow \infty} \frac{1}{H(t, t_0)} \int_{t_0}^t h(t, s) \, ds < \infty$$

and there exists a function $A \in C[t_0, \infty)$ such that

$$\int^{\infty} A_+^q(s) \, ds = \infty, \tag{9.46}$$

where $A_+(t) = \max\{A(t), 0\}$. If

$$\limsup_{t \rightarrow \infty} \frac{1}{H(t, T)} \int_T^t \left\{ H(t, s)c(s) - \left(\frac{1}{p}h(t, s) \right)^p \right\} \, ds \geq A(T)$$

for $T \geq t_0$ then Equation (9.1) is oscillatory.

10. Various oscillation problems

In this section we collect various problems of half-linear oscillation theory. We start with an asymptotic formula for the distance between consecutive zeros of oscillatory solutions of half-linear equations. Then we turn our attention to various problems like oscillation of forced and retarded equations and to similar problems.

10.1. Asymptotic formula for distance of zeros of oscillatory solutions

The results of this subsection are taken from [93] and present the asymptotic formula for the distance of consecutive zeros of oscillatory solutions of the equation

$$(\Phi(x'))' + (p - 1)c(t)\Phi(x) = 0. \tag{10.1}$$

It is supposed that $c(t) > 0$ for large t and the results are based on the generalized Prüfer transformation from Section 2. In this transformation, a nontrivial solution and its derivative are expressed via the generalized half-linear sine and cosine functions. Recall that the half-linear sine function, denoted by $S = S(t)$ or $\sin_p t$, is the solution of the equation

$$(\Phi(x'))' + (p - 1)\Phi(x) = 0$$

satisfying the initial condition $x(0) = 0$, $x'(0) = 1$ and the half-linear cosine function is defined by $\cos_p t = S'(t)$.

THEOREM 10.1. Suppose that c is a differentiable function such that $c(t) > 0$ on an interval $[T, \infty)$, and

$$\lim_{t \rightarrow \infty} c'(t)[c(t)]^{-\frac{p+1}{p}} = 0 \quad (10.2)$$

holds. Then (10.1) is oscillatory. Moreover, if $N[x; T]$ denotes the number of zeros of a solution x of (10.1) in the interval $[a, T]$, then

$$N[x; T] = P[x; T] + R[x; T], \quad (10.3)$$

where $P[x; T]$ is the principal term given by

$$P[x; T] = \frac{1}{\pi_p} \int_a^T [c(s)]^{\frac{1}{p}} ds$$

and $R[x; T]$ is the remainder which is of smaller order than $P[x; T]$ as $T \rightarrow \infty$ and satisfies

$$|R[x; T]| \leq \frac{1}{p\pi_p} \int_a^T \frac{|c'(s)|}{c(s)} ds + O(1).$$

PROOF. Set $C(t) := c'(t)[c(t)]^{-\frac{p+1}{p}}$ and define

$$C^*(t) = \sup\{|C(s)|: s \geq t\}, \quad t \geq a. \quad (10.4)$$

Then $C^*(t)$ is nonincreasing and satisfies $\lim_{t \rightarrow \infty} C^*(t) = 0$ by (10.2). We have

$$|[c(t+h)]^{-\frac{1}{p}} - [c(t)]^{-\frac{1}{p}}| = \frac{1}{p} \left| \int_t^{t+h} C(s) ds \right| \leq \frac{|h|}{p} C^*(t),$$

which implies that

$$\limsup_{h \rightarrow \infty} \frac{[c(t+h)]^{-\frac{1}{p}}}{t+h} \leq \frac{C^*(t)}{p}.$$

It follows that $\lim_{t \rightarrow \infty} t^{-1}[c(t)]^{-\frac{1}{p}} = 0$, or equivalently, $\lim_{t \rightarrow \infty} t^p c(t) = \infty$. This implies, by Theorem 4.5, that (10.1) is oscillatory.

Now we turn our attention to the proof of the asymptotic formulas for numbers of zeros. By the Sturmian comparison theorem (Theorem 2.4) we have that $N[x_1; T]$ and $N[x_2; T]$ differ at most by one for any solutions x_1 and x_2 of (10.1), so we may restrict our attention to the solution x_0 of (10.1) determined by the initial conditions $x_0(a) = 0$, $x'_0(a) = 1$. This solution is oscillatory by the first part of the our theorem.

We introduce the polar coordinates $\rho(t)$, $\varphi(t)$ for $x_0(t)$ by setting

$$[c(t)]^{\frac{1}{p}} x_0(t) = \rho(t) S(\varphi(t)), \quad x_0'(t) = \rho(t) S'(\varphi(t)). \quad (10.5)$$

It can be shown without difficulty that $\rho(t)$ and $\varphi(t)$ are continuously differentiable on $[a, \infty)$ and satisfy the differential equations

$$\begin{aligned} \frac{\rho'}{\rho} &= \frac{1}{p} \frac{c'(t)}{c(t)} |S(\varphi)|^p, \\ \varphi' &= [c(t)]^{\frac{1}{p}} + \frac{1}{p} \frac{c'(t)}{c(t)} S(\varphi) \Phi(S'(\varphi)). \end{aligned} \quad (10.6)$$

We use the notation

$$g(\varphi) = S(\varphi) \Phi(S'(\varphi)),$$

in terms of which (10.6) is written as

$$\varphi' = [c(t)]^{\frac{1}{p}} + \frac{1}{p} \frac{c'(t)}{c(t)} g(\varphi). \quad (10.7)$$

From the first equation in (10.5) we see that $x_0(t) = 0$ if and only if $\varphi(t) = j\pi_p$, $j \in \mathbb{Z}$. We may suppose that $\varphi(a) = 0$. In view of (10.2) there is no loss of generality in assuming that

$$C^*(t) < p \quad \text{for } t \geq a,$$

where $C^*(t)$ is defined by (10.4). Since

$$|g(\varphi)| \leq 1 \quad \text{for all } \varphi, \quad (10.8)$$

we have

$$[c(t)]^{\frac{1}{p}} + \frac{1}{p} \frac{c'(t)}{c(t)} g(\varphi(t)) \geq [c(t)]^{\frac{1}{p}} \left(1 - \frac{1}{p} C^*(t)\right) > 0,$$

which implies that $\varphi'(t) > 0$, so that $\varphi(t)$ is increasing for $t \geq a$.

We now integrate (10.7) over $[a, T]$, obtaining

$$\varphi(T) = \int_a^T [c(s)]^{\frac{1}{p}} ds + \frac{1}{p} \int_a^T \frac{c'(s)}{c(s)} g(\varphi(s)) ds = F(T) + G(T), \quad (10.9)$$

where

$$F(T) := \int_a^T [c(s)]^{\frac{1}{p}} ds, \quad G(T) := \frac{1}{p} \int_a^T \frac{c'(s)}{c(s)} g(\varphi(s)) ds.$$

From (10.8) it is clear that

$$|G(T)| \leq \frac{1}{p} \int_a^T \frac{|c'(s)|}{c(s)} ds. \quad (10.10)$$

Noting that the number of zeros of $x_0(t)$ in $[a, T]$ is given by

$$N[x_0; T] = \left[\frac{\varphi(T)}{\pi_p} \right] + 1,$$

where $[u]$ denotes the greatest integer not exceeding u , we see from (10.9) and (10.10) that the conclusion of the theorem holds with the choice

$$P[x_0; T] = \frac{1}{\pi_p} F(T) = \frac{1}{\pi_p} \int_a^T [c(s)]^{\frac{1}{p}} ds.$$

That the term $R[x_0; T] = N[x_0; T] - P[x_0; T]$ is of smaller order than $P[x_0; T]$ follows from the observation that

$$\begin{aligned} \int_a^T \frac{|c'(s)|}{c(s)} ds &= \int_a^T |C(s)| [c(s)]^{\frac{1}{p}} ds \\ &\leq \int_a^T C^*(s) [c(s)]^{\frac{1}{p}} ds = o\left(\int_a^T [c(s)]^{\frac{1}{p}} ds\right) \quad \text{as } T \rightarrow \infty. \end{aligned}$$

This completes the proof. □

EXAMPLE 10.1. Consider the equation

$$(\Phi(x'))' + (p-1)t^\beta \Phi(x) = 0, \quad t \geq 1, \quad (10.11)$$

where β is a constant with $p + \beta > 0$. The function $c(t) = t^\beta$ satisfies

$$\begin{aligned} \int_1^T [c(s)]^{\frac{1}{p}} ds &= \frac{p}{p+\beta} (T^{\frac{p+\beta}{p}} - 1), \\ \int_1^T \frac{|c'(s)|}{c(s)} ds &= |\beta| \log T, \end{aligned}$$

and so we conclude from Theorem 10.1 that the quantity $P[x; T]$ can be taken to be

$$P[x; T] = \frac{p}{(p+\beta)\pi_p} T^{\frac{p+\beta}{p}}$$

and (10.3) holds with this $P[x; T]$ and $R[x; T]$ satisfying

$$R[x; T] = \frac{|\beta|}{p\pi_p} \log T + O(1).$$

REMARK 10.1. (i) The results of this subsection cannot be applied to the generalized Euler equation (4.20), since the function $c(t) = \lambda(p - 1)t^{-p}$ does not satisfy (10.2). A calculation of $P[x; T]$ and $R[x; T]$ for the generalized Euler equation

$$(\Phi(x'))' + \lambda(p - 1)t^{-p}\Phi(x) = 0$$

shows that both of them are of the same logarithmic order as $T \rightarrow \infty$.

(ii) In [191], Piros has investigated a similar problem under a more stringent restriction on $c(t)$, namely he supposed that $c^\nu(t)$ is a concave function of t for some $\nu > 0$. Then he proved that the error term $R[x; T]$ in (10.3) is $O(1)$. Exactly, the differential equation (10.11) with $\beta = \frac{1}{\nu}$ plays the exceptional role in determining the precise value of $R[x; T]$.

10.2. Half-linear Milloux and Armellini–Tonelli–Sansone theorems

Results of this subsection are taken from [15] and [23]. Recall that the classical Armellini–Tonelli–Sansone theorem concerns the convergence to zero of all solutions of the second order linear differential equation

$$x'' + c(t)x = 0. \tag{10.12}$$

In particular, by the theorem of Milloux [175], if the function c is continuously differentiable, nondecreasing, and

$$\lim_{t \rightarrow \infty} c(t) = \infty \tag{10.13}$$

then (10.12) has at least one solution satisfying

$$\lim_{t \rightarrow \infty} x(t) = 0. \tag{10.14}$$

The theorem of Armellini–Tonelli–Sansone deals with the situation when *all* solutions of (10.12) satisfy (10.14). This happens when c goes to infinity “regularly” (the exact definition is given below). Regular growth means, roughly speaking, that a function does not increase fast on intervals of short length.

Here we show that both theorems extend verbatim to (9.1). First we present some definitions. Let $S := \{(\alpha_k, \beta_k)\}$ be a sequence of intervals such that

$$0 \leq \alpha_1 < \beta_1 < \alpha_2 < \beta_2 < \dots < \beta_k \rightarrow \infty \quad \text{as } k \rightarrow \infty. \tag{10.15}$$

Then

$$\limsup_{k \rightarrow \infty} \frac{\sum_{i=1}^k (\beta_i - \alpha_i)}{\beta_k} =: \delta(S) = \delta \tag{10.16}$$

is called the *density* of the sequence of intervals S . A nondecreasing positive function f tends to infinity *intermittently* (an alternative terminology is *quasi-jumping*) as $t \rightarrow \infty$,

provided to every $\varepsilon > 0$ there exists a sequence of intervals S satisfying (10.15) such that $\delta(S) \leq \varepsilon$ and the increase of f on $\mathbb{R}_+ \setminus S$ is finite, i.e.,

$$\mathcal{S}(f; S) := \sum_{k=1}^{\infty} [f(\alpha_k) - f(\beta_{k-1})] < \infty. \tag{10.17}$$

In the opposite case we say that $f(t) \rightarrow \infty$ regularly as $t \rightarrow \infty$.

THEOREM 10.2. *Suppose that c is a nondecreasing continuously differentiable function satisfying (10.13). Then (10.1) possesses at least one nontrivial solution satisfying (10.14).*

PROOF. From the variety of proofs we present that one based on the modified Prüfer transformation (compare Section 1.3). An alternative approach to the problem is presented in [107,108,123].

For any nontrivial solution x of (10.1) there exist a positive function ϱ given by the formula

$$\varrho = \left[|x|^p + \frac{1}{c} |x'|^p \right]^{\frac{1}{p}}$$

and a continuous function ϑ such that x can be expressed in the form

$$x(t) = \varrho(t)S(\vartheta(t)), \quad x'(t) = c^{\frac{1}{p}}(t)\varrho(t)S'(\vartheta(t)),$$

where the generalized sine function S is the same as in Section 1.3. The functions ϑ and ϱ satisfy the differential system

$$\vartheta' = c^{\frac{1}{p}}(t) + \frac{c'(t)}{c(t)}f(\vartheta(t)), \quad \frac{\varrho'}{\varrho} = -\frac{c'(t)}{c(t)}g(\vartheta(t)), \tag{10.18}$$

where

$$f(\vartheta) = \frac{1}{p}\Phi(S'(\vartheta))S(\vartheta), \quad g(\vartheta) = \frac{1}{p}|S'(\vartheta)|^p.$$

The right-hand side of (10.18) is Lipschitzian in ϑ hence the solution of (10.18) is uniquely determined by the initial condition. We denote by $\vartheta(t, \varphi)$, $\varrho(t, \varphi)$ the solution given by the initial condition $\vartheta(0) = \varphi$, $\varrho(0) = 1$. Then

$$\varrho(t, \varphi) = \exp \left\{ - \int_0^t \frac{c'(s)}{c(s)} g(\vartheta(s, \varphi)) ds \right\},$$

and since $g(\vartheta) \geq 0$, the function $\varrho(t, \vartheta)$ is nonincreasing and tends to a nonnegative limit $\varrho(\infty, \varphi)$ as $t \rightarrow \infty$. Obviously, $\varrho(\infty, \varphi) = 0$ implies that $x(t) \rightarrow 0$ as $t \rightarrow \infty$. The converse is also true because x is oscillatory.

We have the following two possibilities.

- (i) We have $\varrho(\infty, \varphi) = 0$, the corresponding solution x satisfies $x(t) \rightarrow 0$ as $t \rightarrow \infty$, and

$$\int_0^\infty \frac{c'(t)}{c(t)} g(\vartheta(t, \varphi)) dt = \infty,$$

- (ii) $\varrho(\infty, \varphi) > 0$, the solution x oscillates, its amplitude tends to a positive limit, and

$$\int_0^\infty \frac{c'(t)}{c(t)} g(\vartheta(t, \varphi)) dt < \infty. \tag{10.19}$$

Now, the proof is based on the behavior as $t \rightarrow \infty$ of the function $\psi(t, \varphi_1, \varphi_2) = \vartheta(t, \varphi_2) - \vartheta(t, \varphi_1)$ which is described in the next two auxiliary statements. Here \mathcal{X} denotes the set of φ 's such that (10.19) holds, this means that the corresponding solution does not tend to zero as $t \rightarrow \infty$. The proof can be found in [15].

LEMMA 10.1. *Let $\varphi_1, \varphi_2 \in \mathcal{X}$ and $\varphi_1 < \varphi_2 < \varphi_1 + \pi_p$. Then*

$$\psi(\infty, \varphi_1, \varphi_2) := \lim_{t \rightarrow \infty} [\vartheta(t, \varphi_2) - \vartheta(t, \varphi_1)]$$

exists and equals 0 or π_p .

LEMMA 10.2. *Let $\varphi_0 \in \mathcal{X}$. Then for any $\varepsilon > 0$ there exists $\eta \in (0, \pi_p)$ such that if $|\varphi - \varphi_0| < \eta$, then*

$$|\vartheta(t, \varphi) - \vartheta(t, \varphi_0)| < \varepsilon \quad \text{for } t \geq 0. \tag{10.20}$$

Now, returning to the proof of our theorem, suppose that $\mathcal{X} = \mathbb{R}$. Then the function φ given by $\psi(\infty, 0, \varphi) = 0$ is nondecreasing as φ increases in $[0, \pi_p]$. It must go from 0 to π_p , taking on only these two values, by Lemma 10.1. But this is impossible since by Lemma 10.2 this function is continuous, so the assumption $\mathcal{X} = \mathbb{R}$ was false and the theorem is proved. □

Now we turn our attention to the extension of the Armellini–Tonelli–Sansone theorem.

THEOREM 10.3. *If the function $\lg c(t) \rightarrow \infty$ regularly, then every solution of (10.1) satisfies (10.14).*

PROOF. For the sake of simplicity we suppose that c is continuously differentiable for large t . Consider the function

$$A(t) = |x(t)|^p + \frac{|x'(t)|^p}{c(t)},$$

where x is a nontrivial solution of (10.1). The function A is nondecreasing since

$$A'(t) = -\frac{c'(t)}{c^2(t)} |x'(t)|^p \leq 0. \quad (10.21)$$

Consequently, there exists a (finite or infinite) limit $A = \lim_{t \rightarrow \infty} A(t)$ and $A \geq 0$.

Suppose, by contradiction, that there exists a solution x of (10.1) which does not tend to zero. For this solution obviously $A > 0$. By (10.21)

$$\begin{aligned} A(t) &= A(0) - \int_0^t \frac{c'(s)}{c^2(s)} |x'(s)|^p ds \\ &= A(0) - \int_0^t \frac{c'(s)}{c(s)} (A(s) - |x(s)|^p) ds \\ &= A(0) - \int_0^t (A(s) - |x(s)|^p) \frac{dc(s)}{c(s)}. \end{aligned}$$

Let $\varepsilon > 0$ be a number such that for every sequence S_ε of intervals

$$S = \sum_{i=1}^k [\lg c(\alpha_{i+1}) - \lg c(\beta_i)] = \sum_{i=1}^k \lg \frac{c(\alpha_{i+1})}{c(\beta_i)} \rightarrow \infty \quad (10.22)$$

as $k \rightarrow \infty$.

In the remaining part of the proof we suppose that the following statement holds.

LEMMA 10.3. *For every $\varepsilon_0 > 0$ there exists $\eta > 0$ such that the density of the sequence S of all intervals where*

$$A(t) - |x(t)|^p \leq \eta \quad (10.23)$$

is less than ε_0 .

Since the proof of this lemma is rather technical and follows essentially the original linear idea, we skip it and return to the proof of theorem.

Denote by (α_i, β_i) intervals, where (10.23) holds. On intervals (β_i, α_{i+1}) we have

$$A(t) - |x(t)|^p > \eta,$$

therefore

$$A(\alpha_k) \leq A(0) - \sum_{i=1}^{k-1} \int_{\beta_i}^{\alpha_{i+1}} (A(t) - |x(t)|^p) \frac{dc(t)}{c(t)} < A(0) - \eta \sum_{i=1}^k \lg \frac{c(\alpha_{i+1})}{c(\beta_i)}$$

which implies by (10.22) that $A(\alpha_k)$ becomes negative for large k . This is a contradiction with $A = \lim_{t \rightarrow \infty} A(t) > 0$. \square

10.3. Strongly and conditionally oscillatory equation

Differential equation (0.1) with a *positive* function c is said to be *conditionally oscillatory* if there exists a constant $\lambda_0 > 0$ such that (0.1) with $\lambda c(t)$ instead of $c(t)$ is oscillatory for $\lambda > \lambda_0$ and nonoscillatory if $\lambda < \lambda_0$. The value λ_0 is called the *oscillation constant* of (0.1). If equation is oscillatory (nonoscillatory) for every $\lambda > 0$, then equation is said to be *strongly oscillatory (strongly nonoscillatory)*. The results of this subsection are presented in [133].

The examples illustrating these concepts we have already seen in the previous sections. For example, if $\int^\infty r^{1-q}(t) dt = \infty$, the equation

$$(r(t)\Phi(x'))' + \frac{r^{1-q}(t)}{(\int^t r^{1-q}(s) ds)^\mu} \Phi(x) = 0 \tag{10.24}$$

is conditionally oscillatory if $\mu = p$, strongly oscillatory if $\mu < p$ and strongly nonoscillatory if $\mu > p$. This follows from the fact that the transformation of independent variable $t \mapsto \int^t r^{1-q}(s) ds$ transforms (10.24) into the equation

$$(\Phi(x'))' + \frac{1}{t^\mu} \Phi(x) = 0 \tag{10.25}$$

and (10.25) is compared with the Euler equation (4.20).

THEOREM 10.4. *Suppose that $\int^\infty c(t) dt < \infty$ and $\int^\infty r^{1-q}(t) dt = \infty$. Equation (0.1) is strongly oscillatory if and only if*

$$\limsup_{t \rightarrow \infty} \left(\int^t r^{1-q}(s) ds \right)^{p-1} \int_t^\infty c(s) ds = \infty \tag{10.26}$$

and it strongly nonoscillatory if and only if

$$\lim_{t \rightarrow \infty} \left(\int^t r^{1-q}(s) ds \right)^{p-1} \int_t^\infty c(s) ds = 0. \tag{10.27}$$

PROOF. The proof is based on the statements which claim (upon a slight reformulation) that under the assumptions of our theorem Equation (0.1) is oscillatory provided

$$\liminf_{t \rightarrow \infty} \left(\int^t r^{1-q}(s) ds \right)^{p-1} \int_t^\infty c(s) ds > \frac{1}{p} \left(\frac{p-1}{p} \right)^{p-1} \tag{10.28}$$

or

$$\limsup_{t \rightarrow \infty} \left(\int^t r^{1-q}(s) ds \right)^{p-1} \int_t^\infty c(s) ds > 1 \tag{10.29}$$

and it is nonoscillatory provided

$$\left(\int_t^t r^{1-q}(s) ds \right)^{p-1} \int_t^\infty c(s) ds < \frac{1}{p} \left(\frac{p-1}{p} \right)^{p-1} \quad (10.30)$$

for large t . These statements follow essentially from comparing (0.1) with Euler-type differential equation, see, e.g., [60].

Suppose that (10.26) holds and $\lambda > 0$ is arbitrary. Then clearly

$$\limsup_{t \rightarrow \infty} \left(\int_t^\infty r^{1-q}(s) ds \right)^{p-1} \int_t^\infty \lambda c(s) ds > 1$$

hence (0.1) is strongly oscillatory. Conversely, suppose that (0.1) is strongly oscillatory and (10.26) fails to hold, i.e.,

$$\limsup_{t \rightarrow \infty} \left(\int_t^t r^{1-q}(s) ds \right)^{p-1} \int_t^\infty c(s) ds = L < \infty.$$

Then for $\lambda < \frac{1}{pL} \left(\frac{p-1}{p} \right)^{p-1}$ we have

$$\limsup_{t \rightarrow \infty} \left(\int_t^t r^{1-q}(s) ds \right)^{p-1} \int_t^\infty \lambda c(s) ds < \frac{1}{p} \left(\frac{p-1}{p} \right)^{p-1}$$

which means that (0.1) with λc instead of c is nonoscillatory. This contradicts strong oscillation of (0.1). The proof of the part concerning necessary and sufficient condition for strong nonoscillation of (0.1) is the same. \square

10.4. Oscillation of forced half-linear differential equations

The result of this subsection is presented in [158] and concerns the forced half-linear differential equation

$$(r(t)\Phi(x'))' + c(t)\Phi(x) = f(t), \quad (10.31)$$

where f is a continuous function. It extends the oscillation criterion of Wong [215] (see also references given therein) which concerns the linear forced equation. Oscillation of a more general half-linear forced equation than (10.31) is investigated in [139], but for simplicity we here the results of [158].

THEOREM 10.5. *Suppose that for any T there exist $T \leq s_1 < t_1 \leq s_2 < t_2$ such that $f(t) \leq 0$ for $t \in [s_1, t_1]$ and $f(t) \geq 0$ for $t \in [s_2, t_2]$. Denote*

$$D(s_i, t_i) = \{u \in C^1[s_i, t_i]: u(t) \neq 0, u(s_i) = 0 = u(t_i)\}, \quad i = 1, 2.$$

If there exists a function $h \in D(s_i, t_i)$ and a positive nondecreasing function $\varphi \in C^1[T, \infty)$ such that

$$\int_{s_i}^{t_i} h^2(t)\varphi(t)c(t) dt > \frac{1}{p^p} \int_{s_i}^{t_i} \frac{r(t)\varphi(t)}{|h(t)|^{p-2}} \left(2|h'(t)| + h(t)\frac{\varphi'(t)}{\varphi(t)} \right)^p dt,$$

for $i = 1, 2$, then every solution of (10.31) is oscillatory.

PROOF. Suppose that x is a nonoscillatory solution which is eventually of one sign, say $x(t) > 0$ for $t \geq T_0$ and let the function w be defined by the modified Riccati substitution

$$w(t) = \varphi(t) \frac{r(t)\Phi(x'(t))}{\Phi(x(t))}.$$

Then w solves the generalized Riccati equation

$$w' = -\varphi(t)c(t) + \frac{\varphi'(t)}{\varphi(t)}w - (p-1)\frac{|w|^q}{(r(t)\varphi(t))^{q-1}} + \frac{\varphi(t)f(t)}{\Phi(x(t))}. \tag{10.32}$$

By the assumptions of theorem, one can choose $s_1, t_1 \geq T_0$ so that $f(t) \leq 0$ on $I = [s_1, t_1]$ with $s_1 < t_1$. From (10.32) we have for $t \in I$

$$\varphi(t)c(t) \leq -w'(t) + \frac{\varphi'(t)}{\varphi(t)}w(t) - (p-1)\frac{|w(t)|^q}{(r(t)\varphi(t))^{q-1}}. \tag{10.33}$$

Multiplying (10.33) by h^2 and integrating over I we obtain

$$\begin{aligned} & \int_{s_1}^{t_1} h^2(t)\varphi(t)c(t) dt \\ & \leq - \int_{s_1}^{t_1} h^2(t)w'(t) dt + \int_{s_1}^{t_1} h^2(t)\frac{\varphi'(t)}{\varphi(t)}w(t) dt \\ & \quad - (p-1) \int_{s_1}^{t_1} \frac{|w(t)|^q}{(r(t)\varphi(t))^{q-1}} dt. \end{aligned}$$

Integrating the last inequality by parts and using the fact that $h(s_1) = 0 = h(t_1)$, we get

$$\begin{aligned} & \int_{s_1}^{t_1} h^2(t)\varphi(t)c(t) dt \\ & \leq \int_{s_1}^{t_1} 2|h(t)||h'(t)||w(t)| dt + \int_{s_1}^{t_1} h^2(t)\frac{\varphi'(t)}{\varphi(t)}w(t) dt \\ & \quad - (p-1) \int_{s_1}^{t_1} \frac{|w(t)|^q}{(r(t)\varphi(t))^{q-1}} dt \end{aligned}$$

$$\begin{aligned} &\leq \int_{s_1}^{t_1} \left(2|h(t)||h'(t)| + \frac{\varphi'(t)}{\varphi(t)}h^2(t) \right) |w(t)| dt \\ &\quad - (p-1) \int_{s_1}^{t_1} h^2(t) \frac{|w(t)|^q}{(r(t)\varphi(t))^{q-1}} dt. \end{aligned}$$

Now, the application of the Young inequality yields for $t \in [s_1, t_1]$

$$\begin{aligned} &\left(2|h(t)||h'(t)| + \frac{\varphi'(t)}{\varphi(t)}h^2(t) \right) |w(t)| - (p-1) \frac{|w(t)|^q}{(r(t)\varphi(t))^{q-1}} h^2(t) \\ &\leq \frac{1}{p^p} \frac{r(t)\varphi(t)}{|h(t)|^{p-2}} \left(2|h'(t)| + |h(t)| \frac{\varphi'(t)}{\varphi(t)} \right)^p, \end{aligned}$$

thus

$$\int_{s_1}^{t_1} h^2(t)\varphi(t)c(t) dt \leq \frac{1}{p^p} \int_{s_1}^{t_1} \frac{r(t)\varphi(t)}{|h(t)|^{p-2}} \left(2|h'(t)| + |h(t)| \frac{\varphi'(t)}{\varphi(t)} \right)^p dt,$$

which contradicts our assumption. When x is eventually negative, we may employ the fact that $f(t) \geq 0$ on some interval in any neighborhood of ∞ to reach a similar contradiction. □

10.5. Oscillation of retarded half-linear equations

The results of this subsection are given [4], for related results we refer also to [2,227] and the references given therein. We consider the equation

$$(\Phi(x'))' + c(t)\Phi(x(\tau(t))) = 0. \tag{10.34}$$

We suppose that $c(t) \geq 0$ for large t , $\lim_{t \rightarrow \infty} \tau(t) = \infty$ and $\tau(t) \leq t$. Equation (10.34) is said to be *oscillatory* if all its solutions are oscillatory, i.e., have arbitrarily large zeros. Since the Sturmian theory generally does not extend to (10.34), oscillatory and nonoscillatory solutions (i.e., solutions which are eventually positive or negative) may coexist.

In the next theorem, Equation (10.34) is considered on the interval $[t_0, \infty)$ and it is shown that if the delay $\tau(t)$ is sufficiently close to t , in a certain sense, then some oscillation criteria for (9.1) can be extended to (10.34). Oscillation criteria presented here are half-linear extensions of some results for the linear second order retarded equations (the case $p = 2$ in (10.34)) given in [96,184].

First we present without proof a technical auxiliary statement, the proof can be found in [4].

LEMMA 10.4. *Suppose that the following conditions hold:*

- (i) $x(t) \in C^2[T, \infty)$ for some $T > 0$,
- (ii) $x(t) > 0$, $x'(t) > 0$, and $x''(t) \leq 0$ for $t \geq T$.

Then for each $k_1 \in (0, 1)$ there exists a constant $T_{k_1} \geq T$ such that

$$x(\tau(t)) \geq \frac{k_1 \tau(t)}{t} x(t), \quad \text{for } t \geq T_{k_1},$$

and for every $k_2 \in (0, 1)$ there exists a constant $T_{k_2} \geq T$ such that

$$x(t) \geq k_2 t x'(t), \quad \text{for } t \geq T_{k_2}.$$

THEOREM 10.6. Denote for $t \geq t_0$

$$\gamma(t) := \sup\{s \geq t_0: \tau(s) \leq t\}.$$

Equation (10.34) is oscillatory if either of the following holds:

$$\limsup_{t \rightarrow \infty} t^{p-1} \int_t^\infty c(s) \left(\frac{\tau(s)}{s}\right)^{p-1} ds > 1, \tag{10.35}$$

or

$$\limsup_{t \rightarrow \infty} t^{p-1} \int_{\gamma(t)}^\infty c(s) ds = \infty. \tag{10.36}$$

PROOF. Suppose to the contrary that (10.34) has a nonoscillatory solution $x(t)$. Without loss of generality we may suppose that $x(t) > 0$ for large t , say $t \geq t_1$. Then also $x(\tau(t)) > 0$ on $[t_1, \infty)$ for t_1 large enough. Since $c(t) \geq 0$ on $[t_1, \infty)$,

$$(\Phi(x'))' = -c(t)(\Phi(x(\tau(t)))) \leq 0. \tag{10.37}$$

Hence, the function $\Phi(x')$ is decreasing. Since $\sup\{c(t): t \geq T\} > 0$ for any $T \geq 0$, we see that either

- (a) $x'(t) > 0$ for all $t \geq t_1$, or
- (b) there exists $t_2 \geq t_1$ such that $x'(t) < 0$ on $[t_2, \infty)$.

If (b) holds, then it follows from (10.37) that

$$0 \geq [|x'(t)|^{p-2} x'(t)]' = (p-1)|x'(t)|^{p-2} x''(t), \quad \text{for } t \geq t_2.$$

Thus, $x''(t) \leq 0$ for $t \in [t_2, \infty)$. This and $x'(t) < 0$ on $[t_2, \infty)$ imply that there exists $t_3 > t_2$ such that $x(t) \leq 0$ for $t \geq t_3$. This contradicts $x(t) > 0$. Thus, (a) holds.

Integrating (10.37) from $t \geq t_1$ to ∞ , we obtain

$$\begin{aligned} - \int_t^\infty c(s) \Phi(x(\tau(s))) ds &= \int_t^\infty (\Phi(x'(s)))' ds = \int_t^\infty ([x'(s)]^{p-1})' ds \\ &= \lim_{s \rightarrow \infty} [x'(s)]^{p-1} - [x'(t)]^{p-1}. \end{aligned}$$

Since $x'(t) > 0$ for $t \geq t_1$, we find

$$\begin{aligned}
 [x'(t)]^{p-1} &= \lim_{s \rightarrow \infty} [x'(s)]^{p-1} + \int_t^\infty c(s)\Phi(x(\tau(s))) \, ds \\
 &\geq \int_t^\infty c(s)[x(\tau(s))]^{p-1} \, ds.
 \end{aligned}
 \tag{10.38}$$

It follows from (ii) of Lemma 10.4 that, for each $k_2 \in (0, 1)$, there exists a $T_{k_2} \geq t_1$ such that

$$[x(t)]^{p-1} \geq k_2^{p-1} t^{p-1} [x'(t)]^{p-1} \geq k_2^{p-1} t^{p-1} \int_t^\infty c(s)[x(\tau(s))]^{p-1} \, ds,
 \tag{10.39}$$

for $t \geq T_{k_2}$. By (i) of Lemma 10.4, for each $k_1 \in (0, 1)$, there exists a T_{k_1} , such that

$$[x(\tau(s))]^{p-1} \geq k_1^{p-1} \left(\frac{\tau(t)}{t}\right)^{p-1} (x(t))^{p-1},
 \tag{10.40}$$

for $t \geq T_{k_1}$. Then, by (10.39) and (10.40), for $t \geq t_4 := \max\{T_{k_1}, T_{k_2}\}$,

$$\begin{aligned}
 [x(t)]^{p-1} &\geq k_2^{p-1} t^{p-1} \int_t^\infty c(s)[x(\tau(s))]^{p-1} \, ds \\
 &\geq k_1^{p-1} k_2^{p-1} t^{p-1} \int_t^\infty c(s) \left(\frac{\tau(s)}{s}\right)^{p-1} [x(s)]^{p-1} \, ds \\
 &\geq k^{2(p-1)} t^{p-1} \int_t^\infty c(s) \left(\frac{\tau(s)}{s}\right)^{p-1} [x(s)]^{p-1} \, ds,
 \end{aligned}
 \tag{10.41}$$

where $k := \min\{k_1, k_2\}$. Since $x'(t) > 0$, it follows that

$$\begin{aligned}
 1 &\geq \frac{k^{2p-2} t^{p-1}}{[x(t)]^{p-1}} \int_t^\infty c(s) \left(\frac{\tau(s)}{s}\right)^{p-1} [x(s)]^{p-1} \, ds \\
 &\geq k^{2p-2} t^{p-1} \int_t^\infty c(s) \left(\frac{\tau(s)}{s}\right)^{p-1} \, ds, \quad \text{for } t \geq t_4.
 \end{aligned}
 \tag{10.42}$$

Hence,

$$\limsup_{t \rightarrow \infty} t^{p-1} \int_t^\infty c(s) \left(\frac{\tau(s)}{s}\right)^{p-1} \, ds := a < \infty.$$

Suppose that (10.35) holds, then there exists a sequence $\{s_n\}$ such that $\lim_{n \rightarrow \infty} s_n = \infty$ and

$$\lim_{n \rightarrow \infty} s_n^{p-1} \int_{s_n}^{\infty} c(s) \left(\frac{\tau(s)}{s} \right)^{p-1} ds = a > 1.$$

For $\varepsilon_1 := (a - 1)/2 > 0$, there exists an integer $N_1 > 0$ such that

$$\frac{a + 1}{2} = a - \varepsilon_1 < s_n^{p-1} \int_{s_n}^{\infty} c(s) \left(\frac{\tau(s)}{s} \right)^{p-1} ds, \tag{10.43}$$

for $n > N_1$. Choose k such that

$$\left(\frac{2}{a + 1} \right)^{1/2(p-1)} < k < 1.$$

By (10.42) and (10.43),

$$1 \geq k^{2(p-1)} s_n^{p-1} \int_{s_n}^{\infty} c(s) \left(\frac{\tau(s)}{s} \right)^{p-1} ds > \left(\frac{2}{a + 1} \right) \left(\frac{a + 1}{2} \right) = 1,$$

for s_n large enough. This contradiction shows that (10.35) does not hold.

Now, by $\gamma(t) \geq t$ and (10.39), we have

$$[x(t)]^{p-1} \geq k_2^{p-1} t^{p-1} \int_{\gamma(t)}^{\infty} c(s) [x(\tau(s))]^{p-1} ds,$$

for $t \geq T_{k_2}$. Since $x(t)$ is increasing and $\tau(s) \geq t$ for $s \geq \gamma(t)$, it follows that

$$\begin{aligned} [x(t)]^{p-1} &\geq k_2^{p-1} t^{p-1} \int_{\gamma(t)}^{\infty} c(s) [x(\tau(s))]^{p-1} ds \\ &\geq k_2^{p-1} t^{p-1} [x(t)]^{p-1} \int_{\gamma(t)}^{\infty} c(s) ds. \end{aligned}$$

Dividing $[x(t)]^{p-1}$ in both sides of the above inequality, we get

$$k_2^{p-1} t^{p-1} \int_{\gamma(t)}^{\infty} c(s) ds \leq 1, \tag{10.44}$$

for $t \geq T_{k_2}$. Thus,

$$\limsup_{t \rightarrow \infty} t^{p-1} \int_{\gamma(t)}^{\infty} c(s) ds := b < \infty.$$

Suppose that (10.36) holds. Then there exists a sequence $\{t_n\}$ with $\lim_{n \rightarrow \infty} t_n = \infty$ such that

$$\lim_{n \rightarrow \infty} t_n^{p-1} \int_{\gamma(t_n)}^{\infty} c(s) \, ds = b > 1.$$

Thus, for $\varepsilon_2 := (b - 1)/2 > 0$, there exists an integer $N_2 > 0$ such that

$$\frac{b + 1}{2} = b - \varepsilon_2 < t_n^{p-1} \int_{\gamma(t_n)}^{\infty} c(s) \, ds, \tag{10.45}$$

for $n > N_2$. Choose $k_2 \in (\frac{2}{(b+1)^{q-1}}, 1)$. By (10.44) and (10.45),

$$1 \geq k_2^{p-1} t_q^{p-1} \int_{\gamma(t_n)}^{\infty} c(s) \, ds > \frac{2}{b+1} \frac{b+1}{2} = 1,$$

for t_n large enough. This contradiction proves that (10.36) does not hold. □

EXAMPLE 10.2. Consider the functional differential equation

$$[\Phi(x')] + \frac{2^p(p-1)}{t^p} \Phi(x(t/2)) = 0. \tag{10.46}$$

Since

$$\begin{aligned} & \limsup_{t \rightarrow \infty} t^{p-1} \int_t^{\infty} \frac{2^p(p-1)}{s^p} \left(\frac{(s/2)}{s}\right)^{p-1} \, ds \\ &= 2(p-1) \limsup_{t \rightarrow \infty} t^{p-1} \int_t^{\infty} \frac{1}{s^p} \, ds \\ &= 2(p-1) \limsup_{t \rightarrow \infty} t^{p-1} \left(\frac{1}{(p-1)t^{p-1}}\right) = 2 > 1, \end{aligned}$$

it follows from (10.35) of Theorem 10.6 that (10.46) is oscillatory. In fact, if the coefficient $\frac{2^p(p-1)}{t^p}$ of (10.46) is replaced by $\frac{k}{t^p}$ with $k > 2^{p-1}(p-1)$, (10.46) will again be oscillatory.

In the next theorem we assume that $\tau(t) > 0$ and we denote

$$\mu(t) = \left(\frac{\tau(t)}{t}\right)^{p-1}.$$

THEOREM 10.7. Equation (10.34) is oscillatory if the differential equation

$$(\Phi(x')) + \lambda \mu(t)c(t)\Phi(x) = 0 \tag{10.47}$$

is oscillatory for some $\lambda \in (0, 1)$.

PROOF. By contradiction, suppose that there exists eventually positive solution x of (10.34) and we may also assume that $x(\tau(t)) > 0$ on $[t_1, \infty)$ for some $t_1 \geq t_0$. Then $x''(t) \leq 0$, $x'(t) > 0$ on $[t_2, \infty)$ for some $t_2 \geq t_1$. Since $\lambda \in (0, 1)$, it follows from (a) of Lemma 10.4 that

$$x(\tau(t)) \geq \lambda^{1/(p-1)} x(t) \frac{\tau(t)}{t},$$

for t large enough. Thus,

$$[x(\tau(t))]^{p-1} \geq \lambda [x(t)]^{p-1} \left(\frac{\tau(t)}{t}\right)^{p-1}, \tag{10.48}$$

for t large enough. Let

$$w(t) = \frac{\Phi(x'(t))}{\Phi(x(t))}.$$

Then, by (10.48),

$$\begin{aligned} w'(t) + \frac{\lambda[\tau(t)]^{p-1}}{t^{p-1}}c(t) + (p-1)|w(t)|^q &= \frac{[(x'(t))^{p-1}]'[x(t)]^{p-1} - [x'(t)]^{p-1}[(x(t))^{p-1}]'}{[(x(t))^{p-1}]^2} \\ &+ \frac{\lambda(\tau(t))^{p-1}}{t^{p-1}}c(t) + (p-1)\left(\frac{[x'(t)]^{p-1}}{[x(t)]^{p-1}}\right)^q \\ &= \frac{[(x'(t))^{p-1}]'[x(t)]^{p-1} - (p-1)[x'(t)]^{p-1}[x(t)]^{p-2}x'(t)}{[(x(t))^{p-1}]^2} \\ &+ \frac{\lambda(\tau(t))^{p-1}}{t^{p-1}}c(t) + \frac{(p-1)[x'(t)]^p}{[x(t)]^p} \\ &= \frac{[(x'(t))^{p-1}]'}{[x(t)]^{p-1}} - \frac{(p-1)[x'(t)]^p}{[x(t)]^p} + \frac{\lambda(\tau(t))^{p-1}}{t^{p-1}}c(t) + \frac{(p-1)[x'(t)]^p}{[x(t)]^p} \\ &= \frac{-c(t)|x(\tau(t))|^{p-2}x(\tau(t))}{[x(t)]^{p-1}} + \frac{\lambda(\tau(t))^{p-1}c(t)}{t^{p-1}} \\ &= \frac{c(t)}{[x(t)]^{p-1}} \left(\frac{\lambda[\tau(t)]^{p-1}}{t^{p-1}} [x(t)]^{p-1} - [x(\tau(t))]^{p-1} \right) \\ &\leq 0. \end{aligned}$$

This and Theorem 5.3 imply that (10.47) is nonoscillatory, but this is a contradiction. Hence, (10.34) is oscillatory. \square

REMARK 10.2. Theorem 10.7 is an extension of Theorem 2.2 of [96].

THEOREM 10.8. *If*

$$\limsup_{t \rightarrow \infty} \int^t c(s) \left(\frac{\tau(s)}{s} \right)^{p-1} ds = \infty, \quad (10.49)$$

then Equation (10.34) is oscillatory.

PROOF. Suppose to the contrary that (10.34) has a nonoscillatory solution $x(t)$ which may be assumed to be eventually positive. As in the proof of Theorem 10.6, there exists $t_1 > t_0$ such that $x(\tau(t)) > 0$, $x'(t) > 0$, and $x''(t) < 0$ for $t > t_1$. By (i) of Lemma 10.4, there exists $t_2 \geq t_1$ such that

$$x(\tau(t)) \geq \left(\frac{1}{2} \right)^{1/(p-1)} \frac{\tau(t)}{t} x(t),$$

or

$$(x(\tau(t)))^{p-1} \geq \frac{1}{2} \left(\frac{\tau(t)}{t} \right)^{p-1} [x(t)]^{p-1}$$

for $t \geq t_2$. Since $x'(t) > 0$ and $x(\tau(t)) > 0$ for $t \geq t_1$,

$$-((x'(t))^{p-1})' = c(t)[x(\tau(t))]^{p-1} \geq \frac{1}{2} c(t) \left(\frac{\tau(t)}{t} \right)^{p-1} [x(t)]^{p-1}$$

for $t \geq t_2$. Integrating the above inequality from t_2 to t and using the increasing property of $x(t)$, we get

$$\begin{aligned} [x'(t)]^{p-1} - [x'(t_2)]^{p-1} &\leq -\frac{1}{2} \int_{t_2}^t c(s) \left(\frac{\tau(s)}{s} \right)^{p-1} [x(s)]^{p-1} ds \\ &\leq -\frac{1}{2} [x(t_2)]^{p-1} \int_{t_2}^t c(s) \left(\frac{\tau(s)}{s} \right)^{p-1} ds, \end{aligned}$$

or

$$[x'(t)]^{p-1} \leq [x'(t_2)]^{p-1} - \frac{1}{2} [x(t_2)]^{p-1} \int_{t_2}^t c(s) \left(\frac{\tau(s)}{s} \right)^{p-1} ds$$

for $t \geq t_2$. This and (10.49) imply $[x'(t)]^{p-1} < 0$ for t large enough. This is a contradiction. Thus, (10.34) is oscillatory. \square

EXAMPLE 10.3. Consider the functional differential equation

$$[\Phi(x'(t))] + \Phi(x(t/2)) = 0 \quad (10.50)$$

where $p > 1$. Clearly,

$$\limsup_{t \rightarrow \infty} \int^t \left(\frac{(s/2)}{s} \right)^{p-1} ds = \frac{1}{2^{p-1}} \limsup_{t \rightarrow \infty} \int^t ds = \infty.$$

Thus, it follows from Theorem 10.8 that (10.50) is oscillatory.

11. Half-linear Sturm–Liouville problem

In this section we show that the solutions of the Sturm–Liouville problem for half-linear equation (0.1) have similar properties as in the linear case. Of course, we cannot consider the problem of orthogonality of eigenfunctions since this concept has no meaning in L^p , $p \neq 2$. As far as we know, an open problem is whether the system of eigenfunctions is complete in L^p .

11.1. Basic Sturm–Liouville problem

We start with the problem

$$(\Phi(x'))' + \lambda c(t)\Phi(x) = 0, \quad x(a) = 0 = x(b), \quad (11.1)$$

under the assumption that $c(t) \geq 0$ and $c(t) \not\equiv 0$. The value λ is called the *eigenvalue* if there exists a nontrivial solution x of (11.1). The solution x is said to be the *eigenfunction* corresponding to the eigenvalue λ . Clearly, according to the assumption $c(t) \geq 0$ and the Sturm comparison theorem, only values $\lambda > 0$ can be eigenvalues. The main statement of this subsection is taken from the classical paper of Elbert [85].

THEOREM 11.1. *The eigenvalue problem (11.1) has infinitely many eigenvalues $0 < \lambda_1 < \lambda_2 < \dots < \lambda_n < \dots$, $\lambda_n \rightarrow \infty$ as $n \rightarrow \infty$. The n th eigenfunction has exactly $n - 1$ zeros in (a, b) . Moreover, if the function c is supposed to be positive in the whole interval (a, b) , the eigenvalues satisfy the asymptotic relation*

$$\lim_{n \rightarrow \infty} \frac{\sqrt[p]{\lambda_n}}{n} = \frac{\pi_p}{\int_a^b \sqrt[p]{c(t)} dt}. \quad (11.2)$$

PROOF. The proof of the first part of the theorem is a special case of the problem treated in the next subsection, so we present only its main idea. Let $x(t; \lambda)$ be a solution of (11.1)

given by the initial condition $x(a; \lambda) = 0$, $x'(a; \lambda) = 1$ and let $\varphi(t; \lambda)$ be the continuous function given in all points where $x'(t; \lambda) \neq 0$ by the formula

$$\varphi(t; \lambda) = \arctan_p \frac{x(t; \lambda)}{x'(t; \lambda)},$$

i.e., $\varphi(t; \lambda)$ is the angular variable in the half-linear Prüfer transformation for $x(t; \lambda)$. This means that $\varphi(t; \lambda)$ satisfy the differential equation

$$\varphi' = |S'(\varphi)|^p + \frac{\lambda c(t)}{p-1} |S(\varphi)|^p, \quad \varphi(a; \lambda) = 0, \quad (11.3)$$

where S is the half-linear sine function. The proof is based on the fact that $\varphi(b; \lambda)$ is a continuous function of λ and $\varphi(b; \lambda) \rightarrow \infty$ as $\lambda \rightarrow \infty$. The continuity property follows from the general theory of continuous dependence of solutions of first order differential equations on the right-hand side. The limit property of $\varphi(b; \lambda)$ is proved via the comparison of (11.1) with the “minorant” problem with a constant coefficient

$$(\Phi(y'))' + \lambda \bar{c} \Phi(y) = 0, \quad y(a') = 0 = y(b'), \quad (11.4)$$

where $[a', b'] \subset [a, b]$ is such that $c(t) > 0$ on $[a', b']$ and $\bar{c} = \min_{t \in [a', b']} c(t) > 0$. The eigenvalues and eigenfunctions of (11.4) can be computed explicitly and if $\theta(t; \lambda)$ is defined for this problem in the same way as $\varphi(t; \lambda)$ for (11.1), we have

$$\varphi(b; \lambda) \geq \theta(b; \lambda) \rightarrow \infty, \quad \text{as } \lambda \rightarrow \infty.$$

Now, the eigenvalues are those $\lambda = \lambda_n$ for which $\varphi(b; \lambda_n) = n\pi_p$ and taking into account that $\varphi(t; \lambda)$ is increasing in t (this follows from (11.3)), zero points of the associated eigenfunction $x_n(t) = x(t; \lambda_n)$ are those t_k , $k = 1, \dots, n-1$, for which $\varphi(t_k, \lambda_n) = k\pi_p$, $k = 1, \dots, n-1$.

Concerning the proof of the asymptotic formula (11.2), first suppose that the function $c(t) \equiv c_1 > 0$ is a constant function and consider the problem

$$(\Phi(z'))' + \lambda c_1 \Phi(z) = 0, \quad z(a) = 0 = z(b). \quad (11.5)$$

A nontrivial solution of the half-linear equation in this problem satisfying $z(a) = 0$ is $z = S(\sqrt[p]{\lambda c_1}(t-a))$ and hence the k -th eigenvalue is given by $\sqrt[p]{\lambda_k c_1}(b-a) = k\pi_p$, thus

$$\frac{\sqrt[p]{\lambda_k}}{k} = \frac{\pi_p}{\int_a^b \sqrt[p]{c_1} dt},$$

i.e., the asymptotic formula (11.2) is automatically satisfied in this case.

Now let us consider the original Sturm–Liouville problem (11.1) and its k -th eigenfunction $x(t; \lambda_k)$. This function has zeros at $t_0 = a < t_1 < t_2 < \dots < t_{k-1} < t_k = b$. Put $\lambda = \lambda_k$ in (11.1) and in (11.5) and define

$$c_{1,i} := \min_{t_{i-1} \leq t \leq t_i} c(t), \quad c_{2,i} := \max_{t_{i-1} \leq t \leq t_i} c(t), \quad i = 1, \dots, k.$$

Then the differential equation in (11.1) is a Sturmian majorant of the differential equation in (11.5) with $c_1 = c_{1,i}$ on the interval $[t_{i-1}, t_i]$. Hence the solution $S(\sqrt[p]{\lambda_k c_{1,i}}(t - t_{i-1}))$ of (11.5) has no zero on (t_{i-1}, t_i) so that

$$\sqrt[p]{\lambda_k c_{1,i}}(t_i - t_{i-1}) \leq \pi_p. \tag{11.6}$$

By a similar argument we have $\pi_p \leq \sqrt[p]{\lambda_k c_{2,i}}(t_i - t_{i-1})$. On the other hand,

$$\int_{t_{i-1}}^{t_i} \sqrt[p]{\lambda_k c_{1,i}} dt \leq \int_{t_{i-1}}^{t_i} \sqrt[p]{\lambda_k c(t)} dt \leq \int_{t_{i-1}}^{t_i} \sqrt[p]{\lambda_k c_{2,i}} dt,$$

and consequently

$$\left| \pi_p - \int_{t_{i-1}}^{t_i} \sqrt[p]{\lambda_k c(t)} dt \right| \leq \int_{t_{i-1}}^{t_i} \sqrt[p]{\lambda_k} (\sqrt[p]{c_{2,i}} - \sqrt[p]{c_{1,i}}) dt. \tag{11.7}$$

Let $\omega(f, \delta)$ be defined for any continuous function f on $[a, b]$ by

$$\omega(f, \delta) = \max\{|f(\tau_1) - f(\tau_2)| : |\tau_1 - \tau_2| \leq \delta, \tau_1, \tau_2 \in [a, b]\}.$$

Making use of this definition we deduce from (11.7) that

$$\left| \frac{\pi_p}{\sqrt[p]{\lambda_k}} - \int_{t_{i-1}}^{t_i} \sqrt[p]{c(t)} dt \right| \leq \omega(\sqrt[p]{c}, t_i - t_{i-1})|t_i - t_{i-1}|.$$

Let $c_1 = \min_{i=1, \dots, k} c_{1,i}$. Then by (11.6)

$$\left| \frac{k\pi_p}{\sqrt[p]{\lambda_k}} - \int_a^b \sqrt[p]{c(t)} dt \right| \leq \omega\left(\sqrt[p]{c}, \frac{\pi_p}{\sqrt[p]{\lambda_k c_1}}\right)(b - a).$$

By the first part of the proof $\lambda_k \rightarrow \infty$ as $k \rightarrow \infty$. Therefore the continuity of the function c yields the formula which has to be proved. □

11.2. Regular problem with indefinite weight

The results presented in this subsection can be found in [133]. We consider the Sturm-Liouville problem

$$\begin{cases} (r(t)\Phi(x'))' + \lambda c(t)\Phi(x) = 0, \\ Ax(a) - A'x'(a) = 0, \quad Bx(b) + B'x'(b) = 0. \end{cases} \tag{11.8}$$

It is supposed that r, c are continuous in $[a, b]$ and $r(t) > 0$ in this interval. No sign restriction on the function c is supposed. A, A', B, B' are real numbers such that $A^2 + A'^2 > 0, B^2 + B'^2 > 0, \lambda$ is a real-valued eigenvalue parameter.

THEOREM 11.2. *Suppose that $AA' \geq 0$, $BB' \geq 0$ and $A^2 + B^2 > 0$. Further suppose that the function c takes both positive and negative values in $[a, b]$. Then the totality of eigenvalues of (11.8) consists of two sequences $\{\lambda_n^+\}_{n=0}^\infty$ and $\{\lambda_n^-\}_{n=0}^\infty$ such that*

$$\dots < \lambda_n^- < \dots < \lambda_1^- < \lambda_0^- < 0 < \lambda_0^+ < \lambda_1^+ < \dots < \lambda_n^+ < \dots$$

and

$$\lim_{n \rightarrow \infty} \lambda_n^+ = \infty, \quad \lim_{n \rightarrow \infty} \lambda_n^- = -\infty.$$

The eigenfunctions $x = x(t; \lambda_n^+)$ and $x = x(t; \lambda_n^-)$ associated with $\lambda = \lambda_n^+$ and λ_n^- have exactly n zeros in (a, b) .

PROOF. The proof is again based on the half-linear Prüfer transformation. Let $\lambda \in \mathbb{R}$ and let $x(t; \lambda)$ be the solution of

$$(r(t)\Phi(x'))' + \lambda c(t)\Phi(x) = 0 \tag{11.9}$$

satisfying the initial conditions $x(a) = A'$, $x'(a) = A$. Note that this solution satisfies the boundary condition $Ax(a) - A'x'(a) = 0$. According to the continuous dependence of solutions on a perturbation of the functions r, c , in (0.1), the function $x(t; \lambda)$ depends continuously on λ . In particular, if $\lambda_i \rightarrow \lambda$ as $i \rightarrow \infty$, then $x(t; \lambda_i) \rightarrow x(t; \lambda)$ uniformly on $[a, b]$ as $i \rightarrow \infty$. If $x(t; \lambda)$ satisfies the second part of the boundary conditions $Bx(b) + B'x'(b) = 0$ for some $\lambda \in \mathbb{R}$, then λ is an eigenvalue and $x(t; \lambda)$ is the corresponding eigenfunction.

For $\lambda = 0$ we can compute $x(t; \lambda)$ explicitly,

$$x(t; 0) = A' + r^{q-1}(a)A \int_a^t r^{1-q}(s) ds$$

and it is easy to see that this solution does not satisfy the condition at $t = b$, so $\lambda = 0$ is not an eigenvalue.

In what follows we suppose that $\lambda > 0$. For the solution $x(t; \lambda)$ we perform slightly modified Prüfer transformation, we express $x(t; \lambda)$ and its quasiderivative in the form

$$\begin{aligned} x(t; \lambda) &= \rho(t; \lambda)S(\varphi(t; \lambda)), \\ r^{q-1}(t)x'(t; \lambda) &= \lambda^{q-1}\rho(t; \lambda)C(\varphi(t; \lambda)). \end{aligned} \tag{11.10}$$

Here S, C are the generalized half-linear sine and cosine functions introduced in Section 1.1. The function $\rho(t; \lambda)$ is given by

$$\rho(t; \lambda) = \left[|x(t; \lambda)|^p + \left(\frac{r(t)}{\lambda} \right)^q |x'(t; \lambda)|^p \right]^{\frac{1}{p}}.$$

The functions ρ and φ satisfy the first order system

$$\begin{aligned} \varphi' &= \left(\frac{\lambda}{r(t)}\right)^{q-1} |C(\varphi)|^p + \frac{c(t)}{p-1} |S(\varphi)|^p, \\ \rho' &= \rho \left[\left(\frac{\lambda}{r(t)}\right)^{q-1} - \frac{c(t)}{p-1} \right] \Phi(S(\varphi))C(\varphi) \end{aligned} \tag{11.11}$$

with the initial conditions

$$\begin{aligned} \rho(a; \lambda) &= \left[|A|^p + \left(\frac{r(a)}{\lambda}\right)^q |A|^p \right]^{\frac{1}{p}}, \\ \varphi(a; \lambda) &= \arctan_p \left(\left(\frac{\lambda}{r(a)}\right)^{\frac{1}{p}} \frac{A'}{A} \right), \end{aligned} \tag{11.12}$$

where $\tan_p = S/C = \sin_p / \cos_p$. Since $AA' \geq 0$, we may assume without loss of generality that

$$0 \leq \varphi(a; \lambda) < \frac{\pi_p}{2}, \quad \text{if } A \neq 0, \tag{11.13}$$

$$\varphi(a, \lambda) = \frac{\pi_p}{2}, \quad \text{if } A = 0. \tag{11.14}$$

Observe that as soon as $\varphi(t; \lambda)$ is known, $\rho = \rho(t; \lambda)$ can be computed explicitly and

$$\rho(t; \lambda) = \rho(a, \lambda) \exp \left\{ \int_a^t \left[\left(\frac{\lambda}{r(s)}\right)^{q-1} - \frac{c(s)}{p-1} \right] \Phi(S(\varphi(s; \lambda)))C(\varphi(s; \lambda)) ds \right\}.$$

Thus, it is important to discuss the initial value problem (11.11), (11.12). We denote by $f(t, \varphi, \lambda)$ the right-hand side of (11.11). It is clear that, for each $\lambda > 0$, the function $f(t, \varphi, \lambda)$ is bounded for $t \in [a, b]$ and $\varphi \in \mathbb{R}$. In view of the Pythagorean identity (1.5) the function $f(t, \varphi, \lambda)$ can be written in the form

$$f(t, \varphi, \lambda) = \left(\frac{\lambda}{r(t)}\right)^{q-1} + \left\{ -\left(\frac{\lambda}{r(t)}\right)^{q-1} + \frac{c(t)}{p-1} \right\} |S(\varphi)|^p.$$

Similarly as in the standard half-linear Prüfer transformation, the function $f(t, \varphi, \lambda)$ is Lipschitzian in φ , hence unique solvability is guaranteed and the solution $\varphi = \varphi(t; \lambda)$ depends continuously on $(t, \lambda) \in [a, b] \times (0, \infty)$.

It is easy to see that $\lambda > 0$ is an eigenvalue of (11.8) if and only if λ satisfies

$$\varphi(b; \lambda) = \arctan_p \left(-\left(\frac{\lambda}{r(b)}\right)^{q-1} \frac{B'}{B} \right) + (n+1)\pi_p \tag{11.15}$$

for some $n \in \mathbb{Z}$. Here, by virtue of $BB' \geq 0$, we assume without loss of generality that the value of the function \arctan_p in (11.15) is in $(-\pi_p/2, 0]$ if $B \neq 0$ and equals $-\pi_p/2$ if $B = 0$.

Observe that the function $\varphi(b; \lambda)$ is strictly increasing for $\lambda \in (0, \infty)$. Indeed, denote as before $f(t, \varphi, \lambda)$ the right-hand side of (11.11). Clearly, $f(t, \varphi, \lambda)$ is nondecreasing function of $\lambda \in (0, \infty)$, and, since $AA' \geq 0$, the initial value $\varphi(a; \lambda)$ given by (11.12) is also nondecreasing for $\lambda \in (0, \infty)$. Then a standard comparison theorem for the first order scalar differential equations implies that $\varphi(t; \lambda)$ is a nondecreasing function of $\lambda \in (0, \infty)$ for each fixed $t \in [a, b]$. Now, let $0 < \lambda < \mu$ be fixed. Since the function $\varphi(t; \lambda)$ is nondecreasing with respect to λ , we have $\varphi(t; \lambda) \leq \varphi(t; \mu)$. Assume that $\varphi(t; \lambda) \equiv \varphi(t; \mu)$ for all $t \in (a, b)$. Then $\varphi'(t; \lambda) \equiv \varphi'(t; \mu)$, and so we have $f(t, \varphi(t; \lambda), \lambda) \equiv f(t, \varphi(t; \mu), \mu)$ from which follows $C(\varphi(t; \lambda)) \equiv C(\varphi(t; \mu)) \equiv 0$. This implies that $\varphi(t; \lambda) \equiv (m + \frac{1}{2})\pi_p$ for some integer $m \in \mathbb{Z}$, and hence, by Equation (11.11), $c(t) \equiv 0$ for $t \in (a, b)$. This is a contradiction to the assumption that $c(t) > 0$ for some $t \in [a, b]$. Therefore we have $\varphi(t_0; \lambda) < \varphi(t_0; \mu)$ for some $t_0 \in (a, b)$. Then applying a standard comparison theorem again, we conclude that $\varphi(b; \lambda) < \varphi(b; \mu)$.

Now we claim that $x(t; \lambda)$ has no zeros in the interval $(a, b]$ for all sufficiently small $\lambda > 0$. As stated before, $x(t; \lambda) \rightarrow x(t; 0)$ as $\lambda \rightarrow 0+$ uniformly on $[a, b]$. We note that $x(t; \lambda)$ satisfies

$$x(t; \lambda) = A' + \int_a^t \left| \frac{r(a)}{r(s)} \Phi(A) - \frac{\lambda}{r(s)} I(s; \lambda) \right|^{q-2} \times \left\{ \frac{r(a)}{r(s)} \Phi(A) - \frac{\lambda}{r(s)} I(s; \lambda) \right\} ds,$$

for all $a \leq t \leq b$, where

$$I(s; \lambda) = \int_a^s c(\tau) \Phi(x(\tau; \lambda)) d\tau, \quad a \leq s \leq b.$$

Then it is easy to find that if $A = 0$ or $AA' > 0$, then $x(t; \lambda)$ has no zero in the closed interval $[a, b]$ for all sufficiently small $\lambda > 0$, and that if $A \neq 0$ and $A' = 0$, then $x(t; \lambda)$ has no zero in the interval $(a, b]$ for all sufficiently small $\lambda > 0$. Further, since

$$r(t) \Phi(x'(t; \lambda)) = r(a) \Phi(A) - \lambda \int_a^t c(s) \Phi(x(s; \lambda)) ds$$

for $a \leq t \leq b$, we see that if $A \neq 0$, then $x'(t; \lambda)$ has no zeros in $[a, b]$ for all sufficiently small $\lambda > 0$.

Next we claim that the number of zeros of $x(t; \lambda)$ in $[a, b]$ can be made as large as possible if $\lambda > 0$ is chosen sufficiently large. To this end, we consider the equation

$$(\Phi(x'))' + (p - 1)\mu^p \Phi(x) = 0,$$

where $\mu > 0$ is a constant. Clearly, $S(\mu t)$ is a solution of this equation, and has zeros $t = j\pi_p/\mu$, $j \in \mathbb{Z}$, $S(\cdot)$ is the generalized sine function. Since c is supposed to be positive

at some $t \in [a, b]$, there exists $[a', b'] \subset [a, b]$ such that $c(t) > 0$ on $[a', b']$. Let $k \in \mathbb{N}$ be any given positive integer and take $\mu > 0$ so that $S(\mu t)$ has at least $k + 1$ zeros in $[a', b']$. Let $r^* > 0$ and $\lambda_* > 0$ be numbers such that

$$r^* = \max_{t \in [a', b']} r(t), \quad \lambda_* \min_{t \in [a', b']} c(t) = (p - 1)r^* \mu^p.$$

Then, comparing the half-linear equation in (11.8) with $\lambda > \lambda_*$ and the equation

$$(r^* \Phi(x'))' + (p - 1)r^* \mu^p \Phi(x) = 0, \quad a' \leq t \leq b',$$

we conclude by the Sturm comparison theorem that all solution of the equation in (11.8) with $\lambda > \lambda_*$ have at least k zeros in $[a, b]$. Since k was arbitrary, this shows that the number of zeros of $x(t; \lambda)$ in $[a, b]$ can be made as large as possible if $\lambda > 0$ is chosen sufficiently large.

Since the radial variable $\rho(t; \lambda) > 0$, it follows from (11.10) that $x(t; \lambda)$ has a zero at $t = c$ if and only if there exists $j \in \mathbb{Z}$ such that $\varphi(c; \lambda) = j\pi_p$. Moreover, if $\varphi(c; \lambda) = j\pi_p$, then by (11.11) we have $\varphi'(c; \lambda) = (\lambda/r(c))^{q-1} > 0$. Therefore we easily see that if $\varphi(c; \lambda) = j\pi_p$, then $\varphi(t; \lambda) > j\pi_p$ for $c < t \leq b$. Consequently, we have

(i) For all $\lambda > 0$ sufficiently small

$$0 < \varphi(b; \lambda) < \frac{\pi_p}{2}, \quad \text{if } A \neq 0,$$

$$0 < \varphi(b; \lambda) < \pi_p, \quad \text{if } A = 0.$$

(ii) $\lim_{\lambda \rightarrow \infty} \varphi(b; \lambda) = \infty$.

Now we seek $\lambda > 0$ satisfying (11.15) for some $n \in \mathbb{Z}$. The left-hand side $\varphi(b; \lambda)$ of (11.15) is a continuous function of $\lambda \in (0, \infty)$, and it is strictly increasing for $\lambda \in (0, \infty)$, moreover, it has the following properties

$$0 \leq \lim_{\lambda \rightarrow 0^+} \varphi(b; \lambda) < \frac{\pi_p}{2}, \quad \text{if } A \neq 0,$$

$$0 \leq \lim_{\lambda \rightarrow 0^+} \varphi(b; \lambda) < \pi_p, \quad \text{if } A = 0,$$

and

$$\lim_{\lambda \rightarrow \infty} \varphi(b; \lambda) = \infty.$$

On the other hand, by virtue of $BB' \geq 0$, the right-hand side of (11.15) is a nonincreasing function of $\lambda \in (0, \infty)$ for each $n \in \mathbb{Z}$. More precisely, in case $BB' > 0$, it is strictly decreasing and varies from $(n + 1)\pi_p$ to $(n + \frac{1}{2})\pi_p$ as λ varies from 0 to ∞ . In the case $B' = 0$, it is the constant function $(n + \frac{1}{2})\pi_p$.

From what was observed above we find that, for each $n = 0, 1, 2, \dots$, there exists a unique $\lambda_n^+ > 0$ such that

$$\varphi(b; \lambda_n^+) = \arctan_p \left(- \left(\frac{\lambda_n^+}{r(b)} \right)^{q-1} \frac{B'}{B} \right) + (n + 1)\pi_p.$$

Then, each λ_n^+ is an eigenvalue of (11.8), and the associated eigenfunction $x(t; \lambda_n^+)$ has exactly n zeros in the open interval (a, b) , where $n = 0, 1, 2, \dots$. It is clear that

$$\lambda_0^+ < \lambda_1^+ < \dots < \lambda_n^+ < \dots, \quad \lim_{n \rightarrow \infty} \lambda_n^+ = \infty.$$

The proof concerning the sequence of negative eigenvalues λ_n^- and the number of zeros of associated eigenfunctions can be proved in the same way. □

11.3. Singular Sturm–Liouville problem

The results of this subsection are taken from the paper [91], for related results we refer to [133,134]. We consider the equation

$$(\Phi(x'))' + \lambda c(t)\Phi(x) = 0, \quad t \in [a, \infty), \tag{11.16}$$

where $\lambda > 0$ is a real-valued parameter and c is a nonnegative piecewise continuous eventually nonvanishing function. A solution $x_0 = x_0(t; \lambda)$ of (11.16) is said to be *subdominant* if

$$\lim_{t \rightarrow \infty} x_0(t; \lambda) = k_0, \tag{11.17}$$

for some constant $k_0 \neq 0$, and a solution $x_1 = x_1(t; \lambda)$ is said to be *dominant* if

$$\lim_{t \rightarrow \infty} [x_1(t; \lambda) - k_1(t - a)] = 0 \tag{11.18}$$

for some constant $k_1 \neq 0$. We will show that the subdominant and dominant solutions are essentially unique in the sense that if $\tilde{x}_0(t; \lambda)$ and $\tilde{x}_1(t; \lambda)$ denote the solutions of (11.16) satisfying

$$\lim_{t \rightarrow \infty} \tilde{x}_0(t; \lambda) = 1 \tag{11.19}$$

and

$$\lim_{t \rightarrow \infty} [\tilde{x}_1(t; \lambda) - (t - a)] = 0 \tag{11.20}$$

then $x_0(t; \lambda) = k_0 \tilde{x}_0(t; \lambda)$ and $x_1(t; \lambda) = k_1 \tilde{x}_1(t; \lambda)$. According to the results presented in Section 6, any eventually positive solution (11.16) has one of the following asymptotic behavior:

- (i) $\lim_{t \rightarrow \infty} \Phi(x'(t; \lambda)) = \text{const} > 0$;
- (ii) $\lim_{t \rightarrow \infty} \Phi(x'(t; \lambda)) = 0, \lim_{t \rightarrow \infty} x(t; \lambda) = 0$;
- (iii) $\lim_{t \rightarrow \infty} \Phi(x'(t; \lambda)) = 0, \lim_{t \rightarrow \infty} x(t; \lambda) = \text{const} > 0$.

In view of this result, the dominant and subdominant solutions investigated in this subsection correspond to cases (i) and (iii), respectively.

The proofs of three statements presented in this subsection are rather complex, so we skip them and we refer to the above mentioned paper [91]. We note only that these proofs are again based on the half-linear Prüfer transformation, this time combined with a detailed asymptotic analysis of solutions of (11.16).

THEOREM 11.3. *Suppose that*

$$\int_t^\infty \left(\int_t^\infty c(s) ds \right)^{q-1} dt < \infty.$$

Then for every λ Equation (11.16) has a unique solution $\tilde{x}_0(t; \lambda)$ satisfying (11.19) and there exists a sequence $\{\lambda_n^{(0)}\}_{n=0}^\infty$ of positive parameters with the properties that

- (i) $0 = \lambda_0^{(0)} < \lambda_1^{(0)} < \dots < \lambda_n^{(0)} < \dots, \lim_{n \rightarrow \infty} \lambda_n^{(0)} = \infty$;
- (ii) *for $\lambda \in (\lambda_{n-1}^{(0)}, \lambda_n^{(0)})$, $n = 1, 2, \dots$, $\tilde{x}_0(t; \lambda)$ has exactly $n - 1$ zeros in (a, ∞) and $\tilde{x}_0(a; \lambda) \neq 0$;*
- (iii) *for $\lambda = \lambda_n^{(0)}$, $n = 1, 2, \dots$, $\tilde{x}_0(t; \lambda)$ has exactly $n - 1$ zeros in (a, ∞) and $\tilde{x}_0(a; \lambda) = 0$.*

THEOREM 11.4. *Let the sequence $\{\lambda_n^{(0)}\}_{n=0}^\infty$ be defined as in the previous theorem. Then the number of zeros of any nontrivial solution $x(t; \lambda)$ on $[a, \infty)$ can be*

- (i) *exactly n if $\lambda = \lambda_n^{(0)}$, $n = 1, 2, \dots$;*
- (ii) *either $n - 1$ or n if $\lambda_{n-1}^{(0)} < \lambda < \lambda_n^{(0)}$, and both cases occur.*

THEOREM 11.5. *Suppose that*

$$\int_t^\infty t^p c(t) dt < \infty.$$

Then for every $\lambda > 0$ Equation (11.16) has a unique solution $\tilde{x}_1(t; \lambda)$ satisfying (11.20) and there exists a sequence $\{\lambda_n^{(1)}\}_{n=0}^\infty$ of positive parameters with the properties that

- (i) $0 = \lambda_0^{(1)} < \lambda_1^{(1)} < \dots < \lambda_n^{(1)} < \dots, \lim_{n \rightarrow \infty} \lambda_n^{(1)} = \infty$;
- (ii) *for $\lambda \in (\lambda_{n-1}^{(1)}, \lambda_n^{(1)})$, $n = 1, 2, \dots$, the solution $\tilde{x}_1(t; \lambda)$ has exactly n zeros in (a, ∞) and $\tilde{x}_1(t; \lambda) \neq 0$;*
- (iii) *for $\lambda = \lambda_n^{(1)}$, $n = 1, 2, \dots$, the solution $\tilde{x}_1(t; \lambda)$ has exactly n zeros and $\tilde{x}_1(a; \lambda) = 0$;*
- (iv) *the parameters $\{\lambda_n^{(0)}\}$ and $\{\lambda_n^{(1)}\}$ have the interlacing property $0 = \lambda_0^{(1)} = \lambda_0^{(0)} < \lambda_1^{(1)} < \lambda_1^{(0)} < \dots < \lambda_n^{(1)} < \lambda_n^{(0)} < \dots$.*

12. Perturbation principle

12.1. General idea

In the previous sections devoted to oscillation and nonoscillation criteria for (0.1), this equation was essentially viewed as a perturbation of the one-term equation

$$(r(t)\Phi(x'))' = 0. \quad (12.1)$$

As we have already mentioned, for oscillation (nonoscillation) of (0.1), the function c must be “sufficiently positive” (“not too positive”) comparing with the function r . In this section we use a more general approach, Equation (0.1) is investigated as a perturbation of another (nonoscillatory) *two-term* half-linear equation

$$(r(t)\Phi(x'))' + \tilde{c}(t)\Phi(x) = 0 \quad (12.2)$$

with a continuous function \tilde{c} , i.e., (0.1) is written in the form

$$(r(t)\Phi(x'))' + \tilde{c}(t)\Phi(x) + (c(t) - \tilde{c}(t))\Phi(x) = 0. \quad (12.3)$$

The main idea is essentially the same as before. If the difference $(c - \tilde{c})$ is sufficiently positive (not too positive), then (12.3) becomes oscillatory (remains nonoscillatory).

Note that in the linear case $p = 2$, the idea to investigate the linear Sturm–Liouville equation (1.1) as a perturbation of the nonoscillatory two-term equation

$$(r(t)x')' + \tilde{c}(t)x = 0 \quad (12.4)$$

(and not only as a perturbation of the one-term equation $(r(t)x')' = 0$) brings essentially no new idea. Indeed, let us write (1.1) in the “perturbed” form

$$(r(t)x')' + \tilde{c}(t)x + (c(t) - \tilde{c}(t))x = 0. \quad (12.5)$$

Further, let h be a solution of (12.4) and consider the transformation $x = h(t)u$. This transformation transforms (12.5) into the equation

$$(r(t)h^2(t)u')' + [c(t) - \tilde{c}(t)]h^2(t)u = 0 \quad (12.6)$$

(compare (3.2)) and this equation, whose oscillatory properties are the same as those of (1.1), can be again investigated as a perturbation of the one-term equation $(r(t)h^2(t)u')' = 0$. In the half-linear case we have in disposal no transformation which reduces nonoscillatory two-terms equation into a one-term equation, so we have to use different methods and this “perturbation principle” brings new phenomena. Note also that some ideas used in this section have already been applied in Section 8.

12.2. Leighton–Wintner type oscillation criterion

Recall that if $\int^\infty r^{1-q}(t) dt = \infty$ and $\int^\infty c(t) dt = \infty$, then (0.1) is oscillatory. This direct extension of the classical linear Leighton–Wintner criterion has been proved in Section 2. This criterion characterizes exactly what means that for oscillation of (0.1) the function c must be sufficiently positive comparing with the function r in one-term equation (12.1). Here we extend this result to the situation when (0.1) is investigated as a perturbation of (12.2). The results of this subsection are presented in [69].

THEOREM 12.1. *Suppose that h is the principal solution of (nonoscillatory) equation (12.2) and*

$$\int^\infty (c(t) - \tilde{c}(t))h^p(t) dt := \lim_{b \rightarrow \infty} \int^b (c(t) - \tilde{c}(t))h^p(t) dt = \infty. \tag{12.7}$$

Then Equation (0.1) is oscillatory.

PROOF. According to the relationship between disconjugacy of (0.1) and positivity of the functional \mathcal{F} mentioned in Section 2, to prove that (0.1) is oscillatory, it suffices to find (for any $T \in \mathbb{R}$) a function $y \in W^{1,p}(T, \infty)$, with a compact support in (T, ∞) , such that $\mathcal{F}(y; T, \infty) < 0$. Hence, let $T \in \mathbb{R}$ be arbitrary and $T < t_0 < t_1 < t_2 < t_3$ (these points will be specified later). Define the test function y as follows.

$$y(t) = \begin{cases} 0, & T \leq t \leq t_0, \\ f(t), & t_0 \leq t \leq t_1, \\ h(t), & t_1 \leq t \leq t_2, \\ g(t), & t_2 \leq t \leq t_3, \\ 0, & t_3 \leq t < \infty, \end{cases}$$

where f, g are solutions of (12.2) given by the boundary conditions $f(t_0) = 0, f(t_1) = h(t_1), g(t_2) = h(t_2), g(t_3) = 0$. Denote

$$w_f := \frac{r\Phi_p(f')}{\Phi_p(f)}, \quad w_h := \frac{r\Phi_p(h')}{\Phi_p(h)}, \quad w_g := \frac{r\Phi_p(g')}{\Phi_p(g)},$$

i.e., w_f, w_g, w_h are solutions of the Riccati equation associated with (12.2) generated by f, g, h respectively. Using exactly the same computations as in the proof of Theorem 1 from [58], one can show that

$$\mathcal{F}(y; T, \infty) = K - \int_{t_1}^{\xi} (c(t) - \tilde{c}(t))h^p(t) dt + h^p(t_2)[w_h(t_2) - w_g(t_2)], \tag{12.8}$$

where

$$K := \mathcal{F}(f; t_0, t_1) + h^p(t_1)[w_f(t_1) - w_h(t_1)]$$

and $\xi \in (t_2, t_3)$. Now, if $\varepsilon > 0$ is arbitrary and $T < t_0 < t_1$ are fixed, then, according to (12.7), t_2 can be chosen in such a way that $\int_{t_1}^t (c(s) - \tilde{c}(s))h^p(s) ds > K + \varepsilon$ whenever $t > t_2$. Finally, again using the same argument as in [58] we have (observe that w_g actually depends also on t_3)

$$\lim_{t_3 \rightarrow \infty} h^p(t_2)[w_h(t_2) - w_g(t_2)] = 0,$$

hence the last summand in (12.8) is less than ε if t_3 is sufficiently large. Consequently, $\mathcal{F}(y; t_0, t_3) < 0$ if t_0, t_1, t_2, t_3 are chosen in the above specified way. \square

If $r(t) \equiv 1$ in (0.1) and $\tilde{c}(t) = \frac{\tilde{\gamma}}{t^p}$, $\tilde{\gamma} = (\frac{p-1}{p})^p$, i.e., (12.2) is the generalized Euler equation with the critical coefficient (4.20), then the previous theorem reduces to the oscillation criterion given by Elbert [87].

12.3. Hille–Nehari-type oscillation criterion

The results of this subsection can be viewed as an extension of Theorems 5.4 and 5.9 to the situation when (0.1) (or (6.16)) is viewed as a perturbation of a one-term equation.

THEOREM 12.2. *Let $\int^\infty r^{1-q}(t) dt = \infty$ and $c(t) \geq 0$ for large t . Further suppose that equation (12.2) is nonoscillatory and possesses a positive solution h satisfying*

- (i) $h'(t) > 0$ for large t ;
- (ii) it holds

$$\int^\infty r(t)(h'(t))^p dt = \infty; \tag{12.9}$$

- (iii) there exists a finite limit

$$\lim_{t \rightarrow \infty} r(t)h(t)\Phi(h'(t)) =: L > 0. \tag{12.10}$$

Denote by

$$G(t) = \int \frac{ds}{r(s)h^2(s)(h'(s))^{p-2}} \tag{12.11}$$

and suppose that the integral

$$\int^\infty (c(t) - \tilde{c}(t))h^p(t) dt = \lim_{b \rightarrow \infty} \int^b (c(t) - \tilde{c}(t))h^p(t) dt \tag{12.12}$$

is convergent. If

$$\liminf_{t \rightarrow \infty} G(t) \int_t^\infty (c(s) - \tilde{c}(s))h^p(s) \, ds > \frac{1}{2q} \tag{12.13}$$

then Equation (0.1) is oscillatory.

PROOF. Suppose, by contradiction, that (0.1) is nonoscillatory, i.e., there exists an eventually positive principal solution x of this equation. Denote by $\rho := r(t) \frac{\Phi(x')}{\Phi(x)}$. Then ρ satisfies the Riccati equation (2.1) and using the Picone identity for half-linear equations (2.5) we have

$$\begin{aligned} & \int_T^t (r(s)|y'|^p - c(s)|y|^p) \, ds \\ &= \rho(s)|y|^p|_T^t + p \int_T^t r^{1-q}(s)P(r^{q-1}y', \rho\Phi(y)) \, ds \end{aligned}$$

for any differentiable function y , where P is given by (2.6), and integration by parts yields

$$\begin{aligned} & \int_T^t [r(s)|y'|^p - c(s)|y|^p] \, ds \\ &= \int_T^t [r(s)|y'|^p - \tilde{c}(s)|y|^p] \, ds - \int_T^t (c(s) - \tilde{c}(s))|y|^p \, ds \\ &= r(s)y\Phi(y')|_T^t - \int_T^t y[(r(s)\Phi(y'))' - \tilde{c}(s)\Phi(y)] \, ds \\ &\quad - \int_T^t (c(s) - \tilde{c}(s))|y|^p \, ds. \end{aligned}$$

Substituting $y = h$ into the last two equalities (h being a solution of (12.2) satisfying the assumptions (i)–(iii) of theorem), we get

$$h^p(\tilde{\rho} - \rho)|_T^t = \int_T^t (c(s) - \tilde{c}(s))h^p \, ds + p \int_T^t r^{1-q}(s)P(r^{q-1}h', \rho\Phi(h)) \, ds, \tag{12.14}$$

where $\tilde{\rho} = \frac{r\Phi(h')}{\Phi(h)}$. Since $\int^\infty r^{1-q}(t) \, dt = \infty$, $w \equiv 0$ is the distinguished solution of the Riccati equation corresponding to the equation $(r(t)\Phi(x'))' = 0$ and since $c(t) \geq 0$, by Theorem 7.2 $\rho(t) \geq 0$ eventually. Hence, with L given by (12.10), we have

$$\begin{aligned} & L + h^p(T)(\rho(T) - \tilde{\rho}(T)) \\ & \geq \int_T^t (c(s) - \tilde{c}(s))h^p \, ds + p \int_T^t r^{1-q}(s)P(r^{q-1}h', \rho\Phi(h)) \, ds, \end{aligned}$$

and since $P(u, v) \geq 0$, this means that

$$\int^\infty r^{1-q}(t)P(r^{q-1}(t)h'(t), \rho(t)\Phi(h(t))) dt < \infty. \tag{12.15}$$

Now, since (12.10), (12.12), (12.15) hold, from (12.14) it follows that there exists a finite limit

$$\lim_{t \rightarrow \infty} h^p(t)(\rho(t) - \tilde{\rho}(t)) =: \beta$$

and also the limit

$$\lim_{t \rightarrow \infty} \frac{\rho(t)}{\tilde{\rho}(t)} = \lim_{t \rightarrow \infty} \frac{h^p(t)\rho(t)}{h^p(t)\tilde{\rho}(t)} = \frac{L + \beta}{L}. \tag{12.16}$$

Therefore,

$$h^p(t)(\rho(t) - \tilde{\rho}(t)) - \beta = C(t) + p \int_t^\infty r^{1-q}(s)P(r^{q-1}h', \rho\Phi(h)) ds,$$

where $C(t) = \int_t^\infty (c(s) - \tilde{c}(s))h^p(s) ds$.

Concerning the function $P(u, v)$, we have for $u, v > 0$

$$P(u, v) = \frac{u^p}{p} - uv + \frac{v^q}{q} = u^p \left(\frac{1}{q} \frac{v^q}{u^p} - vu^{1-p} + \frac{1}{p} \right) = u^p Q(vu^{1-p}), \tag{12.17}$$

where $Q(\lambda) = \frac{1}{q}\lambda^q - \lambda + \frac{1}{p}$ for $\lambda \geq 0$ with equality if and only if $\lambda = 1$ and

$$\lim_{\lambda \rightarrow 1} \frac{Q(\lambda)}{(\lambda - 1)^2} = \frac{q - 1}{2}. \tag{12.18}$$

Hence for every $\varepsilon > 0$ there exists $\delta > 0$ such that

$$P(u, v) \geq \left(\frac{q - 1}{2} - \varepsilon \right) u^p \left(\frac{v}{u^{p-1}} - 1 \right)^2, \tag{12.19}$$

whenever $|vu^{1-p} - 1| < \delta$. This implies that $\beta = 0$ in (12.16) since the case $\beta \neq 0$ contradicts the divergence of $\int^\infty r(t)(h'(t))^{p-1} dt$. If we denote

$$f(t) := h^p(t)(\rho(t) - \tilde{\rho}(t)), \quad H(t) := \frac{1}{r(t)h^2(t)(h'(t))^{p-2}},$$

then using

$$\begin{aligned} f(t) &\geq C(t) + \left(\frac{p(q-1)}{2} - \tilde{\varepsilon}\right) \int_t^\infty r(s)(h'(s))^p \left(\frac{\rho(s)}{\tilde{\rho}(s)} - 1\right)^2 ds \\ &= C(t) + \left(\frac{q}{2} - \tilde{\varepsilon}\right) \int_t^\infty H(s)f^2(s) ds, \end{aligned} \tag{12.20}$$

where $\tilde{\varepsilon} = p\varepsilon$. Multiplying (12.20) by $G(t)$ we get

$$G(t)f(t) \geq G(t)C(t) + \left(\frac{q}{2} - \tilde{\varepsilon}\right)G(t) \int_t^\infty H(s)f^2(s) ds. \tag{12.21}$$

Inequality (12.21) together with (12.13) imply that there exists a $\tilde{\delta} > 0$ such that

$$G(t)f(t) \geq \frac{1}{2q} + \tilde{\delta} + \left(\frac{q}{2} - \tilde{\varepsilon}\right)G(t) \int_t^\infty \frac{H(s)}{G^2(s)} [G(s)f(s)]^2 ds \tag{12.22}$$

for large t .

Suppose first that $\liminf_{t \rightarrow \infty} G(t)f(t) =: c < \infty$. Then for every $\bar{\varepsilon} > 0$ we have $[G(t)f(t)]^2 > (1 - \bar{\varepsilon})c^2$ for large t and (12.22) implies

$$c \geq \frac{1}{2q} + \tilde{\delta} + \left(\frac{q}{2} - \tilde{\varepsilon}\right)(1 - \bar{\varepsilon})c^2.$$

Now, letting $\tilde{\varepsilon}, \bar{\varepsilon} \rightarrow 0$ we have

$$c \geq \frac{1}{2q} + \tilde{\delta} + \frac{q}{2}c^2,$$

but this is impossible since $1 - 2q(\frac{1}{2q} + \tilde{\delta}) < 0$.

Finally, if

$$\liminf_{t \rightarrow \infty} G(t)f(t) = \infty, \tag{12.23}$$

denote by $m(t) = \inf_{t \leq s} \{G(s)f(s)\}$. Then m is nondecreasing and (12.22) implies that

$$G(t)f(t) \geq K + \left(\frac{q}{2} - \tilde{\varepsilon}\right)m^2(t),$$

where $K = \frac{1}{2q} + \tilde{\delta}$. Since m is nondecreasing, we have for $s > t$

$$G(s)f(s) \geq K + \left(\frac{q}{2} - \tilde{\varepsilon}\right)m^2(s) \geq K + \left(\frac{q}{2} - \tilde{\varepsilon}\right)m^2(t), \quad t \leq s,$$

and hence

$$m(t) \geq K + \left(\frac{q}{2} - \tilde{\varepsilon}\right)m^2(t)$$

which contradicts (12.23). The proof is complete. \square

When (12.3) reduces to the below given Euler-type equation (12.24), some technical assumptions on the function h in the previous theorem are satisfied and Theorem 12.2 simplifies as follows.

COROLLARY 12.1. *Let $r(t) \equiv 1$, $c(t) \geq 0$ and*

$$\tilde{c}(t) = \frac{\tilde{\gamma}}{t^p}, \quad \tilde{\gamma} = \left(\frac{p-1}{p}\right)^p.$$

Then (12.3) is the generalized Euler equation with the critical coefficient

$$(\Phi(y'))' + \frac{\tilde{\gamma}}{t^p}\Phi(y) = 0 \tag{12.24}$$

and the solution $h(t) = t^{\frac{p-1}{p}}$ of this equation satisfies all assumptions of Theorem 12.2 with

$$G(t) = \left(\frac{p}{p-1}\right)^{p-2} \lg t.$$

Hence Equation (9.1) is oscillatory provided

$$\liminf_{t \rightarrow \infty} \lg t \int_t^\infty s^{p-1} \left[c(s) - \frac{\gamma_0}{s^p} \right] ds > \frac{1}{2} \left(\frac{p-1}{p}\right)^{p-1}.$$

12.4. Hille–Nehari-type nonoscillation criterion

Now we turn our attention to a nonoscillation criterion which is proved under no sign restriction on the function c and also under no assumption concerning divergence of the integral $\int^\infty r^{1-q}(t) dt$ (compare Theorem 12.2).

THEOREM 12.3. *Suppose that Equation (12.2) is nonoscillatory and possesses a solution h satisfying (i), (iii) of Theorem 12.2. Moreover, suppose that*

$$\int^\infty \frac{dt}{r(t)h^2(t)(h'(t))^{p-2}} = \infty. \tag{12.25}$$

If $G(t)$ is the same as in Theorem 12.2 and

$$\limsup_{t \rightarrow \infty} G(t) \int_t^\infty (c(s) - \tilde{c}(s))h^p(s) ds < \frac{1}{2q} \tag{12.26}$$

and

$$\liminf_{t \rightarrow \infty} G(t) \int_t^\infty (c(s) - \tilde{c}(s))h^p(s) ds > -\frac{3}{2q}, \tag{12.27}$$

then (0.1) is nonoscillatory.

PROOF. Denote again

$$C(t) = \int_t^\infty (c(s) - \tilde{c}(s))h^p(s) ds.$$

To prove that (0.1) is nonoscillatory, according to Section 5.3 it suffices to find a differentiable function ρ which verifies the differential inequality (5.4) for large t . This inequality can be written in the form (with $w = h^{-p}(\rho + C)$)

$$\begin{aligned} \rho' &\leq -p \left[\frac{1}{q} \left| \frac{\rho + C}{h} \right|^q r^{1-q} - h' \left(\frac{\rho + C}{h} \right) + \frac{r(h')^p}{p} \right] + r(h')^p - \tilde{c}(t)h^p \\ &= -pr^{1-q} \left[\frac{1}{q} \left| \frac{\rho + C}{h} \right|^q - r^{q-1}h' \left(\frac{\rho + C}{h} \right) + \frac{1}{p}r^q(h')^p \right] + r(h')^p - \tilde{c}h^p \\ &= -pr^{1-q} P \left(r^{q-1}h', \frac{\rho + C}{h} \right) + r(h')^p - \tilde{c}h^p. \end{aligned}$$

We will show that the function

$$\rho(t) = r(t)h(t)\Phi(h'(t)) + \frac{1}{2qG(t)} \tag{12.28}$$

satisfies this inequality for large t . To this end, let $v = \frac{\rho+C}{h}$, $u = r^{q-1}h'$. The fact that the solution h of (12.2) is increasing together with (12.25), (12.26), (12.27) and the assumption (iii) of Theorem 12.2 imply that

$$\frac{v}{\Phi(u)} = \frac{\rho(t) + C(t)}{h(t)r(t)\Phi(h'(t))} = 1 + \frac{1 + 2qC(t)G(t)}{2qG(t)r(t)h(t)\Phi(h'(t))} \rightarrow 1$$

as $t \rightarrow \infty$. Hence, using (12.17) and the same argument as in the proof of Theorem 12.2, for any $\varepsilon > 0$, we have (with Q satisfying (12.18))

$$pr^{1-q} \left[\frac{1}{q} \left| \frac{\rho + C}{h} \right|^q - h'r^{q-1} \left(\frac{\rho + C}{h} \right) + \frac{r^q(h')^p}{p} \right]$$

$$\begin{aligned}
 &= pr^{1-q}r^q(h')^p Q\left(\frac{\rho + C}{hr\Phi(h')}\right) \\
 &\leq p\left(\frac{q-1}{2} + \varepsilon\right)r(h')^p \frac{(1+2qGC)^2}{4q^2r^2h^2(h')^{2p-2}G^2} \\
 &= \left(\frac{q}{2} + p\varepsilon\right)\frac{1}{rh^2(h')^{p-2}} \frac{(1+2qGC)^2}{4G^2q^2}
 \end{aligned}$$

as $t \rightarrow \infty$.

Now, since (12.26), (12.27) hold, there exists $\delta > 0$ such that

$$\frac{-3 + \delta}{2q} < G(t)C(t) < \frac{1 - \delta}{2q} \iff |1 + 2qG(t)C(t)| < 2 - \delta$$

for large t , hence $\varepsilon > 0$ can be chosen in such a way that

$$\left(\frac{q}{2} + \varepsilon\right)\frac{(1+2qG(t)C(t))^2}{4q^2} < \frac{1}{2q}$$

for large t . Consequently (using the fact that h solves (12.2)), we have

$$\begin{aligned}
 &-pr^{1-q}\left[\frac{1}{q}\left|\frac{\rho + C}{h}\right|^q - r^{q-1}h'\left(\frac{\rho + C}{h}\right) + \frac{r(h')^p}{p}\right] + r(h')^p - \tilde{c}(t)h^p \\
 &\geq -\left(\frac{q}{2} + \varepsilon\right)\frac{1}{G^2rh^2(h')^{p-2}} \frac{(1+2qGC)^2}{4q^2} + r(h')^p - \tilde{c}(t)h^p \\
 &> -\frac{1}{2qG^2rh^2(h')^{p-2}} + [rh\Phi(h')] = \left[rh\Phi(h') + \frac{1}{2qG}\right]' = \rho'.
 \end{aligned}$$

The proof is complete. □

COROLLARY 12.2. *If (12.2) is the generalized Euler equation (12.24) then by the previous theorem Equation (9.1) is nonoscillatory provided*

$$\limsup_{t \rightarrow \infty} \lg t \int_t^\infty \left(c(s) - \frac{\gamma}{s^p}\right) s^{p-1} ds < \frac{1}{2} \left(\frac{p-1}{p}\right)^{p-1}$$

and

$$\liminf_{t \rightarrow \infty} \lg t \int_t^\infty \left(c(s) - \frac{\gamma}{s^p}\right) s^{p-1} ds > -\frac{3}{2} \left(\frac{p-1}{p}\right)^{p-1}.$$

12.5. Perturbed Euler equation

The results of this subsection can be found in the paper [94]. If we distinguish the cases $p \in (1, 2]$ and $p \geq 2$, the following refinement of oscillation and nonoscillation criteria from

the previous subsection can be proved. We present the main results of [94] here without proofs since these proofs need several technical lemmata.

THEOREM 12.4. *Consider the half-linear equation*

$$(\Phi(x'))' + \frac{\tilde{\gamma}}{t^p} \Phi(x) + 2 \left(\frac{p-1}{p} \right)^{p-1} \frac{\delta(t)}{t^p} \Phi(x) = 0, \quad \tilde{\gamma} = \left(\frac{p-1}{p} \right)^p, \quad (12.29)$$

and the linear second order equation

$$(ty')' + \frac{\delta(t)}{t} y = 0. \quad (12.30)$$

Suppose that the integral

$$\sigma(t) := \int_t^\infty \frac{\delta(s)}{s} ds$$

is convergent and $\sigma(t) \geq 0$ for large t .

- (i) Let $p \geq 2$ and (12.30) is nonoscillatory. Then (12.29) is also nonoscillatory.
- (ii) Let $p \in (1, 2]$ and half-linear equation (12.29) is nonoscillatory. Then linear equation (12.30) is also nonoscillatory.

This Page Intentionally Left Blank

Related Equations and Problems

In this chapter we discuss various problems related to the oscillation theory of half-linear differential equations. First we deal with boundary value problems associated with (0.1), where a particular attention is focused to the half-linear Fredholm alternative. In Section 14 we briefly mention the so-called quasilinear equations, i.e., equations, where in addition to additivity, also homogeneity of the solution space of equations is lost. Section 15 is devoted to partial differential equations with p -Laplacian and the last section of this chapter presents basic facts of the oscillation theory of half-linear difference equations.

13. Half-linear boundary value problems

There is a voluminous literature dealing with boundary value problems of the form

$$(\Phi(x'))' + g(t, x) = h(t), \quad x(0) = 0 = x(\pi_p), \quad (13.1)$$

(or some other boundary conditions, e.g., periodic, Neuman, mixed, . . .) and even a brief survey of these results exceeds the scope of this treatment. For this reason we focus our attention only to some particular boundary value problems. We refer to [52,53,73,76,77, 80,82,164–168] as to a sample of papers dealing with half-linear boundary value problems.

13.1. Basic boundary value problem

Under the “basic” boundary value problem we understand the problem

$$\begin{cases} (\Phi(x'))' + \lambda\Phi(x) = 0, \\ x(0) = 0 = x(\pi_p), \end{cases} \quad (13.2)$$

where λ is the eigenvalue parameter. Here π_p is the same as in the Section 1 and its value is defined by the formula

$$\pi_p = 2 \int_0^1 \frac{ds}{\sqrt[p]{1-s^p}}. \quad (13.3)$$

Eigenvalue problem (13.2) is a special case of the general Sturm–Liouville problem for half-linear equations treated in Section 11, but its simple structure enables to determine completely the eigenvalues and eigenfunctions. The situation is essentially the same as

in the linear case where the eigenvalues are $\lambda_n = n^2$ with the associated eigenfunctions $x_n(t) = \sin nt$.

THEOREM 13.1. *The eigenvalues of (13.2) are $\lambda_n = (p - 1)n^p$, $n \in \mathbb{N}$, and the corresponding eigenfunctions are (up to a nonzero multiplicative factor) $x_n(t) = \sin_p(nt)$, where the half-linear sine function \sin_p is defined in Section 1.*

PROOF. The proof of this statement follows immediately from the homogeneity of the solution space of half-linear equations and from the unique solvability of the initial value problem for these equations. The function $x_1(t) = \sin_p t$ is a solution of (13.2) with $\lambda = (p - 1)$ and satisfies $x(0) = 0 = x(\pi_p)$ (by the definition of this function in Section 1), and $x_n(t) = \sin_p(nt)$ is a solution of (13.2) with $\lambda_n = (p - 1)n^p$. \square

13.2. Variational characterization of eigenvalues

In the linear case, the Courant–Fischer minimax principle provides a variational characterization of eigenvalues of the classical Sturm–Liouville eigenvalue problem. This characterization is based on the orthogonality of the eigenfunctions corresponding to different eigenvalues. In the half-linear case the meaning of orthogonality is lost, but eigenvalues can be described using the Lusternik–Schnirelman procedure, for general facts concerning this approach we refer to [103]. The specification of this method to (13.2) presented here can be found in [80].

Let us introduce the functionals over $\mathcal{X} := W_0^{1,p}(0, \pi_p)$, endowed with the norm $\|x\| = (\int_0^{\pi_p} |x'|^p dt)^{\frac{1}{p}}$,

$$A(x) = \frac{1}{p} \int_0^{\pi_p} |x'|^p dt, \quad B(x) = \frac{1}{p} \int_0^{\pi_p} |x|^p dt.$$

Eigenfunctions and eigenvalues of (13.2) are equivalent to critical points and critical values of the functional

$$E(x) = \frac{A(x)}{B(x)}.$$

We also introduce the notation

$$\mathcal{S} = \{x \in \mathcal{X} : B(x) = 1\},$$

(hence $E(x) = A(x)$, $E'(x) = A'(x) - A(x)B'(x)$ for $x \in \mathcal{S}$, where A' , B' , E' are differentials of the functionals A , B , E , respectively). After some computation one can verify that $E|_{\mathcal{S}}$ satisfies the so-called *Palais–Smale condition*: if $\{x_k\} \in \mathcal{S}$ is a sequence such that $E(x_k)$ is convergent and $E'(x_k) \rightarrow 0$ in \mathcal{X}^* (the dual space of \mathcal{X}), then $\{x_k\}$ contains a convergent subsequence (in the norm of \mathcal{X}).

Let us recall also the definition of the Krasnoselskii genus of a symmetric set $\mathcal{A} \subset \mathcal{X}$.
Let

$$\mathcal{F} := \{\mathcal{A} \subset \mathcal{X}: \mathcal{A} \text{ is closed and } \mathcal{A} = -\mathcal{A}\}$$

and let

$$\mathcal{M} = \{m \in \mathbb{N}: \exists h \in C(\mathcal{A}; \mathbb{R}^m \setminus \{0\}) \text{ such that } h(-x) = -h(x)\}.$$

Then the Krasnoselskii genus of \mathcal{A} is defined by

$$\gamma(\mathcal{A}) := \begin{cases} \inf \mathcal{M}, & \text{if } \mathcal{M} \neq \emptyset, \\ \infty, & \text{if } \mathcal{M} = \emptyset. \end{cases}$$

Using the above given concepts we can now present the formulas for variational characterization of *all* eigenvalues of (13.2).

THEOREM 13.2. *Let*

$$\begin{aligned} \mathcal{F}_k &:= \{\mathcal{A} \in \mathcal{F}: 0 \notin \mathcal{A}, \gamma(\mathcal{A}) \geq k\}, \\ \tilde{\mathcal{F}}_k &:= \{\mathcal{A} \in \mathcal{F}_k: \mathcal{A} \subset \mathcal{S}, \mathcal{A} \text{ is compact}\} \end{aligned}$$

and let

$$\beta_k = \min_{\mathcal{A} \in \tilde{\mathcal{F}}_k} \max_{x \in \mathcal{A}} E(x). \tag{13.4}$$

Then $\beta_n = \lambda_n = (p - 1)n^p$ for $n \in \mathbb{N}$.

PROOF. We present only a brief outline of the proof of this statement. First it is proved that the n th eigenvalue λ_n satisfies $\lambda_n \leq \beta_n$. Then, via the construction of a suitable set $\mathcal{A} \in \tilde{\mathcal{F}}$, it is shown that $\lambda_n \geq \beta_n$. We refer to [80] for details. \square

13.3. Nonresonance problem

In this subsection we consider the nonhomogeneous problem

$$\begin{cases} (\Phi(x'))' + \lambda\Phi(x) = f(t), \\ x(0) = 0 = x(\pi_p). \end{cases} \tag{13.5}$$

Let

$$\mathcal{J}_f^\lambda(x) := \frac{1}{p} \int_0^{\pi_p} |x'(t)|^p dt - \frac{\lambda}{p} \int_0^{\pi_p} |x(t)|^p dt - \int_0^{\pi_p} f(t)x(t) dt$$

and suppose that λ is not an eigenvalue, i.e., $\lambda \neq \lambda_k$. For simplicity we deal with $f \in C[0, \pi_p]$ and solution of (13.5) is understood in the classical sense, i.e., it is a function x such that $\Phi(x') \in C^1[0, \pi_p]$ and equation and boundary conditions in (13.5) are satisfied. Similarly as in the previous subsection, the critical points of \mathcal{J}_f^λ are in one to one correspondence with solutions of (13.5).

Due to the variational characterization of the least eigenvalue

$$\lambda_1 = \min \frac{\int_0^{\pi_p} |x'(t)|^p dt}{\int_0^{\pi_p} |x(t)|^p dt}, \tag{13.6}$$

where the minimum is taken over all nonzero elements of $W_0^{1,p}(0, \pi_p)$ and due to the monotonicity of the operators

$$A', B' : W_0^{1,p}(0, \pi_p) \rightarrow (W_0^{1,p}(0, \pi_p))^*$$

defined by (note that these operators are differentials of operators A, B defined in the previous subsection)

$$\langle A'u, v \rangle = \int_0^{\pi_p} \Phi(u'(t))v'(t) dt, \quad \langle B'u, v \rangle = \int_0^{\pi_p} \Phi(u(t))v(t) dt$$

(here $\langle \cdot, \cdot \rangle$ is the duality pairing between $(W_0^{1,p}(0, \pi_p))^*$ and $W_0^{1,p}(0, \pi_p)$) it is easy to prove that for $\lambda \leq 0$ the energy functional \mathcal{J}_f^λ has a unique minimizer in $W_0^{1,p}(0, \pi_p)$ for arbitrary $f \in (W_0^{1,p}(0, \pi_p))^*$. In particular, it follows from here that given arbitrary $f \in C[0, \pi_p]$, the problem (13.5) has a unique solution. So, from this point of view, the situation is the same for $p = 2$ (linear case) and $p \neq 2$.

The case $\lambda > 0$ is different. It is well known that for $p = 2$ and $\lambda \neq \lambda_k, k = 1, 2, \dots$, for any $f \in C[0, \pi_p]$ the problem (13.5) has a unique solution, which follows e.g. from the Fredholm alternative. Let us consider now $p \neq 2$ and $0 < \lambda < \lambda_1$. Due to the variational characterization of λ_1 given by (13.6), the energy functional is still coercive but the monotone operators A', B' “compete” because of the positivity of λ . While in the linear case $p = 2$ this fact does not affect the uniqueness, for $p \neq 2$ the following interesting phenomenon is observed.

THEOREM 13.3. *There exists functions $f \in C[0, \pi_p]$ such that \mathcal{J}_f^λ has at least two critical points. One of them corresponds to the global minimizer of \mathcal{J}_f^λ on $W_0^{1,p}(0, \pi_p)$ (which does exist due to $\lambda < \lambda_1$) and the other is a critical point of saddle type.*

Examples which illustrate these facts were given in [101] for $1 < p < 2$ and in [52] for $p > 2$. The results were generalized for general $\lambda > 0$ in [82].

13.4. Fredholm alternative for the scalar p -Laplacian

This is perhaps the most interesting part of the qualitative theory of half-linear differential equations, since one meets there phenomena which are completely different comparing with the classical Fredholm alternative for the linear boundary value problem

$$u'' + m^2u = h(t), \quad u(0) = 0 = u(\pi),$$

which has a solution if and only if

$$\int_0^\pi h(t) \sin mt \, dt = 0. \tag{13.7}$$

In this subsection we discuss the extension of the Fredholm alternative to (13.5). We suppose that $\lambda = \lambda_k$ for some $k \in \mathbb{N}$, so the problem (13.2) possesses a nontrivial solution $x(t) = \sin_p(kt)$. The half-linear version of (13.7) when $\lambda = \lambda_1$ and $m = 1$ is

$$\int_0^{\pi_p} f(t) \sin_p t \, dt = 0. \tag{13.8}$$

The next theorem show that (13.8) is sufficient but generally not necessary for solvability of (13.5) with $\lambda = \lambda_1$. The statements of this section are taken from [49]. We present them without proofs since these proofs are technically rather complicated.

THEOREM 13.4. *Let us assume that $f \in C^1[0, \pi_p]$, $f \not\equiv 0$ and (13.8) is satisfied. Then (13.5) with $\lambda = \lambda_1$ has at least one solution. Moreover, if $p \neq 2$, then the set of possible solutions is bounded in $C^1[0, \pi_p]$.*

Observe that this result really reveals a striking difference between the cases $p \neq 2$ and $p = 2$, since in the latter case the solution set is an unbounded continuum. It would be natural to expect the number of solutions under (13.8) be *generically finite* if $p \neq 2$.

Note also that in the proof of Theorem 13.4 it appears that the degree of the fixed point of a certain associated operator in a large ball of $C^1[0, \pi_p]$ becomes $+1$ if $p > 2$ while equals -1 if $p < 2$.

The eigenvalue problem (13.5) with $\lambda = \lambda_1$ and $f \equiv 0$ is closely related to the L^p -Poincaré inequality

$$\int_0^{\pi_p} |x'(t)|^p \, dt \geq C \int_0^{\pi_p} |x(t)|^p \, dt, \quad \text{for all } x \in W_0^{1,p}(0, \pi_p). \tag{13.9}$$

The constant $C = \lambda_1$ is precisely the largest $C > 0$ for which (13.9) holds. Then $\int_0^{\pi_p} |x'|^p - \lambda_1 \int_0^{\pi_p} |x|^p \geq 0$ for all $x \in W_0^{1,p}(0, \pi_p)$ while it minimizes and equals 0 exactly on the ray generated by the first eigenfunction $\sin_p t$. Now we consider the following question:

What is the sensitivity of this optimal Poincaré’s inequality under a linear perturbation? We consider then the functional

$$\mathcal{J}_f^{\lambda_1}(x) = \frac{1}{p} \int_0^{\pi_p} |x'|^p dt - \frac{\lambda_1}{p} \int_0^{\pi_p} |x|^p dt + \int_0^{\pi_p} f x dt$$

and ask whether $\mathcal{J}_f^{\lambda_1}$ is *bounded from below*. It is easy to see that a necessary condition for this is that f satisfies the orthogonality condition (13.8) for otherwise E_1 is unbounded below along the ray generated by the first eigenfunction. If $p = 2$, an L^2 -orthogonal expansion into the Fourier series yields that this condition is also sufficient for the boundedness from below. However, this approach seems to be of no use when $p \neq 2$. Under the additional assumption $f \in C^1[0, \pi_p]$, the answer answering the sufficiency is provided by the following result. Note that some of its conclusions are already implied by the previous theorem.

THEOREM 13.5. *Assume that $f \in C^1[0, \pi_p]$, $f \not\equiv 0$, and (13.8) holds.*

- (i) *For $1 < p < 2$ the functional $\mathcal{J}_f^{\lambda_1}$ is bounded from below. The set of its critical points is nonempty and bounded.*
- (ii) *For $p > 2$ the functional $\mathcal{J}_f^{\lambda_1}$ is bounded from below and has a global minimizer. The set of its critical points is bounded, however $\mathcal{J}_f^{\lambda_1}$ does not satisfy the Palais–Smale condition at the level 0.*

It is interesting to see that changing p from $p > 2$ to $p < 2$ shifts the structure of this functional $\mathcal{J}_f^{\lambda_1}$ from global minima to a saddle point geometry for its level sets. If $p = 2$ the functional is convex with a whole ray of minimizers. This result seems to be open and interesting issue concerning the geometry of L^p spaces where the absence of a good orthogonality notion makes the structure of Poincaré-type inequality fairly subtle.

On the other hand, the statement (ii) in the last theorem sets a word of warning in the use of min-max schemes based on the Palais–Smale condition in resonant problems involving the p -Laplacian. Here a very natural example arises of an equation with a priori estimates for the solutions for which the Palais–Smale condition in the associated functional fails to hold. We refer to the paper [49] for details.

Our next result states in particular another interesting difference with the linear case $p = 2$. If $p \neq 2$, then the set of functions f for which (13.5) with $\lambda = \lambda_1$ is solvable has *nonempty interior* in $L^\infty(0, \pi_p)$.

THEOREM 13.6. *Let $p \neq 2$. Then there exists an open cone $\mathcal{C} \subset L^\infty(0, \pi_p)$ such that for all $f \in \mathcal{C}$ problem (13.5) with $\lambda = \lambda_1$ has at least two solutions. Moreover*

$$\int_0^{\pi_p} f(t) \sin_p t dt \neq 0 \tag{13.10}$$

for all $f \in \mathcal{C}$.

A by-product of the proof of this theorem is the following general fact. For any $f \in L^\infty(0, \pi_p)$ such that (13.10) holds, one has that the set of all possible solutions of (13.5) is bounded and the degree of the associated fixed point operator equals 0. Combining this and Theorem 13.4 yields in particular that for any $f \neq 0$ of the class C^1 and $p \neq 2$, there are *a priori estimates* for the solution set.

The proof of the results presented in this subsection are based on the analysis of the initial value problem

$$(\Phi(x'))' + (p - 1)\Phi(x) = f(t), \quad x(0) = 0, \quad x'(0) = \alpha,$$

with $f \in L^\infty_{loc}[0, \infty)$. Here, x is a globally defined solution of this problem and for α sufficiently large (positive or negative) a first zero $t_1^\alpha > 0$ exists. Moreover, $t_1^\alpha \rightarrow \pi_p$ as $|\alpha| \rightarrow \infty$. The key matter is a detailed analysis of the relative location of t_1^α with respect to π_p for large $|\alpha|$. Of course, one has a solution of (13.5) with $\lambda = \lambda_1$ whenever t_1^α hits exactly π_p . In particular, in the asymptotic expansion of the dependence of t_1^α on α yields that under assumptions of Theorem 13.4, one has

$$t_1^\alpha < \pi_p \quad \text{if } p < 2 \quad \text{and} \quad t_1^\alpha > \pi_p, \quad \text{if } p > 2,$$

whenever $|\alpha|$ is sufficiently large.

13.5. Homotopic deformation along p and Leray–Schauder degree

The Leray–Schauder degree of a mapping associated with the investigated BVP is one of the most frequently used methods when dealing with this problem. In this subsection we briefly present the main ideas of [52] which deals with solvability of (13.1). First consider the associated problem

$$(\Phi_p(x'))' = f(t), \quad x(0) = 0 = x(\pi_p), \tag{13.11}$$

(note that $\Phi_p = \Phi$) and the energy functional corresponding to this problem

$$\Psi_p(x) = \frac{1}{p} \int_0^{\pi_p} |x'(t)|^p dt - \int_0^{\pi_p} f(t)x(t) dt. \tag{13.12}$$

Here we use the index p by Φ and Ψ to stress their dependence on the power p . The functional Ψ_p is coercive, continuous and convex over $W_0^{1,p}(0, \pi_p)$ and hence it possesses the unique global minimum which is the critical point and hence a solution of (13.11). This means that we have correctly defined mapping $G_p : L^q(0, \pi_p) \rightarrow C^1[0, \pi_p]$ which assigns to the right-hand side f of (13.11) the solution x of this problem. This mapping is completely continuous. Moreover, if p_n is a real sequence such that $p_n \rightarrow p$ and $f_n \in L^q(0, \pi_{p_n})$ is such that $f_n \rightharpoonup f \in L^q(0, \pi_p)$ (\rightharpoonup denotes the weak convergence), then $\lim_{n \rightarrow \infty} G_{p_n}(f_n) = G_p(f)$ as it is shown in [52].

Now, for fixed $p > 1$, we define $T_p : C[0, \pi_p] \rightarrow C[0, \pi_p]$ by $T_p(x) = x - G_p(\lambda \Phi_p(x))$ with $\lambda \in \mathbb{R}$. Obviously, the equation $T_p(x) = 0$ has a nontrivial solution if and only if $\lambda = \lambda_n(p) = (p - 1)n^p$ and this solution is $x_n(t) = \alpha \sin_p(nt)$, $\alpha \in \mathbb{R}$, $\alpha \neq 0$.

The following statement concerns a homotopic deformation along the power p of the Leray–Schauder degree of the mapping T_p . Note that the classical result of the linear theory is that the Leray–Schauder degree of T_2 with respect to the ball

$$B(0, r) := \left\{ u \in C[0, \pi_p]: \|u\|_C = \max_{t \in [0, \pi_p]} |u(t)| \leq r \right\}$$

is

$$d(T_2, B(0, r), 0) = (-1)^n, \tag{13.13}$$

where n is the number of the eigenvalues of (13.2) with $p = 2$ which are less than λ .

THEOREM 13.7. *Let $p > 1$ be arbitrary, $\lambda \neq \lambda_n(p) = (p - 1)n^p$, $n \in \mathbb{N}$. Then for every $r > 0$, the Leray–Schauder degree $d(T_p, B(r, 0), 0)$ is well defined and satisfies*

$$d(T_p, B(r, 0), 0) = (-1)^n, \tag{13.14}$$

where n is the number of eigenvalues of (13.2) which are less than λ .

PROOF. Suppose that $p \geq 2$ and $\lambda > \lambda_1 = (p - 1)$, i.e., $\lambda = (p - 1)(n + s)^p$ for some $s \in (0, 1)$ and $n \in \mathbb{N}$. In the remaining cases the idea of the proof is the same. We will show that $d(T_p, B(r, 0), 0) = (-1)^n$ for every $r > 0$.

Let $\Lambda : [p, \infty) \rightarrow \mathbb{R}$ be defined by $\Lambda(\alpha) = [(n + s)\pi_\alpha / \pi_p]^\alpha$, where π_α is given by (13.3) with α instead of p . Obviously, π_α depends continuously on α and hence Λ is continuous. Next, define the mapping

$$T(\alpha, x) = x - G_\alpha(\Lambda(\alpha)\Phi_\alpha(x)).$$

The mapping $\tilde{G}(\alpha, x) := G_\alpha(\Lambda(\alpha)\Phi_\alpha(x))$ is completely continuous and $T(\alpha, x) \neq 0$ for all $\alpha \in [p, \infty)$ (for details see [52, Theorem 4.1]). Hence, from the invariance of the degree under homotopies and from (13.13) we obtain the required statement. \square

THEOREM 13.8. *Suppose that there exists $n \in \mathbb{N}$ such that the nonlinearity g in (13.1) satisfies*

$$\lambda_n \leq a(t) := \liminf_{|s| \rightarrow \infty} \frac{g(t, s)}{\Phi(s)} \leq \limsup_{|s| \rightarrow \infty} \frac{g(t, s)}{\Phi(s)} =: b(t) \leq \lambda_{n+1}$$

uniformly on $[0, \pi_p]$, the first and the last inequalities being strict on a subset of positive measure in $[0, \pi_p]$. Then the BVP (13.1) has a solution.

PROOF. Let $v \in (\lambda_n, \lambda_{n+1})$. According to the previous theorem, it suffices to construct a homotopic bridge connecting (13.1) with the problem

$$(\Phi(x'))' + v\Phi(x) = 0, \quad x(0) = 0 = x(\pi_p).$$

The degree of the mapping associated with this problem has been computed in the previous theorem. This homotopy is defined as follows

$$H(\tau, x) = G_p(\tau v\Phi(x) + (1 - \tau)g(t, x(t))).$$

Using the standard method it can be proved that there exists $r > 0$ such that $x - H(\tau, x) \neq 0$ for $x \in \partial B(r, 0)$ for every $\tau \in [0, 1]$ if $r > 0$ is sufficiently large. This proof goes by contradiction. Supposing that there exists $x_n \in C[0, \pi_p]$ and with $\|x_n\|_C \rightarrow \infty$ and $\tau_n \in [0, 1]$ such that $x_n = H(\tau_n, x_n)$, functions v and c are constructed (using essentially the same construction as in the linear case) in such a way that the half-linear equation

$$(\Phi(v'))' + c(t)\Phi(v) = 0, \quad v(0) = 0 = v(\pi_p)$$

with $\lambda_n \leq c(t) \leq \lambda_{n+1}$ has a nontrivial solution. Since each of the previous inequalities is strict on the set of the positive measure, we have a contradiction with the Sturmian comparison theorem. □

13.6. Resonance problem

In the previous subsection, the nonlinearity was “situated” between two consecutive eigenvalues, i.e., it did not “interact” with the spectrum of the half-linear part. This situation is usually regarded as a *nonuniform nonresonance*. Now we deal with the situation when the nonlinearity is of the form $\lambda_n\Phi(x) + g(x)$ with a bounded function g , so the nonlinearity (perhaps, a better terminology would be “nonhalf-linearity”) is “around” an eigenvalue of the half-linear part. This situation is referred to as the *resonant case*. The paper of Landesman and Lazer [145] published in 1970 is the pioneering work along this line in the linear case. Since that time, the conditions ensuring solvability of BVPs in resonance (the so-called Landesman–Lazer conditions) have been extended in many directions. The next theorem, taken from [80], establishes the Landesman–Lazer solvability conditions for the half-linear BVP

$$(\Phi(x'))' + \lambda_n\Phi(x) + g(x) = h(t), \quad x(0) = 0 = x(\pi_p). \tag{13.15}$$

It is supposed that there exist finite limits $\lim_{x \rightarrow \pm\infty} g(x) = g(\pm\infty)$. By φ_n we denote the eigenfunction corresponding to the n th eigenvalue, i.e., $\lambda_n = (p - 1)n^p$, $\varphi_n(t) = \alpha_n \sin_p(nt)$, where $\alpha_n > 0$ is such that $\|\varphi_n\|_{L^p} = 1$.

THEOREM 13.9. *The boundary value problem (13.15) has a solution provided one of the following two conditions is satisfied*

$$\begin{aligned} & g(\infty) \int_0^{\pi_p} \varphi_n^+(t) dt + g(-\infty) \int_0^{\pi_p} \varphi_n^-(t) dt \\ & > \int_0^{\pi_p} \varphi_n(t) h(t) dt \\ & > g(\infty) \int_0^{\pi_p} \varphi_n^-(t) dt + g(-\infty) \int_0^{\pi_p} \varphi_n^+(t) dt, \end{aligned}$$

or

$$\begin{aligned} & g(\infty) \int_0^{\pi_p} \varphi_n^+(t) dt + g(-\infty) \int_0^{\pi_p} \varphi_n^-(t) dt \\ & < \int_0^{\pi_p} \varphi_n(t) h(t) dt \\ & < g(\infty) \int_0^{\pi_p} \varphi_n^-(t) dt + g(-\infty) \int_0^{\pi_p} \varphi_n^+(t) dt, \end{aligned}$$

where $\varphi_n^+ = \max\{0, \varphi_n\}$, $\varphi_n^- = \min\{0, \varphi_n\}$.

We skip the proof of this statement because of its technical complexity. This proof is based on a variant of the saddle point theorem and relies on the variational characterization of eigenvalues of (13.2).

14. Quasilinear and related differential equations

In this section we change the notation which we used throughout the whole treatment. Till now, q was the conjugate number of p , i.e., $q = \frac{p}{p-1}$. In this section q is any real number satisfying $q > 1$ and the conjugate number of p will be denoted by p^* . The main part of this section will be devoted to the equation

$$(r(t)\Phi_p(x'))' + c(t)\Phi_q(x) = 0, \quad \Phi_p(s) = |s|^{p-2}s, \quad \Phi_q(s) := |s|^{q-2}s, \quad (14.1)$$

we will briefly treat also some more general equations. The functions r, c satisfy the same assumptions as in (0.1). Note that using the substitution $r\Phi_p(x') =: u$, Equation (14.1) can be written as the first order system of the form

$$x' = a_1(t)|u|^{\lambda_1} \operatorname{sgn} u, \quad u' = a_2(t)|x|^{\lambda_2} \operatorname{sgn} x \quad (14.2)$$

with suitable functions a_1, a_2 and real constants λ_1, λ_2 . The last system has been investigated in several papers of Mirzov and the results are summarized in his book [178]. As a sample of papers dealing with (14.1) and related equations we refer to [16,34,132,144,205] and the references given therein.

14.1. Equation (14.1) with constant coefficients

The results of this subsection are taken from [78]. First we focus our attention to the initial value problem

$$(\Phi_p(x'))' + \lambda \Phi_q(x) = 0, \quad x(0) = a, \quad x'(0) = b. \tag{14.3}$$

We will modify the method used in the definition of the half-linear sine function \sin_p and of other half-linear trigonometric functions.

THEOREM 14.1. *For any $\lambda \geq 0$, the initial value problem (14.3) has a unique solution defined on the whole real line \mathbb{R} .*

PROOF. The crucial fact used in the proof is that

$$\frac{|x'(t)|^p}{p^*} + \lambda \frac{|x(t)|^q}{q} = \frac{|b|^p}{p^*} + \lambda \frac{|a|^q}{q} \tag{14.4}$$

as can be verified by differentiation. Clearly, if $a = 0 = b$, the last identity implies that the trivial solution is the unique solution. If $a = 0$ or $b = 0$, supposing that there are two different solutions x_1, x_2 satisfying the same initial condition, we find that the absolute value of their difference $z = |x_1 - x_2|$ satisfies a Gronwall-type inequality and hence $z \equiv 0$. This idea, slightly modified, applies also to the case when both $a \neq 0$ and $b \neq 0$. \square

The remaining part of this subsection will be devoted to the initial value problem

$$(\Phi_p(x'))' + \lambda \Phi_q(x) = 0, \quad x(0) = 0, \quad x'(0) = \alpha > 0. \tag{14.5}$$

Denote by t_α the first positive zero of the derivative x' , i.e., $x(t) > 0, x'(t) > 0$ for $t \in (0, t_\alpha)$. Further denote by $R := x(t_\alpha)$. Then using the same idea as above we have the identity

$$\frac{(x'(t))^p}{p^*} + \lambda \frac{x^q(t)}{q} = \lambda \frac{R^q}{q}. \tag{14.6}$$

Solving this equality for x' and integrating, we find

$$\left(\frac{q}{\lambda p^*}\right)^{\frac{1}{p}} \int_0^t \frac{x'(s) ds}{(R^q - x^q(s))^{\frac{1}{p}}} = t, \tag{14.7}$$

which after a change of variables can be written as

$$t = \left(\frac{q}{\lambda p^*}\right)^{\frac{1}{p}} \frac{1}{R^{\frac{q-p}{p}}} \int_0^{\frac{x}{R}} \frac{ds}{(1 - s^q)^{\frac{1}{p}}}. \tag{14.8}$$

For $t \in [0, \frac{q}{2}]$, let us set

$$\arcsin_{pq} t := \frac{q}{2} \int_0^{\frac{2t}{q}} \frac{ds}{(1 - s^q)^{\frac{1}{p}}}, \tag{14.9}$$

and note that this integral converges for $t \in [0, \frac{q}{2}]$. Substituting $t = \tau^{\frac{1}{q}}$ in (14.9), we obtain

$$\arcsin_{pq} t = \frac{1}{2} \tilde{B}\left(\frac{1}{q}, \frac{1}{p^*}, \left(\frac{2t}{q}\right)^q\right), \tag{14.10}$$

where

$$\tilde{B}\left(\frac{1}{q}, \frac{1}{p^*}, y\right) = \int_0^y \tau^{\frac{1}{q}-1} (1 - \tau)^{-\frac{1}{p}} d\tau$$

denotes the incomplete beta function. Next, substituting $t = \frac{q}{2}$ in (14.10), we define

$$\pi_{pq} := 2 \arcsin_{pq} \left(\frac{q}{2}\right) = B\left(\frac{1}{q}, \frac{1}{p^*}\right),$$

where B denoted the classical Euler beta function. When $p = q$, the definition of \arcsin_{pq} and of π_{pq} coincides with the definition of \arcsin_p and π_p in Section 1.1.

The function $\arcsin_{pq} : [0, \frac{q}{2}] \rightarrow [0, \frac{\pi_{pq}}{2}]$, so we can define first $\sin_{pq} : [0, \frac{\pi_{pq}}{2}] \rightarrow [0, \frac{q}{2}]$ as the inverse function of \arcsin_{pq} and then to define this function for $t \in \mathbb{R}$ in the obvious way: $\sin_{pq} t = \sin_{pq}(\pi_{pq} - t)$ for $t \in [\frac{\pi_{pq}}{2}, \pi_{pq}]$ and then extend this function over \mathbb{R} as odd and $2\pi_{pq}$ periodic function. It is a simple matter to verify that \sin_{pq} is the unique (global) solution of the initial value problem

$$(\Phi_p(x'))' + \frac{2^q}{p^* q^{q-1}} \Phi_q(x) = 0, \quad x(0) = 0, \quad x'(0) = 1. \tag{14.11}$$

Similarly as in case $p = q$ we denote $\cos_{pq} t = \frac{d}{dt} \sin_{pq} t$. Then from (14.4) and (14.11) we have

$$|\cos_{pq} t|^p + \left(\frac{2}{q}\right)^q |\sin_{pq} t|^q \equiv 1. \tag{14.12}$$

From (14.8) and (14.9) we find that

$$t = \frac{2}{(\lambda p^*)^{\frac{1}{p}} q^{\frac{1}{p^*}}} R^{\frac{p-q}{p}} \arcsin_{pq} \left(\frac{qx}{2R}\right), \tag{14.13}$$

and hence

$$x(t) = \frac{2R}{q} \sin_{pq} \left(\frac{(\lambda p^*)^{\frac{1}{p}} q^{\frac{1}{p^*}}}{2} R^{\frac{q-p}{p}} t\right), \tag{14.14}$$

for all $t \in \mathbb{R}$.

From (14.6) we can express R in term of α to obtain

$$R^{\frac{q-p}{p}} = \left(\frac{q}{\lambda p^*} \right)^{\frac{q-p}{pq}} \alpha^{\frac{q-p}{q}}.$$

Substituting this expression into (14.14), and setting

$$A_{pq}(\alpha, \lambda) := \frac{(\lambda p^*)^{\frac{1}{q}} q^{\frac{1}{q^*}}}{2} \alpha^{\frac{q-p}{q}}, \quad q^* = \frac{q}{q-1},$$

we find that the solution of (14.5) is

$$x(t) = \frac{\alpha}{A_{pq}(|\alpha|, \lambda)} \sin_{pq}(A_{pq}(|\alpha|, \lambda)t), \tag{14.15}$$

and this solution is $\tau(\alpha)$ -periodic function with

$$\tau(\alpha) = \frac{2\pi pq}{A_{pq}(\alpha, \lambda)} = 4t_\alpha.$$

THEOREM 14.2. *For any given $\alpha \neq 0$, the set of eigenvalues of the problem*

$$(\Phi_p(x'))' + \lambda \Phi_q(x) = 0, \quad x(0) = 0 = x(T) \tag{14.16}$$

is given by

$$\lambda(\alpha) = \left(\frac{2n\pi pq}{T} \right)^q \frac{|\alpha|^{p-q}}{p^* q^{q-1}}, \quad n \in \mathbb{N}, \tag{14.17}$$

with the corresponding eigenfunctions

$$x_{n,\alpha}(t) = \frac{\alpha T}{n\pi pq} \sin_{pq} \left(\frac{n\pi pq}{T} t \right). \tag{14.18}$$

PROOF. For a given $\alpha \in \mathbb{R}$, by imposing that x in (14.15) satisfies the boundary conditions in (14.16), we obtain that λ is an eigenvalue of this problem if and only if

$$\frac{1}{2} (p^*)^{\frac{1}{q}} q^{\frac{1}{q^*}} \lambda^{\frac{1}{q}} |\alpha|^{\frac{q-p}{q}} T = n\pi pq, \quad n \in \mathbb{N}, \tag{14.19}$$

and hence (14.17) follows. The expression for eigenfunctions follows then directly from (14.15). □

14.2. Emden–Fowler type equation

In this subsection we recall very briefly some results concerning asymptotic behavior of the quasilinear equation (14.1) and of the associated system (14.2). As we have mentioned before, the solution space (14.1) and of (14.2) is no longer even homogeneous, hence the investigation of these equations and systems is more complicated than in case of half-linear equations (0.1). Equation (14.1) and system (14.2) are sometimes called *Emden–Fowler type equation (system)* since if $p = 2$ in (14.1), this equation reduces to Emden–Fowler equation (1.3) mentioned in Section 1.1.

Recall that a solution x of (14.1) is called the *singular solution of the first kind* if x becomes eventually trivial, i.e., there exists $T \in \mathbb{R}$ such that $x \neq 0$ for $t < T$ and $x(t) = 0$ for $t \geq T$, and a solution x is *singular solution of the second kind* if there exists a finite time T such $\lim_{t \rightarrow T-} |x(t)| = \infty$. The set of singular solution of the first and second kind we will denote by \mathbb{S}_1 and \mathbb{S}_2 , respectively. A solution which is not singular is called *proper*. Recall also the classification of nonoscillatory solutions of (0.1) which can be extended under the assumption that $c(t) \neq 0$ for large t also to (14.1)

$$\begin{aligned} \mathbb{M}^+ &= \{x \text{ solution of (14.1): } \exists t_x \geq 0: x(t)x'(t) > 0 \text{ for } t > t_x\}, \\ \mathbb{M}^- &= \{x \text{ solution of (14.1): } \exists t_x \geq 0: x(t)x'(t) < 0 \text{ for } t > t_x\}. \end{aligned}$$

Results of [43,44,178] imply the following statement.

THEOREM 14.3. *Suppose that $r(t) > 0$, $c(t) < 0$ for large t .*

- (i) *If $p = q$, i.e., (14.1) reduces to (0.1), then $\mathbb{S}_1 = \emptyset$, $\mathbb{S}_2 = \emptyset$, $\mathbb{M}^- \neq \emptyset$ and $\mathbb{M}^+ \neq \emptyset$.*
- (ii) *If $p < q$, then $\mathbb{S}_1 = \emptyset$, $\mathbb{S}_2 \neq \emptyset$, $\mathbb{M}^- \neq \emptyset$.*
- (iii) *If $p > q$, then $\mathbb{S}_1 \neq \emptyset$, $\mathbb{S}_2 = \emptyset$ and $\mathbb{M}^+ \neq \emptyset$.*

In Section 6 we have seen that certain integrals of functions r, c play an important role in the asymptotic classification of nonoscillatory solutions of (0.1). As an illustration of the extension of these results to (14.1) we give two statements. The first one is proved in [33] using the Schauder–Tychonov fixed point theorem, while the second one follows from the results of Kvinikadze [143], see also [33].

THEOREM 14.4. *Suppose that $r(t) > 0$, $c(t) < 0$ for large t , $\int^\infty r^{1-p^*}(t) dt < \infty$ and*

$$\int^\infty \Phi_q \left(\int_t^\infty r^{1-p^*}(s) ds \right) dt < \infty,$$

where $\Phi_q(s) = |s|^{q-1} \operatorname{sgn} s$. Then there exists at least one solution x of (14.1) in the class \mathbb{M}^- such that $\lim_{t \rightarrow \infty} x(t) = 0$ and

$$\lim_{t \rightarrow \infty} \frac{x(t)}{\int_t^\infty r^{1-p^*}(s) ds} = \ell_x, \quad 0 < \ell_x < \infty.$$

THEOREM 14.5. *Suppose that $r(t) > 0$, $c(t) < 0$ for large t , $p < q$ and*

$$\int^{\infty} r^{1-p^*}(t) \Phi_{p^*} \left(\int^t |c(s)| \, ds \right) dt < \infty$$

or

$$\int^{\infty} |c(t)| \Phi_q \left(\int^t r^{1-p^*}(s) \, ds \right) dt < \infty.$$

Then \mathbb{M}^+ contains a one parametric family of the so-called strongly increasing solutions, i.e., solutions satisfying

$$\lim_{t \rightarrow \infty} x(t) = \infty, \quad \lim_{t \rightarrow \infty} r(t) \Phi_p(x'(t)) = \infty \tag{14.20}$$

and a one parametric family of the so-called positive weakly increasing solutions, i.e., positive solutions where both limits in (14.20) exists finitely.

Another results concerning asymptotic properties of nonoscillatory solutions of (14.1) and of more general equations of this type can be found in [34,35,138,141,180,205,210, 218].

14.3. More about quasilinear equations

The results of this subsection can be found in [120] and concern the equation

$$(\Phi(x'))' + f(t, x) = 0 \tag{14.21}$$

under the assumptions that the function f satisfies $\text{sgn } f(t, x) = \text{sgn } x$ for $t \in [t_0, \infty)$.

THEOREM 14.6. *All proper solutions of (14.21) are oscillatory if one of the following three conditions is satisfied:*

(i) for all $\delta > 0$

$$\int^{\infty} \inf_{\delta \leq |y|} |f(t, y)| \, dt = \infty,$$

(ii) for some $0 < \lambda < p - 1$ and all $\delta > 0$

$$\int^{\infty} t^\lambda \inf_{\delta \leq |y|} \frac{f(t, y)}{|y|^{p-1}} \, dt = \infty,$$

(iii) for all δ, δ' with $\delta' > \delta > 0$

$$\int^{\infty} \inf_{\delta \leq |y| \leq \delta'} |f(t, y)| \, dt = \infty,$$

and there exists a positive continuous function φ satisfying $\int^\infty \varphi(y) dy = \infty$, such that $|f(t, y)| \geq \varphi(|y|)$ for large t and large $|y|$.

PROOF. To illustrate ideas used in the proof, we prove the part (ii), the proof of the remaining two statements is analogical. Suppose, by contradiction, that (14.21) has a proper solution x which is positive for large t (if x is negative, we proceed analogically). Then from (14.21) we have that also $x'(t) > 0$ and we put $w(t) = \frac{\Phi(x')}{\Phi(x)}$ (compare the remark (ii) in Section 9.1). Then w satisfies the Riccati-type equation

$$w' + (p-1)|w|^{p^*} + \frac{f(t, x(t))}{x^{p-1}(t)} = 0, \quad (14.22)$$

recall that p^* denotes the conjugate number of p . Multiplying (14.22) by t^λ and integrating over $[t_0, t]$, t_0 sufficiently large, we have

$$\begin{aligned} t^\lambda w(t) - \lambda \int_{t_0}^t s^{\lambda-1} w(s) ds + (p-1) \int_{t_0}^t s^\lambda (w(s))^{p^*} ds \\ + \int_{t_0}^t s^\lambda \frac{f(s, x(s))}{x^{p-1}(s)} ds \leq c, \end{aligned} \quad (14.23)$$

where $c > 0$ is a real constant.

Suppose first that $\int^\infty s^{\lambda-1} w(s) ds < \infty$. Then it follows from (14.23) that

$$\int_{t_0}^t s^\lambda \frac{f(s, x(s))}{x^{p-1}(s)} ds \leq c + \lambda \int_{t_0}^t s^{\lambda-1} w(s) ds,$$

and taking the limit as $t \rightarrow \infty$, we get

$$\int_{t_0}^\infty s^\lambda \frac{f(s, x(s))}{x^{p-1}(s)} ds < \infty.$$

However, this is impossible since assumptions of our theorem imply that for t_0 sufficiently large

$$\int_{t_0}^\infty s^\lambda \frac{f(s, x(s))}{x^{p-1}(s)} ds \geq \int_{t_0}^\infty s^\lambda \inf_{\delta \leq x} \frac{f(s, x)}{x^{p-1}} ds = \infty, \quad (14.24)$$

where $\delta = x(t_0) > 0$.

Suppose next that

$$\int_{t_0}^\infty s^{\lambda-1} w(s) ds = \infty. \quad (14.25)$$

Then, by (14.23),

$$\int_{t_0}^t s^\lambda \frac{f(s, x(s))}{x^{p-1}(s)} ds \leq c + \lambda \int_{t_0}^t s^{\lambda-1} w(s) ds - (p-1) \int_{t_0}^t s^\lambda |w(s)|^{p^*} ds. \tag{14.26}$$

Note that the second integral in Equation (14.26) is estimated by means of the Hölder inequality as follows

$$\begin{aligned} \int_{t_0}^t s^{\lambda-1} w(s) ds &= \int_{t_0}^t s^{(\lambda-p)/p} s^{\lambda(p-1)/p} w(s) ds \\ &\leq \left(\int_{t_0}^t s^{\lambda-p} ds \right)^{\frac{1}{p}} \left(\int_{t_0}^t s^\lambda w^{p^*}(s) ds \right)^{\frac{1}{p^*}} \\ &\leq \left(\frac{t_0^{\lambda-p+1}}{p-1-\lambda} \right)^{\frac{1}{p}} \left(\int_{t_0}^t s^\lambda w^{p^*}(s) ds \right)^{\frac{1}{p^*}} \\ &= \frac{(t_0^{\lambda-p+1}/(p-1-\lambda))^{\frac{1}{p}}}{\left(\int_{t_0}^t s^\lambda w^{p^*}(s) ds \right)^{\frac{1}{p}}} \int_{t_0}^t s^\lambda w^{p^*}(s) ds. \end{aligned} \tag{14.27}$$

Since (14.25) implies that

$$\int_{t_0}^t s^\lambda w^{p^*}(s) ds \rightarrow \infty, \quad \text{as } t \rightarrow \infty,$$

we see from (14.27) that there exists $t_1 \geq t_0$ such that

$$\int_{t_0}^t s^{\lambda-1} w(s) ds \leq \frac{p-1}{\lambda} \int_{t_0}^t s^\lambda w^{p^*}(s) ds, \quad t \geq t_1.$$

Using this inequality in (14.26) we conclude that

$$\int_{t_0}^\infty s^\lambda \frac{f(s, x(s))}{x^{p-1}(s)} ds \leq c$$

in contradiction to (14.24) which holds also in this case. □

15. Partial differential equations with p -Laplacian

Similarly to the boundary value problems for half-linear ordinary differential equations, also partial differential equations with p -Laplacian are treated in many papers. Recall that the p -Laplacian is the partial differential operator

$$\Delta_p u(x) := \operatorname{div}(\|\nabla u(x)\|^{p-2} \nabla u(x)), \quad x = (x_1, \dots, x_N) \in \mathbb{R}^N, \tag{15.1}$$

where $\operatorname{div} := \sum_{k=1}^N \frac{\partial}{\partial x_k}$ is the usual divergence operator and $\nabla u(x) = (\frac{\partial u}{\partial x_1}, \dots, \frac{\partial u}{\partial x_N})$ is the Hamilton nabla operator.

15.1. Dirichlet BVP with p -Laplacian

In this subsection we deal with the properties of the first eigenvalue and the associated eigenfunction of the Dirichlet boundary value problem

$$\begin{cases} \Delta_p u + \lambda \Phi(u) = 0, & x \in \Omega \subset \mathbb{R}^n, \\ u(x) = 0, & x \in \partial\Omega, \end{cases} \quad (15.2)$$

where Ω is a bounded domain in \mathbb{R}^n .

The solution of problem (15.2) is understood in the weak sense; we say that λ is an *eigenvalue* if there exists a function $u \in W_0^{1,p}(\Omega)$, $u \neq 0$, such that

$$\int_{\Omega} \|\nabla u\|^{p-2} \langle \nabla u, \nabla \eta \rangle dx = \lambda \int_{\Omega} \Phi(u) \eta dx, \quad (15.3)$$

for every $\eta \in W_0^{1,p}(\Omega)$, where $\langle \cdot, \cdot \rangle$ denotes the scalar product in \mathbb{R}^N . The function u is called the *eigenfunction*.

The first eigenvalue $\lambda_1 = \lambda_1(\Omega)$ is obtained as the minimum of the Rayleigh quotient

$$\lambda_1 = \inf_v \frac{\int_{\Omega} \|\nabla v\|^p dx}{\int_{\Omega} |v|^p dx}, \quad (15.4)$$

where the infimum is taken over all $v \in W_0^{1,p}(\Omega)$, $v \neq 0$. If u realizes the infimum in (15.4), so does also $|u|$, this leads immediately to the following statement.

THEOREM 15.1. *The eigenfunction u associated with the first eigenvalue λ_1 does not change its sign in Ω . Moreover, if $u \geq 0$ then actually $u > 0$ in the interior of Ω .*

PROOF. The statement concerning the positivity of u follows from the Harnack inequality [213, p. 724]. \square

In the proof of the main result of this subsection we will need the following inequalities, for the proof see [160].

LEMMA 15.1. *Let $w_1, w_2 \in \mathbb{R}^N$.*

(i) *If $p \geq 2$, then*

$$\|w_2\|^p \geq p \|w_1\|^p \langle w_1, (w_2 - w_1) \rangle + \frac{\|w_2 - w_1\|^p}{2^{p-1} - 1}. \quad (15.5)$$

(ii) If $1 < p < 2$, then

$$\|w_2\|^p \geq p\|w_1\|^p \langle w_1, (w_2 - w_1) \rangle + C(p) \frac{\|w_2 - w_1\|^p}{(\|w_1\| + \|w_2\|)^{2-p}}, \tag{15.6}$$

where $C(p)$ is a positive constant depending only on p .

The main statement of this subsection reads as follows.

THEOREM 15.2. *The first eigenvalue of (15.2) is simple and isolated for any bounded domain $\Omega \subset \mathbb{R}^N$.*

PROOF. Here we follow Lindqvist’s [160] modification of the original proof of Anane [11] where it is supposed that the boundary $\partial\Omega$ is of the Hölder class $C^{2,\alpha}$. This assumption on the boundary of Ω is removed in Lindqvist’s proof by introducing the functions $u + \varepsilon$, $v + \varepsilon$ instead of u , v , respectively (used by Anane).

Suppose that u, v are eigenfunctions of (15.3) with $\lambda = \lambda_1$. Let $\varepsilon > 0$ and denote $v_\varepsilon = v + \varepsilon$, $u_\varepsilon = u + \varepsilon$. Further, let $\eta = u_\varepsilon - v_\varepsilon^p u_\varepsilon^{1-p}$, $\tilde{\eta} = v_\varepsilon - u_\varepsilon^p v_\varepsilon^{1-p}$. Then $\eta, \tilde{\eta} \in W_0^{1,p}(\Omega)$ and

$$\nabla \eta = \left\{ 1 + (p - 1) \left(\frac{v_\varepsilon}{u_\varepsilon} \right)^p \right\} \nabla u - p \left(\frac{v_\varepsilon}{u_\varepsilon} \right)^{p-1} \nabla v.$$

A similar formula we have for $\nabla \tilde{\eta}$. Inserting the test functions η and $\tilde{\eta}$ into (15.3) and adding both equations, we get

$$\begin{aligned} & \lambda_1 \int_{\Omega} \left[\frac{u^{p-1}}{u_\varepsilon^{p-1}} - \frac{v^{p-1}}{v_\varepsilon^{p-1}} \right] (u_\varepsilon^p - v_\varepsilon^p) \, dx \\ &= \int_{\Omega} \left[\left\{ 1 + (p - 1) \left(\frac{v_\varepsilon}{u_\varepsilon} \right)^p \right\} \|\nabla u_\varepsilon\|^p + \left\{ 1 + (p - 1) \left(\frac{u_\varepsilon}{v_\varepsilon} \right)^p \right\} \|\nabla v_\varepsilon\|^p \right] \, dx \\ & \quad - \int_{\Omega} \left[p \left(\frac{v_\varepsilon}{u_\varepsilon} \right)^{p-1} \|\nabla u_\varepsilon\|^{p-2} \langle \nabla u_\varepsilon, \nabla v_\varepsilon \rangle \right. \\ & \quad \left. + p \left(\frac{u_\varepsilon}{v_\varepsilon} \right)^{p-1} \|\nabla v_\varepsilon\|^{p-2} \langle \nabla v_\varepsilon, \nabla u_\varepsilon \rangle \right] \, dx \\ &= \int_{\Omega} (u_\varepsilon^p - v_\varepsilon^p) (\|\nabla \lg u_\varepsilon\|^p - \|\nabla \lg v_\varepsilon\|^p) \, dx \\ & \quad - \int_{\Omega} p v_\varepsilon^p \|\nabla \lg u_\varepsilon\|^{p-2} \langle \nabla \lg u_\varepsilon, (\nabla \lg v_\varepsilon - \nabla \lg u_\varepsilon) \rangle \, dx \\ & \quad - \int_{\Omega} p u_\varepsilon^p \|\nabla \lg v_\varepsilon\|^{p-2} \langle \nabla \lg v_\varepsilon, (\nabla \lg u_\varepsilon - \nabla \lg v_\varepsilon) \rangle \, dx \end{aligned} \tag{15.7}$$

and the last term is nonpositive by the inequality given in Lemma 15.1.

It is obvious that

$$\lim_{\varepsilon \rightarrow 0^+} \int_{\Omega} \left[\frac{u^{p-1}}{u_{\varepsilon}^{p-1}} - \frac{v^{p-1}}{v_{\varepsilon}^{p-1}} \right] (u_{\varepsilon}^p - v_{\varepsilon}^p) \, dx = 0. \tag{15.8}$$

Let us first consider the case $p \geq 2$. According to inequality (15.5) we have

$$\begin{aligned} 0 &\leq \frac{1}{2^{p-1} - 1} \int_{\Omega} \left(\frac{1}{v_{\varepsilon}^p} + \frac{1}{u_{\varepsilon}^p} \right) \|v_{\varepsilon} \nabla u_{\varepsilon} - u_{\varepsilon} \nabla v_{\varepsilon}\|^p \, dx \\ &\leq -\lambda_1 \int_{\Omega} \left[\left(\frac{u}{u_{\varepsilon}} \right)^{p-1} - \left(\frac{v}{v_{\varepsilon}} \right)^{p-1} \right] (u_{\varepsilon}^p - v_{\varepsilon}^p) \, dx \end{aligned}$$

for every $\varepsilon > 0$ (here we have used inequality (15.5) with $w_1 = \nabla \lg u_{\varepsilon}$, $w_2 = \nabla \lg v_{\varepsilon}$ and vice versa). In view of (15.8), taking a sequence $\varepsilon_k \rightarrow 0^+$ as $k \rightarrow \infty$ and using Fatou’s lemma in the previous computations we finally arrive to the conclusion that $v \nabla u = u \nabla v$ a.e. in Ω . Hence there is a constant κ such that $u = \kappa v$ a.e. in Ω and by continuity this equality holds everywhere in Ω .

Now we turn the attention to the case $1 < p < 2$ where the situation is similar as in the previous case. Applying the inequality (15.6) in (15.7) we obtain

$$\begin{aligned} 0 &\leq C(p) \int_{\Omega} (u_{\varepsilon} v_{\varepsilon})^p (u_{\varepsilon}^p + v_{\varepsilon}^p) \frac{\|v_{\varepsilon} \nabla u_{\varepsilon} - u_{\varepsilon} \nabla v_{\varepsilon}\|^2}{(v_{\varepsilon} \|\nabla u_{\varepsilon}\| + u_{\varepsilon} \|\nabla v_{\varepsilon}\|)^{2-p}} \, dx \\ &\leq -\lambda_1 \int_{\Omega} \left[\left(\frac{u}{u_{\varepsilon}} \right)^{p-1} - \left(\frac{v}{v_{\varepsilon}} \right)^{p-1} \right] (u_{\varepsilon}^p - v_{\varepsilon}^p) \, dx \end{aligned}$$

for every $\varepsilon > 0$. Using (15.8), we again arrive at the desired dependence $u = \kappa v$ for some constant κ .

As for the isolation of the first eigenvalue λ_1 , we proceed as follows. Since λ_1 is defined as the minimum of the quotient (15.4), it is isolated from the left. If v is an eigenfunction associated with an eigenvalue $\lambda > \lambda_1$ then v changes its sign in Ω . In fact, suppose that v does not change its sign in Ω . Then using the same method as in the previous part of the proof we get (for details we refer to [11])

$$0 \leq \int_{\Omega} (\lambda_1 - \lambda)(u^p - v^p) \, dx = (\lambda_1 - \lambda) \left(\frac{1}{\lambda_1} - \frac{1}{\lambda} \right)$$

what is a contradiction.

Now, suppose, by contradiction, that there exists a sequence of eigenvalues $\lambda_n \rightarrow \lambda_1 +$ and let u_n be the sequence of associated eigenfunctions such that $\|u_n\| = 1$. This sequence contains a weakly convergent subsequence in $W_0^{1,p}(\Omega)$, denoted again u_n , and hence strongly convergent in $L^p(\Omega)$. Since $u_n = -\Delta_p^{-1}(\Phi(u_n))$ (this is a usual argument in the theory of partial equations with p -Laplacian, we refer, e.g., to the monograph [103]), the sequence u_n converges strongly in $W_0^{1,p}(\Omega)$ to a function of the $W_0^{1,p}$ norm equal to

1 associated with λ_1 . However, by the Jegerov theorem, the sequence u_n converges uniformly to a function u except for a set of arbitrarily small Lebesgue measure. However, this is a contradiction with the fact that the eigenfunction associated with the first eigenvalue does not change its sign in Ω . \square

15.2. Picone’s identity for equations with p -Laplacian

Picone’s identity as presented in this subsection was proved in [118]. However, this identity can be found in various modifications (sometimes implicitly) also in other papers, e.g. in [9,10,83].

Consider a pair of partial differential operators with p -Laplacian

$$l[u] := \operatorname{div}(r(x)\|\nabla u\|^{p-2}\nabla u) + c(x)\Phi(u) = 0$$

and

$$L[u] := \operatorname{div}(R(x)\|\nabla u\|^{p-2}\nabla u) + C(x)\Phi(u) = 0.$$

It is assumed that r, c, R, C are defined in some bounded domain $G \subset \mathbb{R}^N$ with piecewise smooth boundary ∂G and that $r, R \in C^1(\overline{G})$ are positive functions in \overline{G} , and $c, C \in C(\overline{G})$. The domain $\mathcal{D}_l(G)$ of l is defined to be the set of all functions of the class $C^1(\overline{G})$ with the property that $r\|\nabla u\|^{p-2}\nabla u \in C^1(G) \cap C(\overline{G})$. The domain $\mathcal{D}_L(G)$ of L is defined similarly.

The proof of the below given N -dimensional extension of Picone’s identity is similar to that given in Section 1.

THEOREM 15.3. *Let $u \in \mathcal{D}_l(G)$, $v \in \mathcal{D}_L(G)$ and $v(x) \neq 0$ for $x \in G$. Then*

$$\begin{aligned} & \operatorname{div}\left(\frac{u}{\Phi(v)}[\Phi(v)r(x)\|\nabla u\|^{p-2}\nabla u - \Phi(u)R(x)\|\nabla v\|^{p-2}v]\right) \\ &= [r(x) - R(x)]\|\nabla u\|^p + [C(x) - c(x)]|u|^p \\ &+ R(x)\left[\|\nabla u\|^p + (p-1)\left\|\frac{u}{v}\nabla v\right\|^p - p\left\|\frac{u}{v}\nabla v\right\|^{p-2}(\nabla u)\left(\frac{u}{v}\nabla v\right)\right] \\ &+ \frac{u}{\Phi(v)}[\Phi(v)l[u] - \Phi(u)L[v]]. \end{aligned}$$

Taking $r = R, c = C$ in the previous theorem, and using the fact that if v is a solution of $l[v] = 0$ for which $v(x) \neq 0$ in G , then the function $w = \frac{r(x)\|\nabla v\|^{p-2}\nabla v}{\Phi(v)}$ is a solution of the Riccati-type partial differential equation

$$\operatorname{div} w + c(x) + (p-1)r^{1-q}(x)\|w\|^q = 0, \quad q = \frac{p}{p-1},$$

we have Picone’s identity in the special form

$$r(x)\|\nabla u\|^p - c(x)|u|^p = \operatorname{div}(w(x)|u|^p) + pr^{1-q}(x)\tilde{P}(r^{q-1}(x)\nabla u, w(x)\Phi(u)),$$

where

$$\tilde{P}(x, y) = \frac{\|x\|^p}{p} - \langle x, y \rangle + \frac{\|y\|^q}{q}.$$

As a consequence of Theorem 15.3 we have the following extension of the Leighton comparison theorem. The proof of this statement is again similar to the “ordinary” case, compare Section 8.1.

THEOREM 15.4. *Suppose that the boundary ∂G is of the class C^1 . If there exists a nontrivial solution $u \in \mathcal{D}_1(G)$ of $l[u] = 0$ such that $u = 0$ on ∂G and*

$$\int_G \{ [R(x) - r(x)]\|\nabla u\|^p - [C(x) - c(x)]|u|^p \} dx \leq 0,$$

then every solution $v \in \mathcal{D}_L(G)$ of $L[v] = 0$ must vanish at some point of G , unless v is a constant multiple of u .

Another consequence of Picone’s identity is the following Sturmian separation theorem.

THEOREM 15.5. *Suppose that G is the same as in the previous theorem and there exists a nontrivial solution $u \in \mathcal{D}_1(G)$ of $l[u] = 0$ with $u = 0$ on ∂G . Then every solution v of $l[u] = 0$ must vanish at some point of G , unless v is a constant multiple of u .*

REMARK 15.1. (i) There exist numerous papers dealing with various oscillation and spectral properties of PDEs with p -Laplacian. We recall here at least the papers [12,18,47,48, 70,75,80], but this is only a very limited sample of papers where equations with the p -Laplacian are treated.

(ii) If we study properties of solutions of PDEs with p -Laplacian

$$\operatorname{div}(\|\nabla u\|^{p-2}\nabla u) + c(x)\Phi(u) = 0 \tag{15.9}$$

in a radially symmetric domain $G = B_R = \{x \in \mathbb{R}^N: \|x\| \leq R\}$ with a radially symmetric potential c , i.e., $c(x) = b(\|x\|)$ for some $b: \mathbb{R}_+ \rightarrow \mathbb{R}$, then one can look for solutions in the radial form $u(x) = v(r) = v(\|x\|)$ and then v solved the ODE of the form (0.1)

$$\frac{d}{dr} \left[r^{N-1} \Phi \left(\frac{d}{dr} v \right) \right] + r^{N-1} b(r) = 0.$$

This method of the investigation of oscillatory properties of (15.9) has been used, e.g., in [70,136], see also the references given therein.

15.3. Second eigenvalue of p -Laplacian

In this subsection we briefly mention the results of the paper [13] which deals with the variational description of the second eigenvalue of p -Laplacian and with a nodal domain property of the associated eigenfunction. We again suppose that Ω is a bounded domain in \mathbb{R}^n .

We consider the eigenvalue problem (15.2) and we introduce the functionals

$$A(u) = \frac{1}{p} \int_{\Omega} \|\nabla u\|^p dx, \quad B(u) = \frac{1}{p} \int_{\Omega} |u|^p dx,$$

$$F(u) = A^2(u) - B(u).$$

It is clear that the critical point u of F associated to a critical value c (i.e., $F(u) = c$ and $F'(u) = 0$) is an eigenfunction associated to the eigenvalue

$$\lambda = \frac{1}{2\sqrt{-c}}.$$

Conversely, if $u \neq 0$ is an eigenfunction associated to a positive eigenvalue λ , $v = (2\lambda A(u))^{-\frac{1}{p}} u$ will be also an eigenfunction associated to $\lambda = \frac{1}{2A(v)}$ and v is a critical point of F associated to the critical value $c = -\frac{1}{4\lambda^2}$.

Let us consider the sequence $\{c_n\}_{n \in \mathbb{N}}$ defined by

$$c_n = \inf_{K \in \mathcal{A}_n} \sup_{v \in K} F(v), \tag{15.10}$$

where

$$\mathcal{A}_n = \{K \in W_0^{1,p}(\Omega) : K \text{ symmetrical compact and } \gamma(K) \geq n\}$$

and $\gamma(K)$ denotes the Krasnoselskii genus of K , i.e., the minimal integer n such that there exists a continuous odd mapping of $K \rightarrow \mathbb{R}^n \setminus \{0\}$. It can be proved (using the Palais–Smale condition for F) that the sequence c_n consists of the critical values of F and $c_n \rightarrow 0-$. The sequence of eigenvalues λ_n defined by

$$\lambda_n = \frac{1}{2\sqrt{-c_n}} \tag{15.11}$$

is positive, nondecreasing and tends to ∞ . Note that it is an open problem whether (15.11) describes *all* eigenvalues of (15.2) (in contrast to the scalar case $N = 1$, compare Section 13.2).

We denote by $Z(u) = \{x \in \Omega : u(x) = 0\}$ the so-called *nodal contour* of the function u and let $N(u)$ denote the number of components (the so-called *nodal domains*) of $\Omega \setminus Z(u)$. For each eigenfunction u associated to λ we define

$$N(\lambda) = \max\{N(u) : u \text{ is a solution of (15.2)}\}.$$

Now, at the end of this subsection, we present without proof the main result of [13]. In contrast to the scalar case, it is not known whether (15.10) and (15.11) describe *all* eigenvalues of (15.2). The next statement shows, among others, that the second eigenvalue λ_2 can be characterized by (15.11).

THEOREM 15.6. *For each eigenvalue λ of (15.2) $\lambda_{N(\lambda)} \leq \lambda$. Moreover, the value λ_2 given by (15.11) satisfies*

$$\lambda_2 = \inf \left\{ \lambda: \lambda \text{ positive eigenvalue of (15.2), } \lambda > \lambda_1 \right\}.$$

15.4. Equations involving pseudolaplacian

Another partial differential equation which reduces to half-linear equation (9.1) in the “ordinary” case is the partial differential equation with the so-called *pseudolaplacian*

$$\tilde{\Delta}_p u := \sum_{i=1}^N \frac{\partial}{\partial x_i} \Phi \left(\frac{\partial u}{\partial x_i} \right).$$

We consider the partial differential equation

$$\tilde{\Delta}_p u + c(x)\Phi(u) = 0 \tag{15.12}$$

and the associated energy functional

$$\begin{aligned} \mathcal{F}_p(u; \Omega) &:= \int_{\Omega} \left\{ \sum_{i=1}^N \left| \frac{\partial u}{\partial x_i} \right|^p - c(x)|u|^p \right\} dx \\ &= \int_{\Omega} \{ \|\nabla u\|_p^p - c(x)|u|^p \} dx, \end{aligned}$$

where $\|x\|_p = (\sum_{i=1}^N |x_i|^p)^{1/p}$ denotes the p -norm in \mathbb{R}^N . Another important object associated with (15.12) is a Riccati-type equation which we obtain as follows. Let u be a solution of (15.12) which is nonzero in Ω and denote

$$v := \left(\Phi \left(\frac{\partial u}{\partial x_1} \right), \dots, \Phi \left(\frac{\partial u}{\partial x_n} \right) \right), \quad w := \frac{v}{\Phi(u)}.$$

Then, using the fact that (15.12) can be written in the form $\operatorname{div} v = -c(x)\Phi(u)$, we have

$$\begin{aligned} \operatorname{div} w &= \frac{1}{\Phi^2(u)} \{ \Phi(u) \operatorname{div} v - \Phi'(u) \langle \nabla u, v \rangle \} \\ &= -c(x) - (p-1) \frac{|u|^{p-2}}{|u|^{2p-2}} \sum_{i=1}^N \left| \frac{\partial u}{\partial x_i} \right|^p \end{aligned}$$

$$\begin{aligned} &= -c(x) - (p - 1) \sum_{i=1}^N \left| \Phi \left(\frac{\partial u / \partial x_i}{u} \right) \right|^q \\ &= -c(x) - (p - 1) \|w\|_q^q, \end{aligned}$$

where $\langle \cdot, \cdot \rangle$ denotes the usual scalar product in \mathbb{R}^N , $q := \frac{p}{p-1}$ is the conjugate exponent of p and $\|x\|_q = (\sum_{i=1}^N |x_i|^q)^{1/q}$ denotes the q -norm in \mathbb{R}^N . Consequently, the vector variable w satisfies the Riccati-type equation

$$\operatorname{div} w + c(x) + (p - 1) \|w\|_q^q = 0. \tag{15.13}$$

For Equation (15.12) we can establish oscillation theory and theory for eigenvalue problems similar to that for classical p -Laplacian. An important role in this theory is played by the following Picone-type identity. For its proof and other results concerning PDEs with pseudolaplacian we refer to [25,26,28,62] and the reference given therein.

THEOREM 15.7. *Let w be a solution of (15.13) which is defined in $\bar{\Omega}$ and $u \in W^{1,p}(\Omega)$. Then*

$$\begin{aligned} \mathcal{F}_p(u; \Omega) &= \int_{\partial\Omega} |u(x)|^p w(x) \, dS \\ &\quad + p \int_{\Omega} \left\{ \frac{\|\nabla u(x)\|_p^p}{p} - \langle \nabla u(x), \Phi(u(x))w(x) \rangle \right. \\ &\quad \left. + \frac{\|w(x)\|_q^q |\Phi(u(x))|^q}{q} \right\} dx. \end{aligned}$$

Moreover, the last integral in this formula is always nonnegative, it equals zero only if $u \neq 0$ in $\bar{\Omega}$ and

$$w = \frac{1}{\Phi(u)} \left(\Phi \left(\frac{\partial u}{\partial x_1} \right), \dots, \Phi \left(\frac{\partial u}{\partial x_n} \right) \right).$$

16. Half-linear difference equations

In the last two decades, a considerable attention has been devoted to the oscillation theory of the Sturm–Liouville difference equation

$$\Delta(r_k \Delta x_k) + c_k x_{k+1} = 0, \tag{16.1}$$

where $\Delta x_k = x_{k+1} - x_k$ is the usual forward difference, r, c are real-valued sequences and $r_k \neq 0$. Oscillation theory parallel to that for the Sturm–Liouville differential equation (1.1) has been established and almost all oscillation and nonoscillation criteria have now their

discrete counterparts for (16.1). We refer to monographs [1,6,124] for general background. Basic tools of the linear discrete oscillation theory are the discrete quadratic functional

$$\mathcal{F}_d(x; 0, N) = \sum_{k=0}^N [r_k(\Delta x_k)^2 - c_k x_{k+1}^2],$$

the Riccati difference equation (related to (16.1) by the substitution $w = \frac{r\Delta x}{x}$)

$$\Delta w_k + c_k + \frac{w_k^2}{r_k + w_k} = 0 \quad (16.2)$$

and the link between them, the (reduced) discrete Picone identity

$$\mathcal{F}_d(x; 0, N) = w_k y_k^2 \Big|_{k=0}^{N+1} + \sum_{k=0}^N \frac{1}{r_k + w_k} (r_k \Delta x_k - w_k x_k)^2,$$

w being a solution of the Riccati equation, which is defined for $k = 0, \dots, N + 1$.

A natural idea, suggested by similarity of oscillation theories for linear equation (1.1) and half-linear equation (0.1), is to look for half-linear extension of these results and to establish a *discrete* half-linear oscillation theory parallel to that for (0.1). Therefore, the subject of this section is the half-linear *difference* equation

$$\Delta(r_k \Phi(\Delta x_k)) + c_k \Phi(x_{k+1}) = 0, \quad (16.3)$$

where r, c are real-valued sequences and $r_k \neq 0$. We will see that the results for (16.3) are similar to those for (0.1), but the proofs are sometimes more difficult. The reason is that the calculus of finite differences and sums is sometimes more cumbersome than the differential and integral calculus. For example, we have no discrete analogue of the chain rule for the differentiation of the composite function. On the other hand, there are some points where the discrete calculus is “easier”, for example, if an infinite series $\sum_{k=0}^{\infty} a_k$ is convergent, we have $\lim_{n \rightarrow \infty} a_n = 0$, while the convergence of the integral $\int_0^{\infty} f(t) dt$ gives generally no information about $\lim_{t \rightarrow \infty} f(t)$. Most of the results of this section are taken from the papers of Řehák [194–199].

16.1. Roundabout theorem for half-linear difference equations

The basic results of the discrete half-linear oscillation theory are established in the series of papers [194–199]. Here we present principal results of this theory.

First of all, let us note that in contrast to the continuous case, there is no problem with the existence and uniqueness for solutions of (16.3). Expanding the forward differences, this equation can be written as

$$r_{k+1} \Phi(x_{k+2} - x_{k+1}) - r_k \Phi(x_{k+1} - x_k) + c_k \Phi(x_{k+1}) = 0$$

and hence

$$x_{k+2} = x_{k+1} + \Phi^{-1} \left(\frac{1}{r_{k+1}} [r_k \Phi(x_{k+1} - x_k) - c_k \Phi(x_{k+1})] \right).$$

This means that given the initial conditions $x_0 = A, x_1 = B$, we can compute explicitly all other x_k . Moreover, given any $N \in \mathbb{N}$, the values x_2, \dots, x_N depend continuously (in the norm of \mathbb{R}^{N-1}) on x_0, x_1 . Let us also emphasize that general discrete oscillation theory can be established under the mere assumption $r_k \neq 0$, while we have to suppose that $r(t) > 0$ in the continuous case.

Oscillatory properties of (16.3) are defined using the concept of generalized zero points. We say that an interval $(m, m + 1]$ contains a *generalized zero* of a solution x of (16.3) if $x_m \neq 0$ and $x_m x_{m+1} r_m \leq 0$. If $r_m > 0$, a generalized zero of x is just the zero of x at $m + 1$ or the sign change $x_m x_{m+1} < 0$.

THEOREM 16.1. *The following statements are equivalent:*

- (i) Equation (16.3) is *disconjugate* on $[0, N]$, i.e., the solution \tilde{x} given by the initial conditions $\tilde{x}_0 = 0, r_0 \Phi(\tilde{x}_1) = 1$ has no generalized zero in $(0, N + 1]$.
- (ii) There exists a solution of (16.3) having no generalized zero in $[0, N + 1]$.
- (iii) There exists a solution w of the Riccati-type difference equation (related to (16.3) by the substitution $w_k = r_k \Phi(\Delta x_k / x_k)$)

$$\Delta w_k + c_k + w_k \left(1 - \frac{r_k}{\Phi(\Phi^{-1}(r_k) + \Phi^{-1}(w_k))} \right) = 0 \tag{16.4}$$

which is defined for every $k \in [0, N + 1]$ and satisfies $r_k + w_k > 0$ for $k \in [0, N]$.

- (iv) The discrete p -degree functional

$$\mathcal{F}_d(y; 0, N) = \sum_{k=0}^N [r_k |\Delta y_k|^p - c_k |y_{k+1}|^2]$$

is positive for every nontrivial $y = \{y_k\}_{k=0}^{N+1}$ satisfying $y_0 = 0 = y_{N+1}$.

PROOF. (i) \Rightarrow (ii): Consider the solution x of (16.3) given by the initial condition $x_0 = \varepsilon, x_1 = \Phi^{-1}(1/r_0)$, where $\varepsilon > 0$ is sufficiently small. Then according to the above mentioned continuous dependence of x_2, \dots, x_{N+1} on x_0, x_1 we still have $r_k x_k x_{k+1} > 0, k = 1, \dots, N$, when $\varepsilon > 0$ is sufficiently small, and $r_0 x_0 x_1 > 0$ as well, i.e., the solution x has no generalized zero in $[0, N + 1]$.

(ii) \Rightarrow (iii): Let x be a solution of (16.3) having no generalized zeros in $[0, N + 1]$, and let $w_k = \frac{r_k \Phi(\Delta x_k)}{\Phi(x_k)}$. Then

$$\begin{aligned} \Delta w_k &= \frac{\Delta(r_k \Phi(\Delta x_k)) \Phi(x_k) - r_k \Phi(\Delta x_k) (\Phi(x_{k+1}) - \Phi(x_k))}{\Phi(x_{k+1}) \Phi(x_k)} \\ &= -c_k - w_k + \frac{r_k \Phi(\Delta x_k)}{\Phi(x_k + \Delta x_k)} = -c_k - w_k + \frac{r_k \Phi(\Delta x_k)}{\Phi(x_k) \Phi(1 + \frac{\Delta x_k}{x_k})} \end{aligned}$$

$$\begin{aligned}
&= -c_k - w_k \left(1 - \frac{1}{\Phi(1 + \Phi^{-1}(\frac{w_k}{r_k}))} \right) \\
&= -c_k - w_k \left(1 - \frac{r_k}{\Phi(\Phi^{-1}(r_k) + \Phi^{-1}(w_k))} \right).
\end{aligned}$$

Moreover, $r_k x_k x_{k+1} > 0 \Leftrightarrow r_k \Phi(x_k) \Phi(x_{k+1}) > 0$ and

$$\begin{aligned}
r_k \Phi(x_k) \Phi(x_{k+1}) &= r_k \Phi(x_k) \Phi(x_k + \Delta x_k) \\
&= \Phi^2(x_k) \Phi \left(\Phi^{-1}(r_k) + \Phi^{-1}(r_k) \frac{\Delta x_k}{x_k} \right) \\
&= \Phi^2(x_k) \Phi(\Phi^{-1}(r_k) + \Phi^{-1}(w_k)),
\end{aligned}$$

hence $r_k x_k x_{k+1} > 0$ if and only if $\Phi^{-1}(r_k) + \Phi^{-1}(w_k) > 0$, i.e., if and only if $r_k + w_k > 0$.

(iii) \Rightarrow (iv): Let w be a solution of (16.4) such that $r_k + w_k > 0$, $k = 0, \dots, N$. Then

$$w_{k+1} = -c_k + \frac{r_k w_k}{\Phi(\Phi^{-1}(r_k) + \Phi^{-1}(w_k))}$$

and for any sequence $y = \{y_k\}_{k=0}^{N+1}$ we have

$$\begin{aligned}
\Delta(w_k |y_k|^p) &= w_{k+1} |y_{k+1}|^p - w_k |y_k|^p \\
&= -c_k |y_{k+1}|^p + \frac{r_k w_k |y_k + \Delta y_k|^p}{\Phi(\Phi^{-1}(w_k) + \Phi^{-1}(r_k))} \\
&\quad - w_k |y_k|^p + r_k |\Delta y_k|^p - r_k |\Delta y_k|^p.
\end{aligned}$$

Using the fact that $y_0 = 0 = y_{N+1}$, the summation of the last equality from $k = 0$ to $k = N$ gives

$$\mathcal{F}_d(y; 0, N) = r_k |\Delta y_k|^p - \frac{r_k w_k |y_k + \Delta y_k|^p}{\Phi(\Phi^{-1}(w_k) + \Phi^{-1}(r_k))} - w_k |y_k|^p. \quad (16.5)$$

The right-hand side of (16.5) is always nonnegative and it is zero if and only if $w_k = r_k \Phi(\Delta y_k / y_k)$ (see [195]), but this means that $y \equiv 0$ since $y_0 = 0$. Hence $\mathcal{F}_d(y; 0, N) > 0$ for every nontrivial y with $y_0 = 0 = y_{N+1}$.

(iv) \Rightarrow (i): Suppose that $\mathcal{F}_d > 0$ and (16.3) is not disconjugate in $[0, N + 1]$, i.e., the solution x given by the initial condition $x_0 = 0$, $x_1 = \Phi^{-1}(1/r_0)$ has a generalized zero in the interval $[0, N + 1]$, i.e., $r_m x_m x_{m+1} < 0$ or $x_{m+1} = 0$ for some $m \in \{1, \dots, N\}$. Define $y = \{y_k\}_{k=0}^{N+1}$ as follows

$$y_k = \begin{cases} x_k, & k = 0, \dots, m, \\ 0, & k = m + 1, \dots, N + 1. \end{cases}$$

Then we have (using summation by parts applied to $\mathcal{F}_d(x; 0, m - 1)$)

$$\begin{aligned} \mathcal{F}_d(y; 0, N) &= \mathcal{F}_d(x; 0, m - 1) + [r_m |\Delta y_m|^p] = r_k \Phi(\Delta x_k) x_k \Big|_0^m + r_m |x_m|^p \\ &= |x_m|^p \left[r_m \frac{\Phi(\Delta x_m)}{\Phi(x_m)} + r_m \right] = |x_m|^p [w_m + r_m] \leq 0 \end{aligned}$$

since $w_m + r_m \leq 0$ if and only if $r_m x_m x_{m+1} \leq 0$ as we have shown in the previous part of this proof. □

REMARK 16.1. (i) The previous theorem shows that (16.3) can be classified as oscillatory or nonoscillatory in the same way as in the continuous case. Equation (16.3) is said to be *nonoscillatory* if there exists $N \in \mathbb{N}$ such that (16.3) is disconjugate on $[N, M]$ for every $M > N$, in the opposite case (16.3) is said to be *oscillatory*.

(ii) Theorem 16.1 also shows that not only Sturmian separation, but also Sturmian comparison theorem extends verbatim to (16.3). In particular, if $0 \neq R_k \leq r_k$ and $C_k \geq c_k$ for large k and the equations

$$\Delta(R_k \Phi(\Delta y_k)) + C_k \Phi(y_{k+1}) = 0$$

is nonoscillatory, then (16.3) is also nonoscillatory. The argument in the proof of this statement is the same as that for (0.1).

16.2. Discrete Leighton–Wintner criterion

In this criterion, similarly as in the continuous case, Equation (16.3) is viewed as a perturbation of the one-term equation

$$\Delta(r_k \Phi(\Delta x_k)) = 0. \tag{16.6}$$

In accordance with the continuous case, we need (16.6) to be nonoscillatory in this approach, so we suppose that $r_k > 0$ for large k , otherwise this equation is oscillatory—each sign change of r_k is a generalized zero of the constant solution $x_k \equiv 1$.

THEOREM 16.2. *Suppose that $r_k > 0$ for large k ,*

$$\sum_{k=1}^{\infty} r_k^{1-q} = \infty \quad \text{and} \quad \sum_{k=1}^{\infty} c_k = \infty. \tag{16.7}$$

Then (16.3) is oscillatory.

PROOF. We present here the complete proof in order to show that its idea is exactly the same as in the continuous case. Let $N \in \mathbb{N}$ be arbitrary. Define the class of sequences

$$D(N) := \{y = \{y_k\}_{k=N}^{\infty}, y_N = 0, \exists M > N: y_k = 0 \text{ for } k \geq M\} \tag{16.8}$$

and for $N < n < m < M$ (which will be determined later) define a sequence $y \in \mathcal{D}(N)$ as follows

$$y_k = \begin{cases} 0, & k = N, \\ (\sum_{j=N}^{k-1} r_j^{1-q})(\sum_{j=N}^{n-1} r_j^{1-q})^{-1}, & N + 1 \leq k \leq n, \\ 1, & n + 1 \leq k \leq m - 1, \\ (\sum_{j=k}^{M-1} r_j^{1-q})(\sum_{j=m}^{M-1} r_j^{1-q})^{-1}, & m \leq k \leq M - 1, \\ 0, & k \geq M. \end{cases}$$

Then we have

$$\begin{aligned} \mathcal{F}_d(y; N, \infty) &= \sum_{k=N}^{\infty} [r_k |\Delta y_k|^p - c_k |y_{k+1}|^p] = \sum_{k=N}^{M-1} [r_k |\Delta y_k|^p - c_k |y_{k+1}|^p] \\ &= \left(\sum_{k=N}^{n-1} + \sum_{k=n}^{m-1} + \sum_{k=m}^{M-1} \right) [r_k |\Delta y_k|^p - c_k |y_{k+1}|^p] \\ &= \left(\sum_{k=N}^{n-1} r_k^{1-q} \right)^{-1} - \sum_{k=N}^{n-1} c_k |y_{k+1}|^p - \sum_{k=n}^{m-1} c_k - \sum_{k=m}^{M-1} c_k |y_{k+1}|^p \\ &\quad + \left(\sum_{k=m}^{M-1} r_k^{1-q} \right)^{-1}. \end{aligned}$$

Now, using the discrete version of the second mean value theorem of the summation calculus (see, e.g., [57]), there exists $\tilde{m} \in [m - 1, M - 1]$ such that

$$\sum_{k=m}^{M-1} c_k |y_{k+1}|^p \geq \sum_{k=m}^{\tilde{m}} c_k.$$

Let $n > N$ be fixed. Since (16.7) holds, for every $\varepsilon > 0$ there exist $M > m > n$ such that

$$\sum_{k=n}^{\tilde{m}} c_k > \mathcal{F}_d(y; N, n - 1) + \varepsilon \quad \text{whenever } \tilde{m} > m \text{ and } \left(\sum_{k=m}^{M-1} r_k^{1-q} \right)^{-1} < \varepsilon.$$

Consequently, we have

$$\mathcal{F}_d(y; N, \infty) \leq \mathcal{F}_d(y; N, n - 1) - \sum_{k=n}^{\tilde{m}} c_k + \left(\sum_{k=m}^{M-1} r_k^{1-q} \right)^{-1} < 0$$

what we needed to prove. □

In Section 9 we have presented an alternative proof of the continuous Leighton–Wintner criterion—based on the Riccati technique. Next we show difficulties in the attempt to follow this idea also in the discrete case. The “Riccati” proof goes by contradiction. Suppose that (16.7) holds and (16.3) is nonoscillatory, i.e., there exists a solution of (16.4) satisfying $r_k + w_k > 0$ for large k . The summation of (16.4) from N to $k - 1$, where N, k are sufficiently large, we have

$$\begin{aligned}
 w_k &= w_N - \sum_{j=N}^{k-1} c_j - \sum_{j=N}^{k-1} w_j \left(1 - \frac{r_j}{\Phi(\Phi^{-1}(r_j) + \Phi^{-1}(w_j))} \right) \\
 &\leq - \sum_{j=N}^{k-1} w_j \left(1 - \frac{r_j}{\Phi(\Phi^{-1}(r_j) + \Phi^{-1}(w_j))} \right) =: G_k.
 \end{aligned}$$

In the continuous case we obtained the analogous inequality

$$w(t) \leq -(p - 1) \int_T^t r^{1-q}(s) |w(s)|^q ds =: G(t)$$

which leads to the inequality

$$\frac{G'(t)}{G^q(t)} \leq \frac{r^{1-q}}{\int_T^t r^{1-q}(s) ds} \tag{16.9}$$

and integrating this inequality we got $\int^\infty r^{1-q}(t) dt < \infty$, a contradiction.

The discrete analogue of (16.9) is the inequality $w_k \leq G_k$ and to get a contradiction from this inequality is a difficult problem even in the linear case $p = 2$.

16.3. Riccati inequality

The equivalence of disconjugacy of (16.3) and solvability of (16.4) (satisfying $r_k + w_k > 0$), coupled with the Sturmian comparison theorem for (16.3) mentioned in Remark 16.1, lead to the following refinement of the Riccati equivalence.

THEOREM 16.3. *Equation (16.3) is nonoscillatory if and only if there exists a sequence w_k , with $r_k + w_k > 0$ for large k , such that*

$$R[w_k] := \Delta w_k + c_k + w_k \left(1 - \frac{r_k}{\Phi(\Phi^{-1}(w_k) + \Phi^{-1}(r_k))} \right) \leq 0. \tag{16.10}$$

PROOF. The part “only if” follows immediately from Theorem 16.1. For the part “if”, let us denote $l[u_k] := \Delta(r_k \Phi(\Delta u_k)) + c_k \Phi(u_{k+1})$. We will show that if there exists u_k such that

$$r_k u_k u_{k+1} > 0 \quad \text{and} \quad u_{k+1} l[u_k] \leq 0 \tag{16.11}$$

for $k \in [N, \infty)$, $N \in \mathbb{N}$, then (16.3) is disconjugate on $[N, \infty)$ and thus nonoscillatory. Therefore, suppose that a sequence u_k satisfying (16.11) on $[N, \infty)$ exists. Then $S_k := -u_{k+1}l[u_k]$ is a nonnegative sequence on this discrete interval. Further, set $\tilde{r}_k = r_k$ and $\tilde{c}_k = c_k - S_k/|u_{k+1}|^p$. Hence $\tilde{c}_k \geq c_k$ and

$$\Delta(\tilde{r}_k \Phi(\Delta u_k)) + \tilde{c}_k \Phi(u_{k+1}) = \Delta(r_k \Phi(\Delta u_k)) + \left(c_k - \frac{S_k}{|u_{k+1}|^p} \right) \Phi(u_{k+1}) = 0.$$

Thus equation $\Delta(\tilde{r}_k \Phi(\Delta u_k)) + \tilde{c}_k \Phi(u_{k+1}) = 0$ is disconjugate on $[N, \infty)$ and therefore (16.3) is also disconjugate on $[N, \infty)$ by Sturm comparison theorem.

To finish the proof, it remains to find a sequence u_k satisfying (16.11). Let w_k satisfy (16.10) with $r_k + w_k > 0$ on $[N, \infty)$ and let

$$u_k = \prod_{j=N}^{k-1} (1 + \Phi^{-1}(w_j/r_j)), \quad k > N,$$

be a solution of the first order difference equation

$$\Delta u_k = \Phi^{-1}(w_k/r_k)u_k, \quad u_N = 1,$$

Then $u_k \neq 0$ since

$$1 + \Phi^{-1}(w_k/r_k) = \frac{1}{\Phi^{-1}(r_k)} [\Phi^{-1}(r_k) + \Phi^{-1}(w_k)] \neq 0,$$

recall that $\Phi^{-1}(r_k) + \Phi^{-1}(w_k) > 0$ if and only if $w_k + r_k > 0$. Further,

$$\begin{aligned} u_{k+1}l[u_k] &= u_{k+1} \left[\Delta(r_k \Phi(\Delta u_k)) + c_k \Phi(u_{k+1}) \right] - \frac{|u_{k+1}|^p r_k \Phi(\Delta u_k) \Delta \Phi(u_k)}{\Phi(u_k) \Phi(u_{k+1})} \\ &\quad + \frac{|u_{k+1}|^p r_k \Phi(\Delta u_k) \Delta \Phi(u_k)}{\Phi(u_k) \Phi(u_{k+1})} \\ &= u_{k+1} \Phi(u_{k+1}) \frac{\Delta(r_k \Phi(\Delta u_k)) \Phi(u_k) - r_k \Phi(\Delta u_k) \Delta \Phi(u_k)}{\Phi(u_k) \Phi(u_{k+1})} \\ &\quad + |u_{k+1}|^p c_k + |u_{k+1}|^p \frac{r_k \Phi(\Delta u_k)}{\Phi(u_k)} \left(1 - \frac{\Phi(u_k)}{\Phi(u_{k+1})} \right) \\ &= |u_{k+1}|^p R[w_k] \leq 0, \end{aligned}$$

for $k \in [N, \infty)$, since $w_k = \frac{r_k \Phi(\Delta u_k)}{\Phi(u_k)}$ and

$$\frac{\Phi(u_k)}{\Phi(u_{k+1})} = \frac{1}{\Phi(1 + \frac{\Delta u_k}{u_k})} = \frac{r_k}{\Phi(\Phi^{-1}(r_k) + \Phi^{-1}(w_k))}.$$

This completes the proof. □

16.4. Hille–Nehari nonoscillation criterion

The following theorem is the discrete version of Theorem 5.4. This statement is one of the main results of [71].

THEOREM 16.4. *Suppose that $r_k > 0$ for large k , $\sum^\infty c_k = \lim_{k \rightarrow \infty} \sum^k c_j$ is convergent and*

$$\lim_{k \rightarrow \infty} \frac{r_k^{1-q}}{\sum^{k-1} r_j^{1-q}} = 0. \tag{16.12}$$

If

$$\limsup_{k \rightarrow \infty} \left(\sum^{k-1} r_j^{1-q} \right)^{p-1} \left(\sum_{j=k}^\infty c_j \right) < \frac{1}{p} \left(\frac{p-1}{p} \right)^{p-1} \tag{16.13}$$

and

$$\liminf_{k \rightarrow \infty} \left(\sum^{k-1} r_j^{1-q} \right)^{p-1} \left(\sum_{j=k}^\infty c_j \right) > -\frac{2p-1}{p} \left(\frac{p-1}{p} \right)^{p-1} \tag{16.14}$$

then (16.3) is nonoscillatory.

PROOF. It is sufficient to show that the generalized Riccati inequality (16.10) has a solution w with $r_k + w_k > 0$ in a neighborhood of infinity. We recommend the reader to compare this proof with the proof of Theorem 5.4 to see difference between discrete and continuous case.

Set

$$w_k = C \left(\sum^{k-1} r_j^{1-q} \right)^{1-p} + \sum_{j=k}^\infty c_j, \tag{16.15}$$

where C is a suitable constant, which will be specified later. The following equalities hold by the Lagrange mean value theorem

$$\Delta \left(\sum^{k-1} r_j^{1-q} \right)^{1-p} = (1-p)r_k^{1-q} \eta_k^{-p},$$

where $\sum^{k-1} r_j^{1-q} \leq \eta_k \leq \sum^k r_j^{1-q}$. Similarly

$$1 - \frac{r_k}{\Phi(\Phi^{-1}(r_k) + \Phi^{-1}(w_k))}$$

$$\begin{aligned}
 &= \frac{1}{\Phi(\Phi^{-1}(r_k) + \Phi^{-1}(w_k))} \{ \Phi(\Phi^{-1}(r_k) + \Phi^{-1}(w_k)) - \Phi(\Phi^{-1}(r_k)) \} \\
 &= \frac{p-1}{\Phi(\Phi^{-1}(r_k) + \Phi^{-1}(w_k))} |\xi|^{p-2} \Phi^{-1}(w_k),
 \end{aligned}$$

where ξ_k is between $\Phi^{-1}(r_k)$ and $\Phi^{-1}(r_k) + \Phi^{-1}(w_k)$. Hence

$$\Phi^{-1}(r_k) - |\Phi^{-1}(w_k)| \leq \xi_k \leq \Phi^{-1}(r_k) + |\Phi^{-1}(w_k)|$$

and

$$\frac{|w_k|}{r_k} = \left(\frac{r_k^{1-q}}{\sum_{j=k}^{k-1} r_j^{1-q}} \right)^{p-1} \left| C + \left(\sum_{j=k}^{k-1} r_j^{1-q} \right)^{p-1} \left(\sum_{j=k}^{\infty} c_j \right) \right|.$$

Hence $w_k/r_k \rightarrow 0$ for $k \rightarrow \infty$ according to (16.12), (16.13) and (16.14).

Further, we have

$$\begin{aligned}
 \Delta w_k + c_k - w_k &\left(1 - \frac{r_k}{\Phi(\Phi^{-1}(r_k) + \Phi^{-1}(w_k))} \right) \\
 &= (1-p) C r_k^{1-q} \eta_k^{-p} + \frac{(p-1)|w_k|^q \xi_k^{p-2}}{\Phi(\Phi^{-1}(r_k) + \Phi^{-1}(w_k))} \\
 &= (p-1) r_k^{1-q} \left\{ \frac{|w_k|^q |\xi_k|^{p-2} r_k^{q-1}}{\Phi(\Phi^{-1}(r_k) + \Phi^{-1}(w_k))} - \frac{C}{\eta_k^p} \right\} \\
 &= (p-1) \frac{r_k^{1-q}}{(\sum_{j=k}^{k-1} r_j^{1-q})^p} \left\{ \frac{|C + (\sum_{j=k}^{k-1} r_j^{1-q})^{p-1} \sum_{j=k}^{\infty} c_j|^q |\xi_k|^{p-2} r_k^{q-1}}{\Phi(\Phi^{-1}(r_k) + \Phi^{-1}(w_k))} \right. \\
 &\quad \left. - \frac{C(\sum_{j=k}^{k-1} r_j^{1-q})^p}{\eta_k^p} \right\} \\
 &\leq \frac{(p-1) r_k^{1-q}}{(\sum_{j=k}^{k-1} r_j^{1-q})^p} \left\{ \left| C + \left(\sum_{j=k}^{k-1} r_j^{1-q} \right)^{p-1} \left(\sum_{j=k}^{\infty} c_j \right) \right|^q \gamma_k - \frac{C(\sum_{j=k}^{k-1} r_j^{1-q})^p}{(\sum_{j=k}^k r_k^{1-q})^p} \right\},
 \end{aligned}$$

where

$$\gamma_k = \frac{|\xi_k|^{p-2} r_k^{1-q}}{\Phi(\Phi^{-1}(r_k) + \Phi^{-1}(w_k))}.$$

Concerning the asymptotic behavior of this sequence and of $(\sum^{k-1} r_j^{1-q})(\sum^k r_k^{1-q})^{-1}$, we have

$$\lim_{k \rightarrow \infty} \frac{\sum^k r_j^{1-q}}{\sum^{k-1} r_j^{1-q}} = \lim_{k \rightarrow \infty} \frac{r_k^{1-q} + \sum^{k-1} r_j^{1-q}}{\sum^{k-1} r_j^{1-q}} = 1$$

since (16.12) holds. Further,

$$\frac{|\xi_k|^{p-2} r_k^{1-q}}{\Phi(\Phi^{-1}(r_k) + \Phi^{-1}(w_k))} \leq \frac{r_k^{1-q} (\Phi^{-1}(r_k) + \Phi^{-1}(|w_k|))^{p-2}}{\Phi(\Phi^{-1}(r_k) - \Phi^{-1}(|w_k|))} \rightarrow 1$$

as $k \rightarrow \infty$ since $\frac{|w_k|}{r_k} \rightarrow 0$ as $k \rightarrow \infty$. Consequently,

$$\limsup_{k \rightarrow \infty} \gamma_k \leq 1. \tag{16.16}$$

Now, inequalities (16.13), (16.14) imply the existence of $\varepsilon > 0$ such that

$$\begin{aligned} & -\frac{2p-1}{p} \left(\frac{p-1}{p}\right)^{p-1} + \varepsilon \\ & < \left(\sum^{k-1} r_j^{1-q}\right)^{p-1} \left(\sum_{j=k}^{\infty} c_j\right) < \frac{1}{p} \left(\frac{p-1}{p}\right)^{p-1} - \varepsilon \end{aligned} \tag{16.17}$$

for k sufficiently large. Let $\tilde{\gamma}_k = \gamma_k^{\frac{1}{q}}$, $\tilde{\varepsilon} = \varepsilon \left(\frac{p}{p-1}\right)^{p-1}$ and let $C = \left(\frac{p-1}{p}\right)^p$ in (16.15). According to (16.16) $\tilde{\gamma}_k < \frac{1}{1-\tilde{\varepsilon}}$ for large k and

$$\begin{aligned} \tilde{\gamma}_k < \frac{1}{1-\tilde{\varepsilon}} & \iff 1 > \left[1 - \left(\frac{p}{p-1}\right)^{p-1} \varepsilon\right] \tilde{\gamma}_k \\ & \iff \left(\frac{p-1}{p}\right)^{p-1} > \left(\frac{p-1}{p}\right)^{p-1} \left[\frac{p-1}{p} + \frac{1}{p} - \left(\frac{p}{p-1}\right)^{p-1} \varepsilon\right] \tilde{\gamma}_k \\ & \iff \left(\frac{p-1}{p}\right)^{\frac{p}{q}} > \left[\left(\frac{p-1}{p}\right)^p + \frac{1}{p} \left(\frac{p-1}{p}\right)^{p-1} - \varepsilon\right] \tilde{\gamma}_k \\ & \iff \frac{C^{\frac{1}{q}} - C \tilde{\gamma}_k}{\tilde{\gamma}_k} > \frac{1}{p} \left(\frac{p-1}{p}\right)^{p-1} - \varepsilon. \end{aligned}$$

Therefore, the second inequality in (16.17) implies

$$C^{\frac{1}{q}} > \left[C + \left(\sum^{k-1} r_j^{1-q}\right)^{p-1} \left(\sum_{j=k}^{\infty} c_j\right) \right] \tilde{\gamma}_k.$$

By a similar computation (using the first inequality in (16.17)) we get

$$-C^{\frac{1}{q}} < \left[C + \left(\sum_{j=k}^{k-1} r_j^{1-q} \right)^{p-1} \left(\sum_{j=k}^{\infty} c_j \right) \right] \tilde{\gamma}_k.$$

Consequently,

$$\left| C + \left(\sum_{j=k}^{k-1} r_j^{1-q} \right)^{p-1} \left(\sum_{j=k}^{\infty} c_j \right) \right|^q < C$$

for large k and hence $R[w_k] \leq 0$. Finally, since $r_k > 0$ and $w_k/r_k \rightarrow 0$ as $k \rightarrow \infty$, we have $r_k + w_k > 0$ for large k and the proof is complete. □

REMARK 16.2. If we compare the previous statement with Theorem 5.4 (which is a continuous counterpart of this theorem), we see that assumption (16.12) has no continuous analogue. This is a consequence of the fact that we have no equivalence of the differentiation chain rule in the discrete case, and its partial discrete substitution—the Lagrange mean value theorem—need additional assumptions.

16.5. Half-linear dynamic equations on time scales

By a *time scale* \mathbb{T} (an alternative terminology is *measure chain*) we understand any closed subset of the real numbers \mathbb{R} with the usual topology inherited from \mathbb{R} . Typical examples of time scales are $\mathbb{T} = \mathbb{R}$ and $\mathbb{T} = \mathbb{Z}$ – the set of integers. The operators $\rho, \sigma : \mathbb{T} \rightarrow \mathbb{T}$ are defined by

$$\sigma(t) = \inf\{s \in \mathbb{T} : s > t\}, \quad \rho(t) = \sup\{s \in \mathbb{T} : s < t\}$$

and are called the *right jump operator* and *left jump operator*, respectively. The quantity $\mu(t) = \sigma(t) - t$ is called the *graininess* of \mathbb{T} . If $f : \mathbb{T} \rightarrow \mathbb{R}$, the generalized Δ -derivative is defined by

$$f^\Delta(t) = \lim_{s \rightarrow t, \sigma(s) \neq t} \frac{f(\sigma(s)) - f(t)}{\sigma(s) - t}$$

and $f^\Delta(t) = f'(t)$ if $\mathbb{T} = \mathbb{R}$ and $f^\Delta(t) = \Delta f(t) = f(t + 1) - f(t)$.

Now consider the linear dynamic equation on a time scale \mathbb{T}

$$(r(t)x^\Delta)^\Delta + c(t)x^\sigma = 0, \tag{16.18}$$

where $x^\sigma = x \circ \sigma$ and $r, c : \mathbb{T} \rightarrow \mathbb{R}$, and its half-linear extension

$$(r(t)\Phi(x^\Delta))^\Delta + c(t)\Phi(x^\sigma) = 0. \tag{16.19}$$

Obviously, (16.19) reduces to (0.1) if $\mathbb{T} = \mathbb{R}$ and to (16.3) if $\mathbb{T} = \mathbb{Z}$, respectively. The basic facts of the time scale calculus can be found in [109] and the general theory of dynamic equations on time scales is presented in [29,30].

Concerning (16.18), oscillation theory of this dynamic equation is established in [97]. The half-linear extension of this theory can be found in the recent paper [200], where it is shown that under the assumption $r(t) \neq 0$, the times scale Riccati equation

$$w^\Delta + c(t) + S[w, r](t) = 0,$$

where

$$S[w, r](t) = \lim_{\lambda \rightarrow \mu(t)} \frac{w(t)}{\lambda} \left(1 - \frac{r(t)}{\Phi(\Phi^{-1}(r(t))) + \lambda \Phi^{-1}(w(t))} \right),$$

and the p -degree functional (involving the time scale integral)

$$\mathcal{F}(y; a, b) = \int_a^b [r(t)|y^\Delta|^p - c(t)|y^\sigma|^p] \Delta t$$

play the same role as their continuous and discrete counterparts. We refer to the above mentioned paper [200] for details.

References

- [1] R.P. Agarwal, *Difference Equations and Inequalities, Theory, Methods and Applications*, 2nd ed., Dekker, New York–Basel (2000).
- [2] R.P. Agarwal, S.R. Grace, *Oscillation criteria for second order half-linear differential equations with deviating arguments*, Dyn. Contin. Discrete Impuls. Syst., Ser. A, Math. Anal. **9** (2002), 217–224.
- [3] R.P. Agarwal, S.R. Grace, D. O'Regan, *Oscillation Theory of Second Order Linear, Half-Linear, Superlinear and Sublinear Dynamic Equations*, Kluwer Academic, Dordrecht/Boston/London (2002).
- [4] R.P. Agarwal, S.L. Shieh, C.C. Yeh, *Oscillation criteria for second order retarded differential equations*, Math. Comput. Modelling **26** (1997), 1–11.
- [5] C.D. Ahlbrandt, D.B. Hinton, R.T. Lewis, *The effect of variable change on oscillation and disconjugacy criteria with applications to spectral theory and asymptotic theory*, J. Math. Anal. Appl. **81** (1981), 234–277.
- [6] C.D. Ahlbrandt, A.C. Peterson, *Discrete Hamiltonian Systems: Difference Equations, Continued Fractions, and Riccati Equations*, Kluwer Academic, Boston (1996).
- [7] W. Allegretto, *Sturmian type theorems for solutions of elliptic nonlinear problems*, Nonlinear Differential Equations Appl. **7** (2000), 309–321.
- [8] W. Allegretto, *Sturmian theorems for degenerate elliptic equations*, Proc. Amer. Math. Soc. **129** (2001), 3031–3035.
- [9] W. Allegretto, Y.X. Huang, *A Picone's identity for the p -Laplacian and applications*, Nonlinear Anal. **32** (1998), 819–830.
- [10] W. Allegretto, Y.X. Huang, *Principal eigenvalues and Sturm comparison via Picone's identity*, J. Differential Equations **156** (1999), 427–438.
- [11] A. Anane, *Simplicité et isolation de la première valeur propre du p -laplacien avec poids*, C. R. Acad. Sci. Paris, Ser. I **305** (1987), 725–728.
- [12] A. Anane, O. Charkone, J.-P. Gossez, *Spectre d'ordre supérieur et problèmes de non-résonance*, C. R. Acad. Sci. Paris, Ser. I **325** (1997), 33–36.

- [13] A. Anane, N. Tsouli, *On the second eigenvalue of the p -Laplacian*, Nonlinear Notes in Mathematics, A. Benkirane, J.-P. Gosez, eds., Pitman Research Notes in Mathematics, Vol. 343, Longman, Harlow (1996), 1–9.
- [14] J. Andres, *On the criterion of de la Vallée Poussin*, Publ. Math. (Debrecen) **45** (1994), 145–152.
- [15] F.V. Atkinson, Á. Elbert, *An extension of Milloux theorem to half-linear differential equations*, EJQTDE, Proc. 6th Coll. QTDE **2000** (8) (2000), 1–10.
- [16] B. Aynlar, A. Tiryaki, *Oscillation theorems for nonlinear second order differential equations*, Comput. Math. Appl. **44** (2002), 529–538.
- [17] R. Bellman, *Stability Theory of Differential Equations*, McGraw–Hill, New York–Toronto–London (1969).
- [18] Ch. Bennewitz, Y. Saitō, *An embedding norm and the Lindqvist trigonometric functions*, Electron J. Differential Equations **2002** (86) (2002), 1–6.
- [19] A. Besicovitch, *Almost Periodic Functions*, Dover, New York (1954).
- [20] I. Bihari, *Ausdehnung der Sturmischen Oszillations and Vergleichungsärte auf die Lösungen gewisser nicht-linearen Differenzialgleichungen zweiter Ordnung*, Publ. Math. Inst. Hungar. Acad. Sci. **2** (1957), 159–173.
- [21] I. Bihari, *An oscillation theorem concerning the half-linear differential equation of the second order*, Publ. Math. Inst. Hungar. Acad. Sci. Ser. A **8** (1963), 275–279.
- [22] I. Bihari, *On the second order half-linear differential equation*, Studia Sci. Math. Hungar. **3** (1968), 411–437.
- [23] I. Bihari, *Asymptotic results concerning the equation $x''|x'|^{n-1} + a(t)x^{*n} = 0$* , Studia Sci. Math. Hungar. **19** (1984), 151–157.
- [24] P.A. Binding, P. Drábek, Y.X. Huang, *The range of the p -Laplacian*, Appl. Math. Lett. **10** (1997), 77–82.
- [25] G. Bognár, *On the solution of some nonlinear boundary value problem*, Publ. Univ. Miskolc, Ser. D, Nat. Sci. Math. **36** (1995), 13–22.
- [26] G. Bognár, *Existence theorems for eigenvalues of a nonlinear eigenvalue problem*, Commun. Appl. Nonlinear Anal. **4** (1997), 93–102.
- [27] G. Bognár, *On the roots of the solution of generalized Bessel equation*, Proceedings of CDDE 2002, M. Bartušek, O. Došlý, eds., Masaryk University Press, Brno (2003), 33–43.
- [28] G. Bognár, O. Došlý, *The application of Picone's identity for some nonlinear elliptic differential equations*, Acta Math. Univ. Comenianae **72** (2003), 45–57.
- [29] M. Bohner, A. Peterson, *Dynamic Equations on Time Scales: In Introduction with Applications*, Birkhäuser, Boston (2001).
- [30] M. Bohner, A. Peterson, eds., *Advanced in Dynamic Equations on Time Scales*, Birkhäuser, Boston (2003).
- [31] H. Bohr, *Almost-Periodic Functions*, Chelsea, New York (1951).
- [32] O. Borůvka, *Lineare Differentialtransformationen 2. Ordnung*, Deutscher Verlag der Wissenschaften, Berlin (1961).
- [33] M. Cecchi, Z. Došlá, M. Marini, *On the dynamics of the generalized Emden–Fowler equations*, Georgian Math. J. **7** (2000), 269–282.
- [34] M. Cecchi, Z. Došlá, M. Marini, *On decaying solutions for functional differential equations with p -Laplacian*, Nonlinear Anal. **47** (2001), 4387–4398.
- [35] M. Cecchi, Z. Došlá, M. Marini, *On the nonoscillatory solutions of differential equations with p -Laplacian*, Adv. Math. Sci. Appl. **11** (2001), 419–436.
- [36] M. Cecchi, Z. Došlá, M. Marini, *Principal solutions and minimal sets of quasilinear differential equations*, Dynam. Systems Appl., to appear.
- [37] M. Cecchi, Z. Došlá, M. Marini, *Half-linear equations and characteristic properties of principal solutions*, (2003), submitted.
- [38] M. Cecchi, M. Marini, G. Villari, *On the monotonicity property for a certain class of second order differential equations*, J. Differential Equations **82** (1) (1989), 15–27.
- [39] M. Cecchi, M. Marini, G. Villari, *Integral criteria for a classification of solutions of linear differential equations*, J. Differential Equations **9** (2) (1992), 381–397.
- [40] M. Cecchi, M. Marini, G. Villari, *On a nonlinear second order differential equation with oscillating coefficient*, Differential Integral Equations **6** (1) (1993), 47–61.
- [41] M. Cecchi, M. Marini, G. Villari, *On some classes of continuable solutions of a nonlinear differential equation*, J. Differential Equations **118** (2) (1995), 403–419.

- [42] T. Chantladze, N. Kandelaki, A. Lomtatidze, *On zeros of solutions of a second order singular half-linear equation*. Mem. Differential Equations Math. Phys. **17** (1999), 127–154.
- [43] T.A. Chanturia, *On singular solutions of nonlinear systems of ordinary differential equations*, Colloq. Math. Soc. J. Bolyai **15** (1975), 107–119.
- [44] T.A. Chanturia *On monotonic solutions of systems of nonlinear differential equations*, Ann. Polon. Math. **37** (1980), 59–70 (in Russian).
- [45] Sh. Chen, Q. Huang, L.H. Erbe, *Bounded and zero-convergent solutions of a class of Stieltjes integro-differential equations*, Proc. Amer. Math. Soc. **113** (1991), 999–1008.
- [46] W.J. Coles, *An oscillation criterion for second order differential equations*, Proc. Amer. Math. Soc. **19** (1969), 775–779.
- [47] M. Cuesta, D. de Figueiredo, J.-P. Gossez, *The beginning of the Fučík spectrum for the p -Laplacian*, J. Differential Equations **159** (1999), 212–238.
- [48] M. Cuesta, D. de Figueiredo, J.-P. Gossez, *A nodal domain property for the p -Laplacian*, C. R. Acad. Sci. Paris, Sér. I **330** (2000), 669–673.
- [49] M. Del Pino, P. Drábek, R. Manásevich, *The Fredholm alternative at the first eigenvalue for the one dimensional p -Laplacian*, J. Differential Equations **151** (1999), 386–419.
- [50] M. Del Pino, R. Manásevich, *Oscillation and nonoscillation for $(|u|^{p-2}u)' + a(t)|u|^{p-2}u = 0$, $p > 1$* , Houston J. Math. **14** (1988), 173–177.
- [51] M. Del Pino, M. Elgueta, R. Manásevich, *Generalizing Hartman's oscillation result for $(|x|^{p-2}x)' + c(t)|x|^{p-2}x = 0$, $p > 1$* , Houston J. Math. **17** (1991), 63–70.
- [52] M. Del Pino, M. Elgueta, R. Manásevich, *A homotopic deformation along p of a Leray–Schauder degree result and existence for $(|u|^{p-2}u)' + f(t, u) = 0$, $u(0) = 0 = u(T)$, $p > 1$* , J. Differential Equations **80** (1989), 1–13.
- [53] M. Del Pino, R. Manásevich, *Multiple solutions for the p -Laplacian under global nonresonance*, Proc. Amer. Math. Soc. **112** (1991), 131–138.
- [54] J.I. Díaz, *Nonlinear Partial Differential Equations and Free Boundaries*, Elliptic Equations, Vol. I, Pitman, London (1985).
- [55] O. Došlý, *The multiplicity criteria for zero points of second order differential equations*, Math. Slovaca **42** (1992), 183–192.
- [56] O. Došlý, *Conjugacy criteria for second order differential equations*, Rocky Mountain J. Math. **23** (1993), 849–861.
- [57] O. Došlý, *Oscillation criteria for higher order Sturm–Liouville difference equations*, J. Difference Equations Appl. **4** (1998), 425–450.
- [58] O. Došlý, *Oscillation criteria for half-linear second order differential equations*, Hiroshima Math. J. **28** (1998), 507–521.
- [59] O. Došlý, *A remark on conjugacy of half-linear second order differential equations*, Math. Slovaca **50** (2000), 67–79.
- [60] O. Došlý, *Methods of oscillation theory of half-linear second order differential equations*, Czechoslovak Math. J. **50** (125) (2000), 657–671.
- [61] O. Došlý, *Half-linear oscillation theory*, Stud. Univ. Žilina Math.-Phys. Ser. **13** (2001), 65–73.
- [62] O. Došlý, *The Picone identity for a class of partial differential equations*, Math. Bohem. **127** (2002), 581–589.
- [63] O. Došlý, *Qualitative theory of half-linear second order differential equations*, Math. Bohem. **127** (2002), 181–195.
- [64] O. Došlý, *Half-linear second order differential equations: oscillation theory and principal solution*, Stud. Univ. Žilina Math.-Phys. Ser. **17** (2003), 69–78.
- [65] O. Došlý, Á. Elbert, *Conjugacy of half-linear second-order differential equations*, Proc. Roy. Soc. Edinburgh A **130** (2000), 517–525.
- [66] O. Došlý, Á. Elbert, *Integral characterization of principal solution of half-linear differential equations*, Studia Sci. Math. Hungar. **36** (2000), 455–469.
- [67] O. Došlý, J. Jaroš, *Singular version of Leighton's comparison theorem for forced quasilinear second order differential equations*, Arch. Math. (Brno) **39** (2003), 335–349.
- [68] O. Došlý, A. Lomtatidze, *Disconjugacy and disfocality criteria for singular half-linear second order differential equations*, Ann. Polon. Math. **72** (1999), 273–284.

- [69] O. Došlý, A. Lomtatidze, *Oscillation and nonoscillation criteria for half-linear second order differential equations*, submitted.
- [70] O. Došlý, R. Mařík, *Nonexistence of positive solutions of PDE's with p -Laplacian*, Acta Math. Hungar. **90** (2001), 89–107.
- [71] O. Došlý, P. Řehák, *Nonoscillation criteria for half-linear second-order difference equations*, Comput. Math. Appl. **42** (2001), 453–464.
- [72] O. Došlý, J. Řezníčková, *Regular half-linear second order differential equations*, Arch. Math. **39** (2003), 233–245.
- [73] P. Drábek, *Fredholm alternative for the p -Laplacian: yes or no?*, Function Spaces, Differential Operators and Nonlinear Analysis, Proceedings of the Conference FSDONA-99 (Syöte, Finland, June 10–16, 1999), Mustonen, Vesa, et al., eds., Mathematical Institute of the Academy of Sciences of the Czech Republic, Prague (2000), 57–64.
- [74] P. Drábek, *Solvability and Bifurcations of Nonlinear Equations*, Research Notes in Mathematics, Vol. 264, Longman, Harlow (1992).
- [75] P. Drábek, *Geometry of energy functional and the Fredholm alternative for the p -Laplacian*, Electron. J. Differential Equations **2002** (08) (2002) 103–120.
- [76] P. Drábek, P. Girg, R. Manásevich, *Generic Fredholm results for the one-dimensional p -Laplacian*, Nonlinear Differential Equations Appl. **8** (2001), 285–298.
- [77] P. Drábek, P. Girg, P. Takáč, M. Ulm, *The Fredholm alternative for p -Laplacian: bifurcation from infinity, existence and multiplicity*, submitted.
- [78] P. Drábek, R. Manásevich, *On the closed solution to some nonhomogeneous eigenvalue problems with p -Laplacian*, Differential Integral Equations **12** (1999), 773–788.
- [79] P. Drábek, M. Otani, *Global bifurcation result for the p -biharmonic operator*, Electron. J. Differential Equations **2001** (48) (2001), 1–19.
- [80] P. Drábek, B. Robinson, *Resonance problems for the one-dimensional p -Laplacian*, Proc. Amer. Math. Soc. **128** (1999), 755–765.
- [81] P. Drábek, B. Robinson, *On the generalization of the Courant nodal domain theorem*, J. Differential Equations **181** (2002), 58–71.
- [82] P. Drábek, P. Takáč, *A counterexample to the Fredholm alternative for the p -Laplacian*, Proc. Amer. Math. Soc. **127** (1999), 1079–1087.
- [83] D.R. Dunninger, *A Sturm comparison theorem for some degenerate quasilinear elliptic operators*, Boll. UMIA **9** (1995), 117–121.
- [84] W. Eberhard, Á. Elbert, *On the eigenvalues of half-linear boundary value problems*, Math. Nachr. **183** (1997), 55–72.
- [85] Á. Elbert, *A half-linear second order differential equation*, Colloq. Math. Soc. János Bolyai **30** (1979), 158–180.
- [86] Á. Elbert, *The Wronskian and the half-linear differential equations*, Studia Sci. Math. Hungar. **15** (1980), 101–105.
- [87] Á. Elbert, *Oscillation and nonoscillation theorems for some non-linear ordinary differential equations*, Lecture Notes in Math., Vol. 964 (1982), 187–212.
- [88] Á. Elbert, *Asymptotic behaviour of autonomous half-linear differential systems on the plane*, Studia Sci. Math. Hungar. **19** (1984), 447–464.
- [89] Á. Elbert, *On the half-linear second order differential equations*, Acta Math. Hungar. **49** (1987), 487–508.
- [90] Á. Elbert, T. Kusano, *Principal solutions of nonoscillatory half-linear differential equations*, Adv. Math. Sci. Appl. **18** (1998), 745–759.
- [91] Á. Elbert, T. Kusano, M. Naito, *On the number of zeros of nonoscillatory solutions to second order half-linear differential equations*, Ann. Univ. Sci. Budapest **42** (1999), 101–131.
- [92] Á. Elbert, T. Kusano, M. Naito, *Counting the number of zeros of nonoscillatory solutions of second order half-linear differential equations*, Proceedings of the International Scientific Conference of Mathematics (Žilina, Slovakia, June 30–July 3, 1998), P. Marušiak, et al., eds., Žilina University Publisher (1999), 133–140.
- [93] Á. Elbert, T. Kusano, T. Tanigawa, *An oscillatory half-linear differential equation*, Arch. Math. **33** (1997), 355–361.

- [94] Á. Elbert, A. Schneider, *Perturbations of the half-linear Euler differential equation*, Results Math. **37** (2000), 56–83.
- [95] R. Emden, *Gaskugeln, Anwendungen der mechanischen Warmentheorie auf Kosmologie und meteorologische Probleme*, Leipzig (1907).
- [96] L. Erbe, *Oscillation criteria for second order nonlinear delay equations*, Canad. Math. Bull. **16** (1973), 49–56.
- [97] L. Erbe, S. Hilger, *Sturmian theory on measure chains*, Differential Equations Dynam. Systems **1** (1993), 223–244.
- [98] V.M. Evtuchov, *On conditions for nonoscillation of a nonlinear second order differential equation*, Mat. Zametki **67** (2000), 201–210.
- [99] X. Fan, W.-T. Li, C. Zhong, *A Classification scheme for positive solutions of second order iterative differential equations*, Electron. J. Differential Equations **2002** (25) (2000), 1–14.
- [100] J. Fleckinger, J.-P. Gossez, P. Takáč, *Existence, nonexistence et principe de l'antimaximum pour le p -Laplacian*, C. R. Acad. Sci. Paris, Sér. I **321**, 731–734.
- [101] J. Fleckinger, J. Hernández, P. Takáč, F. de Thélin, *Uniqueness and positivity for solutions of equations with p -Laplacian*, Proc. Conference on Reaction-Diffusion Equations (Trieste, Italy, October 1995), Marcel Dekker, New York–Basel (1997).
- [102] R.H. Fowler, *The solutions of Emden's and similar differential equations*, Month. Not. Roy. Astron. Soc. **91** (1930), 63–91.
- [103] S. Fučík, J. Nečas, J. Souček, V. Souček, *Spectral Analysis of Nonlinear Operators*, Lecture Notes in Math., Vol. 346, Springer-Verlag, New York–Berlin–Heidelberg (1973).
- [104] M.R. Grossinho, P. Omari, *A multiplicity result for a class of quasilinear elliptic and parabolic problems*, Electron. J. Differential Equations **1997** (08) (1997), 1–16.
- [105] G.H. Hardy, J.E. Littlewood, G. Pólya, *Inequalities*, Cambridge (1934).
- [106] P. Hartman, *Ordinary Differential Equations*, Wiley, New York–London–Sydney (1964).
- [107] L. Hatvani, *On stability properties of solutions of second order differential equations*, Proc. Colloq. Qual. Theory Differ. Equ. Szeged, Electron. J. Qual. Theory Differ. Equ. **2000**, Supl. 6 p.
- [108] L. Hatvani, *On the existence of small solutions to linear second order differential equations with step function coefficients*, Dynam. Contin., Discrete Impuls. Systems **4** (1998), 321–330.
- [109] S. Hilger, *Analysis on measure chains—a unified approach to continuous and discrete calculus*, Results Math. **18** (1990), 18–56.
- [110] E. Hille, *Lectures on Ordinary Differential Equations*, Addison–Wesley, Reading (1969).
- [111] H.L. Hong, W.Ch. Lian, C.C. Yeh, *The oscillation of half-linear differential equations with oscillatory coefficient*, Math. Comput. Modelling **24** (1996), 77–86.
- [112] H. Hoshino, R. Imabayashi, T. Kusano, T. Tanigawa, *On second order half-linear oscillations*, Adv. Math. Sci. Appl. **8** (1998), 199–216.
- [113] Ch. Huang, *Oscillation and nonoscillation for second order linear differential equations*, J. Math. Anal. Appl. **210** (1997), 712–713.
- [114] Y.X. Huang, *Eigenvalues of the p -Laplacian with indefinite weight*, Comment. Math. Univ. Carolinae **36** (1995), 519–527.
- [115] J. Jaroš, T. Kusano, *A Picone type identity for half-linear differential equations*, Acta Math. Univ. Comenianae **68** (1999), 137–151.
- [116] J. Jaroš, T. Kusano, *Generalized Picone's formula and forced oscillations in quasilinear differential equations of the second order*, Arch. Math. (Brno) **38** (2002), 53–59.
- [117] J. Jaroš, T. Kusano, T. Tanigawa, *Nonoscillation theory for second order half-linear differential equations in the framework of regular variation*, Results Math. **43** (2003), 129–149.
- [118] J. Jaroš, T. Kusano, N. Yoshida, *A Picone-type identity and Sturmian comparison and oscillation theorems for a class of half-linear partial differential equations of the second order*, Nonlinear Anal. TMA **40** (2000), 381–395.
- [119] J. Jianchu, *Oscillation and nonoscillation for the second order quasilinear differential equations*, Math. Sci. Res. Hot-Line **4** (2000), 39–47.
- [120] W. Jingfa, *Oscillation and nonoscillation theorems for a class of second order quasilinear functional differential equations*, Hiroshima Math. J. **27** (1997), 449–466.
- [121] W. Jingfa, *On second order quasilinear oscillations*, Funkcial. Ekvac. **41** (1998), 25–54.

- [122] N. Kandelaki, A. Lomtadize, D. Ugulava, *On the oscillation and nonoscillation of a second order half-linear differential equation*, Georgian Math. J. **7** (2000), 329–346.
- [123] J. Karsai, *On the existence of a solution tending to zero of nonlinear differential equations (a nonlinear extension of a theorem of Milloux, Prodi, Trevisan and Hartman)*, Dynamic Systems Appl. **6** (1997), 429–440.
- [124] W.G. Kelley, A. Peterson, *Difference Equations: An Introduction with Applications*, Academic Press, San Diego (1991).
- [125] I. Kiguradze, *Asymptotic properties of solutions of a nonlinear differential equation of Emden–Fowler type*, Izvestiya Akad. Nauk SSSR. Ser. Mat. **29** (1965), 965–986 (in Russian).
- [126] I. Kiguradze, *Some Singular Boundary Value Problems for Ordinary Differential Equations*, Tbilisi University Press, Tbilisi (1975) (in Russian).
- [127] I.T. Kiguradze, T.A. Chanturia, *Asymptotic Properties of Solutions of Nonautonomous Ordinary Differential Equations*, Kluwer Academic, Dordrecht (1993).
- [128] I. Kiguradze, G. Kvinikadze, *On strongly increasing solutions of nonlinear ordinary differential equations*, Ann. Mat. Pura Appl. **130** (1982), 67–87.
- [129] J. Kiomura, T. Kusano, M. Naito, *Positive solutions of second order quasilinear differential equations with general nonlinearities*, Studia Sci. Math. Hungar. **35** (1999), 39–51.
- [130] Q. Kong, *Oscillation criteria for second order half-linear differential equations*, Differential Equations with Applications in Biology. Proceedings of the International Conference (Halifax, Canada, July 25–29, 1997), Ruan, Shigui, et al., eds., Amer. Math. Soc., Providence, RI, Fields Inst. Commun. **21** (1999), 317–323.
- [131] A. Kufner, L.-E. Persson, *Weighted Inequalities of Hardy-Type*, World Scientific, Singapore (2003).
- [132] T. Kusano, M. Kitano, *On a class of second order quasilinear ordinary differential equations*, Hiroshima Math. J. **25** (1995), 321–355.
- [133] T. Kusano, M. Naito, *Sturm–Liouville eigenvalue problems for half-linear ordinary differential equations*, Rocky Mountain J. Math. **31** (2001), 1039–1054.
- [134] T. Kusano, M. Naito, *On the number of zeros of nonoscillatory solutions of half-linear ordinary differential equations involving a parameter*, Trans. Amer. Math. Soc. **324** (2002), 4751–4767.
- [135] T. Kusano, Y. Naito, *Oscillation and nonoscillation criteria for second order quasilinear differential equations*, Acta Math. Hungar. **76** (1997), 81–99.
- [136] T. Kusano, Y. Naito, A. Ogata, *Strong oscillation and nonoscillation of quasilinear differential equations of second order*, Differential Equations Dynamic Systems **2** (1994), 1–10.
- [137] T. Kusano, M. Naito, T. Tanigawa, *Second order half-linear eigenvalue problem*, Fukuoka Univ. Sci. Rep. **27** (1999), 1–7.
- [138] T. Kusano, A. Otaga, *Existence and asymptotic behavior of positive solutions of second order quasilinear differential equations*, Funkcial. Ekvac. **37** (1994), 345–361.
- [139] T. Kusano, A. Otaga, *On oscillation of functional differential equations with forcing term*, Fukuoka Univ. Sci. Rep. **29** (1999), 225–229.
- [140] T. Kusano, A. Otaga, H. Usami, *Oscillation theory for a class of second order quasilinear ordinary differential equations with application to partial differential equations*, Jpn. J. Math. **19** (1993), 131–147.
- [141] T. Kusano, N. Yoshida, *Nonoscillation theorems for a class of quasilinear differential equations of second order*, J. Math. Anal. Appl. **189** (1995), 115–127.
- [142] T. Kusano, J. Wang, *Oscillation properties of half-linear differential equations of the second order*, Hiroshima Math. J. **25** (1995), 371–385.
- [143] G. Kvinikadze, *On strongly increasing solutions of system of nonlinear ordinary differential equations*, Trudy Inst. Prikl. Mat. I. Vekua **37** (1990), 41–49.
- [144] J. Luo, L. Debnath, *Oscillation criteria for second order functional differential equations*, Comput. Math. Appl. **44** (2002), 731–739.
- [145] E.M. Landesman, A.C. Lazer, *Nonlinear perturbations of linear elliptic boundary value problems at resonance*, J. Math. Mech. **19** (1970), 609–623.
- [146] W. Leighton, *The detection of oscillation of solutions of a second order linear differential equations*, Duke J. Math. **17** (1950), 57–62.
- [147] W. Leighton, *Comparison theorems for linear differential equations of second order*, Proc. Amer. Math. Soc. **13** (1962) 603–610.

- [148] W. Leighton, M. Morse, *Singular quadratic functionals*, Trans. Amer. Math. Soc. **40** (1936), 252–286.
- [149] H.J. Li, *Oscillation criteria for second order linear differential equations*, J. Math. Anal. Appl. **194** (1995), 217–234.
- [150] H.J. Li, C.C. Yeh, *An integral criterion for oscillation of nonlinear differential equations*, Math. Japon. **41** (1995), 185–188.
- [151] H.J. Li, C.C. Yeh, *An oscillation criterion of almost-periodic Sturm–Liouville equations*, Rocky Mountain J. Math. **25** (1995), 1417–1429.
- [152] H.J. Li, C.C. Yeh, *Oscillations criteria for half-linear second order differential equations*, Hiroshima Math. J. **25** (1995), 571–583.
- [153] H.J. Li, C.C. Yeh, *Oscillations of half-linear second order differential equations*, Hiroshima Math. J. **25** (1995), 585–594.
- [154] H.J. Li, C.C. Yeh, *Sturmian comparison theorem for half-linear second order differential equations*, Proc. Roy. Soc. Edinburgh A **125** (1995), 1193–1204.
- [155] H.J. Li, C.C. Yeh, *Nonoscillation of half-linear differential equations*, Publ. Math. (Debrecen) **49** (1996), 327–334.
- [156] W.-T. Li, *Classification schemes for positive solutions of nonlinear differential systems*, Math. Comput. Modelling **36** (2002) 411–418.
- [157] W.-T. Li, S.S. Cheng, *Limiting behavior of nonoscillatory solutions of a pair of coupled nonlinear differential equations*, Proc. Edinburgh Math. Soc. **43** (2000), 457–473.
- [158] W.-T. Li, S.S. Cheng, *An oscillation criterion for nonhomogeneous half-linear differential equations*, Appl. Math. Lett. **15** (2002), 259–263.
- [159] P. Lindqvist, *Note on a nonlinear eigenvalue problem*, Rocky Mountain J. Math. **23** (1993), 281–288.
- [160] P. Lindqvist, *On the equation $\operatorname{div}(|\nabla u|^{p-2}\nabla u) + \lambda|u|^{p-2}u = 0$* , Proc. Amer. Math. Soc. **109** (1990), 157–164.
- [161] P. Lindqvist, *Some remarkable sine and cosine functions*, Ricerche Math. **14** (1995), 269–280.
- [162] A. Lomtatidze, *Oscillation and nonoscillation of Emden–Fowler type equation of second order*, Arch. Math. **32** (1996), 181–193.
- [163] J.V. Manojlović, *Oscillation criteria for second-order half-linear differential equations*, Math. Comput. Modelling **30** (1999), 109–119.
- [164] R. Manásevich, J. Mawhin, *The spectrum of p -Laplacian systems with various boundary conditions*, Adv. Differential Equations **5** (2000), 1289–1318.
- [165] R. Manásevich, F.I. Njoku, F. Zanolin, *Positive solutions for the one-dimensional p -Laplacian*, Differential Integral Equations **8** (1995), 213–222.
- [166] R. Manásevich, S. Sedziwy, *p -Laplacian and Lienard-type equation*, Rocky Mountain J. Math. **27** (1997), 611–617.
- [167] R. Manásevich, P. Takáč, *On the Fredholm alternative for the p -Laplacian*, Proc. London Math. Soc., Ser. III **84** (2002), 324–342.
- [168] R. Manásevich, F. Zanolin, *Time-mappings and multiplicity of solutions for one-dimensional p -Laplacian*, Nonlinear Anal. TMA **21** (1993), 269–291.
- [169] R. Mařík, *Nonnegativity of functionals corresponding to the second order half-linear differential equation*, Arch. Math. (Brno) **35** (1999), 155–164.
- [170] R. Mařík, *Focal points of half-linear differential equations*, Differential Equations Dynamic Systems **8** (2000), 111–124.
- [171] R. Mařík, *A half-linear differential equation corresponding to variational problem*, Nonlinear Anal. A **45** (2001), 203–211.
- [172] M. Marini, *Monotone solutions of a class of second order nonlinear differential equation*, Nonlinear Anal. TMA **8** (1984), 261–271.
- [173] M. Marini, *On nonoscillatory solutions of a second order nonlinear differential equation*, Boll. UMI, Ser. VI **3C** (1) (1984), 189–202.
- [174] M. Marini, P. Zezza, *On the asymptotic behavior of the solutions of second order linear differential equations*, J. Differential Equations **28** (1978), 1–17.
- [175] H. Milloux, *Sur l'équation différentielle $x'' + A(t)x = 0$* , Prace Mat. **41** (1934), 39–53.
- [176] J.D. Mirzov, *On some analogs of Sturm's and Kneser's theorems for nonlinear systems*, J. Math. Anal. Appl. **53** (1976), 418–425.

- [177] J.D. Mirzov, *Principal and nonprincipal solutions of a nonoscillatory system*, Tbiliss. Gos. Univ. Inst. Prikl. Mat. Trudy **31** (1988), 100–117.
- [178] J.D. Mirzov, *Asymptotic Properties of Nonlinear Systems of Nonautonomous Ordinary Differential Equations*, Majkop (1993) (in Russian).
- [179] S. Matucci, *On asymptotic decaying solutions for a class of second order differential equations*, Arch. Math. (Brno) **35** (1999), 275–284.
- [180] M. Mizukami, M. Naito, H. Usami, *Asymptotic behavior of solutions of a class of second order quasilinear ordinary differential equations*, Hiroshima Math. J. **32** (2002), 51–78.
- [181] Y. Nagabuchi, M. Yamamoto, *On the monotonicity of solutions for a class of nonlinear differential equations of second order*, Math. Japonica **37** (1992), 665–673.
- [182] M. Naito, Y. Naito, H. Usami, *Oscillation theory for semilinear elliptic equations with arbitrary nonlinearities*, Funkcial. Ekvac. **40** (1997), 41–55.
- [183] F. Neuman, *Global Properties of Linear Differential Equations*, Kluwer Academic, Dordrecht (1991).
- [184] J. Ohriska, *Oscillation of second order delay and ordinary differential equation*, Czech. Math. J. **34** (1984), 107–112.
- [185] C. Olech, Z. Opial, T. Ważewski, *Sur le probleme d'oscillation des integrales de l'equation $y'' + g(t)y = 0$* , Bull. Acad. Polon. Sci. **5** (1957), 621–626.
- [186] M. Otani, *A remark on certain nonlinear elliptic equations*, Proc. Fac. Sci. Tokai Univ. **19** (1984), 23–28.
- [187] M. Otani, *On certain second order ordinary differential equations associated with Sobolev–Poincare-type inequalities*, Nonlinear Anal. Appl. **8** (1984), 1255–1270.
- [188] S. Peña, *Conjugacy criteria for half-linear differential equations*, Arch. Math. (Brno) **35** (1999), 1–11.
- [189] Ch. Philos, *Oscillation theorems for linear differential equations of second order*, Arch. Math. (Basel) **53** (1989), 493–492.
- [190] M. Picone, *Sui valori eccezionali di un parametro da cui dipende un'equazione differenziale lineare del secondo ordine*, Ann. Scuola Norm. Sup. Pisa **11** (1910), 1–141.
- [191] M. Piros, *On the solutions of a half-linear differential equation*, Studia Sci. Math. Hungar. **19** (1984), 193–211.
- [192] M. Ráb, *Kriterien für oscillation der Lösungen der Differentialgleichung $[p(x)y']' + q(x)y = 0$* , Čas. Pěst. Mat. **84** (1957), 335–370.
- [193] V.A. Rabtsevich, *On strongly increasing solutions of arbitrary order Emden–Fowler system*, Differential'nye Uravneniya **34** (1998), 222–227 (in Russian).
- [194] P. Řehák, *Hartman–Wintner lemma, oscillation and conjugacy criteria for half-linear difference equations*, J. Math. Anal. Appl. **252** (2000), 813–827.
- [195] P. Řehák, *Oscillatory properties of second order half-linear difference equations*, Czechoslovak. Math. J. **51** (126) (2001), 303–321.
- [196] P. Řehák, *Generalized discrete Riccati equation and oscillation of half-linear difference equations*, Math. Comput. Modelling **34** (2001), 257–269.
- [197] P. Řehák, *Oscillation and nonoscillation criteria for second order linear difference equations*, Fasc. Math. **31** (2001), 71–89.
- [198] P. Řehák, *Oscillation criteria for second order half-linear difference equations*, J. Difference Equations Appl. **7** (2001), 483–505.
- [199] P. Řehák, *Comparison theorems and strong oscillation in the half-linear discrete oscillation theory*, Rocky Mountain J. Math. **33** (2003), 333–352.
- [200] P. Řehák, *Half-linear dynamic equations on time scales: IVP and oscillatory properties*, J. Nonlinear Funct. Anal. Appl. **7** (2002), 361–403.
- [201] P. Řehák, *On certain comparison theorems for half-linear dynamic equations on time scales*, Abstracts Appl. Anal., to appear.
- [202] W. Reichel, W. Walter, *Radial solutions of equations and inequalities involving the p -Laplacian*, J. Inequal. Appl. **1** (1997), 47–91.
- [203] R.T. Rockafeller, *Convex Analysis*, Princeton (1970).
- [204] Y.V. Rogovchenko, *Note on: "Oscillation criteria for second order linear differential equations"*, J. Math. Anal. Appl. **203** (1996), 560–563.
- [205] S.P. Rogovchenko, Y.V. Rogovchenko, *Asymptotic behavior of certain second order differential equations*, Dynamic Systems Appl. **10** (2001), 185–200.

- [206] G. Sansone, *Equazioni differenziali nel campo reale I, II*, Zanichelli, Bologna (1949).
- [207] M. Struwe, *Variational Methods; Applications to Nonlinear Partial Differential Equations and Hamiltonian Systems*, Springer-Verlag, New York (1990).
- [208] C.A. Swanson, *Comparison and Oscillation Theory of Linear Differential Equations*, Academic Press, New York–London (1968).
- [209] G. Talenti, *Best constant in Sobolev inequality*, Ann. Mat. Pura Appl. **110** (1976), 353–272.
- [210] T. Tanigawa, *Existence and asymptotic behavior of positive solutions of second order quasilinear differential equations*, Adv. Math. Sci. Appl. **9** (1999), 907–938.
- [211] L.H. Thomas, *The calculation of atomic fields*, Proc. Cambridge Philos. Soc. **23** (1927), 542–548.
- [212] F.J. Tipler, *General relativity and conjugate differential equations*, J. Differential Equations **30** (1978), 165–174.
- [213] N. Trudinger, *On Harnack type inequalities and their application to quasilinear elliptic equations*, Comm. Pure Appl. Math. **20** (1967), 721–747.
- [214] Ch. de Vallée Poussin, *Sur l'équation différentielle linéaire du second order. Détermination d'une intégrale par deux valeurs assignés. Extension aux équations d'ordre n* , J. Math. Pures Appl. **8** (1929), 125–144.
- [215] J.S. Wong, *Oscillation criteria for forced second order linear differential equation*, J. Math. Anal. Appl. **231** (1999), 235–240.
- [216] Q.-R. Wang, *Oscillation and asymptotics for second-order half-linear differential equations*, Appl. Math. Comput. **122** (2001), 253–266.
- [217] D. Willet, *On the oscillatory behavior of the solutions of second order differential equations*, Ann. Polon. Math. **21** (1969), 175–194.
- [218] P.J.Y. Wong, R.P. Agarwal, *The oscillation and asymptotically monotone solutions of second-order quasilinear differential equations*, Appl. Math. Comput. **79** (1996), 207–237.
- [219] P.J.Y. Wong, R.P. Agarwal, *Oscillation criteria for half-linear differential equations*, Adv. Math. Sci. Appl. **9** (1999), 649–663.
- [220] J. Yan, *A note on an oscillation criterion for an equation with damping term*, Proc. Amer. Math. Soc. **90** (1984), 277–280.
- [221] J. Yan, *Oscillation theorems for second order linear differential equations with damping*, Proc. Amer. Math. Soc. **98** (1986), 276–282.
- [222] X. Yang, *Oscillation results for second order half-linear differential equations*, Math. Comput. Modelling **36** (2002), 503–507.
- [223] X. Yang, *Positive solutions for the one-dimensional p -Laplacian*, Math. Comput. Modelling **35** (2002), 129–135.
- [224] X. Yang, *On inequalities of Lyapunov type*, Appl. Math. Comput. **134** (2003), 293–300.
- [225] X. Yang, *Nonoscillation criteria for second-order nonlinear differential equations*, Appl. Math. Comput. **131** (2002), 125–131.
- [226] C.C. Yeh, *Levin's comparison theorems for second order nonlinear differential equations and inequalities*, Math. Jpn. **36** (1991), 703–710.
- [227] G. Zhang, S.S. Cheng, *On connected half-linear differential equations*, Demonstratio Math. **32** (1999), 345–354.

This Page Intentionally Left Blank

CHAPTER 4

Radial Solutions of Quasilinear Elliptic Differential Equations

Jon Jacobsen

Department of Mathematics, Harvey Mudd College, Claremont, CA 91711, USA
E-mail: jacobsen@math.hmc.edu

Klaus Schmitt

Department of Mathematics, 155 South 1400 East, University of Utah, Salt Lake City, UT 84112-0090, USA
E-mail: schmitt@math.utah.edu

Contents

1. Introduction	361
2. Boundary value problems on a ball	363
2.1. Introduction	363
2.2. The case when $f(0) = 0$	364
2.3. The case when $f(0) < 0$	387
2.4. The case when $f(0) > 0$	389
3. Problems on annular domains	392
3.1. Fixed point formulation	393
3.2. Existence results	396
3.3. Positone problems	400
4. The Liouville–Gelfand equation — A case study	405
4.1. Introduction	405
4.2. Solution set for the semilinear case	406
4.3. Solution set for the quasilinear case	409
5. Rellich–Pohozaev identities	412
5.1. More general equations	414
5.2. Critical dimensions	418
6. Problems linear at infinity	419
6.1. Landesman–Lazer results	421
6.2. Nonlinear terms which oscillate	422
7. Symmetry breaking	424
8. Whole space problems	427
References	431

HANDBOOK OF DIFFERENTIAL EQUATIONS

Ordinary Differential Equations, volume 1

Edited by A. Cañada, P. Drábek and A. Fonda

© 2004 Elsevier B.V. All rights reserved

Abstract

This paper constitutes a short survey of the subject of radial solutions for quasilinear elliptic partial differential equations where the underlying domain is either a ball, an annular region, the exterior of a ball, or the whole space. In case the dependence of the equation on the independent variable is only in the radial direction, special solutions of such equations may be sought which depend only on the radial variable and as such are solutions of a boundary value problem for an associated nonlinear ordinary differential equation.

1. Introduction

In this paper we provide a survey of several results concerning radial solutions of quasilinear partial differential equations where the independent variable is a spatial variable varying over a domain with radial symmetry, such as a ball centered at the origin, an annular domain determined by concentric spheres centered at the origin, an exterior domain exterior to a ball, or the whole space. If the equation at hand also has the property that the dependence upon the independent variable is radial, then special radial solutions of the problem at hand may be sought and it is often the case that certain solutions having special properties, in fact, must be radial solutions.

The situation is well illustrated by the very classical problem of finding the radial eigenvalues and eigenfunctions of the Laplace operator subject to zero Dirichlet boundary conditions on the unit disk in the plane. Another illustration is the following classical Liouville–Gelfand problem which is concerned with the existence of positive solutions of the equation

$$\begin{cases} \Delta u + \lambda e^u = 0, & x \in \Omega, \\ u = 0, & x \in \partial\Omega, \end{cases} \quad (1.1)$$

where $\lambda > 0$ and Ω is a bounded domain in \mathbb{R}^N . If it is the case that $\Omega = \{x \in \mathbb{R}^N : |x| < 1\} := B_1(0)$, then it is reasonable to ask whether Equation (1.1) has solutions which only depend upon the radial variable. It follows from the maximum principle for elliptic equations that solutions of (1.1) can only assume positive values in the interior of the domain and then it follows by the classical result of Gidas, Ni, and Nirenberg [50] that all solutions of (1.1) are radially symmetric and (1.1) is equivalent to the ordinary differential equation's boundary value problem

$$\begin{cases} u'' + \frac{N-1}{r}u' + \lambda e^u = 0, & r \in (0, 1), \\ u'(0) = u(1) = 0, \end{cases} \quad (1.2)$$

for the profile $u(r) = u(|x|)$. Note that the originally discrete parameter N is now allowed to vary continuously. The results of [50] are valid for much more general situations and it follows that if $f : \mathbb{R} \rightarrow \mathbb{R}$ is a suitably smooth function (e.g., Lipschitz continuous), then any positive solution of

$$\begin{cases} \Delta u + f(u) = 0, & x \in \Omega, \\ u = 0, & x \in \partial\Omega, \end{cases} \quad (1.3)$$

with Ω a ball, must be radially symmetric about the center of the ball and similar results hold for the case that Ω is the whole space or a suitable exterior domain. It, on the other hand fails to hold for the case that Ω is an annular domain, in which case it often may happen that radial solutions undergo symmetry breaking bifurcations (some such results will be discussed in this paper).

If it is the case that

$$\Omega = \{x \in \mathbb{R}^N : 0 < a < |x| < b\},$$

then radial solutions of (1.3) are solutions of the boundary value problem

$$\begin{cases} u'' + \frac{N-1}{r}u' + f(u) = 0, & r \in (a, b), \\ u(a) = u(b) = 0. \end{cases} \tag{1.4}$$

For $N = 1$ these problems are amenable to reduction of order methods, and hence may be explicitly solved. For other values of N , this is, of course, no longer the case in general and other methods must be employed to study the solution structure of a given equation. We shall give a detailed account of problems related to (1.1) and related equations, a subject that dates back to Liouville in 1853 [71]. In 1914 Bratu [15] found an explicit solution to (1.2) when $N = 2$. Numerical progress for (1.2) when $N = 3$ was made by Frank-Kamenetskii (see [40]) in his study of thermal ignition problems. Further progress for $N = 3$ was made by Chandrasekhar [20, IV: §22–27], where (1.2) appears as a model for the temperature distribution of an isothermal gas sphere in gravitational equilibrium. Gelfand [49] built upon Frank-Kamenetskii’s work when $N = 3$ and used Emden’s transformation to prove the existence of a value of λ for which (1.2) has infinitely many non-trivial solutions.

In 1973 Joseph and Lundgren [61] completely characterized the solution structure of (1.2) for all N and hence, because of [50] also of the corresponding problem (1.1) in the case the domain is a ball. Other related examples arise from a larger class of partial differential operators, for example the work of Clément, de Figueiredo, and Mitidieri [22], Azorero and Alonso [44], Jacobsen [57], and Jacobsen and Schmitt [59], who consider existence and multiplicity results for the model equations

$$\begin{cases} \Delta_p u + \lambda e^u = 0, & x \in \Omega, \\ u = 0, & x \in \partial\Omega, \end{cases} \tag{1.5}$$

where $\Delta_p = \operatorname{div}(|\nabla u|^{p-2}\nabla u)$ is the p -Laplace operator [56,74] and

$$\begin{cases} S_k(D^2u) + \lambda e^u = 0, & x \in \Omega, \\ u = 0, & x \in \partial\Omega, \end{cases} \tag{1.6}$$

where $S_k(D^2u)$ is the k -Hessian operator [108], defined as the sum of all principal $k \times k$ minors of the Hessian matrix D^2u . For instance $S_1(D^2u) = \Delta u$ and $S_N(D^2u) = \det D^2u$, the Monge–Ampère operator.

Note that both equations are extensions of (1.1). In particular, the results of Joseph and Lundgren explain the radial case of (1.5) for $p = 2$ and of (1.6) when $k = 1$. In [22], the authors consider (among other topics) the radial case of both (1.5) for $p = N$ and (1.6) for $N = 2k$.

All of the above problems are simply special cases of the more general family of problems

$$\begin{cases} r^{-\gamma} (r^\alpha |u'|^\beta u')' + f(\lambda, u) = 0, & r \in (0, 1), \\ u > 0, & r \in (0, 1), \\ u'(0) = u(1) = 0, \end{cases} \tag{1.7}$$

or

$$\begin{cases} r^{-\gamma} (r^\alpha |u'|^\beta u')' + f(\lambda, u) = 0, & r \in (a, b), \\ u > 0, & r \in (a, b), \\ u(a) = u(b) = 0, \end{cases} \tag{1.8}$$

where certain inequalities are to be imposed on the parameters involved in the equation. Here $'$ denotes differentiation with respect to r . For instance, if $\Omega = B_1(0)$ is the unit ball, then Equation (1.7) with $f(\lambda, u) = \lambda e^u$ arises from (1.5) and (1.6) as a consequence of a priori symmetry results (see [35] for (1.6) and [7] for (1.5)). Similar problems may be posed also for exterior domain and whole space problems.

Much work has also been devoted to boundary value problems and other qualitative studies for more general differential operators of the form

$$r^{-\gamma} (r^\alpha \phi(u'))' + f(\lambda, u) = 0, \tag{1.9}$$

where $\phi: \mathbb{R} \rightarrow \mathbb{R}$ is an increasing homeomorphism of \mathbb{R} , with $\phi(0) = 0$. Such problems arise in a very natural way in diffusion problems where diffusion is governed by rapidly growing terms. We shall survey some such problems below.

In most of the discussion to follow the parameter α is taken to equal the parameter γ and is denoted by $N - 1$, to indicate the partial differential equation origin of the problem, where N denotes the dimension of the underlying domain. In the discussion, however, $N - 1$ may simply denote a nonnegative parameter. The equations stated above also may depend on other parameters, denoted by λ , which dependence may be in a linear or nonlinear fashion, thus this parameter may occur as a multiplicative factor or simply as a variable in the function evaluation. Should this parameter play no role in the result at hand, we simply shall suppress the dependence.

The paper is organized as follows: We first discuss boundary value problems on a ball related to the differential operator (1.9) and rely mainly on the recent work in [45–47,54, 53]. We then proceed to discuss problems on annular domains based on some work in [9,10, 25,30,29,74]. Next, we present a detailed discussion of Gelfand type problems. Following the Gelfand case study we return to general theory and present a range of related topics including some classical oscillation and nonoscillation theorems, problems for which radial solutions can undergo symmetry breaking bifurcations (relying on work in [67,68,80–82]), and problems concerning radial ground states of problems defined in all of space.

We shall denote by $\|\cdot\|$ the supremum norm in $C[a, b]$ for any interval $[a, b] \subset \mathbb{R}$.

2. Boundary value problems on a ball

2.1. Introduction

In this section, we consider the existence of positive solutions for the boundary value problems

$$\begin{cases} (r^{N-1} \phi(u'))' + \lambda r^{N-1} f(u) = 0, & 0 < r < R, \\ u'(0) = u(R) = 0, \end{cases} \tag{2.1}$$

where ϕ is an odd increasing homeomorphism on \mathbb{R} and λ is a positive parameter (i.e., we consider the case that $\alpha = \gamma = N - 1$).

As pointed out before, Equation (2.1) arises in the study of radial solutions for quasilinear elliptic boundary value problems of the form

$$\begin{cases} \operatorname{div}(A(\nabla u)) + \lambda f(u) = 0, & x \in \Omega, \\ u = 0, & x \in \partial\Omega, \end{cases} \tag{2.2}$$

where Ω is a ball of radius R in \mathbb{R}^N .

We first discuss existence results for (2.1) when $f(0) = 0$. These results are of bifurcation type and are based on the work [45,46]. We then discuss the cases when $f(0) < 0$ or $f(0) > 0$, and f is ϕ superlinear at ∞ . In the former case there exists a positive, decreasing solution to (2.1) for λ small. The asymptotic behavior of the solution (as $\lambda \rightarrow 0$) will also be discussed. This generalizes the results in [19,2] (see also [100]) in which $\phi(x) = x$, and complements those in [31,74] where similar problems were considered on an annulus. In the latter case, there exists a positive number λ^* such that (2.1) has at least two positive solutions for $\lambda < \lambda^*$, at least one for $\lambda = \lambda^*$, and none for $\lambda > \lambda^*$. This result complements corresponding results in [3,29] on annular domains. We refer to [100] for the literature on problem (2.2) with $A(x) = x$ on bounded domains. The approach used here depends on degree theory and also uses results about upper and lower solutions. Such results can be found in, for example, Lloyd [72], Berger [13], Deimling [32], and Schmitt [99].

2.2. The case when $f(0) = 0$

The prototypical example in this case is the partial differential equation

$$\begin{cases} \Delta u + u^p = 0, & x \in \Omega, \\ u = 0, & x \in \partial\Omega, \end{cases} \tag{2.3}$$

where $p > 1$. Note that $u = 0$ is a solution to (2.3). One approach to finding nontrivial solutions is to consider it as a perturbation of an eigenvalue equation

$$\Delta u + \lambda u + u^p = 0, \tag{2.4}$$

and study solution continua, i.e., curves in the solution set

$$\mathcal{S} = \{(\lambda, u): (\lambda, u) \text{ satisfies (2.4)}\}.$$

For instance, if \mathcal{S} contains a point $(0, u)$ with $u \neq 0$, then we obtain a nontrivial solution to (2.3). Viewing (2.1) with this motivation, we now consider the equation

$$\begin{cases} -r^{1-N}(r^{N-1}\phi(u'))' = \lambda\psi(u) + g(\lambda, u), & 0 < r < R, \\ u'(0) = u(R) = 0, \end{cases} \tag{2.5}$$

where $\phi : \mathbb{R} \rightarrow \mathbb{R}$ and $\psi : \mathbb{R} \rightarrow \mathbb{R}$ are odd increasing homeomorphisms of \mathbb{R} , which both vanish at the origin. We further assume that $g(\lambda, 0) = 0$ for all $\lambda \in \mathbb{R}$. A solution to Equation (2.5) is a function $u \in C^1[0, R]$ with $\phi(u') \in C^1[0, R]$ which satisfies (2.5).

Furthermore we will require that ϕ, ψ satisfy the asymptotic homogeneity conditions:

$$\lim_{s \rightarrow 0} \frac{\phi(\sigma s)}{\psi(s)} = \sigma^{p-1}, \quad \text{for all } \sigma \in \mathbb{R}_+, \text{ for some } p > 1, \tag{2.6}$$

and

$$\lim_{s \rightarrow \pm\infty} \frac{\phi(\sigma s)}{\psi(s)} = \sigma^{q-1}, \quad \text{for all } \sigma \in \mathbb{R}_+, \text{ for some } q > 1. \tag{2.7}$$

We note that if the pair ϕ, ψ satisfies the asymptotic homogeneity conditions (2.6) and (2.7), then the function ϕ satisfies both of these conditions with ψ replaced by ϕ and also ψ satisfies both of these conditions with ϕ replaced by ψ . Such conditions appear in a variety of contexts (see, e.g., [95]).

Let $u(r)$ be a solution of (2.5). By integrating the equation in (2.5) we see that $u(r)$ satisfies the integral equation

$$u(r) = \int_r^R \phi^{-1} \left[\frac{1}{s^{N-1}} \int_0^s \xi^{N-1} (\lambda \psi(u(\xi)) + g(\lambda, u(\xi))) \, d\xi \right] ds. \tag{2.8}$$

This equation will be fundamental for much of the subsequent analysis.

2.2.1. Index calculations. Let us consider (2.5) with $g = 0$:

$$\begin{cases} -r^{1-N} (r^{N-1} \phi(u'))' = \lambda \psi(u), & 0 < r < R, \\ u'(0) = u(R) = 0. \end{cases} \tag{2.9}$$

A value λ such that (2.9) has a nontrivial solution is called an eigenvalue of (2.9). From (2.8) it follows that u is a solution if and only if u is a fixed point of the completely continuous operator $T^\lambda : C[0, R] \rightarrow C[0, R]$ defined by

$$T^\lambda(u)(r) = \int_r^R \phi^{-1} \left[\frac{1}{s^{N-1}} \int_0^s \xi^{N-1} \lambda \psi(u(\xi)) \, d\xi \right] ds. \tag{2.10}$$

If $\phi(t) = \psi(t) = |t|^{p-2}t$, then it is known that the eigenvalue problem (2.9) has a sequence of eigenvalues $\{\lambda_m = \lambda_m(p), m = 1, 2, \dots\}$, with $\lambda_m(p) \rightarrow \infty$, as $\lambda \rightarrow \infty$, and this set has been completely described (see, e.g., [34,36] and the earlier papers [4,69]). We need the following lemma from [46]:

LEMMA 2.1. Consider the problem (2.9).

- If (2.6) holds, then the Leray–Schauder degree of $I - T^\lambda$ is defined for $B(0, \varepsilon)$, (the open ball centered at zero with radius ε in $C[0, R]$), for all sufficiently small ε . Furthermore we have

$$\text{deg}_{\text{LS}}(I - T^\lambda, B(0, \varepsilon), 0) = \begin{cases} 1, & \lambda < \lambda_1(p), \\ (-1)^m, & \lambda \in (\lambda_m(p), \lambda_{m+1}(p)). \end{cases} \tag{2.11}$$

- If (2.7) holds, then the Leray–Schauder degree for $I - T^\lambda$ is defined for $B(0, M)$, for all sufficiently large M , and a similar formula to (2.11) holds, namely

$$\text{deg}_{\text{LS}}(I - T^\lambda, B(0, M), 0) = \begin{cases} 1, & \lambda < \lambda_1(q), \\ (-1)^l, & \lambda \in (\lambda_l(q), \lambda_{l+1}(q)), \end{cases} \tag{2.12}$$

where $\{\lambda_l(q), l = 1, 2, \dots\}$ is the set of eigenvalues of (2.9) with $\phi(t) = \psi(t) = |t|^{q-2}t$.

Lemma 2.1 may be applied to obtain an existence result for nontrivial solutions.

THEOREM 2.2. *Consider problem (2.9) and suppose that ϕ, ψ are odd increasing homeomorphisms of \mathbb{R} with $\phi(0) = 0 = \psi(0)$, which satisfy (2.6) and (2.7) with $p \neq q$. Assume that for some $j \in \mathbb{N}$, $\lambda_j(p) \neq \lambda_j(q)$ and that $\lambda \in (A, B)$, where $A = \min\{\lambda_j(p), \lambda_j(q)\}$ and $B = \max\{\lambda_j(p), \lambda_j(q)\}$. Assume furthermore that (A, B) does not contain any other eigenvalue from $\{\lambda_m(p)\}$ or $\{\lambda_m(q)\}$. Then problem (2.9) has a nontrivial solution.*

PROOF. Assuming for example that $\lambda_j(q) > \lambda_j(p)$, it follows from Lemma 2.1 that

$$\text{deg}_{\text{LS}}(I - T^\lambda, B(0, \varepsilon), 0) = (-1)^j, \tag{2.13}$$

for $\varepsilon > 0$ small, and that

$$\text{deg}_{\text{LS}}(I - T^\lambda, B(0, M), 0) = (-1)^{j-1}, \tag{2.14}$$

for M large. Thus combining (2.13) and (2.14) with the excision property of the Leray–Schauder degree, we obtain that

$$\text{deg}_{\text{LS}}(I - T^\lambda, B(0, M) \setminus \overline{B(0, \varepsilon)}, 0) \neq 0, \tag{2.15}$$

yielding the existence of a nontrivial solution with $\varepsilon < \|u\| < M$. □

This theorem suggests the existence of a branch of solutions to (2.5) connecting $(\lambda_j(p), 0)$ with $(\lambda_j(q), \infty)$, for each $j \in \mathbb{N}$, generalizing the well-known property for the homogeneous case. We will return to the structure of the eigenvalue set in Section 2.2.4.

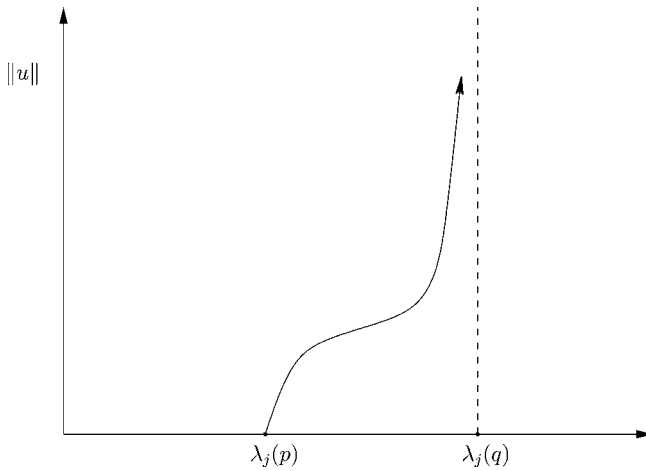

Fig. 1. Possible continua of Theorem 2.2.

2.2.2. On initial value problems. In this section we discuss some results for the initial value problem associated with (2.5), i.e.,

$$\begin{cases} -r^{1-N} (r^{N-1} \phi(u'))' = \lambda \psi(u) + g(\lambda, u), & 0 < r < R, \\ u(0) = d, \\ u'(0) = 0, \end{cases} \tag{2.16}$$

which will be needed in the next section. Throughout we shall assume that

$$ug(\lambda, u) \geq 0, \quad \text{for all } \lambda, u \in \mathbb{R}. \tag{2.17}$$

The following proposition follows from an application of the contraction mapping principle applied to (2.8):

PROPOSITION 2.3. *Suppose that $g(\lambda, u) = O(|\psi(u)|)$ near zero, uniformly for r and λ in bounded intervals. Then the only solution to the problem*

$$\begin{cases} -r^{1-N} (r^{N-1} \phi(u'))' = \lambda \psi(u) + g(\lambda, u), & 0 < r < R, \\ u(r_0) = 0, \\ u'(r_0) = 0, \end{cases} \tag{2.18}$$

with $r_0 \in [0, R]$ is the trivial solution $u = 0$.

The next result concerns the oscillation of nontrivial solutions.

PROPOSITION 2.4. *Suppose that $g(\lambda, u) = O(|\psi(u)|)$ near zero, uniformly for λ in bounded intervals, then nontrivial solutions of the initial value problem (2.16) are oscillatory, i.e., solutions are defined on all of $[0, \infty)$ and have infinitely many zeros.*

PROOF. Let u be a nontrivial solution of (2.16) and assume that $d > 0$. If u does not vanish in $(0, \infty)$, then u is decreasing on $(0, \infty)$. Integrating the equation from 0 to $s \in (0, r)$ we find

$$-u'(s) = \phi^{-1} \left(\frac{1}{s^{N-1}} \int_0^s \xi^{N-1} (\lambda \psi(u(\xi)) + g(\lambda, u(\xi))) \, d\xi \right). \tag{2.19}$$

Integrating (2.19) from $r/2$ to r yields

$$u(r/2) \geq \int_{r/2}^r \phi^{-1} \left(\frac{\lambda}{s^{N-1}} \int_0^s \xi^{N-1} \psi(u(\xi)) \, d\xi \right) \, ds, \tag{2.20}$$

$$\geq \int_{r/2}^r \phi^{-1} \left(\frac{\lambda}{r^{N-1}} \int_0^{r/2} \xi^{N-1} \psi(u(r/2)) \, d\xi \right) \, ds. \tag{2.21}$$

Hence

$$\frac{\phi(\frac{2}{r}u(r/2))}{\phi(u(r/2))} \geq \frac{\lambda}{N} \frac{r}{2^N} \frac{\psi(u(r/2))}{\phi(u(r/2))}, \tag{2.22}$$

for any $r > 0$. But for $r > 2$ the left-hand side of (2.22) is less than 1 while the right-hand side can be arbitrarily large. Hence we conclude that u must have a zero which, by Proposition 2.3, is simple. □

We remark here that by the same argument any nontrivial solution of the initial value problem

$$\begin{cases} -(r^{N-1}\phi(v'))' = r^{N-1}\lambda\psi(v) + r^{N-1}g(\lambda, v), & 0 < r < R, \\ v(r_0) = d, \\ v'(r_0) = 0, \end{cases} \tag{2.23}$$

must have a first isolated zero to the right of r_0 and such solutions may be continued to ∞ and are oscillatory on the whole real line.

For each $d \neq 0$, let ρ_d denote the first zero of a solution u of (2.5) such that $u(0) = d$. The next two propositions show that solutions to (2.5) have Sturm type separation properties as one has for linear equations (see, e.g., [55]):

PROPOSITION 2.5. *Suppose that $g(\lambda, u) = O(|\psi(u)|)$ near zero, uniformly for λ in bounded intervals. Then, for each $R > 0$ there exists $\Lambda(R)$ such that for all $\lambda > \Lambda(R)$ and all $d \neq 0$ we have that $\rho_d \leq R$.*

PROPOSITION 2.6. *Let ρ_{d_j} denote the j th zero of a solution u of (2.5) such that $u(0) = d$ and suppose that $g(\lambda, u) = O(|\psi(u)|)$ near zero, uniformly for λ in bounded intervals. Then, for all $L > 0$ and $j \in \mathbb{N}$ there exists $\Lambda_j(L) > 0$ such that for all $\lambda > \Lambda_j(L)$ and all $d \neq 0$ we have that $\rho_{d_j} \leq L$.*

2.2.3. Bifurcation of solutions. In this section we consider bifurcation problems at zero and at infinity. See [21,32,94,64] for definitions.

Let u be a solution of problem (2.5). Then u satisfies

$$u = \mathcal{F}(\lambda, u) \tag{2.24}$$

where

$$\mathcal{F}(\lambda, u)(r) = \int_r^R \phi^{-1} \left(\frac{1}{s^{N-1}} \int_0^s \xi^{N-1} (\lambda \psi(u(\xi)) + g(\lambda, u(\xi))) \, d\xi \right) \, ds. \tag{2.25}$$

It is clear that $\mathcal{F} : \mathbb{R} \times C[0, R] \rightarrow C[0, R]$ and it is a completely continuous operator. Concerning (2.24), the following theorem is proved by a standard argument which considers a sequence of solutions approaching a bifurcation point, appropriately renormalized to take advantage of the condition on g :

THEOREM 2.7. (i) *Suppose that $g : \mathbb{R} \times \mathbb{R} \rightarrow \mathbb{R}$ is continuous and satisfies $g(\lambda, s) = o(|\phi(s)|)$ near $s = 0$ uniformly for λ in bounded intervals, and that ϕ and ψ satisfy (2.6). If $(\bar{\lambda}, 0)$ is a bifurcation point for (2.24), then $\bar{\lambda} = \lambda_m(p)$, for some $m \in \mathbb{N}$.*

(ii) *Suppose that $g : \mathbb{R} \times \mathbb{R} \rightarrow \mathbb{R}$ is continuous and satisfies $g(\lambda, s) = o(|\phi(s)|)$ near infinity, uniformly for λ in bounded intervals, and that ϕ and ψ satisfy (2.7). If $(\bar{\lambda}, \infty)$ is a bifurcation point for (2.24), then $\bar{\lambda} = \lambda_m(q)$, for some $m \in \mathbb{N}$.*

The next theorem is the main result on bifurcation of solutions to (2.24):

THEOREM 2.8. *Suppose that $g : \mathbb{R} \times \mathbb{R} \rightarrow \mathbb{R}$ is continuous and satisfies $g(\lambda, s) = o(|\phi(s)|)$ near $s = 0$, uniformly for λ in bounded intervals.*

(i) *If ϕ and ψ satisfy (2.6), then for each $k \in \mathbb{N}$ there is a connected component $\mathcal{S}_k \subset \mathbb{R} \times C[0, 1]$ of the set of nontrivial solutions of (2.5) whose closure $\overline{\mathcal{S}_k}$ contains $(\lambda_k(p), 0)$. Moreover, \mathcal{S}_k is unbounded in $\mathbb{R} \times C[0, 1]$ and if $(\lambda, u) \in \mathcal{S}_k$, then u has exactly $k - 1$ simple zeros in $(0, R)$.*

(ii) *If $ug(\lambda, u) \geq 0$, then there exists $M_k \in (0, \infty)$ such that if $(\lambda, u) \in \mathcal{S}_k$, then $\lambda \leq M_k$.*

PROOF. The proof of the existence of the connected component \mathcal{S}_k such that $(\lambda_k(p), 0)$ belongs to $\overline{\mathcal{S}_k}$ and that \mathcal{S}_k is unbounded or contains another bifurcation point $(\lambda_j(p), 0)$, $j \neq k$, is entirely similar to that of [94]. The fact that $(\lambda_k(p), 0) \in \overline{\mathcal{S}_k}$ and that $(\lambda, u) \in \mathcal{S}_k$ implies u has exactly $k - 1$ simple zeros in $(0, R)$ is in turn similar to that of Theorem 4.1 of [34] and uses the results of Section 2.2.2. The existence of M_k such that $\lambda \leq M_k$ follows directly from Proposition 2.6. □

The following will serve as examples to illustrate the above results.

THEOREM 2.9. *Suppose that ϕ, ψ are odd increasing homeomorphisms of \mathbb{R} with $\phi(0) = \psi(0) = 0$, which satisfy (2.6) and (2.7) with $p \neq q$ and $ug(\lambda, u) \geq 0$. Then for any $j \in \mathbb{N}$,*

there exists a connected component S_j of the set on nontrivial solutions of (2.5) connecting $(\lambda_j(p), 0)$ to $(\lambda_j(q), \infty)$ such that $(\lambda, u) \in S_j$ implies u has exactly $j - 1$ simple zeros in $(0, R)$.

PROOF. It follows from Theorem 2.8 that for any $j \in \mathbb{N}$, there exists an unbounded connected component S_j of the set on nontrivial solutions emanating from $(\lambda_j(p), 0)$ such that $(\lambda, u) \in S_j$ implies u has exactly $j - 1$ simple zeros in $(0, R)$. Since there is an M_j such that $(\lambda, u) \in S_k$ implies that $\lambda \leq M_k$ and since there are no nontrivial solutions of (2.5) for $\lambda = 0$, it follows that for any $M > 0$, there is $(\lambda, u) \in S_k$ such that $\|u\| > M$. Hence (ii) of Theorem 2.7 implies that as $\|u\| \rightarrow \infty$ with $(\lambda, u) \in S_k$, it must be that $\lambda \rightarrow \lambda_j(q)$. \square

The second application is motivated by a result of [34].

THEOREM 2.10. *Consider the problem*

$$\begin{cases} -(r^{N-1}\phi(u'))' = r^{N-1}g(u), & 0 < r < R, \\ u'(0) = u(R) = 0. \end{cases} \tag{2.26}$$

Assume ϕ is an increasing homeomorphisms of \mathbb{R} with $\phi(0) = 0$ and which satisfies (2.6) and (2.7) with $\phi = \psi$. Further suppose that $g : \mathbb{R} \rightarrow \mathbb{R}$ is continuous with $ug(u) \geq 0$ and that there exist positive integers k and n , with $k \leq n$, such that

$$\mu := \lim_{|s| \rightarrow 0} \frac{g(s)}{\phi(s)} < \lambda_k(p) \leq \lambda_n(q) < \nu := \lim_{|s| \rightarrow \infty} \frac{g(s)}{\phi(s)}.$$

Then for each integer $j \in (k, n)$ Equation (2.26) has a solution with exactly $j - 1$ simple zeros in $(0, R)$. Thus (2.26) possesses at least $n - k + 1$ nontrivial solutions.

2.2.4. On principal eigenvalues. We next present results concerning the existence of positive solutions to the problem

$$\begin{cases} -r^{1-N}(r^{N-1}\phi(u'))' = \lambda\psi(u), & 0 < r < R, \\ u'(0) = u(R) = 0, \end{cases} \tag{2.27}$$

where ϕ is an increasing homeomorphism of \mathbb{R} and ψ is nondecreasing with $\phi(0) = \psi(0) = 0$. A constant λ such that (2.27) has a positive (or negative) solution is called a principal eigenvalue. Note that Theorem 2.2 established the existence of solution branches to (2.27) which may or may not correspond to positive solutions.

In the case that N is a positive integer and $\phi(u) = |u|^{p-2}u = \psi(u)$ the above problem is the problem of the existence of the principal eigenvalue of the p -Laplacian on a ball of radius R in \mathbb{R}^N , subject to zero Dirichlet boundary data. As such it is well understood (see, e.g., [4,14,41,43,103]).

The tools that have been used for establishing the existence of such (and higher) eigenvalues come from variational methods and are usually critical point theorems for smooth functionals defined in an appropriate Sobolev space; these methods consequently also yield

theorems for the case the underlying ball domain is replaced by an arbitrary bounded domain.

Here we discuss the general case (2.27) and rely on fixed point and continuation techniques based on some work in [29,46]. For the special case $N = 1$, very detailed information is available in [34,48].

We will assume further that $N \geq 1$ (not necessarily an integer) and ϕ and ψ satisfy for all $x \neq 0$ and $\sigma > 0$,

$$A(\sigma) \leq \frac{\phi(\sigma|s|)}{\psi(|s|)} \leq B(\sigma), \tag{2.28}$$

where $A(\sigma)$ and $B(\sigma)$ are positive constants depending on σ only.

We introduce some notation to discuss the structure of the eigenvalue set. First, let E denote the set of all principal eigenvalues. Next, for each $d > 0$, let $\Gamma(d, R)$ be defined by

$$\Gamma(d, R) = \{ \lambda > 0 \mid (2.27) \text{ has a positive solution with } u(0) = d \} \tag{2.29}$$

and set

$$\Gamma^-(d, R) = \inf \Gamma(d, R). \tag{2.30}$$

Further define

$$\Gamma_1^-(R) := \liminf_{d \rightarrow \infty} \Gamma^-(d, R), \tag{2.31}$$

$$\gamma_1^-(R) := \liminf_{d \rightarrow 0} \Gamma^-(d, R), \tag{2.32}$$

$$\lambda_1^-(R) := \inf_{d > 0} \Gamma^-(d, R). \tag{2.33}$$

The main result in this section is as follows:

THEOREM 2.11. *The set $E \neq \emptyset$ and there exists a smallest $\lambda_0 > 0$ such that for $\lambda < \lambda_0$ the eigenvalue problem (2.27) has no nontrivial solutions. For every $d > 0$, there exists $\lambda \in E$ and a positive solution u of (2.27) such that $u(0) = d$. Furthermore, $\Gamma^-(d, R) > 0$ and $\Gamma_1^-(R), \gamma_1^-(R), \lambda_1^-(R)$ are all nonincreasing functions of R , and*

$$\lim_{R \rightarrow 0^+} \Gamma_1^-(R) = \lim_{R \rightarrow 0^+} \gamma_1^-(R) = \lim_{R \rightarrow 0^+} \lambda_1^-(R) = \infty,$$

$$\lim_{R \rightarrow \infty} \Gamma_1^-(R) = \lim_{R \rightarrow \infty} \gamma_1^-(R) = \lim_{R \rightarrow \infty} \lambda_1^-(R) = 0.$$

There is a result dual to Theorem 2.11 for principal eigenvalues with associated negative solutions, the set of such eigenvalues may, of course, be different from the set whose existence is asserted in Theorem 2.11.

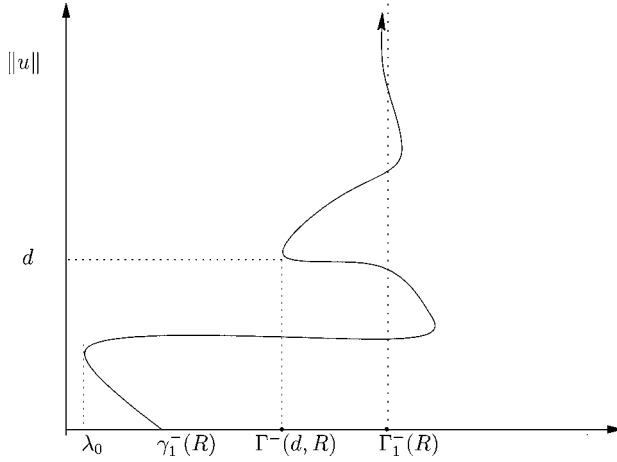

Fig. 2. Possible continua of Theorem 2.11.

We break the proof of Theorem 2.11 into several steps. First, a quick calculation shows that finding positive solutions to problem (2.27) is equivalent to finding nontrivial solutions to the problem

$$\begin{cases} (r^{N-1}\phi(u'))' + \lambda r^{N-1}\psi(|u|) = 0, & r \in (0, R), \\ u'(0) = u(R) = 0. \end{cases} \tag{2.34}$$

Let C_R denote the closed subspace of $C[0, R]$ defined by

$$C_R = \{u \in C[0, R] \mid u(R) = 0\}. \tag{2.35}$$

Then C_R is a Banach space with the inherited norm $\|\cdot\|$ from $C[0, R]$.

Similar to (2.8), we see that a solution u to (2.34) is equivalent to a fixed point of the operator

$$\mathcal{F}(\lambda, u)(r) = \int_r^R \phi^{-1} \left[\frac{1}{s^{N-1}} \int_0^s \xi^{N-1} \lambda \psi(|u(\xi)|) \, d\xi \right] \, ds. \tag{2.36}$$

Clearly $\mathcal{F} : [0, \infty) \times C_R \rightarrow C_R$ is a well-defined operator. Define now the operator $\mathcal{F}_\epsilon : [0, \infty) \times C_R \rightarrow C_R$, by

$$\mathcal{F}_\epsilon(\lambda, u)(r) = \int_r^R \phi^{-1} \left[\frac{1}{s^{N-1}} \int_0^s \xi^{N-1} \lambda (\psi(|u(\xi)|) + \epsilon) \, d\xi \right] \, ds, \tag{2.37}$$

where $\epsilon > 0$ is a constant. We have that \mathcal{F}_ϵ sends bounded sets of $[0, \infty) \times C_R$ into bounded sets of C_R . Moreover, \mathcal{F}_ϵ is a completely continuous operator and $\mathcal{F}_\epsilon(0, \cdot) = 0$.

Since

$$\text{deg}_{\text{LS}}(I - \mathcal{F}_\epsilon(0, \cdot), B(0, R), 0) = 1,$$

there exists a solution continuum $\mathcal{C}_\epsilon^+ \subset [0, \infty) \times C_R$ of solutions of

$$u = \mathcal{F}_\epsilon(\lambda, u) \tag{2.38}$$

with \mathcal{C}_ϵ^+ unbounded in $[0, \infty) \times C_R$. In fact, this solution continuum \mathcal{C}_ϵ^+ is bounded in the λ direction:

LEMMA 2.12. *There exists $\bar{\lambda} > 0$ such that if (λ, u) solve (2.27), then $\lambda \leq \bar{\lambda}$.*

PROOF. Let (λ, u) be a solution pair to (2.27). Thus

$$r^{N-1} \phi(u'(r)) = -\lambda \int_0^r \xi^{N-1} (\psi(|u(\xi)|) + \epsilon) d\xi \leq 0$$

and

$$u(r) = \int_r^R \phi^{-1} \left[\frac{1}{s^{N-1}} \int_0^s \xi^{N-1} \lambda (\psi(|u(\xi)|) + \epsilon) d\xi \right] ds \geq 0.$$

Hence, $u'(r) \leq 0$ and $u(r) \geq 0$ for all $r \in [0, R]$. Also

$$u(r) \geq \int_r^R \phi^{-1} \left[\frac{1}{s^{N-1}} \int_0^s \xi^{N-1} \lambda \psi(|u(\xi)|) d\xi \right] ds.$$

Thus, for all $r \in [\frac{R}{4}, \frac{3R}{4}]$, we have that

$$u(r) \geq \frac{R}{4} \phi^{-1} \left[\frac{\lambda R}{N4^N} \psi(u(r)) \right]$$

or equivalently,

$$\frac{\phi(\frac{4}{R}u(r))}{\psi(u(r))} \geq \lambda \frac{R}{N4^N}. \tag{2.39}$$

□

Note that it follows from (2.39) and (2.28) that for all $\epsilon > 0$, sufficiently small, λ is bounded independent of ϵ . Thus, there exists ϵ_0 such that for each $d > 0$ and each $0 < \epsilon \leq \epsilon_0$ there exists $(\lambda_\epsilon, u_\epsilon) \in \mathcal{C}_\epsilon^+$, with $\|u_\epsilon\| = d > 0$ and $0 < \lambda_\epsilon \leq \bar{\lambda}$. We may now let $\epsilon \rightarrow 0$ and obtain a nontrivial solution of (2.27), with $\|u\| = d$, for some $\lambda^* \in (0, \bar{\lambda}]$.

Similar to (2.30) define

$$\Gamma^+(d, R) = \sup \Gamma(d, R).$$

It follows from the above calculations that $\Gamma^+(d, R) < \infty$. We now prove $\Gamma^-(d, R) > 0$ from Theorem 2.11:

PROPOSITION 2.13. *For each $d > 0$, $\Gamma^-(d, R) > 0$.*

PROOF. If not, then there exist sequences $\{u_n\}, \{\lambda_n\}$, with $\|u_n\| = d$ and $\lambda_n \rightarrow 0$ such that $u_n = \mathcal{F}(\lambda_n, u_n)$. The complete continuity of \mathcal{F} implies $\{u_n\}$ has a convergent subsequence, with $u_{n_j} \rightarrow u^*$, and thus $u^* = \mathcal{F}(0, u^*)$. But it follows from (2.36) that $\mathcal{F}(0, u) = 0$ for all u , a contradiction. □

Paralleling our notation above, let us set

$$\Gamma_1^+(R) = \limsup_{d \rightarrow \infty} \Gamma^+(d, R), \tag{2.40}$$

$$\gamma_1^+(R) = \limsup_{d \rightarrow 0} \Gamma^+(d, R), \tag{2.41}$$

$$\lambda_1^+(R) = \sup_{d > 0} \Gamma^+(d, R). \tag{2.42}$$

Then, we have:

PROPOSITION 2.14. *Under the above hypotheses on ϕ and ψ ,*

$$\begin{aligned} \Gamma_1^-(R) &> 0, & \Gamma_1^+(R) &< \infty, \\ \gamma_1^-(R) &> 0, & \gamma_1^+(R) &< \infty, \\ \lambda_1^-(R) &> 0, & \lambda_1^+(R) &< \infty. \end{aligned}$$

PROOF. That the numbers in the second column are finite has already been discussed. To show that the numbers in the first column are positive we argue as follows. Assume (λ, u) is a solution of (2.34) with $u(0) = d$. Then

$$\|u\| = d,$$

and

$$u(r) = \int_r^R \phi^{-1} \left[\frac{1}{s^{N-1}} \int_0^s \xi^{N-1} \lambda \psi(|u(\xi)|) \, d\xi \right] \, ds. \tag{2.43}$$

Hence

$$d = u(0) \leq \int_0^R \phi^{-1} \left[\lambda \psi(d) \frac{s}{N} \right] \, ds,$$

which implies

$$\frac{\phi(d/R)}{\psi(d)} \leq \lambda \frac{R}{N}. \tag{2.44}$$

Using condition (2.28) we obtain a lower bound for λ . □

The above proposition has the following corollary:

COROLLARY 2.15. *Let (λ, u) be a solution of (2.34) with $u(0) = d$ and let $\theta \in (0, 1)$ be fixed. Let $r_0 \in (0, R)$ be such that $u(r_0) = \theta d$. Then*

$$r_0 \geq \frac{N}{\lambda} A \left(\frac{1 - \theta}{R} \right). \tag{2.45}$$

PROOF. Using Equation (2.43) we obtain the following

$$\theta d = \int_{r_0}^R \phi^{-1} \left[\frac{1}{s^{N-1}} \int_0^s \xi^{N-1} \lambda \psi(|u(\xi)|) d\xi \right] ds, \tag{2.46}$$

and hence

$$(1 - \theta)d = \int_0^{r_0} \phi^{-1} \left[\frac{1}{s^{N-1}} \int_0^s \xi^{N-1} \lambda \psi(|u(\xi)|) d\xi \right] ds,$$

from which follows

$$(1 - \theta)d \leq \int_0^{r_0} \phi^{-1} \left[\frac{1}{s^{N-1}} \int_0^s \xi^{N-1} \lambda \psi(d) d\xi \right] ds,$$

and

$$(1 - \theta)d \leq R \phi^{-1} \left[\frac{\lambda \psi(d) r_0}{N} \right].$$

The result now follows from (2.28). □

The result just proved has the following consequence concerning solutions of large norm:

COROLLARY 2.16. *Let $\{(\lambda_n, u_n)\}$ be a sequence of solutions of (2.34) with $u_n(0) = d_n$. If $d_n \rightarrow \infty$ as $n \rightarrow \infty$, then $u_n(r) \rightarrow \infty$ uniformly with respect to r in compact subintervals of $[0, R)$.*

PROOF. Since u_n is given by

$$u_n(r) = \int_r^R \phi^{-1} \left[\frac{1}{s^{N-1}} \int_0^s \xi^{N-1} \lambda_n \psi(|u_n(\xi)|) d\xi \right] ds,$$

for $\theta \in (0, 1)$ we obtain for $r \geq r_0$ (viz. Corollary 2.15) that

$$u_n(r) \geq \int_r^R \phi^{-1} \left[\frac{1}{s^{N-1}} \int_0^{r_0} \xi^{N-1} \lambda_n \psi(\theta d_n) d\xi \right] ds.$$

The conclusion follows from this inequality. □

Let us consider the initial value problem

$$\begin{cases} -(r^{N-1}\phi(u'))' = \lambda r^{N-1}\psi(u), & r > 0, \\ u(0) = d > 0, \\ u'(0) = 0. \end{cases} \tag{2.47}$$

To obtain the (local) existence of solutions of (2.47) we obtain solutions of an equivalent integral equation whose solutions are fixed points of the operator S defined by

$$S(u)(r) = d - \int_0^r \phi^{-1} \left[\frac{1}{s^{N-1}} \int_0^s \xi^{N-1} \lambda \psi(u(\xi)) \, d\xi \right] ds.$$

Since u is decreasing and ϕ and ψ are increasing we find that for given $\epsilon > 0$, there exists R_0 such that

$$S : \{u \in C[0, R_0] : \|u - d\| \leq \epsilon\} \rightarrow \{u \in C[0, R_0] : \|u - d\| \leq \epsilon\}$$

and that S is completely continuous. The result thus follows from Schauder’s fixed point theorem. We next show that solutions of the initial value problem (2.47) exist globally and are oscillatory:

PROPOSITION 2.17. *For each $d > 0$ and each $\lambda > 0$ solutions of (2.47) exist globally on $[0, \infty)$, have only simple zeros and are oscillatory, i.e., the set of zeros is unbounded.*

PROOF. It follows from the above existence argument that a solution u of (2.47), as long as it is positive, is decreasing. If $u(r) \geq 0$ for $r \in [0, \infty)$, then using calculations as before, we find that for each $r > 0$

$$u(r) \geq r\phi^{-1} \left(\frac{\lambda r \psi(u(r))}{N2^{N-1}} \right),$$

and hence (since we may assume $r \geq 1$)

$$\frac{\phi(u(r))}{\psi(u(r))} \geq \frac{\lambda r}{N2^{N-1}},$$

which implies, using condition (2.28) that r cannot be unbounded. Therefore u must have a first zero. Easy arguments show that the zeros of u must be simple and that u is oscillatory. □

We next shall show that $\lambda_1^-(R)$, $\gamma_1^-(R)$ and $\Gamma_1^-(R)$ are nonincreasing functions of R . To this end we shall need the following elementary properties of the operator \mathcal{F} defined by Equation (2.36). We note that the space C_R is a partially ordered Banach space with

respect to the partial order \leq defined by $u \leq v$ whenever $u(r) \leq v(r)$ for all $r \in [0, R]$. Further if $[u, v] = \{w \in C_R : u \leq w \leq v\}$ is an order interval in C_R , then it is a bounded closed set in C_R .

PROPOSITION 2.18. *The operator \mathcal{F} defined by (2.36) is monotone with respect to the above partial order in $C[0, R]$ and hence in C_R and also monotone with respect to λ .*

From this proposition and the complete continuity of \mathcal{F} immediately follows the following fixed point result:

PROPOSITION 2.19. *Assume there exists $[\alpha, \beta] \subset C[0, R]$ such that*

$$\mathcal{F}(\lambda, \cdot) : [\alpha, \beta] \rightarrow [\alpha, \beta].$$

Then $\mathcal{F}(\lambda, \cdot)$ has a fixed point $u \in C_R \cap [\alpha, \beta]$.

We note that the hypotheses of Proposition 2.19 will hold, whenever we can find a pair $\{\alpha, \beta\} \subset C[0, R]$ such that

$$\alpha \leq \beta$$

and

$$\alpha \leq \mathcal{F}(\lambda, \alpha), \mathcal{F}(\lambda, \beta) \leq \beta.$$

Using these facts we can now establish the following result:

THEOREM 2.20. $\lambda_1^-, \gamma_1^-, \Gamma_1^-$ are nonincreasing functions of R .

PROOF. Assume there exist constants R_1 and R_2 , with $R_1 < R_2$, such that $\lambda_1^-(R_1) < \lambda_1^-(R_2)$. Then there exists $\mu \in (\lambda_1^-(R_1), \lambda_1^-(R_2))$, such that (2.27) has a nontrivial solution $\tilde{\alpha}$ for $R = R_1$ and $\lambda = \mu$. Furthermore, there exists $\nu \geq \lambda_1^-(R_2)$ and a nontrivial solution β of (2.27) for $R = R_2$ and $\lambda = \nu$, with $\beta(0) = d$ as large as desired. It follows from Corollary 2.16 that for d sufficiently large $\beta(r) > \tilde{\alpha}(r)$, for each $r \in [0, R_1]$. Define

$$\alpha = \begin{cases} \tilde{\alpha}, & 0 \leq r \leq R_1, \\ 0, & R_1 \leq r \leq R_2. \end{cases}$$

Then the operator $\mathcal{F}(\mu, \cdot)$ for $R = R_2$ satisfies in the space $C[0, R_2]$

$$\alpha \leq \mathcal{F}(\mu, \alpha), \mathcal{F}(\mu, \beta) \leq \beta,$$

as may easily be verified. Thus by Proposition 2.19 this operator will have a fixed point in $[\alpha, \beta]$, contradicting that $\mu < \lambda_1^-(R_2)$. The monotonicity of the other functions is proved using virtually similar arguments. \square

REMARK 2.21.

1. Theorem 2.20 implies that problem (2.27) has no nontrivial solutions for $\lambda < \lambda_1^-(R)$.
2. Solutions of (2.27) are a priori bounded for λ in compact subintervals of $(-\infty, \Gamma_1^-(R))$.
3. The calculations and results also imply that for $\delta > 0$, sufficiently small, the degrees

$$\begin{aligned} & \text{deg}_{\text{LS}}(I - \mathcal{F}(a, \cdot), B(0, \delta), 0), \\ & \text{deg}_{\text{LS}}(I - \mathcal{F}(b, \cdot), B(0, \delta), 0) \end{aligned}$$

are defined for $a < \gamma_1^-(R)$ and $b > \gamma_1^+(R)$ and equal 1 and 0, respectively. Hence it follows from global bifurcation theory that an unbounded continuum of positive solutions of (2.27) will bifurcate from $[\gamma_1^-(R), \gamma_1^+(R)]$.

We conclude this section with a few remarks concerning the nonhomogeneous equation

$$\begin{cases} (r^{N-1}\phi(u'))' + \lambda r^{N-1}\psi(u) = r^{N-1}h(r), & r \in (0, R), \\ u'(0) = u(R) = 0, \end{cases} \tag{2.48}$$

where $h \in L^\infty(0, R)$ is a given function. In this case, one has the following theorem:

THEOREM 2.22. *There exists $\lambda_0 > 0$ such that for every $\lambda < \lambda_0$ and every function $h \in L^\infty(0, R)$ the nonhomogeneous problem (2.48) has a solution.*

As is to be expected, λ_0 in this theorem is to the left of the set of principal eigenvalues associated with both positive and negative eigenfunctions.

PROOF. The existence of solutions to the nonhomogeneous problem is equivalent to the existence of fixed points of the operator $T(\lambda, u, h)$ defined by

$$T(\lambda, u, h)(r) = \int_r^R \phi^{-1} \left[\frac{1}{s^{N-1}} \int_0^s \xi^{N-1} (\lambda \psi(u(\xi)) - h(r)) \, d\xi \right] \, ds. \tag{2.49}$$

One establishes the existence of a fixed point of T in the space C_R using Proposition 2.19. To this end, we define

$$\lambda_0 = \inf \{ \lambda : \lambda \text{ is a principal eigenvalue of (2.27)} \}$$

and consider problem (2.48) for values of $\lambda < \lambda_0$. Let λ be so chosen and choose μ such that $\lambda < \mu < \lambda_0$ and consider the boundary value problem:

$$\begin{cases} (r^{N-1}\phi(u'))' + \mu r^{N-1}\psi(u) = 0, & 0 < r < R, \\ u'(0) = u(R) = 0. \end{cases} \tag{2.50}$$

It then follows from the results considered earlier that there exists a solution u with $u(0) = d$ as large as we like. Then u satisfies also

$$u(r) = \int_r^R \phi^{-1} \left[\frac{1}{s^{N-1}} \int_0^s \xi^{N-1} \mu \psi(u(\xi)) \, d\xi \right] ds.$$

Further $u(r)$ may be made arbitrarily large uniformly on compact subintervals of $[0, R]$ by choosing d sufficiently large. Hence

$$\begin{aligned} u(r) &= \int_r^R \phi^{-1} \left[\frac{1}{s^{N-1}} \int_0^s \xi^{N-1} \mu \psi(u(\xi)) \, d\xi \right] ds \\ &= \int_r^R \phi^{-1} \left[\frac{1}{s^{N-1}} \int_0^s \xi^{N-1} (\lambda \psi(u(\xi)) - h) \, d\xi \right. \\ &\quad \left. + \frac{1}{s^{N-1}} \int_0^s \xi^{N-1} ((\mu - \lambda) \psi(u(\xi)) + h) \, d\xi \right] ds \\ &\geq T(\lambda, u, h)(r) \end{aligned}$$

provided

$$\frac{1}{s^{N-1}} \int_0^s \xi^{N-1} ((\mu - \lambda) \psi(u(\xi)) + h) \, d\xi \geq 0, \quad \text{for } s \in [0, R],$$

which may be accomplished for a given $h \in L^\infty(0, R)$, by choosing d sufficiently large. In a similar manner we may construct a negative α such that $\alpha \leq T(\lambda, \alpha, h)$. We now apply Proposition 2.19 to complete the proof. \square

2.2.5. Existence and nonexistence. We next consider existence and nonexistence questions for the following class of problems:

$$\begin{cases} (r^{N-1} \phi(u'))' + r^{N-1} g(u) = 0, & r \in (0, R), \\ u'(0) = u(R) = 0, \end{cases} \tag{2.51}$$

where ϕ is an odd increasing homeomorphism of \mathbb{R} and $g: \mathbb{R} \rightarrow \mathbb{R}$ is a nondecreasing continuous function such that $g(0) = 0$.

Motivated by the case of the p -Laplace operator and related work (see, e.g., [29,48]), we will assume that ϕ satisfies:

$$\limsup_{s \rightarrow \infty} \frac{\phi(\sigma s)}{\phi(s)} < \infty, \quad \text{for all } \sigma > 1 \tag{2.52}$$

and

$$\limsup_{s \rightarrow 0} \frac{\phi(\sigma s)}{\phi(s)} < \infty, \quad \text{for all } \sigma > 1. \tag{2.53}$$

Let

$$\Phi(s) = \int_0^s \phi(t) dt, \quad G(s) = \int_0^s g(t) dt,$$

and denote by

$$\Gamma := \limsup_{s \rightarrow \infty} \frac{\Phi(s)}{s\phi(s)},$$

and for $\theta \in (0, 1)$,

$$\delta_\theta := \liminf_{s \rightarrow \infty} \frac{G(\theta s)}{sg(s)}.$$

The main existence result is the following:

THEOREM 2.23. *Suppose that $\Gamma < 1$ and*

$$\lim_{s \rightarrow 0} \frac{\phi(s)}{g(s)} = \infty, \quad \lim_{s \rightarrow \infty} \frac{g(s)}{\phi(s)} = \infty. \tag{2.54}$$

Further let there exist $\theta \in (0, 1)$ such that $\delta_\theta > 0$ and

$$N\delta_\theta > N\Gamma - 1. \tag{2.55}$$

Then (2.51) has at least one positive solution.

Condition (2.55) has been used in [48] to indicate subcritical growth of g with respect to ϕ . In the case of powers, i.e., when $\phi(s) = |s|^{p-2}s$ and $g(s) = |s|^{\delta-1}s$, with $1 < p < N$ and $\delta > 0$, this condition reads

$$\delta < \frac{N(p-1) + p}{N-p}, \tag{2.56}$$

which is known to be optimal in the sense that there are no positive solutions to (2.51) if

$$\delta \geq \frac{N(p-1) + p}{N-p}. \tag{2.57}$$

On the other hand, if we let $\phi(s) = \ln(1 + |s|)|s|^{p-2}s$ then one has a solution for $p < \delta \leq \frac{N(p-1)+p}{N-p}$. Thus if we allow slightly faster growth we can include equality in (2.56) [23].

In the case of general ϕ and g , the main nonexistence result is the following:

THEOREM 2.24. *If*

$$\sup_{s \geq 0} \frac{NG(s)}{sg(s)} \leq \inf_{s \geq 0} \frac{N\Phi(s)}{s\phi(s)} - 1, \tag{2.58}$$

then (2.51) does not have a positive solution.

Condition (2.55) is related to a condition that appears to have been first used by Castro and Kurepa in [18,17] for the linear operator, i.e., when $\phi(s) = s$. De Thélin and El Hachimi [37] extended the results in [17] to the p -Laplacian case by assuming that $NG(s) - \frac{N-p}{p}sg(s)$ is bounded from below for all $s \in \mathbb{R}$ and for some $\theta \in (0, 1)$,

$$NG(\theta d) - \frac{N-p}{p}dg(d) \geq 0, \quad \text{for } d \text{ large.} \tag{2.59}$$

We note here that although condition (2.59) seems to relax the conditions in [18], it can be proved to be equivalent when $p = 2$ and g is increasing (see [47]).

PROOF OF THEOREM 2.23. By radial symmetry, finding positive solutions to problem (2.51) is equivalent to finding nontrivial solutions to the problem

$$\begin{cases} (r^{N-1}\phi(u'))' + r^{N-1}g(|u|) = 0, & r \in (0, R), \\ u'(0) = u(R) = 0. \end{cases} \tag{2.60}$$

Recall from (2.35) that C_R is the closed subspace of $C[0, R]$ defined by those u that vanish at R . Let u be a solution of (2.60). If $T_0 : C_R \rightarrow C_R$ is defined by

$$T_0(u)(r) = \int_r^R \phi^{-1} \left[\frac{1}{s^{N-1}} \int_0^s \xi^{N-1} g(|u(\xi)|) d\xi \right] ds, \tag{2.61}$$

then T_0 is well defined and fixed points of T_0 will provide solutions of (2.60). Define now the operator $\mathcal{G} : [0, R] \times C_R \rightarrow C_R$, by

$$\mathcal{G}(\lambda, u)(r) = \int_r^R \phi^{-1} \left[\frac{1}{s^{N-1}} \int_0^s \xi^{N-1} (g(|u(\xi)|) + \lambda h) d\xi \right] ds, \tag{2.62}$$

where $h > 0$ is a constant to be fixed later. We find that \mathcal{G} sends bounded sets of $[0, R] \times C_R$ into bounded sets of C_R and $\mathcal{G}(0, u) = T_0(u)$. Moreover, \mathcal{G} is a completely continuous operator.

Also, let us define the operator $\mathcal{S} : [0, R] \times C_R \rightarrow C_R$,

$$\mathcal{S}(\lambda, u) = \int_r^R \phi^{-1} \left[\frac{\lambda}{s^{N-1}} \int_0^s \xi^{N-1} g(|u(\xi)|) d\xi \right] ds. \tag{2.63}$$

Again, we see that \mathcal{S} is completely continuous and note that $\mathcal{S}(1, \cdot) = T_0$.

One proves the existence of a fixed point of T_0 , and hence of a positive solution to (2.51), by using suitable a priori estimates and degree theory. Indeed, one may show that there exist $R_1 > 0$ and $\epsilon_0 > 0$ such that

$$\text{deg}_{\text{LS}}(I - T_0, B(0, R_1), 0) = 0$$

and

$$\text{deg}_{\text{LS}}(I - T_0, B(0, \epsilon_0), 0) = 1$$

and thus, using the excision property of the Leray–Schauder degree it will follow that there must exist a solution of the equation

$$u = T_0(u)$$

in $B(0, R_1) \setminus \overline{B(0, \epsilon_0)}$.

To establish these facts, we need to prove that solutions $(\lambda, u) \in [0, R] \times C_R$ of the equation

$$u = \mathcal{G}(\lambda, u) \tag{2.64}$$

are a priori bounded. To do this one considers the auxiliary problem

$$\begin{cases} (r^{N-1}\phi(u'))' + r^{N-1}(g(|u|) + h) = 0, & r \in (0, R), \\ u'(0) = u(R) = 0. \end{cases} \tag{2.65}$$

and proves the following lemmas:

LEMMA 2.25. *There exists $h_0 > 0$ such that problem (2.65) has no solutions for $h \geq h_0$.*

PROOF. We argue by contradiction and thus assume that there exists a sequence $\{h_n\}_{n \in \mathbb{N}}$, with $h_n \rightarrow \infty$ as $n \rightarrow \infty$ such that (2.65) has a solution u_n . Then, u_n satisfies

$$\phi(u'_n(r)) = -r^{N-1} \int_0^r \xi^{N-1} (g(|u_n(\xi)|) + h_n) \, d\xi \leq 0$$

and

$$u_n(r) = \int_r^R \phi^{-1} \left[\frac{1}{s^{N-1}} \int_0^s \xi^{N-1} (g(|u_n(\xi)|) + h_n) \, d\xi \right] \, ds \geq 0.$$

Hence, $u'_n(r) \leq 0$ and $u_n(r) \geq 0$ for all $r \in [0, R]$. Also,

$$u_n(r) \geq (R - r)\phi^{-1} \left(\frac{r h_n}{N} \right), \quad \text{for all } r \in [0, R]$$

and thus, if $r \in [\frac{R}{4}, \frac{3R}{4}]$,

$$u_n(r) \geq \frac{R}{4}\phi^{-1} \left(\frac{R h_n}{4N} \right). \tag{2.66}$$

Since we also have that for $r \in [\frac{R}{4}, \frac{3R}{4}]$

$$u_n(r) \geq \int_r^{\frac{3R}{4}} \phi^{-1} \left[\frac{1}{s^{N-1}} \int_0^s \xi^{N-1} g(|u_n(\xi)|) d\xi \right] ds,$$

by (2.66), the fact that u_n is decreasing, and the second assumption in (2.54), we have, that given arbitrary $A > 0$, there exists $n_1 \in \mathbb{N}$ such that for $n \geq n_1$

$$\begin{aligned} u_n(r) &\geq \int_r^{\frac{3R}{4}} \phi^{-1} \left[\frac{A}{s^{N-1}} \int_0^s \xi^{N-1} \phi(u_n(\xi)) d\xi \right] ds \\ &\geq \int_r^{\frac{3R}{4}} \phi^{-1} \left[\frac{A}{s^{N-1}} \int_0^r \xi^{N-1} \phi(u_n(\xi)) d\xi \right] ds, \end{aligned}$$

and, since $\phi(u_n(\cdot))$ is decreasing,

$$u_n(r) \geq \int_r^{\frac{3R}{4}} \phi^{-1} \left[\frac{Ar^N}{Ns^{N-1}} \phi(u_n(r)) \right] ds.$$

Using now that $\frac{R}{4} \leq r \leq s \leq \frac{3R}{4}$, we obtain

$$\frac{Ar^N}{Ns^{N-1}} \geq dA,$$

where d is a constant. Thus, by the monotonicity of ϕ^{-1} , for all $r \in [\frac{R}{4}, \frac{R}{2}]$, we have that

$$u_n(r) \geq \frac{R}{4} \phi^{-1}(dA\phi(u_n(r))), \quad \text{for all } n \geq n_1,$$

or equivalently,

$$\frac{\phi(\frac{4}{R}u_n(r))}{\phi(u_n(r))} \geq dA, \tag{2.67}$$

for all $n \geq n_1$ and for all $r \in [\frac{R}{4}, \frac{R}{2}]$.

It is clear that (2.67) cannot hold for A large if $R \geq 4$. If $R < 4$, by (2.66), condition (2.52), and the fact that A is arbitrary, we obtain a contradiction for $n \geq n_0$ for some $n_0 \geq n_1$. □

Let us fix $h \geq h_0$, for h_0 given in Lemma 2.25, and consider the family of problems

$$\begin{cases} (r^{N-1}\phi(u'))' + r^{N-1}(g(|u|) + \lambda h) = 0, & r \in (0, R), \\ u'(0) = u(R) = 0, \end{cases} \tag{2.68}$$

for $\lambda \in [0, 1]$.

The next lemma has a lengthy proof, see [47] for the details.

LEMMA 2.26. *Solutions to (2.68) are a priori bounded.*

Let S be as defined by (2.63). In order to complete the proof of the main result of this section we need one more lemma.

LEMMA 2.27. *There exists an $\varepsilon_0 > 0$ such that the equation*

$$u = \mathcal{S}(\lambda, u) \tag{2.69}$$

has no solution (λ, u) with $u \in \partial B(0, \varepsilon_0)$ and $\lambda \in [0, 1]$.

PROOF. We argue by contradiction and thus we assume that there are sequences $\{u_n\}$ and $\{\lambda_n\}$ with $\|u_n\| = \varepsilon_n \rightarrow 0$ as $n \rightarrow \infty$ and $\lambda_n \in [0, 1]$ such that (λ_n, u_n) satisfies (2.69) for each $n \in \mathbb{N}$. We have that (λ_n, u_n) satisfies

$$u_n(r) = \int_r^R \phi^{-1} \left[\frac{\lambda_n}{s^{N-1}} \int_0^s \xi^{N-1} g(|u_n(\xi)|) d\xi \right] ds$$

which implies, by the first assumption in (2.54), that for sufficiently large n

$$\varepsilon_n \leq \phi^{-1} \left(\phi(\varepsilon_n) \frac{\mu R}{N} \right) R,$$

where μ is a positive arbitrarily small number. Thus

$$\phi \left(\frac{\varepsilon_n}{R} \right) \leq \frac{\mu R}{N} \phi(\varepsilon_n). \tag{2.70}$$

If $R \leq 1$, we immediately reach a contradiction. If now $R > 1$, let us set $\tilde{\varepsilon}_n = \varepsilon_n/R$. Then

$$\frac{\phi(R\tilde{\varepsilon}_n)}{\phi(\tilde{\varepsilon}_n)} \geq \frac{N}{\mu R},$$

and we reach a contradiction by condition (2.53) and the fact that μ is arbitrary. □

It now follows from Lemmas 2.25 and 2.26, that if u is a solution to the equation

$$u = \mathcal{G}(\lambda, u), \quad \lambda \in [0, 1],$$

then $\|u\| \leq C$, where C is a positive constant. Thus if $B(0, R_1)$ is the ball centered at 0 in C_R with radius $R_1 > C$, then we have that the Leray–Schauder degree of the operator

$$I - \mathcal{G}(\lambda, \cdot) : \overline{B(0, R_1)} \rightarrow C_R$$

is well defined for every $\lambda \in [0, 1]$. Then, by the properties of the Leray–Schauder degree, we have that

$$\text{deg}_{\text{LS}}(I - T_0, B(0, R_1), 0) = \text{deg}_{\text{LS}}(I - \mathcal{G}(1, \cdot), B(0, R_1), 0) = 0, \tag{2.71}$$

since (2.64) does not have solutions on $\{1\} \times \overline{B(0, R_1)}$. Also, by Lemma 2.27 and the properties of the Leray–Schauder degree, it follows that for $\varepsilon_0 > 0$ small enough,

$$\text{deg}_{\text{LS}}(I - \mathcal{S}(\lambda, \cdot), B(0, \varepsilon_0), 0) \text{ is constant for all } \lambda \in [0, 1].$$

Hence

$$\text{deg}_{\text{LS}}(I - T_0, B(0, \varepsilon_0), 0) = \text{deg}_{\text{LS}}(I, B(0, \varepsilon_0), 0) = 1. \tag{2.72}$$

Thus, using the excision property of the Leray–Schauder degree we conclude from (2.71) and (2.72) that there must be a solution of the equation

$$u = T_0(u)$$

with $u \in B(0, R_1) \setminus \overline{B(0, \varepsilon_0)}$. This fixed point corresponds to a nontrivial solution to (2.51), thus completing the proof of Theorem 2.23. \square

We conclude this section with a proof of the nonexistence result (Theorem 2.24) and some applications:

PROOF OF THEOREM 2.24. Assume condition (2.58) and the existence of a positive solution u of (2.51). Let

$$\Phi_*^{-1}(t) = \int_0^t \frac{\Phi^{-1}(\tau)}{\tau^{(N-1)/N}} d\tau$$

denote the Orlicz–Sobolev conjugate of Φ . Then, multiplying the equation by $ru'(r) + bu(r)$, where

$$b = \sup_{s \geq 0} \frac{NG(s)}{sg(s)},$$

one obtains (see [47])

$$\begin{aligned} & \frac{d}{dr} [r^N (\Phi_*(\phi(u'(r))) + G(u(r))) + br^{N-1}u(r)\phi(u'(r))] \\ &= r^{N-1} [(b + 1)\phi(u'(r))u'(r) - N\Phi(u'(r))] \\ & \quad + r^{N-1} [NG(u(r)) - bg(u(r))u(r)] \\ & \leq 0, \end{aligned}$$

and thus, one concludes that

$$E(r) := r^N (\Phi_*(\phi(u'(r))) + G(u(r))) + br^{N-1}u(r)\phi(u'(r))$$

is nonincreasing for $r \in [0, R]$. However, $E(0) = 0$ and $E(R) = \Phi_*(\phi(u'(R))) > 0$, which is a contradiction. □

The following two examples will serve to illustrate the above existence and nonexistence results. Consider the boundary value problem

$$\begin{cases} \operatorname{div}\left(\frac{|\nabla u|^{2p-2}\nabla u}{\sqrt{1+|\nabla u|^{2p}}}\right) + u^q = 0, & x \in B_R(0), \\ u = 0, & x \in \partial B_R(0), \end{cases} \tag{2.73}$$

for $R > 0$. In this case the function ϕ is given by

$$\phi(s) = \frac{|s|^{2p-2}s}{\sqrt{1+|s|^{2p}}}$$

and one obtains nonexistence (see (2.58)) whenever

$$q \geq \frac{N(2p-1) + 2p}{N-2p}$$

and existence whenever

$$p-1 < q < \frac{N(p-1) + p}{N-p}$$

(see Theorem 2.23).

For the boundary value problem

$$\begin{cases} \operatorname{div}\left((1+|\nabla u|^2)^{\frac{m-1}{2}}\nabla u\right) + u^q = 0, & x \in B_R(0), \\ u = 0, & x \in \partial B_R(0), \end{cases}$$

the above conditions imply the existence of positive solutions when

$$m < q < \frac{Nm + m + 1}{N - m - 1}$$

and nonexistence when

$$q \geq \begin{cases} \frac{Nm+m+1}{N-m-1}, & m > 1, \\ \frac{N+2}{N-2}, & m \leq 1. \end{cases}$$

2.3. The case when $f(0) < 0$

We now consider (2.1), i.e.,

$$\begin{cases} (r^{N-1}\phi(u'))' + \lambda r^{N-1}f(u) = 0, & 0 < r < R, \\ u'(0) = u(R) = 0, \end{cases} \tag{2.74}$$

and allow for $f(0) < 0$. In this case the problem has no trivial solution, hence bifurcation results (relative to a trivial branch of solutions) will not apply and other methods must be used.

We make the following assumptions:

(A.1) ϕ is an odd, increasing homeomorphism on \mathbb{R} , and for each $\sigma > 0$ there exists a positive number $M_\sigma > 0$ such that

$$\phi(\sigma s) \leq M_\sigma \phi(s) \tag{2.75}$$

for every $s \in \mathbb{R}$.

(A.2) $f : \mathbb{R}^+ \rightarrow \mathbb{R}$ is continuous, nondecreasing on $[B, \infty)$ for some $B > 0$, and

$$\lim_{s \rightarrow \infty} \frac{f(s)}{\phi(s)} = \infty. \tag{2.76}$$

(A.3) There exists $\theta \in (0, 1)$ such that

$$N \liminf_{s \rightarrow \infty} \frac{F(\theta s)}{sf(s)} > \max \left\{ N \limsup_{s \rightarrow \infty} \frac{\Phi(s)}{s\phi(s)} - 1, 0 \right\}, \tag{2.77}$$

where, as usual, $F(s) = \int_0^s f(t) dt$ and $\Phi(s) = \int_0^s \phi(t) dt$.

The main result in this section is:

THEOREM 2.28. *Let (A.1)–(A.3) hold and assume that ϕ^{-1} is concave on \mathbb{R}^+ . Then there exists a positive number $\bar{\lambda}$ such that for $0 < \lambda < \bar{\lambda}$, Equation (2.74) has a positive, decreasing solution u_λ with*

$$\lim_{\lambda \rightarrow 0} u_\lambda(r) = \infty \tag{2.78}$$

uniformly for r in compact subsets of $(0, R)$.

REMARK 2.29.

1. Condition (A.3) was employed in [47] to establish the existence of positive solutions to (2.74) when $f(0) = 0$.
2. In the case when $\phi(s) = |s|^{p-2}s$, (A.3) becomes

$$\liminf_{s \rightarrow \infty} \frac{F(\theta s)}{sf(s)} > \max \left(\frac{N-p}{Np}, 0 \right). \tag{2.79}$$

In particular, if $f(s) = s^q$, (2.76) and (2.77) require that

$$p - 1 < q < \frac{Np}{\max(N - p, 0)} - 1.$$

3. In the case when $\phi(s) = s$ and $N \geq 2$, the existence part of Theorem 2.28 was established in [19] under the assumptions that f is nondecreasing on \mathbb{R} and

$$\lim_{s \rightarrow \infty} \left(NF(\theta s) - \frac{N - 2}{2} sf(s) \right) \left(\frac{s}{f(s)} \right)^{N/2} = \infty, \tag{2.80}$$

for some $\theta \in (0, 1)$. Note that (2.80) can be derived from (2.79) with $p = 2$ when f is nondecreasing.

After several technical computations one proceeds to establish properties for the associated operator equations which are defined as follows. For each $v \in C[0, R]$, and $\mu \geq 0$, let $u = A_\mu v$ be the solution of

$$\begin{cases} (r^{N-1}\phi(u'))' = -\lambda r^{N-1}(f(v) + \mu), & 0 < r < R, \\ u'(0) = u(R) = 0. \end{cases} \tag{2.81}$$

Then $A_\mu : C[0, R] \rightarrow C[0, R]$ is a completely continuous operator and its fixed points u such that $u \geq w$ on $[0, R]$ will yield solutions of (2.81) and hence of (2.74). To establish the existence of such fixed points we shall list some auxiliary result, whose proofs may be found in [53].

LEMMA 2.30. *For each $\lambda > 0$, small enough, there exists a positive number R_λ with $\lim_{\lambda \rightarrow 0} R_\lambda = \infty$ such that all solutions of*

$$u = \theta A_0 u, \quad 0 \leq \theta \leq 1, \tag{2.82}$$

satisfy $\|u\| \neq R_\lambda$.

LEMMA 2.31. *There exists a positive number μ_0 (depending on λ) such that: If A_μ has a fixed point, then $\mu \leq \mu_0$.*

LEMMA 2.32. *There exists a function $H : \mathbb{R}^+ \rightarrow \mathbb{R}$ with $\lim_{d \rightarrow \infty} H(d) = \infty$ such that all solutions u of $u = A_\mu(u)$ satisfy*

$$u(r) \geq H(\|u\|)(1 - r), \quad r \in [0, 1]. \tag{2.83}$$

LEMMA 2.33. *For each $v > 0$, there exists a positive number C_v such that all solutions u of*

$$u = A_\mu(u) \tag{2.84}$$

with $\lambda \geq v$ satisfy $\|u\| < C_v$.

PROOF OF THEOREM 2.28. Using the above lemmas we obtain

$$\text{deg}_{\text{LS}}(I - A_0, B(0, C_\lambda), 0) = \text{deg}_{\text{LS}}(I - A_\mu, B(0, C_\lambda), 0) = 0, \tag{2.85}$$

where C_λ is given by Lemma 2.33. On the other hand, Lemma 2.30 implies that

$$\text{deg}_{\text{LS}}(I - A_0, B(0, R_\lambda), 0) = 1. \tag{2.86}$$

Hence it follows from the excision property of the Leray–Schauder degree that there exists a solution u_λ such that

$$R_\lambda \leq \|u_\lambda\| \leq C_\lambda.$$

Since $R_\lambda \rightarrow \infty$, as $\lambda \rightarrow 0$, it follows from Lemma 2.32 that $u_\lambda \geq 0$, for λ small. The remainder of the proof is straightforward. \square

2.4. The case when $f(0) > 0$

In this section we again consider (2.74):

$$\begin{cases} (r^{N-1}\phi(u'))' + \lambda r^{N-1}f(u) = 0, & 0 < r < R, \\ u'(0) = u(R) = 0, \end{cases} \tag{2.87}$$

and allow for $f(0) > 0$. We continue to assume the conditions (A.1)–(A.3) imposed in the previous section hold. The main theorem follows:

THEOREM 2.34. *Let (A.1)–(A.3) hold and suppose that $f(s) > 0$ for $s \geq 0$. Then there exists a positive number λ^* such that (2.74) has at least two solutions for $\lambda < \lambda^*$, at least one for $\lambda = \lambda^*$, and none for $\lambda > \lambda^*$.*

Since we are interested in positive solutions, we define $f(s) = f(0)$ if $s \leq 0$. Before proving Theorem 2.34 we outline several lemmas:

LEMMA 2.35. *There exists a positive number $\tilde{\lambda}$ such that (2.74) has no solution for $\lambda > \tilde{\lambda}$.*

PROOF. Let u be a solution of (2.74) and $r \in (0, R)$. We have

$$u(r) \geq \phi^{-1} \left[\lambda \int_0^r \tau^{N-1} f(u) \, d\tau \right] (R - r) \tag{2.88}$$

$$\geq \phi^{-1} \left[\frac{\lambda r^N}{N} \bar{f}(u(r)) \right] (R - r), \tag{2.89}$$

where $\bar{f}(u) = \inf_{s \geq u} f(s)$.

Hence

$$\frac{\phi\left(\frac{u(r)}{R-r}\right)}{\bar{f}(u(r))} \geq \frac{\lambda r^N}{N}. \tag{2.90}$$

On the other hand, since there exists a positive number ε such that $\bar{f}(x) \geq \varepsilon$ for every x , it follows that

$$u(r) \geq \phi^{-1}\left[\frac{\lambda r^N \varepsilon}{N}\right](R-r). \tag{2.91}$$

Combining the above, we reach a contradiction if λ is sufficiently large, since $\lim_{s \rightarrow \infty} \frac{\phi(s)}{f(s)} = 0$. □

LEMMA 2.36. *For each $\mu > 0$, there exists a positive constant C_μ such that all solutions u of (2.74) with $\lambda > \mu$ satisfy $\|u\| < C_\mu$.*

LEMMA 2.37. *If $\Lambda = \{\lambda > 0: (2.74) \text{ has a solution}\}$ and $\lambda^* = \sup \Lambda$, then $0 < \lambda^* < \infty$ and $\lambda^* \in \Lambda$.*

PROOF. Using the Leray–Schauder continuation theorem, it follows that there is a solution for λ small, and so $\lambda^* > 0$. Also, $\lambda^* < \infty$. We verify that $\lambda^* \in \Lambda$. Let $\{\lambda_n\} \subset \Lambda$ be such that $\lambda_n \rightarrow \lambda^*$, and let $\{u_n\}$ be the corresponding solutions of (2.74) with $\lambda = \lambda_n$. From Lemma 2.36, we deduce that $\{u_n\}$ is bounded in $C^1[0, R]$. Hence $\{u_n\}$ has a subsequence which converges to $u \in C[0, R]$. By a standard limiting process, it follows that u is a solution for (2.74) with $\lambda = \lambda^*$. □

LEMMA 2.38. *Let $0 < \lambda < \lambda^*$ and let u_{λ^*} be a solution of (2.74). Then there exists a positive number ε such that $u_{\lambda^*} + \varepsilon$ is an upper solution of (2.74).*

For $v \in C[0, R]$, let $A_\lambda v = u$ where u satisfies

$$\begin{cases} (r^{N-1}\phi(u'))' = -\lambda r^{N-1} f(v), & 0 < r < R, \\ u'(0) = u(R) = 0. \end{cases} \tag{2.92}$$

Define

$$\tilde{f}(v) = \begin{cases} f(u_{\lambda^*} + \varepsilon), & v \geq u_{\lambda^*} + \varepsilon, \\ f(v), & -\varepsilon \leq v \leq u_{\lambda^*} + \varepsilon, \\ f(0), & v \leq 0, \end{cases} \tag{2.93}$$

and let \tilde{A}_λ be the operator analogous to A_λ defined by \tilde{f} .

LEMMA 2.39. *Let u be a solution of $u = \tilde{A}_\lambda u$. Then $0 \leq u \leq u_{\lambda^*} + \varepsilon$.*

PROOF. Let u satisfy $u = \tilde{A}_\lambda u$. Then

$$\begin{cases} (r^{N-1}\phi(u'))' = -\lambda r^{N-1} f(u), & 0 < r < R, \\ u'(0) = u(R) = 0. \end{cases} \tag{2.94}$$

By the maximum principle, $u \geq 0$. We claim that $u \leq u_{\lambda^*} + \varepsilon$. Suppose that there exists $\bar{r} \in (0, R)$ such that $u(\bar{r}) > u_{\lambda^*}(\bar{r}) + \varepsilon$. Then there exists numbers r_0 and r_1 with $0 \leq r_0 < r_1 < R$ such that $u'(r_0) = u'_{\lambda^*}(r_0)$, $u(r_1) = u_{\lambda^*}(r_1) + \varepsilon$, and $u > u_{\lambda^*} + \varepsilon$ on (r_0, r_1) .

Hence

$$(r^{N-1}\phi(u'))' = -\lambda r^{N-1} f(u_{\lambda^*} + \varepsilon), \quad \text{for } r \in (r_0, r_1]. \tag{2.95}$$

Since

$$(r^{N-1}\phi(u'_{\lambda^*}))' \leq -\lambda r^{N-1} f(u_{\lambda^*} + \varepsilon), \tag{2.96}$$

we deduce that

$$[r^{N-1}(\phi(u') - \phi(u'_{\lambda^*}))]' \geq 0, \quad \text{for } r \in (r_0, r_1], \tag{2.97}$$

and so $u - (u_{\lambda^*} + \varepsilon)$ is nondecreasing on $(r_0, r_1]$.

Consequently,

$$u(r) < u_{\lambda^*}(r) + \varepsilon, \quad r \in (r_0, r_1], \tag{2.98}$$

a contradiction. □

We now summarize a proof of the main theorem:

PROOF OF THEOREM 2.34. Let $0 < \lambda < \lambda^*$. Since 0 is a lower solution and u_{λ^*} is an upper solution (see [31,66]), there exists a solution u_λ with $0 \leq u_\lambda \leq u_{\lambda^*}$. We next establish the existence of a second solution. Define

$$B = \{u \in C[0, R]: -\varepsilon \leq u \leq u_{\lambda^*} + \varepsilon\}. \tag{2.99}$$

Then B is open and $u_\lambda \in B$. Since \tilde{A}_λ is bounded for λ in compact intervals,

$$\text{deg}_{\text{LS}}(I - \tilde{A}_\lambda, B(u_\lambda, M), 0) = 1 \tag{2.100}$$

if M is sufficiently large. Here $B(u_\lambda, M)$ denotes the open ball center at u_λ with radius M in $C[0, R]$.

If there exists $u \in \partial B$ such that $u = \tilde{A}_\lambda u$ then u is a second solution. Suppose that $u \neq \tilde{A}_\lambda u$ for $u \in \partial B$. Then $\text{deg}_{\text{LS}}(I - \tilde{A}_\lambda, B, 0)$ is well defined and since \tilde{A}_λ has no fixed point in $B(u_\lambda, M) \setminus B$, we have

$$\text{deg}_{\text{LS}}(I - A_\lambda, B, 0) = \text{deg}(I - \tilde{A}_\lambda, B, 0) = 1. \tag{2.101}$$

On the other hand, it follows that

$$\deg_{\text{LS}}(I - A_\lambda, B(0, M), 0) = 0 \quad (2.102)$$

for some large number M . Hence

$$\deg_{\text{LS}}(I - A_\lambda, B(0, M) \setminus B, 0) = -1, \quad (2.103)$$

and the existence of a second solution follows. \square

3. Problems on annular domains

We now consider boundary value problems for nonlinear ordinary differential equations of the form

$$\begin{cases} (\phi(u'))' + \frac{N-1}{r}\phi(u') + f(u) = 0, & R_1 < r < R_2, \\ u(R_1) = u(R_2) = 0, \end{cases} \quad (3.1)$$

where $R_1 > 0$. The parameter λ plays no role in the considerations to follow, thus it is suppressed in Equation (3.1). We again assume $\phi: \mathbb{R} \rightarrow \mathbb{R}$ is an odd increasing homeomorphism such that for all $c > 0$, there exists $A_c > 0$, such that

$$A_c\phi(s) \leq \phi(cs), \quad \text{for } s \in \mathbb{R}^+, \quad (3.2)$$

and

$$\lim_{c \rightarrow \infty} A_c = \infty. \quad (3.3)$$

This assumption implies that there exists $B_c > 0$ such that

$$\phi(cs) \leq B_c\phi(s), \quad \text{for } s \in \mathbb{R}^+,$$

and

$$\lim_{c \rightarrow 0} B_c = 0.$$

Since the only property of the function $\frac{N-1}{r}$ we shall use here is its continuity, we will consider the more general problem

$$\begin{cases} (\phi(u'))' + b(r)\phi(u') + f(u) = 0, & R_1 < r < R_2, \\ u(R_1) = u(R_2) = 0, \end{cases} \quad (3.4)$$

where $b : [R_1, R_2] \rightarrow \mathbb{R}$ is a continuous function. The nonlinear term f will be assumed to be continuous and satisfy

$$\limsup_{s \rightarrow 0} \frac{f(s)}{\phi(s)} \leq 0 \tag{3.5}$$

and to grow superlinearly (with respect to ϕ) near infinity, i.e.,

$$\lim_{s \rightarrow \infty} \frac{f(s)}{\phi(s)} = \infty. \tag{3.6}$$

For such problems we shall establish that (3.4) always has a positive solution defined for any interval $[R_1, R_2]$. The results discussed are motivated by problems studied in [30,51, 62,73]. We remark that the results given are equally valid in case f depends upon r also, provided the assumptions made are assumed uniform with respect to r .

3.1. Fixed point formulation

Using the integrating factor

$$p(r) = e^{\int_{R_1}^r b(s) ds},$$

we may rewrite problem (3.4) equivalently as

$$\begin{cases} (p\phi(u'))' + pf(u) = 0, & R_1 < r < R_2, \\ u(R_1) = u(R_2) = 0. \end{cases} \tag{3.7}$$

The existence of solutions of (3.7) (hence (3.4)) is established by proving the existence of fixed points of a completely continuous operator $F : E \rightarrow E$, where $E = C[R_1, R_2]$, endowed with the norm $\|u\| = \max_{r \in [R_1, R_2]} |u(r)|$. The operator F is defined by the following lemma:

LEMMA 3.1. *Let ϕ be as above and let c be a given nonnegative constant. Then for each $v \in E$ the problem*

$$\begin{cases} (p\phi(u'))' - cp\phi(u) = pv, & R_1 < r < R_2, \\ u(R_1) = u(R_2) = 0, \end{cases} \tag{3.8}$$

has a unique solution $u = T(v)$, and the operator $T : E \rightarrow E$ is completely continuous.

PROOF. For each $w \in E$ let $u = B(w)$ be the unique solution of

$$\begin{cases} (p\phi(u'))' - cp\phi(w) = pv, & R_1 < r < R_2, \\ u(R_1) = u(R_2) = 0, \end{cases}$$

given by

$$u(r) = \int_{R_1}^r \phi^{-1} \left(\frac{1}{p} \left\{ q - \int_{R_1}^s p(c\phi(w) + v) \, d\xi \right\} \right) \, ds,$$

where q is the unique number such that $u(R_2) = 0$. The existence of a fixed point u of B , hence a solution u to Equation (3.8), follows from the continuation theorem of Leray–Schauder. One may then define the operator T by

$$T(v) = u,$$

where u is the solution of (3.8).

To accomplish this, assume $u \in E$ and $\lambda \in (0, 1)$ such that

$$u = \lambda B(u).$$

Then

$$\begin{cases} \left(p\phi\left(\frac{u'}{\lambda}\right) \right)' - cp\phi(u) = pv, & R_1 < r < R_2, \\ u(R_1) = u(R_2) = 0. \end{cases}$$

Multiplying the above by u and integrating we obtain

$$\int_{R_1}^{R_2} p\phi\left(\frac{u'}{\lambda}\right)u' \, dr + \int_{R_1}^{R_2} cp\phi(u)u \, dr = - \int_{R_1}^{R_2} pvu \, dr.$$

On the other hand, since ϕ is an increasing homeomorphism, for each $\epsilon > 0$, there exists a constant c_ϵ such that

$$|s| \leq \epsilon\phi(s)s + c_\epsilon, \quad \text{for } s \in \mathbb{R}.$$

Thus we obtain

$$\left| \int_{R_1}^{R_2} pvu \, dr \right| \leq \|v\| \int_{R_1}^{R_2} p|u| \, dr \leq \|v\| \left\{ \epsilon \int_{R_1}^{R_2} p\phi(u)u \, dr + c_\epsilon(R_2 - R_1) \right\},$$

and, by choosing ϵ appropriately,

$$\left| \int_{R_1}^{R_2} pvu \, dr \right| \leq \frac{1}{2}c \int_{R_1}^{R_2} (p\phi(u)u + c_1) \, dr,$$

where c_1 is a constant. Hence we obtain

$$\int_{R_1}^{R_2} p\phi\left(\frac{u'}{\lambda}\right)u' \, dr \leq c_2,$$

for a constant c_2 . Therefore

$$\int_{R_1}^{R_2} |u'| \, dr \leq c_3,$$

and hence

$$\|u\| \leq c_4.$$

Further

$$\left\| \left(p\phi\left(\frac{u'}{\lambda}\right) \right)' \right\|_{L^1} \leq c_5.$$

Since there exists r_0 such that $u'(r_0) = 0$, we obtain from the latter inequality that

$$\left| p\phi\left(\frac{u'}{\lambda}\right) \right| \leq c_6$$

and hence

$$\|u'\| \leq c_7,$$

where c_1, \dots, c_7 are constants independent of λ . The complete continuity of B is easily established and we conclude from these a priori bounds that B has a fixed point $u = T(v)$. If u_1 and u_2 are fixed points, one immediately obtains that

$$\begin{aligned} & \int_{R_1}^{R_2} p(\phi(u'_1) - \phi(u'_2))(u'_1 - u'_2) \, dr \\ & + \int_{R_1}^{R_2} cp(\phi(u_1) - \phi(u_2))(u_1 - u_2) \, dr = 0, \end{aligned}$$

and hence, since ϕ is increasing, that $u_1 = u_2$. Thus the operator T given in the statement of the lemma is well defined. □

Using Lemma 3.1 we obtain a fixed point formulation of problem (3.7) as

$$u = F(u) = T(-c\phi(u) - f(u)). \tag{3.9}$$

The next lemma is crucial for establishing the existence of nonzero fixed points of (3.9), its proof may be found in [74].

LEMMA 3.2. *If u is the solution of (3.8) with $v \leq 0$, then*

$$u(r) \geq c_0 \|u\| k(r), \quad R_1 \leq r \leq R_2,$$

where

$$k(r) = \frac{1}{R_2 - R_1} \min\{r - R_1, R_2 - r\},$$

and c_0 is a positive constant.

3.2. Existence results

We next establish the existence of a nontrivial solution of (3.7) by means of a fixed point argument, similar to those used above, (see [65,51]). We need the following auxiliary results.

PROPOSITION 3.3. *Assume that $f : \mathbb{R} \rightarrow \mathbb{R}$ is continuous and there exists a constant $c > 0$ such that*

$$f(s) + c\phi(s) \geq 0, \quad s \geq 0.$$

Further assume there exists a constant $m > 0$ such that

$$u = T(\lambda(-c\phi(|u|) - f(|u|))), \quad 0 \leq \lambda \leq 1, \quad \Rightarrow \quad \|u\| \neq m,$$

and there exists a constant $M > m$ and an element $h \in E, h \leq 0$ such that

$$u = T(-c\phi(u) - f(|u|) + \lambda h), \quad 0 \leq \lambda \leq 1, \quad \Rightarrow \quad \|u\| \neq M,$$

further any solution u of

$$u = T(-c\phi(u) - f(|u|) + h),$$

satisfies $\|u\| > M$. Then there exists a fixed point $u \in E$ of the operator $F, F(u) = T(-c\phi(|u|) - f(|u|))$ such that

$$m < \|u\| < M.$$

Applying this proposition to the boundary value problem (3.7), we have the following corollary.

COROLLARY 3.4. *Assume that $f : \mathbb{R} \rightarrow \mathbb{R}$ is continuous and there exists a constant $c > 0$ such that*

$$f(u) + c\phi(u) \geq 0, \quad u \geq 0.$$

Further assume there exists a constant $m > 0$ such that for $0 \leq \lambda \leq 1$ and any solution u of

$$\begin{cases} (p\phi(u'))' - cp\phi(u) + \lambda(cp\phi(|u|) + pf(|u|)) = 0, & R_1 < r < R_2, \\ u(R_1) = u(R_2) = 0, \end{cases} \quad (3.10)$$

satisfies

$$\|u\| \neq m,$$

and there exists a constant $M > m$ and an element $h \in E$, $h \geq 0$ such that any solution u of

$$\begin{cases} (p\phi(u'))' - p\phi(u) + p\phi(|u|) + pf(|u|) \leq 0, & R_1 < r < R_2, \\ u(R_1) = u(R_2) = 0, \end{cases} \quad (3.11)$$

satisfies $\|u\| \neq M$, and solutions u of

$$\begin{cases} (p\phi(u'))' - p\phi(u) + p\phi(|u|) + pf(|u|) + ph = 0, & R_1 < r < R_2, \\ u(R_1) = u(R_2) = 0, \end{cases} \quad (3.12)$$

satisfy $\|u\| > M$. Then there exists a solution u , $u \geq 0$ of (3.9) (hence (3.7)) such that

$$m < \|u\| < M.$$

We next impose conditions on f and further conditions on ϕ in order that the above corollary may be applied. These are conditions about the behavior of the functions near zero and near infinity. These conditions in turn will provide the validity of Corollary 3.4 and hence yield the existence of nontrivial solutions.

PROPOSITION 3.5. *Assume that $f : \mathbb{R} \rightarrow \mathbb{R}$ is continuous and let there exist a constant $c \geq 0$ such that*

$$f(u) + c\phi(u) \geq 0, \quad u \geq 0.$$

Further, let ϕ be an odd increasing homeomorphism of \mathbb{R} which satisfies (3.2) and assume (3.5) holds. Then there exists a positive number m such that for $0 \leq \lambda \leq 1$ and any solution u of

$$\begin{cases} (p\phi(u'))' - cp\phi(u) + \lambda(pf(|u|) + cp\phi(|u|)) = 0, & R_1 < r < R_2, \\ u(R_1) = u(R_2) = 0, \end{cases}$$

satisfies $\|u\| \neq m$.

PROOF. First note that solutions are nonnegative. Following an indirect argument, assume the existence of sequences $\{\lambda_n\} \subset [0, 1]$, $\{\epsilon_n\}$, $\epsilon_n \searrow 0$, $\{u_n\}$, $\|u_n\| = \epsilon_n$, such that the triple $(\epsilon_n, \lambda_n, u_n)$ is a solution. Since each $u_n \neq 0$ has a maximum point, say $u_n(r_n^*) = \|u_n\|$, we obtain by integration

$$u'_n(r) \leq \phi^{-1} \left(\frac{\lambda_n}{p(r)} \int_r^{r_n^*} p(s) f(u_n(s)) \, ds \right)$$

and hence, for given $\epsilon > 0$ we have for large n

$$u'_n(r) \leq \phi^{-1} \left(\frac{\lambda_n}{p(r)} \int_r^{r_n^*} \epsilon p(s) \phi(u_n(s)) \, ds \right), \quad r \leq r_n^*.$$

Integrating once more and using the fact that the integrand is positive and that ϕ^{-1} is monotone, we obtain

$$\|u_n\| \leq \int_{R_1}^{R_2} \left(\phi^{-1} \left(\frac{1}{p(r)} \int_{R_1}^{R_2} \epsilon p(s) \phi(u_n(s)) \, ds \right) \right) dt,$$

hence for all large n

$$\|u_n\| \leq (R_2 - R_1) \phi^{-1}(c_1 \epsilon \phi(\epsilon_n)),$$

or

$$\phi \left(\frac{\epsilon_n}{R_2 - R_1} \right) \leq c_1 \epsilon \phi(\epsilon_n).$$

Therefore, if $R_2 - R_1 \leq 1$ we obtain a contradiction for ϵ small, on the other hand if $R_2 - R_1 > 1$, then we obtain a contradiction via (3.3). □

The following proposition from [74] cites conditions that guarantee the validity of the second part of Corollary 3.4:

PROPOSITION 3.6. *Assume that $f : \mathbb{R} \rightarrow \mathbb{R}$ is continuous and let there exist a constant $c \geq 0$ such that*

$$f(u) + c\phi(u) \geq 0, \quad u \geq 0.$$

Further, let ϕ be an odd increasing homeomorphism of \mathbb{R} that satisfies (3.2) and (3.6). Then there exists a positive number M such that any solution u of

$$\begin{cases} (p\phi(u'))' - cp\phi(u) + cp\phi(|u|) + pf(|u|) \leq 0, & R_1 < r < R_2, \\ u(R_1) = u(R_2) = 0 \end{cases}$$

satisfies $\|u\| \neq M$.

In order to apply Corollary 3.4 to Equation (3.4), we need one further result from [74]:

PROPOSITION 3.7. *Assume the hypotheses of Proposition 3.6 and let M be a constant whose existence is guaranteed there. Then there exists $h \in E, h \geq 0$ such that $\|u\| > M$ for any solution of*

$$\begin{cases} (p\phi(u'))' - cp\phi(u) + cp\phi(|u|) + pf(|u|) + ph = 0, & R_1 < r < R_2, \\ u(R_1) = u(R_2) = 0. \end{cases}$$

Combining the above propositions and using Corollary 3.4 we have the following theorem.

THEOREM 3.8. *Assume that $f : \mathbb{R} \rightarrow \mathbb{R}$ is continuous. Further, let ϕ be an odd increasing homeomorphism of \mathbb{R} which satisfies (3.2), and let the following conditions hold:*

$$-\infty < \liminf_{u \rightarrow 0} \frac{f(u)}{\phi(u)} \leq \limsup_{u \rightarrow 0} \frac{f(u)}{\phi(u)} \leq 0,$$

$$\lim_{u \rightarrow \infty} \frac{f(u)}{\phi(u)} = \infty.$$

Then the boundary value problem (3.4) has a positive solution.

Note that the existence of a constant $c \geq 0$ such that

$$f(u) + c\phi(u) \geq 0, \quad u \geq 0$$

follows from the assumptions of the theorem.

If $f : \mathbb{R} \rightarrow \mathbb{R}$ is nonnegative, then the following theorem applies.

THEOREM 3.9. *Assume that $f : \mathbb{R} \rightarrow \mathbb{R}$ is continuous and nonnegative. Further, let ϕ be an odd increasing homeomorphism of \mathbb{R} such that $\frac{\phi(u)}{u}$ is nondecreasing on \mathbb{R}^+ and satisfies (3.2); also let the following conditions hold:*

$$\liminf_{s \rightarrow 0} \frac{F(s)}{\Phi(s)} = 0,$$

$$\lim_{s \rightarrow \infty} \frac{f(s)}{\phi(s)} = \infty.$$

Then the boundary value problem (3.4) has a positive solution.

We note that in the case $\phi(s) = |s|^{p-2}s$ the conditions above hold if and only if $p \geq 2$.

3.3. Positone problems

In this section we are interested in the existence and multiplicities of positive solutions of the boundary value problem

$$\begin{cases} (\phi(u'))' + \lambda f(r, u) = 0, & R_1 < r < R_2, \\ u(R_1) = u(R_2) = 0, \end{cases} \tag{3.13}$$

with $f : [R_1, R_2] \times [0, \infty) \rightarrow (0, \infty)$ continuous. As usual, we assume ϕ is an odd increasing homeomorphism on \mathbb{R} such that

$$\limsup_{x \rightarrow \infty} \frac{\phi(\sigma x)}{\phi(x)} < \infty, \quad \text{for all } \sigma > 0. \tag{3.14}$$

Concerning f we also assume there exists $[c, d] \subset (R_1, R_2)$, $c < d$, such that

$$\lim_{s \rightarrow \infty} \frac{f(r, s)}{\phi(s)} = \infty, \quad \text{uniformly for } r \in [c, d]. \tag{3.15}$$

The main result in this section is:

THEOREM 3.10. *Let (3.14) and (3.15) hold. Then there exists a positive number λ^* such that the problem (3.13) has at least two positive solutions for $0 < \lambda < \lambda^*$, at least one for $\lambda = \lambda^*$ and none for $\lambda > \lambda^*$.*

Note that in the special case where $\phi(u') = u'$, Theorem 3.10 is classical (see, e.g., [30,100]). Related results for the case $\phi(u') = |u'|^{p-2}u'$ can be found in [33,62], and the references in these papers.

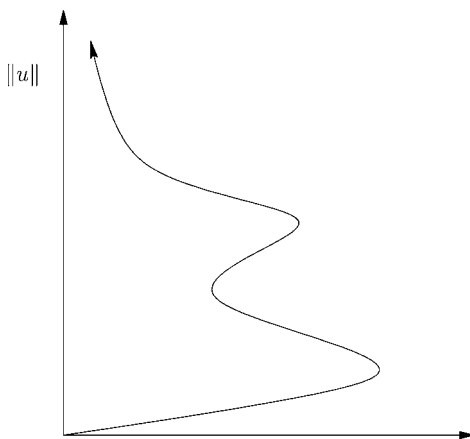

Fig. 3. Continua suggested by Theorem 3.10.

We remark here that the above formulation includes the study of positive radial solutions of equations like

$$\operatorname{div}(|\nabla u|^{p-2}\nabla u) + \lambda g(|x|, u) = 0, \quad R_1 < |x| < R_2$$

on annular domains, via the change of variables

$$t = \left(\frac{|N - p|}{(p - 1)r} \right)^{\frac{N-p}{p-1}}, \quad r = |x|,$$

and

$$f(t, u) = \left(\frac{(p - 1)r}{|N - p|} \right)^{\frac{p(N-1)}{p-1}} g \left(\frac{|N - p|}{(p - 1)} t^{-\frac{p-1}{N-p}}, u \right)$$

and thus, higher-dimensional problems, as well (see [31]).

To prove Theorem 3.10, one employs, in addition to continuation methods, also upper and lower solution methods. These methods are, of course, standard for semilinear equations (see [99,39]) and we refer to [12,31,66], where similar types of theorems for the nonlinear case are presented.

Since we are interested in nonnegative solutions we shall make the convention that $f(r, u) = f(r, 0)$ if $u < 0$. To prove Theorem 3.10 we first need a lemma which is a special case of Lemma 3.2:

LEMMA 3.11. *Let $v \in C[R_1, R_2]$ with $v \leq 0$ and let u satisfy*

$$\begin{aligned} (\phi(u'))' &= v, \\ u(R_1) &= u(R_2) = 0. \end{aligned}$$

Then

$$u(t) \geq \|u\| p(t), \quad t \in [R_1, R_2],$$

where

$$p(t) = \frac{\min(t - R_1, R_2 - t)}{R_2 - R_1}.$$

The next sequence of lemmas allows the use of continuation methods:

LEMMA 3.12. *Suppose that $g : [R_1, R_2] \times \mathbb{R}^+ \rightarrow \mathbb{R}^+$ is continuous and there exists a positive number M and an interval $[a_1, b_1] \subset (R_1, R_2)$ such that*

$$g(r, s) \geq M(\phi(s) + 1), \quad r \in [a_1, a_2], \quad s \geq 0.$$

Then there exists a positive number $M_0 = M_0(\phi, a_1, b_1)$ such that the problem

$$\begin{aligned}(\phi(u'))' &= -g(r, u), \\ u(R_1) &= 0 = u(R_2)\end{aligned}$$

has no solution whenever $M \geq M_0$.

PROOF. Let u be a solution. Then

$$u(t) = \int_{R_1}^t \phi^{-1} \left[c - \int_{R_1}^s g(\tau, u) \, d\tau \right] ds,$$

where $c = \phi(u'(R_1))$. Let $\|u\| = u(t_0)$, $t_0 \in [R_1, R_2]$. Then $u'(t_0) = 0$ and hence

$$u(t) = \int_{R_1}^t \phi^{-1} \left[\int_s^{t_0} g(\tau, u) \, d\tau \right] ds.$$

If $t_0 \geq \frac{a_1+b_1}{2}$, then

$$\begin{aligned}\|u\| &\geq u(a_1) > \int_{R_1}^{a_1} \phi^{-1} \left[M \int_{a_1}^{\frac{a_1+b_1}{2}} (\phi(u) + 1) \right] \\ &> (a_1 - R_1) \phi^{-1} \left[M \frac{(b_1 - a_1)}{2} [\phi(\|u\|\delta) + 1] \right]\end{aligned}$$

where

$$\delta = \min_{a_1 \leq t \leq b_1} p(t).$$

This implies

$$\phi\left(\frac{\|u\|}{a_1 - R_1}\right) > M \frac{(b_1 - a_1)}{2} [\phi(\|u\|\delta) + 1].$$

If $t_0 \leq \frac{a_1+b_1}{2}$, then since

$$u(t) = \int_t^{R_2} \phi^{-1} \left[\int_{t_0}^s g(\tau, u) \, d\tau \right] ds,$$

we deduce

$$\phi\left(\frac{\|u\|}{R_2 - b_1}\right) > \frac{M(b_1 - a_1)}{2} [\phi(\|u\|\delta) + 1].$$

Combining the above, we obtain

$$\phi(\gamma \|u\|) > \frac{M(b_1 - a_1)}{2} [\phi(\|u\|\delta) + 1],$$

where $\gamma = \max(\frac{1}{R_2 - b_1}, \frac{1}{a_1 - R_1})$. Consequently,

$$\|u\| > \frac{1}{\gamma} \phi^{-1} \left[\frac{M(b_1 - a_1)}{2} \right]$$

and

$$\frac{\phi(\gamma \|u\|)}{\phi(\delta \|u\|)} > \frac{M}{2} (b_1 - a_1)$$

a contradiction, if M is sufficiently large. □

It follows from the above proof, that the problem in Lemma 3.12 has no solution u satisfying

$$g(t, u(t)) \geq M(\phi(u(t)) + 1), \quad t \in [a_1, a_2],$$

if $M \geq M_0$.

These considerations further imply the following result:

THEOREM 3.13. *There exists a positive number $\bar{\lambda}$ such that problem (3.13) has no solution for $\lambda > \bar{\lambda}$.*

It follows immediately from (3.15) that there exists a constant $\mu > 0$ such that

$$f(r, s) \geq \mu(\phi(s) + 1), \quad s \in \mathbb{R}^+, \quad c \leq r \leq d.$$

Hence the result follows from the previous lemma. We also need the following lemma.

LEMMA 3.14. *For each $\mu > 0$, there exists a positive constant C_μ such that the problem*

$$\begin{cases} (\phi(u'))' = -\lambda\theta f(r, u) - (1 - \theta)M_0(|\phi(u)| + 1), \\ u(R_1) = u(R_2) = 0 \end{cases}$$

with $\lambda \geq \mu$, $\theta \in [0, 1]$ and M_0 given by Lemma 3.12, has no solution satisfying $\|u\| > C_\mu$.

Now, let Λ be the set of all $\lambda > 0$ such that (3.13) has a solution and let $\lambda^* = \sup \Lambda$.

LEMMA 3.15. $0 < \lambda^* < \infty$ and $\lambda^* \in \Lambda$.

PROOF. A function $u \in C[R_1, R_2]$ is a solution if and only if $u = F(\lambda, u)$, where

$$F : [0, \infty) \times C[R_1, R_2] \rightarrow C[R_1, R_2]$$

is the completely continuous mapping given by

$$u = F(\lambda, v),$$

with u the solution of

$$\begin{cases} (\phi(u'))' = -\lambda f(r, v), \\ u(R_1) = u(R_2) = 0. \end{cases}$$

We note that $F(0, v) = 0, v \in C[R_1, R_2]$. Hence it follows from the continuation theorem of Leray–Schauder that there exists a solution continuum $\mathcal{C} \subset [0, \infty) \times C[R_1, R_2]$ of solutions of (3.13) which is unbounded in $[0, \infty) \times C[R_1, R_2]$, and thus, (3.13) has a solution for $\lambda > 0$ sufficiently small, and hence $\lambda^* > 0$. By Theorem 3.13, $\lambda^* < \infty$. We verify that $\lambda^* \in \Lambda$. Let $\{\lambda_n\} \subset \Lambda$ be such that $\lambda_n \rightarrow \lambda^*$ and let $\{u_n\}$ be the corresponding solutions. We easily see that $\{u_n\}$ is bounded in $C^1[R_1, R_2]$ and hence $\{u_n\}$ has a subsequence converging to $u \in C[R_1, R_2]$. By standard limiting procedures, it follows that u is a solution of (3.13). □

LEMMA 3.16. *Let $0 < \lambda < \lambda^*$ and let u_{λ^*} be a solution of (3.13). Then there exists $\epsilon_0 > 0$ such that $u_{\lambda^*} + \epsilon, 0 \leq \epsilon \leq \epsilon_0$, is an upper solution of (3.13).*

Theorem 3.10 now follows from these lemmas:

PROOF OF THEOREM 3.10. Let $0 < \lambda < \lambda^*$. Since 0 is a lower solution and u_{λ^*} is an upper solution, there exists a minimum solution u_λ of (3.13) with $0 \leq u_\lambda \leq u_{\lambda^*}$. We next establish the existence of a second solution.

The mapping

$$\lambda \mapsto u_\lambda, \quad 0 \leq \lambda \leq \lambda^*,$$

where u_λ is the minimal solution of (3.13), is a continuous mapping $[0, \lambda^*] \rightarrow C[R_1, R_2]$. Hence

$$\{(\lambda, u_\lambda): 0 \leq \lambda \leq \lambda^*\} \subset \mathcal{C},$$

where \mathcal{C} is the continuum in the proof of Lemma 3.15. Using separation results on closed sets in compact metric spaces (i.e., Whyburn’s lemma [1]), one may use the arguments used in the above proof to verify that for each $\lambda \in (0, \lambda^*)$ there are at least two solutions on the continuum \mathcal{C} . □

We will discuss consequences of these existence theorems for Gelfand type problems in the next section.

4. The Liouville–Gelfand equation — A case study

4.1. Introduction

The classical Liouville–Gelfand problem is concerned with positive solutions of the equation

$$\begin{cases} \Delta u + \lambda e^u = 0, & x \in \Omega, \\ u = 0, & x \in \partial\Omega, \end{cases} \quad (4.1)$$

for $\lambda > 0$. Equation (4.1) arises in many settings, including the study of combustible gas dynamics [11,49,40], astrophysics [20,38], and prescribed curvature problems [8,63,5].

Let us briefly outline the connection with chemical kinetics. Systems such as

$$\begin{cases} (c_i)_t = k_i \Delta c_i + f_i(c_1, \dots, c_m, T), \\ T_t = k \Delta T + f(c_1, \dots, c_m, T), \end{cases} \quad (4.2)$$

arise in the theory of chemical reaction kinetics, where the c_i represent various chemical concentrations with diffusion coefficients k_i , T is the temperature, and f_i represent various nonlinear reactions. This model does not include other important effects such as convection. Assuming a constant concentration c_0 over a short time interval and that the temperature does not exceed a base temperature T_0 the equation for T in (4.2) can be reduced to (see, e.g., [52,11,40,96])

$$u_t = k_0 \Delta u + \hat{\lambda} e^{u/(1-\epsilon u)}, \quad (4.3)$$

for an appropriately nondimensionalized temperature u . Here

$$\hat{\lambda} = \frac{a_0 q_0 c_0}{T_0^2} e^{-a_0/T_0},$$

where a_0 is the activation energy of the substance, q_0 is the latent heat of the reaction, and $\epsilon = T_0/a_0$. Of particular interest is the existence of steady state solutions to (4.3):

$$\Delta u + \lambda e^{u/(1-\epsilon u)} = 0, \quad (4.4)$$

where $\lambda = \hat{\lambda}/k_0$. Equation (4.4) is known as the Arrhenius equation. In the limit of infinitely large activation energy (for a fixed temperature T_0) one obtains the Frank-Kamenetskii approximation

$$\Delta u + \lambda e^u = 0, \quad (4.5)$$

which is also known as the Liouville–Gelfand equation. Of particular importance in this setting is the existence of values of λ for which a solution to (4.5) or (4.4) will exist. It is perhaps not surprising that for large λ (4.5) has no solution (corresponding to blow-up in the parabolic problem). On the other hand, the structure of the solution set to (4.5) for small λ is quite surprising. In the next two sections we discuss this structure as well as its extension to the quasilinear case.

4.2. Solution set for the semilinear case

In this section we consider the radial version of the Liouville–Gelfand equation (4.1) with Dirichlet boundary conditions:

$$\begin{cases} u'' + \frac{N-1}{r}u' + \lambda e^u = 0, & r \in (0, 1), \\ u'(0) = u(1) = 0. \end{cases} \tag{4.6}$$

To build intuition let us consider carefully the case $N = 1$:

$$\begin{cases} u'' + \lambda e^u = 0, & r \in (0, 1), \\ u'(0) = u(1) = 0. \end{cases} \tag{4.7}$$

Multiplying by u' and integrating one finds

$$u'(r) = -\sqrt{2\lambda(e^\alpha - e^u)},$$

where $\alpha = u(0)$ is a free parameter. A second integration yields the implicit solution

$$\tanh^{-1}(\sqrt{1 - e^u/e^\alpha}) = \frac{r}{2}\sqrt{2\lambda e^\alpha} + C. \tag{4.8}$$

The condition at $r = 0$ implies $C = \tanh^{-1}(0) = 0$. Thus

$$u(r) = \alpha - 2 \ln \cosh\left(\frac{r}{2}\sqrt{2\lambda e^\alpha}\right), \quad 0 \leq r < 1. \tag{4.9}$$

From this equation we can determine for each α if there exists a value of λ for which the boundary condition $u(1) = 0$ holds. Indeed from (4.8) at $r = 1$ we conclude

$$\lambda = \frac{1}{2e^\alpha} \left[\ln\left(\frac{1 + \sqrt{1 - e^{-\alpha}}}{1 - \sqrt{1 - e^{-\alpha}}}\right) \right]^2. \tag{4.10}$$

For each α , Equation (4.10) clearly defines a value of λ for which (4.6) has a solution. It is somewhat surprising though that the right-hand side of Equation (4.10) is nonmonotone. Indeed, Figure 4 shows that there exists a unique λ for which (4.6) has exactly one solution and for each smaller λ , Equation (4.6) has precisely two solutions. In terms of the physical setting, it can be shown that for a given λ the solution with larger α value is unstable [11].

The case $N = 2$ can be solved by the change of variables $r = e^{-t}$ and $v(t) = u(r) - 2t$ to obtain $v'' + \lambda e^v = 0$, thus $u(r) = \alpha - 2 \ln(1 + \lambda/8e^\alpha r^2)$. In this case

$$\lambda = 8(e^{\alpha/2} - e^{-2\alpha}).$$

A plot of this relation is qualitatively exactly like Figure 4, now with a maximum at $\lambda = 2$. Thus for both $N = 1$ and $N = 2$ the solution set to Equation (4.6) has the same structure,

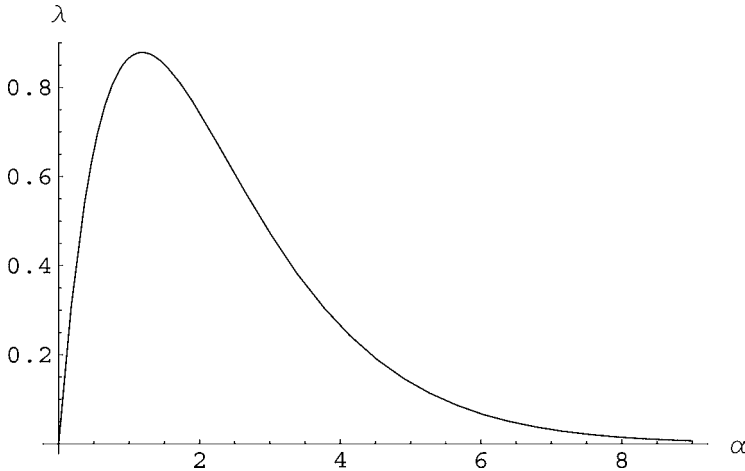

Fig. 4. The dependence of λ on α for (4.10).

there exists a λ^* such that (1.2) has a unique solution for $\lambda = \lambda^*$ and exactly two solutions for each $\lambda \in (0, \lambda^*)$.

Analytic solutions of (4.6) in the physically important case of $N = 3$ are unknown. Based on the results for $N = 1$ and $N = 2$, one might expect a similar solution structure. Historically, Emden [38], Frank-Kamenetskii [40], and Chandrasekhar [20] each numerically integrated (4.6), with Frank-Kamenetskii finding the maximal $\lambda^* \approx 3.32$. However, in [49], Gelfand showed that the structure of the solution set for $N = 3$ is quite different. The key difference is that for $N = 3$, the differential equation in (4.6) has a singular solution $\Phi(r) = -2 \ln r$, corresponding to $\lambda = 2$, which also satisfies the boundary condition $u(1) = 0$. Further, as r ranges from 1 to 0, $\Phi(r)$ ranges from 0 to ∞ . One can use this structure to transform (4.6) to a state-space where time is represented by $\Phi(r)$. With this motivation, consider the change of variables

$$\begin{cases} s = -\ln r, & 0 < r \leq 1, \\ v = \frac{du}{ds}, \\ w = \lambda e^{-2s} e^u. \end{cases} \tag{4.11}$$

Under this transformation, a solution pair $(\lambda, u_\lambda(r))$ to (4.6) is equivalent to a trajectory $\{(w(s), v(s))\}$ in the phase plane of the system

$$\begin{cases} \frac{dw}{ds} = w(v - 2), \\ \frac{dv}{ds} = v - w, \end{cases} \tag{4.12}$$

with

$$w(0) = \lambda, \tag{4.13}$$

$$v(0) = -u'_\lambda(1), \tag{4.14}$$

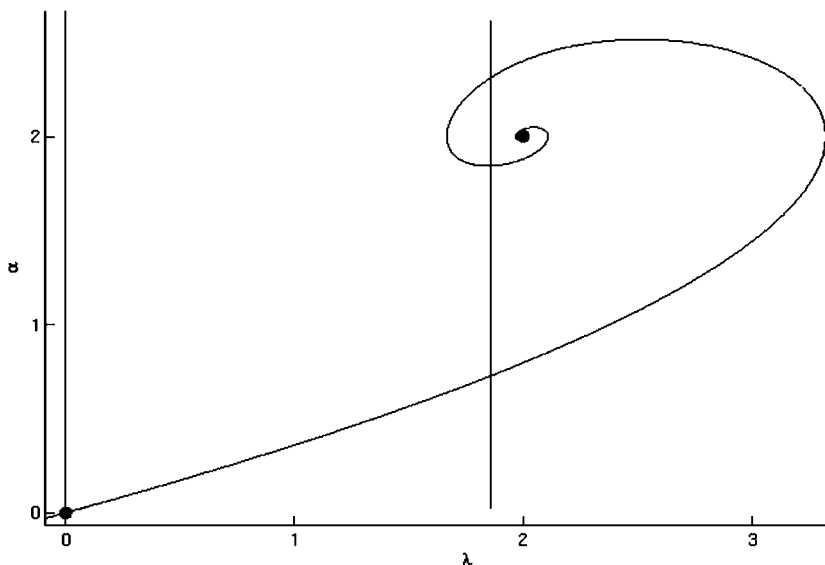

Fig. 5. Heteroclinic orbit for (4.12). The line corresponds to a value of λ for which (4.6) has three solutions.

$$w(\infty) = 0, \tag{4.15}$$

$$v(\infty) = 0. \tag{4.16}$$

An elementary analysis of the system (4.12) shows that there are two equilibrium points $(0, 0)$ and $(2, 2)$, the latter corresponding to the singular solution $\Phi(r)$. Furthermore there is a heteroclinic orbit connecting the spiral node $(2, 2)$ to the origin. Thus each intersection of this orbit with a vertical line $w = \lambda > 0$ corresponds to a solution pair $\{(\lambda, u_\lambda)\}$ of (4.6) (see Figure 5).

Thus, in contrast to the case $N = 1, 2$, for $N = 3$, given any $m \in \mathbb{N}$, there exists values of λ such that (4.6) has exactly m solutions. Moreover, for $\lambda = 2$ it has infinitely many solutions. In the context of Emden and Chandrasekhar’s isothermal gas stars, it implies the existence of infinitely many equilibrium positions.

Joseph and Lundgren observed that the change of variables above determines the structure of the solution set to (4.6) for all N . In particular, for $N > 2$, the transformation (4.11) produces the equivalent system

$$\begin{cases} \frac{dw}{ds} = w(v - 2), \\ \frac{dv}{ds} = (N - 2)v - w, \end{cases} \tag{4.17}$$

with conditions (4.13)–(4.16). For $2 < N < 10$ the equilibrium point $(2(N - 2), 2)$ is a spiral node, thus for this range of N Equation (4.6) has a solution set similar to that of $N = 3$. For $N \geq 10$ the critical point becomes a repelling node, which implies that (4.6) has a unique solution for each $\lambda \in (0, 2(N - 2))$. Thus we have demonstrated the following theorem:

THEOREM 4.1. Consider Equation (4.6). The following existence results hold:

- Case I: $1 \leq N \leq 2$. There exists $\lambda^* > 0$ such that (4.6) has exactly one solution for $\lambda = \lambda^*$ and exactly two solutions for each $\lambda \in (0, \lambda^*)$.
- Case II: $2 < N < 10$. Equation (4.6) has an unbounded continuum of solutions which oscillates around the line $\lambda = 2(N - 2)$, with the amplitude of oscillations tending to zero, as $u(0) = \|u\| \rightarrow \infty$.
- Case III: $N \geq 10$. Equation (4.6) has a unique solution for each $\lambda \in (0, 2(N - 2))$ and no solutions for $\lambda \geq 2(N - 2)$. Moreover, $\|u\| \rightarrow \infty$ as $\lambda \rightarrow 2(N - 2)$.

Finer analysis of the radial solutions to (1.2) may be found in [11,78,82,79]. For results on the Liouville–Gelfand problem on annuli, star-shaped, and more general domains see [11,80,81,107,26,42].

4.3. Solution set for the quasilinear case

In this section we discuss extensions of the Liouville–Gelfand problem. The first work in this direction is due to García Azorero and Peral Alonso [44] for the nonlinear diffusive extension:

$$\begin{cases} \Delta_p u + \lambda e^u = 0, & x \in \Omega, \\ u = 0, & x \in \partial\Omega, \end{cases} \tag{4.18}$$

for a bounded domain Ω . Using variational methods they prove the following theorem extending the case $p = 2$ (see, e.g., [26,42]):

THEOREM 4.2. For each $p > 1$ there exists a constant λ_p such that Equation (4.18) has, for $\lambda \in (0, \lambda_p)$, at least one solution for $p < N$ and at least two solutions for $p \geq N$.

Additional progress for general domains can be found in [6,104].

Studies of (4.18) in the radial case for $p \neq 2$ first appeared in [6] ($1 < p < N$) and [22] ($p = N$). In particular the paper [6] found a “transition” from infinitely many solutions ($p < N < p^2 + 3p/(p - 1)$) to unique solutions ($N \geq p^2 + 3p/(p - 1)$) that extends the Joseph–Lundgren theory. Moreover, in [22] for $p = N$ they find the existence of a $\lambda^* > 0$ such that the radial case of (4.18) has exactly one solution for $\lambda = \lambda^*$ and exactly two solutions for $\lambda \in (0, \lambda^*)$, again extending the Joseph–Lundgren theory.

In [57], the author considers a Monge–Ampère version of the Liouville–Gelfand equation defined by

$$\begin{cases} \det D^2 u + \lambda e^u = 0, & x \in \Omega, \\ u = 0, & x \in \partial\Omega, \end{cases} \tag{4.19}$$

on a strictly convex bounded domain Ω . Curiously, unlike the Joseph–Lundgren theory, in the Monge–Ampère case it was shown that there exists a λ^* such that (4.19) has at least two solutions for each $\lambda \in (0, \lambda^*)$, independent of the value of N .

Equation (4.19) is one of a family of equations

$$\begin{cases} S_k(D^2u) + \lambda e^u = 0, & x \in \Omega, \\ u = 0, & x \in \partial\Omega, \end{cases} \tag{4.20}$$

where $S_k(D^2u)$ is the k -Hessian operator discussed in the introduction. The first result for (4.20) ($k > 1$) in the radial case was due to Clément et al. [22] where they considered the case $k = n$ in \mathbb{R}^{2n} . They found that in this case (4.20) has the same twofold multiplicity of solutions as in the case $k = 1, N = 2$. This motivated the work [58] which determined the precise multiplicity of (4.20) in the radial case. Using the transformation (4.11) with $s = -k \ln r$ one finds the equivalent system:

$$\begin{cases} \frac{dw}{ds} = w(v - 2), \\ \frac{dv}{ds} = \left[\frac{N-2k}{k^2} \right] v - \frac{1}{k^{k+2}} w v^{1-k}, \end{cases} \tag{4.21}$$

with the additional conditions

$$w(0) = \lambda, \quad v(0) = -u'(1)/k, \quad w(\infty) = 0, \quad v(\infty) = 0.$$

An analysis of the system (4.21) determines the exact multiplicity of solutions to (4.20). Note that we recover the system (4.12) when $k = 1$.

In [59] all of these multiplicity results were extended to the class of quasilinear equations defined by

$$\begin{cases} r^{-\gamma} (r^\alpha |u'|^\beta u')' + \lambda e^u = 0, & r \in (0, 1), \\ u > 0, & r \in (0, 1), \\ u'(0) = u(1) = 0, \end{cases} \tag{4.22}$$

where the inequalities

$$\alpha \geq 0, \tag{4.23}$$

$$\gamma + 1 > \alpha, \tag{4.24}$$

$$\beta + 1 > 0, \tag{4.25}$$

hold. For instance, the following operators are included in this class:

Operator	α	β	γ
Laplacian	$N - 1$	0	$N - 1$
p -Laplacian ($p > 1$)	$N - 1$	$p - 2$	$N - 1$
k -Hessian	$N - k$	$k - 1$	$N - 1$

In this setting the transformation

$$\begin{cases} s = \xi \ln r, \\ v = -\frac{du}{ds}, \\ w = \lambda_0 e^{\delta s} e^u, \end{cases}$$

where $\xi = \gamma + 1 - \alpha$ and $\delta = \frac{\gamma + \beta - \alpha + 2}{\xi}$ yield the system

$$\begin{cases} \dot{w} = w(\delta - v), \\ \dot{v} = \left(\frac{\beta + 1 - \alpha}{\xi(\beta + 1)}\right)v + \left(\frac{1}{(\beta + 1)\xi^{\beta + 2}}\right)wv^{-\beta} \end{cases} \quad (4.26)$$

with the additional conditions

$$w(0) = \lambda_0, \quad v(0) = -u'(1)/\xi, \quad w(-\infty) = 0, \quad v(-\infty) = 0.$$

The analysis in [59] yields the following structure theorem for (4.22):

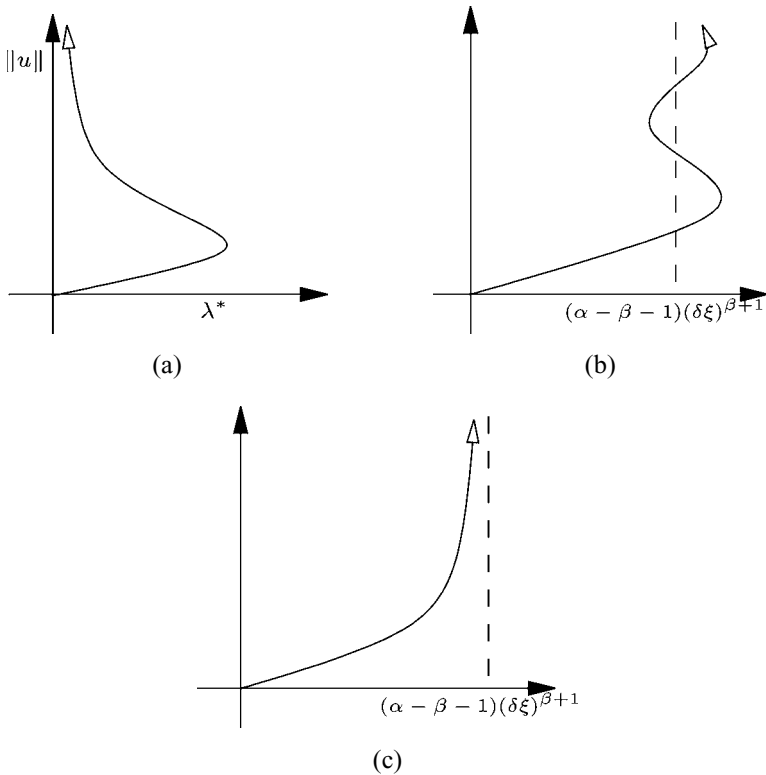

Fig. 6. Illustration of Theorem 4.3. (a) $\alpha - \beta - 1 \leq 0$, (b) $0 < \alpha - \beta - 1 < \frac{4\delta\xi}{\beta + 1}$, (c) $\frac{4\delta\xi}{\beta + 1} \leq \alpha - \beta - 1$.

THEOREM 4.3. *Consider Equation (4.22) with the inequalities (4.23), (4.24), and (4.25) satisfied. The solution structure to (4.22) is as follows (see Figure 6):*

- *Case I: $\alpha - \beta - 1 \leq 0$. There exists a unique $\lambda^* > 0$ such that (4.22) has exactly one solution for $\lambda = \lambda^*$ and exactly two solutions for $0 < \lambda < \lambda^*$.*
- *Case II: $0 < \alpha - \beta - 1 < \frac{4\delta\xi}{\beta+1}$. Equation (4.22) has a continuum of solutions which oscillates around the line $\lambda = (\alpha - \beta - 1)(\delta\xi)^{\beta+1}$, with the amplitude of oscillations tending to zero as $\|u\| \rightarrow \infty$.*
- *Case III: $\alpha - \beta - 1 \geq \frac{4\delta\xi}{\beta+1}$. Equation (4.22) has a unique solution for each $\lambda \in (0, (\alpha - \beta - 1)(\delta\xi)^{\beta+1})$ and no solutions for $\lambda \geq (\alpha - \beta - 1)(\delta\xi)^{\beta+1}$. Moreover, $\|u\| \rightarrow \infty$ as $\lambda \rightarrow (\alpha - \beta - 1)(\delta\xi)^{\beta+1}$.*

5. Rellich–Pohozaev identities

In this section we discuss both a nonexistence and a uniqueness result for radial solutions of semilinear elliptic equations defined on N -dimensional balls. These results are based on a well-known theorem due to Pohozaev [89] (see also [77,100]).

The Rellich–Pohozaev identity (cf. [8]) is an important identity (which since has been extended considerably) which has proved useful in establishing that certain nonlinear boundary value problems on starlike domains¹ do not have solutions. The identity is concerned with smooth solutions of problems, like

$$\begin{cases} \Delta u + f(x, u) = 0, & x \in \Omega, \\ u = 0, & x \in \partial\Omega, \end{cases} \tag{5.1}$$

where Ω is a starlike domain, which in our case will be assumed to be a ball. Since most of the results are easier to write for partial differential equations, we shall write our equations as partial differential equations, bearing in mind that in the cases of interest positive solutions will be radial solutions and hence solutions of associated ordinary differential equations.

We let

$$F(x, u) = \int_0^u f(x, s) \, ds$$

and obtain the following identity

$$\begin{aligned} \int_{\partial\Omega} x \cdot |\nabla u|^2 \nu \, dS &= 2N \int_{\Omega} F(x, u) \, dx + 2 \int_{\Omega} \nabla F(x, u) \cdot x \, dx \\ &\quad - (N - 2) \int_{\Omega} u f(x, u) \, dx. \end{aligned} \tag{5.2}$$

We have the following immediate consequence:

¹ Ω is star-shaped if there exists $x_0 \in \Omega$ such that $(x - x_0) \cdot \nu \geq 0$ for all $x \in \partial\Omega$.

THEOREM 5.1. Assume that f is independent of x , and Ω is a starlike domain and

$$2NF(u) - (N - 2)uf(u) \leq 0, \quad u \geq 0.$$

Then (5.1) has no positive solution.

A consequence of this theorem when $f(u) = |u|^{p-1}u$, $p \geq 1$, is the following result:

COROLLARY 5.2. Assume that

$$\frac{N + 2}{N - 2} \leq p,$$

then the problem

$$\begin{cases} (r^{N-1}u')' + r^{N-1}f(u) = 0, & 0 < r < R, \\ u'(0) = u(R) = 0, \end{cases} \tag{5.3}$$

has no positive solutions.

Refinements of the original Pohozaev argument for proving the above identity (see [77, 100]) also give uniqueness results for positive solutions of problems like the above containing a parameter. Namely we have the following:

THEOREM 5.3. Assume that $N \geq 3$, that

$$f(u) > 0, \quad f'(u) > 0, \quad u \geq 0$$

and there exists $\alpha > 0$, such that

$$\sup_{u \geq \alpha} \left\{ \frac{2N}{N - 2} \right\} \left\{ \frac{F(u)}{uf(u)} \right\} < 1. \tag{5.4}$$

Then

$$\begin{cases} (r^{N-1}u')' + \lambda r^{N-1}f(u) = 0, & 0 < r < R, \\ u'(0) = u(R) = 0, \end{cases} \tag{5.5}$$

has a unique positive solution for $\lambda \geq 0$ small.

In particular, we can apply the above result for the case that $f(u) = e^u$ and obtain that for small values of λ the solution found earlier is the unique positive solution. Note that the earlier results also tell us that the condition that $N \geq 3$ is needed.

5.1. More general equations

Nonexistence results also exist for the class of equations defined in the introduction, i.e.,

$$\begin{cases} r^{-\gamma} (r^\alpha |u'|^\beta u')' = f(r, u), & r \in (0, R), \\ u > 0, & r \in (0, R), \\ u'(0) = u(R) = 0, \end{cases} \tag{5.6}$$

In 1985 Pucci and Serrin [91] extended Pohozaev’s identity (5.2) to a larger class of variational equations. Let $L = L(p, z, x)$ denote a Lagrangian which is C^2 on the domain $\mathbb{R}^N \times \mathbb{R} \times \overline{\Omega}$. Smooth critical points of the associated “energy” functional satisfy the Euler–Lagrange equation

$$-\sum_{i=1}^N (L_{p_i}(Du, u, x))_{x_i} + L_z(Du, u, x) = 0, \quad \text{in } \Omega. \tag{5.7}$$

We assume without loss of generality that $L(0, 0, x) = 0$ in Ω . The main identity of Pucci–Serrin is due to the following proposition:

PROPOSITION 5.4. *Let $u \in C^2(\Omega)$ be a solution of the Euler–Lagrange equation (5.7), and let a and \vec{h} be, respectively, scalar and vector valued functions of class $C^1(\Omega)$. Then the following relation holds in Ω :*

$$\begin{aligned} & \frac{\partial}{\partial x_i} \left[\vec{h}_i L(Du, u, x) - \vec{h}_j \frac{\partial u}{\partial x_j} L_{p_i}(Du, u, x) - au L_{p_i}(Du, u, x) \right] \\ &= \frac{\partial \vec{h}_i}{\partial x_i} L(Du, u, x) + \vec{h}_i L_{x_i}(Du, u, x) - \left(\frac{\partial u}{\partial x_j} \frac{\partial \vec{h}_j}{\partial x_i} + u \frac{\partial a}{\partial x_i} \right) L_{p_i}(Du, u, x) \\ & \quad - a \left(\frac{\partial u}{\partial x_i} L_{p_i}(Du, u, x) + u L_z(Du, u, x) \right), \end{aligned} \tag{5.8}$$

where repeated indices i and j are to be summed from 1 to N .

The proof is obtained by direct computation, using (5.7).

If $u \in C^2(\Omega) \cap C^1(\overline{\Omega})$ solves (5.7) with $u = 0$ on $\partial\Omega$ then $u_{x_i} = (\partial u / \partial \nu) v_i$ on $\partial\Omega$ so

$$\vec{h}_j \frac{\partial u}{\partial x_j} L_{p_i}(Du, u, x) v_i = \frac{\partial u}{\partial x_i} L_{p_i}(Du, u, x) \vec{h}_j v_j \quad \text{on } \partial\Omega. \tag{5.9}$$

Integrating (5.8) over Ω , applying (5.9), $u = 0$ on $\partial\Omega$, and the divergence theorem one obtains the fundamental identity

$$\int_{\partial\Omega} \left[L(Du, 0, x) - \frac{\partial u}{\partial x_i} L_{p_i}(Du, 0, x) \right] (\vec{h} \cdot \nu) \, ds$$

$$\begin{aligned}
 &= \int_{\Omega} L(Du, u, x) \operatorname{div} \vec{h} + \vec{h}_i L_{x_i}(Du, u, x) \\
 &\quad - \left(\frac{\partial u}{\partial x_j} \frac{\partial \vec{h}_j}{\partial x_i} + u \frac{\partial a}{\partial x_i} \right) L_{p_i}(Du, u, x) \\
 &\quad - a \left(\frac{\partial u}{\partial x_i} L_{p_i}(Du, u, x) + u L_z(Du, u, x) \right) dx. \tag{5.10}
 \end{aligned}$$

For example, if $L(p, z) = \frac{1}{2}|p|^2 - F(z)$, $\vec{h} = x$, and a is constant, then (5.10) reduces to

$$- \int_{\partial\Omega} \frac{1}{2} |Du|^2 (x \cdot \nu) ds = \int_{\Omega} \left[\frac{N}{2} - 1 - a \right] |Du|^2 - NF(u) + a u f(u) dx. \tag{5.11}$$

The choice of $a(x) = (N - 2)/2$ makes the $|Du|^2$ term vanish and reduces (5.11) to the Pohozaev identity (5.2). However, identity (5.10) is applicable to a much larger class of equations. For instance, for the quasilinear equation

$$\begin{cases} \Delta_p u + f(u) = 0, & x \in \Omega, \\ u = 0, & x \in \partial\Omega, \end{cases} \tag{5.12}$$

with associated Lagrangian $L(Du, u) = \frac{1}{p}|Du|^p - F(u)$, the choice of $\vec{h} = x$ and constant a yields

$$- \int_{\partial\Omega} \frac{1}{p} |Du|^p (x \cdot \nu) ds = \int_{\Omega} \left[\frac{N}{p} - 1 - a \right] |Du|^p - NF(u) + a u f(u) dx. \tag{5.13}$$

Now we see the choice of $a = (N - p)/p$ implies

$$- \int_{\partial\Omega} \frac{1}{p} |Du|^p (x \cdot \nu) ds = \int_{\Omega} \left[\frac{N - p}{p} \right] u f(u) - NF(u) dx, \tag{5.14}$$

from which an appropriate nonexistence result can be stated. To determine the critical exponent we choose $f(u) = |u|^{q-1}u$ and find (5.12) has no nontrivial solutions when $p < n$ and

$$q > \frac{Np}{N - p} - 1 = \frac{(p - 1)N + p}{N - p}.$$

Note that $p^* = Np/(N - p)$ is the Sobolev exponent, corresponding to the loss of compactness for the continuous embedding $W^{1,p}(\Omega) \subset L^q(\Omega)$. Many further applications of (5.10) may be found in [91].

Solutions to the k -Hessian equation

$$\begin{cases} S_k(D^2u) = f(x, u), & x \in \Omega, \\ u = 0, & x \in \partial\Omega, \end{cases} \tag{5.15}$$

correspond to critical points of the functional

$$I_k[u] = -\frac{1}{k+1} \int_{\Omega} u S_k(D^2u) \, dx + \int_{\Omega} F(x, u) \, dx, \tag{5.16}$$

where $F(x, u) = \int_0^u f(x, s) \, ds$. However, Proposition 5.8 does not directly apply to (5.16) since the Lagrangian contains higher order terms, and one needs to derive an appropriate higher order analog of (5.8).

The Euler–Lagrange equation associated with the Lagrangian $L = L(D^2u, Du, u, x) = L(r_{ij}, p_i, z, x)$, where $r_{ij} = r_{ji}$ is

$$\begin{aligned} & \sum_{i,j=1}^N \frac{\partial^2}{\partial x_i \partial x_j} L_{r_{ij}}(D^2u, Du, u, x) - \sum_{i=1}^N (L_{p_i}(D^2u, Du, u, x))_{x_i} \\ & + L_z(D^2u, Du, u, x) = 0. \end{aligned} \tag{5.17}$$

In this case the fundamental identity (simplified for our purposes) takes the form (see Equation (29) in [91])

PROPOSITION 5.5. *Let $u \in C^4(\Omega)$ be a solution to the Euler–Lagrange equation (5.17) with $L_{p_i} = 0$ and $a \in C^2(\Omega)$ a scalar function. Then*

$$\begin{aligned} & \frac{\partial}{\partial x_i} \left[x_i L + \left(x_l \frac{\partial u}{\partial x_l} + au \right) \frac{\partial L_{r_{ij}}}{\partial x_j} - \frac{\partial}{\partial x_j} \left(x_l \frac{\partial u}{\partial x_l} + au \right) L_{r_{ij}} \right] \\ & = NL + x_i L_{x_i} - au L_z - (a+2) \frac{\partial^2 u}{\partial x_i \partial x_j} L_{r_{ij}}. \end{aligned} \tag{5.18}$$

This identity can be used to determine the critical exponent associated to the operator S_k [109]. For simplicity we assume $F = F(z)$ (e.g., $f(u) = |u|^p$).

THEOREM 5.6. *Let Ω be a smooth domain which is star-shaped with respect to the origin. Assume $f : (-\infty, 0] \rightarrow [0, \infty)$ is smooth, with $f(s) > 0$ for $s < 0$ and $f(0) = 0$. Then*

$$\begin{cases} S_k(D^2u) = f(u), & x \in \Omega, \\ u = 0, & x \in \partial\Omega, \end{cases} \tag{5.19}$$

has no nontrivial solutions in $C^4(\Omega) \cap C^1(\overline{\Omega})$ when

$$NF(u) - \frac{N-2k}{k+1} uf(u) > 0, \quad \text{for } u < 0. \tag{5.20}$$

PROOF. Applying Proposition 5.5 to the Lagrangian $L = \frac{-zS_k(r_{ij})}{k+1} + F(z)$ with $a = (N - 2k)/(k + 1)$ and integrating, one obtains

$$-\frac{1}{k+1} \int_{\partial\Omega} [x_l u_{x_l} u_{x_j} S^{ij}(D^2u)] v_i \, ds = \int_{\Omega} \left(NF(u) - \frac{N-2k}{k+1} uf(u) \right) dx, \tag{5.21}$$

which simplifies to

$$-\frac{1}{k+1} \int_{\partial\Omega} (x \cdot \nu) |Du|^2 S^{ij}(D^2u) v_i v_j \, ds = \int_{\Omega} \left(NF(u) - \frac{N-2k}{k+1} uf(u) \right) dx. \tag{5.22}$$

For $u < 0$ the operator S_k is elliptic [109], thus $S^{ij}(D^2u)v_i v_j > 0$. Hence the left-hand side of (5.22) is nonpositive and the result follows. \square

Note that when $k = 1$, (5.20) is equivalent to the Pohozaev criterion (5.2). If $f(u) = (-u)^p$ then (5.20) reduces to

$$\frac{N-2k}{k+1} > \frac{N}{p+1}. \tag{5.23}$$

If $k \geq N/2$, then (5.23) cannot hold and we obtain no a priori obstructions to solution from this method. On the other hand, when $k < N/2$, then (5.23) is true when $p \geq \frac{(N+2)k}{N-2k}$. Thus when $k < N/2$ the *critical exponent* $\gamma(k)$ for S_k is defined by

$$\gamma(k) = \frac{(N+2)k}{N-2k}. \tag{5.24}$$

Complementary existence results for radially symmetric solutions for subcritical exponents (and for all exponents when $k \geq N/2$) are proved in [109], thus one can extend $\gamma(k)$ to all k via

$$\gamma(k) = \begin{cases} \infty, & k > N/2, \\ \frac{(N+2)k}{N-2k}, & k < N/2. \end{cases} \tag{5.25}$$

In particular, there is no critical exponent for the Monge–Ampère operator. Heuristically, operators “closer” to the Laplace operator have critical exponents, while operators “closer” to Monge–Ampère do not. Note that when $p = k$ one has an eigenvalue problem (see, e.g., [70,110,57]).

5.2. Critical dimensions

In 1983 Brezis and Nirenberg [16] observed that lower order perturbations to elliptic equations involving critical exponents recover the lost compactness. More precisely, they proved the equation

$$\begin{cases} \Delta u + u^{\frac{N+2}{N-2}} + \lambda u = 0, & x \in \Omega, \\ u = 0, & x \in \partial\Omega, \end{cases} \tag{5.26}$$

has a positive solution if $0 < \lambda < \lambda_1$ and $N \geq 4$, where λ_1 is the principal eigenvalue for $-\Delta$ on $H_0^1(\Omega)$. Surprisingly, for the case $N = 3$ they observed that there exists $\lambda^* > 0$ such that (5.26) has a solution for $\lambda \in (\lambda^*, \lambda_1)$ and no solution for $\lambda \in (0, \lambda^*)$. If Ω is a ball, then $\lambda^* = \lambda_1/4$. In this context the dimension $N = 3$ is called a *critical dimension*.

Since both Δ_p and S_k have critical exponents (when $p < N$ and $k < N/2$, respectively), it is natural to ask if results similar to the Brezis–Nirenberg result exist for these operators. Several authors have answered this question affirmatively. Rather than treat Δ_p and S_k separately, Clément et al. [22] consider the equation

$$\begin{cases} (r^\alpha |u'|^\beta u')' = r^\gamma |u|^{q-2}u, & r \in (0, R), \\ u > 0, & r \in (0, R), \\ u'(0) = u(R) = 0, \end{cases} \tag{5.27}$$

and the perturbed form

$$\begin{cases} (r^\alpha |u'|^\beta u')' = r^\gamma |u|^{q-2}u + \lambda r^\delta |u|^\beta u, & r \in (0, R), \\ u > 0, & r \in (0, R), \\ u'(0) = u(R) = 0, \end{cases} \tag{5.28}$$

for various values of exponents α, β, δ and γ . See the table in Section 4.1 for the relevant values of constants for (5.15) or (5.12).

The critical exponent associated with (5.27) is

$$q^* = \frac{(\gamma + 1)(\beta + 2)}{\alpha - \beta - 1}. \tag{5.29}$$

For the p -Laplacian, $q^* = \frac{Np}{N-p}$ and for S_k , $q^* = \frac{N(k+1)}{N-2k}$.

Concerning the parameters involved, we assume the following inequalities hold:

$$q - 1 > \beta + 1 > 0, \quad \gamma + 1 > \alpha - \beta - 1, \tag{5.30}$$

$$\alpha - \beta - 1 > 0, \quad \delta + 1 \geq \alpha - \beta - 1, \tag{5.31}$$

$$\gamma, \delta > \alpha - 1, \tag{5.32}$$

$$\alpha - \beta - 2 < \delta. \tag{5.33}$$

When applied to S_k (respectively Δ_p) these inequalities imply $q > k + 1$ (respectively $q > p$) and $k < N/2$ (respectively $N < p$), i.e., one is in the realm of critical exponents.

The main theorems concerning (5.28) is as follows:

THEOREM 5.7. *Assume (5.30), (5.31), (5.32), (5.33) hold. If $\lambda \leq 0$ and $q = q^*$, then (5.28) has no solution.*

THEOREM 5.8. *Assume (5.30), (5.31), (5.32), (5.33), $\beta \geq 0$ and $q = q^*$. If*

$$(\beta + 1)(\delta + 1) - (\alpha - \beta - 1)(\beta + 2) > 0, \tag{5.34}$$

then there exists $\lambda^ > 0$ such that (5.28) has no solution for $\lambda \in (0, \lambda^*)$.*

In the case of the operators S_k and Δ_p , their parameters satisfying (5.34) correspond to certain values of the dimension N , called *critical dimensions* by Pucci and Serrin [92]. For the p -Laplace operator, (5.34) corresponds to $N < p^2$, thus the critical dimensions for Δ_p are those n with $p < N < p^2$. Note that for the Laplacian $p = 2$ and we obtain $2 < N < 4$, thus the only critical dimension is $N = 3$, as observed by Brezis and Nirenberg. For the k -Hessian the critical dimensions are those N with $2k < N < 2k(k + 1)$.

The proofs are based on the following identity of Pohozaev–Pucci–Serrin type [22]:

PROPOSITION 5.9. *Let $a, b \in C^1[0, \infty)$. If $u \in C^2(0, \infty) \cap C^1[0, \infty)$ solves*

$$-(r^\alpha |u'|^\beta u')' = f(r, u) \quad \text{in } (0, \infty), \tag{5.35}$$

then for $R > 0$ we have

$$\begin{aligned} & \left[-r^\alpha u' |u'|^\beta \left(au + \frac{\beta + 1}{\beta + 2} bu' \right) \right]_{r=R} + \int_0^R r^\alpha a' uu' |u'|^\beta dr \\ & + \int_0^R r^\alpha \left(a + \frac{\beta + 1}{\beta + 2} b' - \frac{\alpha}{\beta + 2} \frac{b}{r} \right) |u'|^{\beta+2} dr \end{aligned} \tag{5.36}$$

$$= [bF(r, u)]_{r=R} + \int_0^R a u f(r, u) - b F_r(r, u) - b' F(r, u) dr. \tag{5.37}$$

6. Problems linear at infinity

In Section 2 we discussed several bifurcation results for boundary value problems which had a trivial solution. The bifurcation was detected by writing the problems as an equivalent operator equation which was of the form

$$u - F(\lambda, u) = 0,$$

where

$$F : \mathbb{R} \times E \rightarrow E$$

is a completely continuous operator and E is the Banach space of continuous functions on $[0, R]$. For the problems to follow such an equivalence will also be the case, except that F will satisfy the following conditions: There exist $a < b$ such solutions of

$$u - F(a, u) = 0 = u - F(b, u)$$

are a priori bounded and

$$\deg_{\text{LS}}(id - F(a, \cdot), B(0, r), 0) \neq \deg_{\text{LS}}(id - F(b, \cdot), B(0, r), 0),$$

where the latter condition is to hold for all r , sufficiently large. Under these assumptions we obtain the following *bifurcation from infinity* result (see, e.g., [93,101]):

PROPOSITION 6.1. *There exists a continuum \mathcal{C} of solutions of $u - F(\lambda, u) = 0$ which bifurcates from infinity in (a, b) .*

The above means that the continuum \mathcal{C} has the property that there exists a sequence $\{(\lambda_n, u_n)\} \subset \mathcal{C}$, such that $\{\lambda_n\} \subset (a, b)$ and $\|u_n\| \rightarrow \infty$.

Here we rely mainly on the work [97,98,85–87]. Consider the boundary value problem

$$\begin{cases} \Delta u + \lambda f(u) + h(x) = 0, & x \in \Omega, \\ u = 0, & x \in \partial\Omega, \\ u > 0, & x \in \Omega, \end{cases} \quad (6.1)$$

where f satisfies

$$f(s) = s + g(s), \quad g(s) = o(|s|), \text{ as } |s| \rightarrow \infty. \quad (6.2)$$

Problem (6.1) is equivalent to an operator equation

$$u - \lambda F(u) - T(h) = 0 \quad (6.3)$$

in $\mathbb{R} \times E$ where E is the Banach space $C[0, R]$ with the usual norm, and both $F : E \rightarrow E$ and $T : E \rightarrow E$ are completely continuous.

Using the fact that λ_1 , the principal eigenvalue of $-\Delta$ on the Sobolev space $H_0^1(B_R)$, is simple and the above Proposition 6.1, we obtain the following corollary.

COROLLARY 6.2. *There exist continua \mathcal{C}^\pm of solutions of (6.1) bifurcating from infinity at λ_1 .*

It is these continua which we shall next describe for several cases of bounded nonlinear terms g .

6.1. Landesman–Lazer results

Regarding the function g , we now introduce the following quantities:

$$\gamma_1 = \limsup_{t \rightarrow \infty} g(t),$$

$$\gamma_2 = \liminf_{t \rightarrow -\infty} g(t),$$

$$\gamma_3 = \limsup_{t \rightarrow -\infty} g(t),$$

$$\gamma_4 = \liminf_{t \rightarrow \infty} g(t),$$

and we have the following results.

THEOREM 6.3. *Assume that*

$$\gamma_1 < 0 < \gamma_2.$$

Then there exists a neighborhood I of λ_1 , such that problem (6.1) has

- *at least one solution for $\lambda \in I, \lambda \geq \lambda_1$,*
- *at least three solutions for $\lambda \in I, \lambda < \lambda_1$.*

THEOREM 6.4. *Assume that*

$$\gamma_3 < 0 < \gamma_4.$$

Then there exists a neighborhood I of λ_1 , such that problem (6.1) has

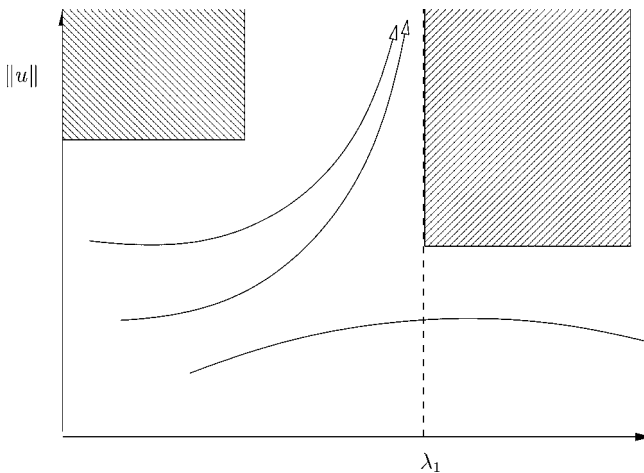

Fig. 7. Illustration of Theorem 6.3. A similar reflected picture holds for Theorem 6.4.

- at least one solution for $\lambda \in I, \lambda \leq \lambda_1$,
- at least three solutions for $\lambda \in I, \lambda > \lambda_1$.

These results are proved using the existence of the continua above and analyzing their location with respect to the hyperplane $\lambda = \lambda_1$. This may be accomplished by considering the asymptotic behavior of integrals of the form

$$\int_{B_R} g(t\phi + w)\phi \, dx,$$

with ϕ a principal eigenfunction of $-\Delta$ and w suitably chosen in the orthogonal complement of ϕ . We refer to [75,76,100].

6.2. Nonlinear terms which oscillate

We next discuss some multiplicity results from [97,98] regarding the continua which bifurcate from infinity for nonlinear terms g which are bounded and oscillatory. Letting ϕ denote a positive eigenfunction of $-\Delta$ corresponding to λ_1 , we assume that

$$\int_{\Omega} h\phi \, dx = 0.$$

Let $(\lambda, u) \in \mathcal{C}^+$ be a solution of (6.1), then we obtain

$$\lambda \int_{\Omega} g(u)\phi \, dx = \|u\|(\lambda_1 - \lambda) \int_{\Omega} \frac{u}{\|u\|}\phi \, dx.$$

Letting $\mu = \|u\|(\lambda_1 - \lambda)$, the following results on the asymptotics of the solution branches hold:

PROPOSITION 6.5. *Assume $\int_0^\infty g(s)s \, ds$ exists, then*

$$\text{sgn } \mu = \text{sgn} \int_0^\infty g(s)s \, ds, \quad \text{for } \mu \text{ large}$$

and

$$\mu \|u\|^2 \rightarrow \frac{d(B_R)}{\int_{B_R} \phi^2 \, dx} \int_0^\infty g(s)s \, ds,$$

where

$$d(B_R) = \int_{\partial B_R} \frac{1}{|\nabla\phi|} \, dS.$$

PROPOSITION 6.6. *Assume that*

$$G(\beta) = \int_0^\beta g(s)s \, ds$$

is bounded and

$$M = \lim_{\beta \rightarrow \infty} \frac{1}{\beta} \int_0^\beta G(s) \, ds$$

exists. Then

- *If $N = 2$ then*

$$\|u\|^2 \mu = (G(\|u\|) - M)c(B_R) + Md(B_R) + R(\|u\|),$$

with

$$c(B_R) = \frac{N\omega_N}{2\sqrt{\det A}}, \quad A = -\frac{1}{2}D^2\phi(0).$$

- *If $N > 2$, then*

$$\|u\|^2 \mu = Md(B_R) + R(\|u\|),$$

with $R(\alpha) \rightarrow 0$ as $\alpha \rightarrow \infty$.

Concerning the constants $c(B_R)$ and $d(B_R)$ one has the following relationship

$$d(B_R) \geq c(B_R) \frac{2\lambda_1^{(N-1)/2}}{N^{N/2}}. \tag{6.4}$$

This relationship will be important in the result below, where interesting phenomena arise which are different for different dimension. Concerning the nonlinear term g , we shall assume that

$$g(t + T) = g(t), \quad \int_0^T g \, dt = 0$$

and

$$g = g'_1 = g''_2 = \dots, \quad \int_0^T g_i \, dt = 0.$$

We have the following theorem:

THEOREM 6.7. *Let $\{(u, \lambda)\}$ be the solution continuum of (6.1) described above. The following hold:*

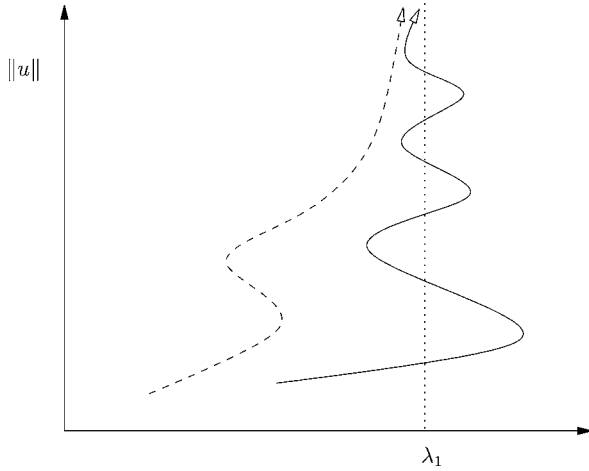

Fig. 8. Possible continua of Theorem 6.7. The dashed line is possible when $N > 4$.

- For $1 \leq N \leq 3$ there exist infinitely many solutions for $\lambda = \lambda_1$.
- For $N = 4$

$$\|u\|^2(\lambda - \lambda_1) = (g_2(\|u\|)c(B_R) + g_2(0)d(B_R)) + o(\|u\|^{-2})\|u\|^2,$$

as $\|u\| \rightarrow \infty$. Hence infinitely many positive solutions exist, whenever

$$\min_{s \in [0, T]} g_2(s) < -\frac{d(B_R)}{c(B_R)}g_2(0) < \max_{s \in [0, T]} g_2(s).$$

- For $N > 4$

$$\|u\|^2(\lambda - \lambda_1) = g_2(0)d(\Omega) + o(\|u\|^{-2})\|u\|^2$$

as $\|u\| \rightarrow \infty$.

We thus conclude that C^+ may lie on one side of the hyperplane $\lambda = \lambda_1$, if $N > 4$ and the nonlinear term g satisfies appropriate conditions. The above results are all valid in case the ball B_R is replaced by a convex set Ω with smooth boundary having the property that the eigenfunction ϕ (corresponding to λ_1) has a single critical point (for details see [98, 100]).

7. Symmetry breaking

Our motivation for discussing ordinary differential equations of the form considered earlier has been that they may be considered as equations whose solutions are radial solutions of certain problems for partial differential equations which admit radial solutions because of certain intrinsic symmetries in the equation and the underlying domain. Now, it may be the

case that all solutions of the problem at hand must be radial solutions (e.g., if the conditions of the Gidas–Ni–Nirenberg results [50] hold), or it may be case that nonradial solutions bifurcate from radial solutions as parameters are varied (see, e.g., [60,82,105]). It may also happen that nonradial solutions exist because minima of certain energy functionals over a function space of radial functions (which define radial solutions of equations at hand) strictly exceed minima of the same functional considered over a larger space (of not necessarily radial functions) and hence define other solutions of the problem at hand. It is this situation which we shall briefly discuss here.

Variational methods, of course, play an important role in the study of problems of the type that have been considered here and such methods have been used to prove the existence of nonradial solutions of Gelfand type problems on annular domains ([44]). Note that by the results in [50] nonradial solutions cannot exist for such problems if the domain is a ball, and hence the existence of nonradial solutions is due to the geometry of the domain.

Let us consider the boundary value problem

$$\begin{cases} u'' + \frac{N-1}{r}u' + \lambda f(u) = 0, & r \in (a, b), \\ u(a) = u(b) = 0 \end{cases} \tag{7.1}$$

solutions of which are radial solutions of

$$\begin{cases} \Delta u + \lambda f(u) = 0, & x \in \Omega, \\ u = 0, & x \in \partial\Omega, \end{cases} \tag{7.2}$$

where

$$\Omega = \{x \in \mathbb{R}^N : 0 < a < |x| = r < b\}.$$

By changing scale, we may assume that $b = 1$, and changing scale further, we also may assume that $\lambda = 1$ and a is a parameter and we consider

$$\begin{cases} \Delta u + f(u) = 0, & x \in \Omega, \\ u = 0, & x \in \partial\Omega. \end{cases} \tag{7.3}$$

For various classes of nonlinearities f , we established in Section 3 that these problems have positive solutions.

In case $f(u) = u^p$, $p < \frac{N+2}{N-2}$, $N \geq 3$, it was proved in [16] that (7.3) has nonradial positive solutions for any a , and if $f(u) = -u + u^p$, $p > 1$, $N = 2$, a similar result was established in [24], where it was also shown that the number of positive nonradial solutions increases without bound as $a \rightarrow 1$. These results have been extended by Lin [67,68] who established several bifurcation results (which will be summarized below) motivated by the results cited above. There is also the seminal work of Nagasaki and Suzuki [80,82] concerning nonradial solutions of the Gelfand equation on annuli in \mathbb{R}^2 , and higher dimensions, which we shall also summarize.

Let us characterize the various nonlinear terms considered and then state the pertinent results. It will always be assumed that f is a smooth function and $f(u) > 0$ for $u > 0$. Furthermore f may belong to one of the following classes of functions:

$$\frac{N}{N-2} f(u) \geq f'(u)u \geq (1 + \delta) f(u), \quad u > 0, \quad N \geq 3, \quad (7.4)$$

where δ is a positive constant;

$$f(u) = u^p, \quad 1 < p < \frac{N+2}{N-2}, \quad N \geq 2; \quad (7.5)$$

$$f(u) \leq \begin{cases} cu^p, & 1 < p < \frac{N+2}{N-2}, \quad N \geq 2 \\ e^{A(u)}, & A(u) = o(u^2), \quad u \rightarrow \infty, \quad N = 2. \end{cases} \quad (7.6)$$

For such nonlinearities the following theorem holds:

THEOREM 7.1. *If $f(u) = o(u)$, $u \rightarrow 0$, then under any of the above conditions positive nonradial solutions of (7.3) exist.*

Consider the Gelfand problem

$$\begin{cases} \Delta u + \lambda e^u = 0, & x \in \Omega, \\ u = 0, & x \in \partial\Omega, \end{cases} \quad (7.7)$$

with

$$\Omega = \{x \in \mathbb{R}^2: 0 < a < |x| = r < 1\}.$$

Using polar coordinates $x = (r \cos \theta, r \sin \theta)$ and the rotation

$$T_m x = \left(r \cos \left(\theta + \frac{\pi}{m} \right), r \sin \left(\theta + \frac{\pi}{m} \right) \right),$$

we consider, besides the space $V = H_0^1(\Omega)$, the spaces

$$V_m = \{v \in V: v(T_m x) = v(x)\}$$

and we call m the mode of a function v if m is the largest integer such that $v \in V_m$. For the functional

$$M: V \rightarrow \mathbb{R}$$

defined by

$$M(v) = \int_{\Omega} e^v dx,$$

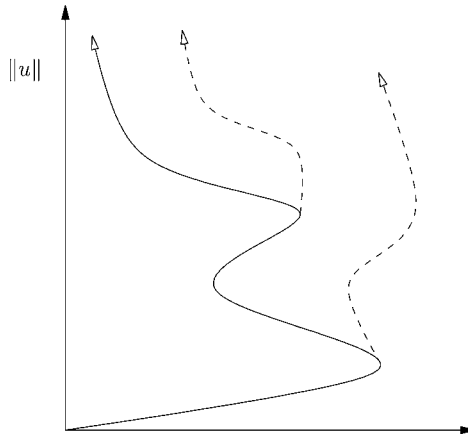

Fig. 9. Possible solution continua for Equation (7.2). The dashed lines represent symmetry breaking bifurcation branches.

the following result was established in [80]:

THEOREM 7.2. *For any positive integer m , there exists a number $\mu_m > 0$ such that for any $\mu > \mu_m$ problem (7.7) has a nonradial solution (λ, u) with u of mode m and $M(u) = \mu$.*

This suggests that the solution continua of positive radial solutions of (7.7) whose existence was established in Section 3 undergo secondary bifurcations. However, the proof of the above result uses variational methods and the continua were established using continuation methods based on degree theory. Thus the above suggestion about secondary bifurcations is a suggestion only. On the other hand, in their paper [82] Nagasaki and Suzuki have used a somewhat different method, based on Morse theory and topological degree theory to study symmetry breaking off radial solutions of (7.7) in case $N \geq 2$ and they conclude that the solution continuum of radial solutions \mathcal{C} of the Gelfand problem (7.7) undergoes infinitely many symmetry breaking bifurcations (into nonradial solutions) as $\lambda \rightarrow 0^+$ and $\|u\| \rightarrow \infty$. A similar approach has been used in [106] for semilinear equations involving power nonlinearities.

8. Whole space problems

In this final section we shall consider problems of the type

$$-\Delta u + u - |u|^{p-1}u = 0, \quad x \in \mathbb{R}^N, \quad p > 1, \tag{8.1}$$

and more general equations of the form

$$-\Delta u + V(x)u - (\Delta|u|^2)u = \lambda|u|^{p-1}u, \quad x \in \mathbb{R}^N, \tag{8.2}$$

where λ is a parameter. Again, we will be interested in radial solutions, i.e., solutions u which only depend upon $r = |x|$. Such solutions, of course, will, as before be solutions of corresponding ordinary differential equations. As in the case when the domain is a ball, positive solutions of (8.1) may be radial solutions by results similar to the results in [50]. In fact very similar results have been obtained, see, e.g., [27,28,102].

We shall call positive solutions of either of the equations ground states and we shall discuss results which guarantee the existence of ground states. The approach used in both cases is variational and we shall rely on results in [83,111] for Equation (8.1) and recent results from [90] for Equation (8.2). The latter equation is a fully nonlinear equation and has many interesting applications in mathematical physics. Some references to such applications may be found in [90].

The important Sobolev space for both problems is the space $W^{1,2}(\mathbb{R}^N)$ with the subspace

$$H_r^1(\mathbb{R}^N) = \{u \in W^{1,2}(\mathbb{R}^N): u \text{ is radial}\}.$$

A result of Strauss (see [111]) guarantees that the embedding

$$H_r^1(\mathbb{R}^N) \hookrightarrow L^q(\mathbb{R}^N), \quad 2 < q < \frac{2N}{N-2}, \tag{8.3}$$

is a compact embedding; this fact plays an important role in studying the functionals

$$I(u) = \frac{1}{2} \left(\int_{\mathbb{R}^N} |\nabla u|^2 \, dx + \int_{\mathbb{R}^N} |u|^2 \, dx \right), \tag{8.4}$$

$$J(u) = \frac{1}{2} \left(\int_{\mathbb{R}^N} |\nabla u|^2 \, dx + \int_{\mathbb{R}^N} V(x)|u|^2 \, dx \right) + \int_{\mathbb{R}^N} |\nabla u|^2 u^2 \, dx, \tag{8.5}$$

and

$$K(u) = \frac{1}{p+1} \int_{\mathbb{R}^N} |u|^{p+1} \, dx, \tag{8.6}$$

on the space $H_r^1(\mathbb{R}^N)$.

The compact embedding result plays an important role in establishing the so-called Palais–Smale condition, a condition which is used in verifying the mountain pass theorem. An alternate approach to such problems is the use of Lagrange multiplier techniques in which case the fact that the level sets

$$\{u \in H_r^1(\mathbb{R}^N): K(u) = \text{constant}\}$$

are weakly closed (which follows from the compact embedding result) plays a role. These approaches establish the existence of critical points of the defining functionals (or critical points subject to a constraint) which provide weak solutions of the differential equation. Some classical arguments then show that the weak solutions are actually smooth. Using

the well-known mountain pass theorem of Ambrosetti and Rabinowitz the following result has been established (see, e.g., [111]).

THEOREM 8.1. *Assume $1 < p < \frac{N+2}{N-2}$, then Equation (8.1) has a positive radial solution $u \in H_r^1(\mathbb{R}^N)$. This solution belongs to class $C^2(\mathbb{R}^N)$ and is a solution of the boundary value problem*

$$\begin{cases} u'' + \frac{N-1}{r}u' - u + |u|^{p-1}u = 0, & r \in (0, \infty), \\ u'(0) = u(\infty) = 0. \end{cases} \tag{8.7}$$

As already mentioned, this problem (for the case $N = 3$) was already studied by Nehari [83] using a variational approach. For Nehari’s case the problem becomes

$$\begin{cases} u'' + \frac{2}{r}u' - u + |u|^{p-1}u = 0, & r \in (0, \infty), \\ u'(0) = u(\infty) = 0, \end{cases} \tag{8.8}$$

with $1 < p < 5$. Letting $v = ru$, one finds that v is a solution of the equation

$$v'' - v + r^{1-p}v^p = 0. \tag{8.9}$$

The following example of Nehari [83] shows that for $p = 5$ no such solutions can exist (thus a result similar to the nonexistence result of Pohozaev [89] holds for problems defined in all of space, as well). For, if one assumes that such a solution exists, then v solves

$$v'' - v + r^{-4}v^5 = 0, \tag{8.10}$$

and using the identity

$$\frac{d}{dr} \left(r(v')^2 - vv' + \frac{v^6}{2r^3} \right) = (2rv' - v) \left(v'' + \frac{v^5}{r^4} \right),$$

one obtains, for any $0 < a < r < b$,

$$\left[r(v')^2 - vv' + \frac{v^6}{2r^3} \right]_a^b = \int_a^b (2rvv' - v^2) dr = [rv^2]_a^b - 2 \int_a^b v^2 dr. \tag{8.11}$$

One may show that

$$v(r) = O(e^{-r}), \quad r \rightarrow \infty, \quad v(r) = O(r), \quad r \rightarrow 0,$$

and hence conclude from (8.11) that

$$\int_0^\infty v^2 dr = 0,$$

contradicting that u is a nontrivial solution of (8.8) for $p = 5$.

The above example is but one of the many results available for the existence of positive radial ground states for equations of the form

$$\operatorname{div}(A(|\nabla u|)\nabla u) + f(u) = 0, \quad x \in \mathbb{R}^N.$$

For additional results we refer to the papers [84,88,102] and their references.

We now turn to the problem (8.2), then under various assumptions on the potential V one may establish results similar to the above using a variational approach (critical point theory). The assumptions imposed on $V \in L^1_{\text{loc}}(\mathbb{R}^N)$ and the number p belong to the following class:

(A) There exists a constant $\delta > 0$ such that

$$V(x) \geq \delta, \quad \text{a.e.}$$

(B) $V \in L^\infty(\mathbb{R}^N)$, and V is periodic in each coordinate; $p \geq 3$.

(C) $V \in L^\infty(\mathbb{R}^N)$, $V(x) \rightarrow \|V\|_{L^\infty}$, $|x| \rightarrow \infty$; $p \geq 3$.

(D) $V(x) \rightarrow \infty$, $|x| \rightarrow \infty$; $p > 1$.

The following results have been established (see [90]).

THEOREM 8.2. *Assume that $N = 1$ and that condition (A) and condition (B), (C), or (D) hold. Then for any $\alpha > 0$ there exists $\lambda_\alpha > 0$ such that*

$$-u'' + V(x)u - (u^2)'' u = \lambda_\alpha |u|^{p-1} u,$$

has a positive solution $u \in W^{1,2}(\mathbb{R})$. The function $\alpha \mapsto \lambda_\alpha$ is unbounded and lower semi-continuous. If it is the case that $p \geq 3$, then

$$\lim_{\alpha \rightarrow \infty} \lambda_\alpha = 0, \quad \lim_{\alpha \rightarrow 0^+} \lambda_\alpha = \infty.$$

In this case, furthermore, for each $\lambda > 0$, there exists an infinite sequence of positive solutions $\{u_n\} \subset W^{1,2}(\mathbb{R})$ of

$$-u'' + V(x)u - (u^2)'' u = \lambda |u|^{p-1} u,$$

with

$$J(u_n) \rightarrow \infty,$$

where J is given by (8.5).

For higher dimensions the following existence results are valid.

THEOREM 8.3. *Let $N \geq 2$ and $1 < p < \frac{N+2}{N-2}$. Then there exists a sequence $\{\lambda_n\}$, $\lambda_n \rightarrow \infty$, such that (8.2) admits for any $\lambda = \lambda_n$ a nontrivial nonnegative radial solution $u \in H_r^1(\mathbb{R}^N)$.*

In case $3 \leq p < \frac{N+2}{N-2}$, i.e., $N = 2$ or $N = 3$, there exists a corresponding sequence $\{\lambda_n\}$, satisfying $\lambda_n \rightarrow 0$, as well.

If $N = 3$ and $3 \leq p < 5$ and $\lambda > 0$, then (8.2) has a nontrivial nonnegative solution $u \in H_r^1(\mathbb{R}^3)$.

References

- [1] J.C. Alexander, *A primer on connectivity*, Fixed Point Theory (Sherbrooke, Que., 1980), Springer, Berlin (1981), 455–483.
- [2] W. Allegretto, P. Nistri and P. Zecca, *Positive solutions of elliptic nonpositone problems*, Differential Integral Equations **5** (1992), 95–101.
- [3] H. Amann, *On the number of solutions of asymptotically linear two point boundary value problems*, Arch. Rat. Mech. Anal. **55** (1974), 207–213.
- [4] A. Anane, *Simplicité et isolation de la première valeur propre du p -Laplacien*, C. R. Acad. Sci Paris **305** (1987), 725–728.
- [5] T. Aubin, *Some Nonlinear Problems in Riemannian Geometry*, Springer-Verlag, Berlin (1998).
- [6] J.G. Azorero, I.P. Alonso and J.-P. Puel, *Quasilinear problems with exponential growth in the reaction term*, Nonlinear Anal. TMA **22** (1994), 481–498.
- [7] M. Badiale and E. Nabana, *A note on radiality of solutions of p -Laplacian equation*, Appl. Anal. **52** (1994), 1–4, 35–43.
- [8] C. Bandle, *Isoperimetric Inequalities and Applications*, Pitman, London (1980).
- [9] C. Bandle, C.V. Coffman and M. Marcus, *Nonlinear elliptic problems in annular domains*, J. Differential Equations **69** (1987), 322–345.
- [10] C. Bandle and L.A. Peletier, *Problèmes de Dirichlet nonlinéaires dans des anneaux*, C. R. Acad. Sci. Paris **305** (1986), 181–184.
- [11] J. Bebernes and D. Eberly, *Mathematical Problems from Combustion Theory*, Applied Math. Sci., Vol. 83, Springer-Verlag, New York (1989).
- [12] A. ben Naoum and C. De Coster, *On the existence and multiplicity of positive solutions of the p -Laplacian separated boundary value problems*, Differential Integral Equations **10** (1997), 1093–1112.
- [13] M.S. Berger, *Nonlinearity and Functional Analysis*, Academic Press, New York (1977).
- [14] T. Bhattacharya, *Radial symmetry of the first eigenfunction for the p -Laplacian in the ball*, Proc. Amer. Math. Soc. **104** (1988), 169–174.
- [15] G. Bratu, *Sur les équations intégrales non linéaires*, Bull. Soc. Math. France **42** (1914), 113–142.
- [16] H. Brezis and L. Nirenberg, *Positive solutions of nonlinear elliptic equations involving critical Sobolev exponents*, Comm. Pure Appl. Math. **36** (1983), 437–477.
- [17] A. Castro and A. Kurepa, *Energy analysis of a nonlinear singular differential equation and applications*, Rev. Colombiana Mat. **21** (1987), 155–166.
- [18] A. Castro and A. Kurepa, *Infinitely many radially symmetric solutions to a superlinear Dirichlet problem in a ball*, Proc. Amer. Math. Soc. **101** (1987), 57–64.
- [19] A. Castro and R. Shivaji, *Nonnegative solutions for a class of radially symmetric nonpositone problems*, Proc. Amer. Math. Soc. **106** (1989), 735–740.
- [20] S. Chandrasekhar, *An Introduction to the Study of Stellar Structure*, Dover, New York (1957).
- [21] S.N. Chow and J.K. Hale, *Methods of Bifurcation Theory*, Springer-Verlag, New York (1982).
- [22] P. Clément, D. de Figueiredo and E. Mitidieri, *Quasilinear elliptic equations with critical exponents*, Topol. Methods Nonlinear Anal. **7** (1996), 133–170.
- [23] P. Clément, M. García-Huidobro, R. Manásevich and K. Schmitt, *Mountain pass type solutions for quasilinear elliptic equations*, Calc. Variations PDE **11** (2000), 33–62.
- [24] C.V. Coffman, *A nonlinear boundary value problem with many positive solutions*, J. Differential Equations **54** (1984), 429–437.
- [25] C.V. Coffman and M. Marcus, *Existence and uniqueness results for semilinear Dirichlet problems in annuli*, ARCH (1991), 293–307.

- [26] M.G. Crandall and P.H. Rabinowitz, *Some continuation and variation methods for positive solutions of nonlinear elliptic eigenvalue problems*, Arch. Rat. Mech. Anal. **58** (1975), 207–218.
- [27] L. Damascelli and F. Pacella, *Monotonicity and symmetry of solutions of p -Laplace equations. $1 < p < 2$, via the moving plane method*, Atti Accad. Naz. Lincei Cl. Sci. Fis. Mat. Natur. Rend. Lincei (9) Mat. Appl. **9** (1998), 95–100.
- [28] L. Damascelli and F. Pacella, *Monotonicity and symmetry results for p -Laplace equations and applications*, Adv. Differential Equations **5** (2000), 1179–1200.
- [29] H. Dang, R. Manásevich and K. Schmitt, *Positive radial solutions of some nonlinear partial differential equations*, Math. Nachr. **186** (1997), 101–113.
- [30] H. Dang and K. Schmitt, *Existence of positive solutions for semilinear elliptic equations in annular domains*, Differential Integral Equations **7** (1994), 747–758.
- [31] H. Dang, K. Schmitt and R. Shivaji, *On the number of solutions of boundary value problems involving the p -Laplacian*, Electr. J. Differential Equations **1996** (1996), 137–148.
- [32] K. Deimling, *Nonlinear Functional Analysis*, Springer-Verlag, New York (1987).
- [33] M.A. Del Pino, M. Elgueta and R.F. Manásevich, *A homotopic deformation along p of a Leray–Schauder degree result and existence for $(|u'|^{p-2}u')' + f(t, u) = 0$, $u(0) = u(T) = 0$, $p > 1$* , J. Differential Equations **80** (1989), 1–13.
- [34] M.A. Del Pino and R.F. Manásevich, *Global bifurcation from the eigenvalues of the p -Laplacian*, J. Differential Equations **92** (1991), 226–251.
- [35] P. Delanoë, *Radially symmetric boundary value problems for real and complex elliptic Monge–Ampère equations*, J. Differential Equations **58** (1985), 318–344.
- [36] P. Drábek and R. Manásevich, *On the closed solution to some nonhomogeneous eigenvalue problems with p -Laplacian*, Differential and Integral Equations (1999).
- [37] A. el Hachimi and F. de Thélin, *Infinitely many radially symmetric solutions for a quasilinear problem in a ball*, J. Differential Equations **128** (1996), 78–102.
- [38] V. Emden, *Gaskugeln*, Leipzig (1907).
- [39] L. Erbe and K. Schmitt, *On radial solutions of semilinear elliptic problems*, Differential Integral Equations **1** (1988), 71–78.
- [40] D.A. Frank-Kamenetskii, *Diffusion and Heat Exchange in Chemical Kinetics*, Princeton University Press, Princeton (1955).
- [41] L. Friedlander, *Asymptotic behavior of the eigenvalues of the p -Laplacian*, Comm. Partial Differential Equations **14** (1989), 1059–1069.
- [42] T. Gallouët, F. Mignot and J.-P. Puel, *Quelques résultats sur le problème $-\Delta u = \lambda e^u$* , C. R. Acad. Sci. Paris Sér. I Math. **307** (1988), 289–292.
- [43] J. García Azorero and I. Peral Alonso, *Multiplicity of solutions for elliptic problems with critical exponent or with a nonsymmetric term*, Trans. Amer. Math. Soc. **323** (1991), 877–895.
- [44] J. García Azorero and I. Peral Alonso, *On an Emden–Fowler type equation*, Nonlinear Anal. **18** (1992), 1085–1097.
- [45] M. García-Huidobro, R. Manásevich and K. Schmitt, *On the principal eigenvalue of p -Laplacian like operators*, J. Differential Equations **130** (1996), 235–246.
- [46] M. García-Huidobro, R. Manásevich and K. Schmitt, *Some bifurcation results for a class of p -Laplacian like operators*, Differential Integral Equations **10** (1997), 51–66.
- [47] M. García-Huidobro, R. Manásevich and K. Schmitt, *Positive radial solutions of quasilinear elliptic partial differential equations on a ball*, Nonlinear Anal. TMA **35** (1999), 175–190.
- [48] M. García-Huidobro, R. Manásevich and F. Zanolin, *Strongly nonlinear second order ODEs with rapidly growing terms*, J. Math. Anal. Appl. **202** (1996), 1–26.
- [49] I.M. Gelfand, *Some problems in the theory of quasilinear equations*, Amer. Math. Soc. Transl. Ser. 2 **29** (1963), 295–381.
- [50] B. Gidas, W. Ni and L. Nirenberg, *Symmetry and related properties via the maximum principle*, Comm. Math. Phys. **68** (1979), 209–243.
- [51] G.B. Gustafson and K. Schmitt, *Nonzero solutions of boundary value problems for second order ordinary and delay differential equations*, J. Differential Equations **12** (1972), 125–147.
- [52] K. Gustafson, *Combustion and explosion equations and their calculation*, Computational Techniques in Heat Transfer (Seattle, Wash., 1983), Vol. 1, Pineridge, Swansea (1985), 161–195.

- [53] D. Hai and K. Schmitt, *On radial solutions of quasilinear boundary value problems*, Topics in Nonlinear Analysis, Birkhäuser, Basel (1999), 349–361.
- [54] D. Hai, K. Schmitt and R. Shivaji, *Positive solutions of quasilinear boundary value problems*, J. Math. Anal. Appl. **217** (1998), 672–686.
- [55] P. Hartman, *Ordinary Differential Equations*, second ed., Birkhäuser, Boston (1982).
- [56] J. Heinonen, T. Kilpeläinen and O. Martio, *Nonlinear Potential Theory of Degenerate Elliptic Equations*, Clarendon Press, Oxford University Press, New York (1993).
- [57] J. Jacobsen, *Global bifurcation problems associated with k -Hessian operators*, Topol. Methods Nonlinear Anal. **14** (1999), 81–130.
- [58] J. Jacobsen, *A Liouville–Gelfand equation for k -Hessian operators*, Rocky Mountain J. Math. **34** (2004), 665–684.
- [59] J. Jacobsen and K. Schmitt, *The Liouville–Bratu–Gelfand problem for radial operators*, J. Differential Equations **184** (2002), 283–298.
- [60] W. Jäger and K. Schmitt, *Symmetry breaking in semilinear elliptic problems*, Analysis ETC, Moser Anniversary Volume, P. Rabinowitz and E. Zehnder, eds., Academic Press, New York (1990), 451–470.
- [61] D.D. Joseph and T.S. Lundgren, *Quasilinear Dirichlet problems driven by positive sources*, Arch. Rat. Mech. Anal. **49** (1973), 241–269.
- [62] H. Kaper, M. Knaap and M. Kwong, *Existence theorems for second order boundary value problems*, Differential Integral Equations **4** (1991), 543–554.
- [63] J.L. Kazdan and F.W. Warner, *Remarks on some quasilinear elliptic equations*, Comm. Pure Appl. Math. **28** (1975), 567–597.
- [64] M. Krasnosel’skii, *Topological Methods in the Theory of Nonlinear Integral Equations*, Pergamon, Oxford (1963).
- [65] M. Krasnosel’skii, *Positive Solutions of Operator Equations*, Noordhoff, Groningen (1964).
- [66] V. Le and K. Schmitt, *On boundary value problems for degenerate quasilinear elliptic equations and inequalities*, J. Differential Equations **144** (1998), 170–218.
- [67] S.S. Lin, *Positive radial solutions and non-radial bifurcation for semilinear elliptic equations in annular domains*, J. Differential Equations **86** (1990), 367–391.
- [68] S.S. Lin, *Existence of positive nonradial solutions for nonlinear elliptic equations in annular domains*, Trans. Amer. Math. Soc. **332** (1992), 775–791.
- [69] P. Lindqvist, *On the equation $\operatorname{div}(|\nabla u|^{p-2}\nabla u) + \lambda|u|^{p-2}u = 0$* , Proc. Amer. Math. Soc. **109** (1990), 157–164.
- [70] P.L. Lions, *Two remarks on Monge–Ampère equations*, Ann. Mat. Pura Appl. **142** (1985), 263–275.
- [71] J. Liouville, *Sur l’équation aux différences partielles $\frac{d^2 \log \lambda}{du dv} \pm \frac{\lambda}{2a^2} = 0$* , J. Math. Pures Appl. **18** (1853), 71–72.
- [72] N.G. Lloyd, *Degree Theory*, Cambridge Tracts in Mathematics, Vol. 73, Cambridge University Press, Cambridge (1978).
- [73] R. Manásevich, F.I. Njoku and F. Zanolin, *Positive solutions for the one-dimensional p -Laplacian*, Differential Integral Equations **8** (1995), 213–222.
- [74] R. Manásevich and K. Schmitt, *Boundary value problems for quasilinear second order differential equations*, Non-Linear Analysis and Boundary Value Problems for Ordinary Differential Equations (Udine), F. Zanolin, ed., Springer, Vienna (1996), 79–119.
- [75] J. Mawhin and K. Schmitt, *Landesman–Lazer type problems at an eigenvalue of odd multiplicity*, Results Math. **14** (1988), 138–146.
- [76] J. Mawhin and K. Schmitt, *Nonlinear eigenvalue problems with the parameter near resonance*, Ann. Polon. Math. **51** (1990), 241–248.
- [77] J. S. McGough, *On solution continua of supercritical quasilinear elliptic problems*, Differential Integral Equations **7** (1993), 1453–1471.
- [78] F. Mignot and J.-P. Puel, *Solution radiale singulière de $-\Delta u = \lambda e^u$* , C. R. Acad. Sci. Paris Sér. I Math. **307** (1988), 379–382.
- [79] F. Mignot and J.-P. Puel, *Quelques résultats sur un problème elliptique avec non linéarité exponentielle*, Équations aux dérivées partielles et applications, Gauthier-Villars, Éd. Sci. Méd. Elsevier, Paris (1998), 683–704.

- [80] K. Nagasaki and T. Suzuki, *Radial and nonradial solutions for the nonlinear eigenvalue problem $\Delta u + \lambda e^u = 0$ on annuli in R^2* , J. Differential Equations **87** (1990), 144–168.
- [81] K. Nagasaki and T. Suzuki, *Radial solutions for $\Delta u + \lambda e^u = 0$ on annuli in higher dimensions*, J. Differential Equations **100** (1992), 137–161.
- [82] K. Nagasaki and T. Suzuki, *Spectral and related properties about the Emden–Fowler equation $-\Delta u = \lambda e^u$ on circular domains*, Math. Ann. **299** (1994), 1–15.
- [83] Z. Nehari, *On a nonlinear differential equation arising in nuclear physics*, Proc. Roy. Irish Acad. **62** (1963), 117–135.
- [84] W.M. Ni and J. Serrin, *Existence and nonexistence theorems for ground states of quasilinear partial differential equations. The anomalous case*, Convegno Celebrativo del Centenario della Nascita di Mauro Picone e di Leonida Tonelli, Atti dei Convegni Lincei, Vol. 77, Accademia Nazionale dei Lincei (1986), 231–257.
- [85] H.-O. Peitgen and K. Schmitt, *Perturbations globales topologiques des problemes nonlineaires de valeur propre*, Comptes Rendues Acad. Sci. Paris **291** (1980), 271–274.
- [86] H.-O. Peitgen and K. Schmitt, *Global topological perturbations of nonlinear elliptic eigenvalue problems*, Math. Methods Appl. Sci. **5** (1983), 376–388.
- [87] H.-O. Peitgen and K. Schmitt, *Global analysis of two-parameter elliptic eigenvalue problems*, Trans. Amer. Math. Soc. **283** (1984), 57–95.
- [88] L.A. Peletier and J. Serrin, *Ground states for the prescribed mean curvature equation*, Proc. Amer. Math. Soc. **100** (1987), 694–700.
- [89] S. Pohozaev, *Eigenfunctions of the equation $\Delta u + \lambda f(u) = 0$* , Sov. Math. Dokl. **165** (1965), 1408–1411.
- [90] M. Poppenberg, K. Schmitt and Z. Wang, *On the existence of soliton solutions to quasilinear Schrödinger equations*, Calc. Var. Partial Differential Equations **14** (2002), 329–344.
- [91] P. Pucci and J. Serrin, *A general variational identity*, Indiana Univ. Math. J. **35** (1986), 681–703.
- [92] P. Pucci and J. Serrin, *Critical exponents and critical dimensions for polyharmonic operators*, J. Math. Pures Appl. (9) **69** (1990), 55–83.
- [93] P. Rabinowitz, *On bifurcation from infinity*, J. Differential Equations **14** (1973), 462–475.
- [94] P. Rabinowitz, *Some aspects of nonlinear eigenvalue problems*, Rocky Mountain J. Math. **3** (1973), 161–202.
- [95] M. Rao and Z. Ren, *Theory of Orlicz Spaces*, Marcel Dekker, New York, 1985.
- [96] D.H. Sattinger, *Topics in Stability and Bifurcation Theory*, Lecture Notes in Math., Vol. 309, Springer-Verlag, 1973.
- [97] R. Schaaf and K. Schmitt, *A class of nonlinear Sturm–Liouville problems with infinitely many solutions*, Trans. Amer. Math. Soc. **306** (1988), 853–859.
- [98] R. Schaaf and K. Schmitt, *Asymptotic behavior of positive solution branches of semilinear elliptic problems with linear part at resonance*, Z. Angew. Math. Phys. **43** (1992), 645–676.
- [99] K. Schmitt, *Boundary value problems for quasilinear elliptic partial differential equations*, Nonlinear Anal. **2** (1978), 263–309.
- [100] K. Schmitt, *Positive solutions of semilinear elliptic boundary value problems*, Topological Methods in Differential Equations and Inclusions (Montreal, PQ, 1994), A. Granas, M. Frigon and G. Sabidussi, eds., Series C: Mathematical and Physical Sciences, Vol. 472, Kluwer Academic, Dordrecht (1995), 447–500.
- [101] K. Schmitt and Z.-Q. Wang, *On bifurcation from infinity for potential operators*, Differential Integral Equations **4** (1991), 933–944.
- [102] J. Serrin and H. Zou, *Symmetry of ground states of quasilinear elliptic equations*, Arch. Rat. Mech. Anal. **148** (1999), 265–290.
- [103] V.L. Shapiro, *Quasilinear ellipticity and the 1st eigenvalue*, Comm. Partial Differential Equations **16** (1991), 1819–1855.
- [104] E.A.D.B. Silva and S.H.M. Soares, *Liouville–Gelfand type problems for the N -Laplacian on bounded domains of R^N* , Ann. Scuola Norm. Sup. Pisa Cl. Sci. (4) **28** (1999), 1–30.
- [105] J. Smoller and A. Wasserman, *Symmetry breaking for positive solutions of semilinear elliptic equations*, Arch. Rat. Mech. Anal. **95** (1986), 217–225.
- [106] P.N. Srikanth, *Symmetry breaking for a class of semilinear elliptic problems*, Ann. Inst. H. Poincaré **7** (1990), 107–112.

- [107] T. Suzuki, *Radial and nonradial solutions for semilinear elliptic equations on circular domains*, Symposia Mathematica, Vol. XXX (Cortona, 1988), Academic Press, London (1989), 153–174.
- [108] N.S. Trudinger and X.-J. Wang, *Hessian measures. I*, Topol. Methods Nonlinear Anal. **10** (1997), 225–239.
- [109] K. Tso, *Remarks on critical exponents for Hessian operators*, Ann. Inst. H. Poincaré Anal. Non Linéaire **7** (1990), 113–122.
- [110] X.-J. Wang, *A class of fully nonlinear elliptic equations and related functionals*, Indiana Univ. Math. J. **43** (1994), 25–54.
- [111] M. Willem, *Minimax Theorems*, Birkhäuser, Boston (1996).

This Page Intentionally Left Blank

Integrability of Polynomial Differential Systems

Jaume Llibre

Departament de Matemàtiques, Universitat Autònoma de Barcelona, 08193 Bellaterra, Barcelona, Spain
E-mail: jllibre@mat.uab.es

Contents

1. Basic notions	439
1.1. Polynomial systems	440
1.2. First integrals and invariants	441
1.3. Integrating factors	442
1.4. Invariant algebraic curves	444
1.5. Exponential factors	446
2. Darbouxian theory of integrability	448
3. Kapteyn–Bautin theorem	452
4. On the degree of the invariant algebraic curves	454
5. Darboux lemma	460
6. Applications of the Darboux lemma	466
7. Algebraic limit cycles for quadratic systems	475
8. Limit cycles and algebraic limit cycles	480
9. Darbouxian theory of integrability and centres	485
10. Non-existence of limit cycles	487
11. The inverse problem	491
12. Elementary and Liouvillian first integrals	500
13. Liouvillian first integrals for the planar Lotka–Volterra system	503
14. On the integrability of two-dimensional flows	514
15. Darbouxian theory of integrability for polynomial vector fields on surfaces	518
15.1. Invariant algebraic curves and exponential factors	519
15.2. The surfaces	520
15.3. Darbouxian theory	524
References	528

This Page Intentionally Left Blank

Nonlinear ordinary differential equations appear in many branches of applied mathematics, physics and, in general, in applied sciences. For a differential system or a vector field defined on the plane \mathbb{R}^2 or \mathbb{C}^2 the existence of a first integral determines completely its phase portrait; of course, working with real or complex time, respectively. Since for such vector fields the notion of integrability is based on the existence of a first integral the following natural question arises:

Given a vector field on \mathbb{R}^2 or \mathbb{C}^2 , how to recognize if this vector field has a first integral?

The more easiest planar vector fields having a first integral are the Hamiltonian ones. The integrable planar vector fields which are not-Hamiltonian are, in general, very difficult to detect. Many different methods have been used for studying the existence of first integrals for non-Hamiltonian vector fields based on: Noether symmetries [13], the Darbouxian theory of integrability [38], the Lie symmetries [83], the Painlevé analysis [7], the use of Lax pairs [62], the direct method [51] and [55], the linear compatibility analysis method [97], the Carleman embedding procedure [14] and [2], the quasimonomial formalism [7], etc.

In this chapter we study the existence of first integrals for planar polynomial vector fields through the Darbouxian theory of integrability. The algebraic theory of integrability is a classical one, which is related with the first part of the Hilbert's 16th problem [56]. This kind of integrability is usually called Darbouxian integrability, and it provides a link between the integrability of polynomial vector fields and the number of invariant algebraic curves that they have (see [38,86]).

Darboux [38] showed how can be constructed the first integrals of planar polynomial vector fields possessing sufficient invariant algebraic curves. In particular, he proved that if a planar polynomial vector field of degree m has at least $[m(m+1)/2]$ invariant algebraic curves, then it has a first integral, which can be computed using these invariant algebraic curves. Jouanolou [58] (see also [95] and [31] for an easy proof) shows that if the number of invariant algebraic curves of a planar polynomial vector field of degree m is at least $[m(m+1)/2] + 2$, then the vector field has a rational first integral, and consequently all its solutions are invariant algebraic curves. For more details and results on Darbouxian theory of integration for planar polynomial vector fields, see [9,26,28,30,85,87,91–93].

Prelle and Singer [87] using methods of differential algebra, showed that if a polynomial vector field has an elementary first integral, then it can be computed using the Darbouxian theory of integrability. Singer [95] proved that if a polynomial vector field has Liouvillian first integrals, then it has integrating factors given by Darbouxian functions. Some related results can be found in [20].

1. Basic notions

In this section first we present the planar polynomial differential systems that we shall study. Secondly, we introduce the notion of first integral; and finally, we deal with the definition of integrating factor.

1.1. Polynomial systems

By definition a *planar polynomial differential system* or simply a *polynomial system* is a differential system of the form

$$\frac{dx}{dt} = \dot{x} = P(x, y), \quad \frac{dy}{dt} = \dot{y} = Q(x, y), \quad (1)$$

or equivalently

$$\frac{dy}{dx} = \frac{Q(x, y)}{P(x, y)},$$

where P and Q are polynomials in the variables x and y . Moreover, the dependent variables x and y , the independent variable t , and the coefficients of the polynomials P and Q are either all complex, or all real. In the former case the system is called a *complex polynomial system* and in the later a *real polynomial system*.

The independent variable t will be called the *time* of system (1).

If we have a real polynomial system (1) we will work with it as a complex one, independently if we want to study its real integrability, because as we will see later on, often the real integrability of a real polynomial system is forced by its complex structure.

In this chapter the *degree* m of the polynomial system (1) will be the maximum of the degrees of the polynomials P and Q .

Associated to polynomial system (1) there is either the *polynomial vector field*

$$\mathcal{X} = P(x, y) \frac{\partial}{\partial x} + Q(x, y) \frac{\partial}{\partial y}, \quad (2)$$

or the *polynomial 1-form*

$$\omega = P(x, y) dy - Q(x, y) dx.$$

The existence of solutions for the polynomial system (1), or equivalently for the polynomial vector field \mathcal{X} or for the 1-form ω is given by the Existence and Uniqueness theorem of solutions for an ordinary differential system.

If the polynomial system (1) is real, then a solution of it is an analytic function $\varphi: U \rightarrow \mathbb{R}^2$ (U is the maximal time open interval in which the solution is defined) such that $d\varphi(t)/dt = X(\varphi(t))$, for every $t \in U$.

If the polynomial system (1) is complex, then a solution of it is an analytic or holomorphic function $\varphi: U \rightarrow \mathbb{C}^2$ (U is the maximal time simple connected open subset of \mathbb{C} in which the solution is defined) such that $d\varphi(t)/dt = X(\varphi(t))$, for every $t \in U$.

In what follows we denote by \mathbb{F} either \mathbb{R} , or \mathbb{C} , according with system (1) be real or complex, respectively.

Let $\varphi: U \rightarrow \mathbb{F}^2$ be a solution of system (1). Then, the set $\{\varphi(t) \in \mathbb{F}^2: t \in U\}$ is called a *trajectory*, an *integral curve* or an *orbit* of system (1) or of the vector field \mathcal{X} .

1.2. First integrals and invariants

The vector field \mathcal{X} or equivalently the system (1) is *integrable* on an open subset U of \mathbb{F}^2 if there exists a nonconstant analytic function $H : U \rightarrow \mathbb{F}$, called a *first integral* of the system on U , which is constant on all solution curves $(x(t), y(t))$ of \mathcal{X} contained in U ; i.e., $H(x(t), y(t)) = \text{constant}$ for all values of t for which the solution $(x(t), y(t))$ is defined and contained in U . Clearly H is a first integral of \mathcal{X} on U if and only if

$$\mathcal{X}H = 0, \quad \text{or} \quad \omega \wedge dH = 0,$$

on U .

For system (1) defined on the plane \mathbb{R}^2 or \mathbb{C}^2 the existence of a first integral determines completely its phase portrait; i.e., the decomposition of the plane as union of the orbits of (1).

EXAMPLE 1.1. The polynomial system

$$\dot{x} = x(ax + c), \quad \dot{y} = y(2ax + by + c), \quad (3)$$

has the first integral

$$H = \frac{(ax + c)(ax + by)}{x(ax + by + c)}.$$

And the system

$$\dot{x} = -y - b(x^2 + y^2), \quad \dot{y} = x, \quad (4)$$

has the first integral

$$H = \exp(2by)(x^2 + y^2). \quad (5)$$

Of course, once we have a first integral any analytic function of this first integral is another first integral.

Let $U \subset \mathbb{F}^2$ be an open set. We say that an analytic function $H(x, y, t) : U \times \mathbb{F} \rightarrow \mathbb{F}$, is an *invariant* of the polynomial vector field \mathcal{X} on U , if $H(x, y, t) = \text{constant}$ for all values of t for which the solution $(x(t), y(t))$ is defined and contained in U . If an invariant H is independent on t then, of course, it is a first integral.

The knowledge provided by an invariant is weaker than the one provide by a first integral. The invariant, in general, only gives information about either the α - or the ω -limit set of the orbits of the system.

EXAMPLE 1.2. If $aB - bA = 0$ and $bC - Bc \neq 0$, then the polynomial system

$$\dot{x} = x(ax + by + c), \quad \dot{y} = y(Ax + By + C), \quad (6)$$

has the invariant

$$H = x^{B/(bC-Bc)} y^{-b/(bC-Bc)} e^t.$$

System (6) is the well-known Lotka–Volterra system, see [72,100].

1.3. Integrating factors

The simple fact of associating to system (1) the 1-form ω allows to obtain for the exact systems a first integral. Indeed, system (1) is called *exact* if it satisfies

$$\frac{\partial P}{\partial x} = -\frac{\partial Q}{\partial y}.$$

For these systems the 1-form ω is closed; i.e., $d\omega = 0$. Therefore, the function

$$H(x, y) = \int_{(x_0, y_0)}^{(x, y)} \omega,$$

obtained integrating ω through any path starting at the point (x_0, y_0) and ending at the point (x, y) is well defined, because ω is closed and \mathbb{F}^2 is simply connected. Then, $\omega = dH$. Hence, $\omega \wedge dH = 0$, and consequently H is a first integral for system (1).

The exact systems provides us a way to obtain first integrals for a given system (1) which initially is not exact, through the notion of integrating factor.

Let U be an open subset of \mathbb{F}^2 , and $R: U \rightarrow \mathbb{F}$ be an analytic function which is not identically zero on U . The function R is an *integrating factor* of the vector field \mathcal{X} , or of the 1-form ω , or of the system (1) on U if one of the following four equivalent conditions holds

$$\frac{\partial(RP)}{\partial x} = -\frac{\partial(RQ)}{\partial y},$$

$$\operatorname{div}(RP, RQ) = 0,$$

$$\mathcal{X}R = -R \operatorname{div}(\mathcal{X}),$$

$$d(R\omega) = d(RP \, dy - RQ \, dx) = 0, \tag{7}$$

on U . As usual the divergence of the vector field \mathcal{X} is defined by

$$\operatorname{div}(\mathcal{X}) = \operatorname{div}(P, Q) = \frac{\partial P}{\partial x} + \frac{\partial Q}{\partial y}.$$

The *first integral* H associated to the integrating factor R is given by

$$H(x, y) = - \int R(x, y) P(x, y) \, dy + h(x),$$

satisfying $\partial H / \partial x = -RQ$. Then

$$\dot{x} = RP = -\frac{\partial H}{\partial y}, \quad \dot{y} = RQ = \frac{\partial H}{\partial x}. \quad (8)$$

In order that this function H to be single-valued the open set U must be simply connected, if not it can be multi-valued.

Conversely, given a first integral H of the vector field \mathcal{X} we always can find an integrating factor R for which (8) holds.

EXAMPLE 1.3. It is easy to check that system (4) has the integrating factor $R = 2 \exp(2by)$, and that using it we get the first integral (5), and vice versa.

EXAMPLE 1.4. Linear differential equations. We consider the polynomial differential equation

$$\frac{dy}{dx} = a(x)y + b(x),$$

with a and b polynomials in x . Its associated 1-form is

$$\omega = dy - (a(x)y + b(x)) dx.$$

If $R = R(x)$ is an integrating factor it must satisfy

$$d(R\omega) = \left(\frac{\partial R}{\partial x} + Ra(x) \right) dx \wedge dy = 0.$$

Therefore, we get the integrating factor

$$R(x) = \exp\left(-\int a(x) dx\right).$$

Later on we shall use the following result.

PROPOSITION 1.5. *If a vector field \mathcal{X} has two integrating factors R_1 and R_2 on the open subset U of \mathbb{F}^2 , then in the open set $U \setminus \{R_2 = 0\}$ the function R_1/R_2 is a first integral.*

PROOF. Since R_i is an integrating factor, it satisfies that $\mathcal{X}R_i = -R_i \operatorname{div}(\mathcal{X})$ for $i = 1, 2$. Therefore, the proposition follows immediately from the next computation:

$$\mathcal{X}\left(\frac{R_1}{R_2}\right) = \frac{(\mathcal{X}R_1)R_2 - R_1(\mathcal{X}R_2)}{R_2^2} = 0.$$

□

1.4. Invariant algebraic curves

Let $f \in \mathbb{C}[x, y]$; i.e., f is a polynomial with complex coefficients in the variables x and y . The complex algebraic curve $f(x, y) = 0$ is an *invariant algebraic curve* of the real vector field \mathcal{X} if for some polynomial $K \in \mathbb{C}[x, y]$ we have

$$\mathcal{X}f = P \frac{\partial f}{\partial x} + Q \frac{\partial f}{\partial y} = Kf. \quad (9)$$

The polynomial K is called the *cofactor* of the invariant algebraic curve $f = 0$. We note that since the polynomial system has degree m , then any cofactor has at most degree $m - 1$.

We remark that in the definition of invariant algebraic curve $f = 0$ we always allow this curve to be complex; that is $f \in \mathbb{C}[x, y]$. As we will see this is due to the fact that sometimes for real vector fields the existence of a real first integral can be forced by the existence of complex invariant algebraic curves. Of course, when we look for a complex invariant algebraic curve of a real vector field we are thinking in the real vector field as a complex one.

Since on the points of the algebraic curve $f = 0$ the gradient $(\partial f/\partial x, \partial f/\partial y)$ of the curve is orthogonal to the vector field $\mathcal{X} = (P, Q)$ (see (9)), the vector field \mathcal{X} is tangent to the curve $f = 0$. Hence, the curve $f = 0$ is formed by trajectories of the vector field \mathcal{X} . This justifies the name of invariant algebraic curve given to the algebraic curve $f = 0$ satisfying (9) for some polynomial K , because it is *invariant* under the flow defined by \mathcal{X} .

EXAMPLE 1.6. It is easy to check that system (3) has the following five invariant algebraic curves, in this case straight lines: $f_1 = x = 0$, $f_2 = ax + c = 0$, $f_3 = y = 0$, $f_4 = ax + by = 0$, and $f_5 = ax + by + c = 0$, having cofactors $K_1 = ax + c$, $K_2 = ax$, $K_3 = 2ax + by + c$, $K_4 = ax + by + c$ and $K_5 = ax + by$, respectively. In fact, all integral curves of system (3) are algebraic because, with the exception of $f_1 = 0$ and $f_5 = 0$, they can be written as $(ax + c)(ax + by) - hx(ax + by + c) = 0$ being h a constant.

EXAMPLE 1.7. System (4) has only the two invariant algebraic curves $x + yi = 0$ and $x - yi = 0$, or equivalently the invariant algebraic curve $x^2 + y^2 = 0$, see Proposition 1.10. This is easy to proof using its first integral $H = \exp(2by)(x^2 + y^2)$.

PROPOSITION 1.8. *For a real polynomial system (1), $f = 0$ is an invariant algebraic curve with cofactor K if and only if $\bar{f} = 0$ is an invariant algebraic curve with cofactor \bar{K} . Here conjugation denotes conjugation of the coefficients of the polynomials only.*

PROOF. We assume that $f = 0$ is an invariant algebraic curve with cofactor K of the real polynomial system (1.9). Then equality (9) holds. Since P and Q are real polynomials conjugating equality (9) we obtain that

$$P \frac{\partial \bar{f}}{\partial x} + Q \frac{\partial \bar{f}}{\partial y} = \bar{K} \bar{f}.$$

Consequently, $\bar{f} = 0$ is an invariant algebraic curve with cofactor \bar{K} of system (1). The proof in the converse direction is similar. \square

LEMMA 1.9. *Let $f, g \in \mathbb{C}[x, y]$. We assume that f and g are relatively prime in the ring $\mathbb{C}[x, y]$. Then, for a polynomial system (1), $fg = 0$ is an invariant algebraic curve with cofactor K_{fg} if and only if $f = 0$ and $g = 0$ are invariant algebraic curves with cofactors K_f and K_g respectively. Moreover, $K_{fg} = K_f + K_g$.*

PROOF. It is clear that

$$\mathcal{X}(fg) = (\mathcal{X}f)g + f(\mathcal{X}g). \tag{10}$$

We assume that $fg = 0$ is an invariant algebraic curve with cofactor K_{fg} of system (1). Then, $\mathcal{X}(fg) = K_{fg}fg$ and from equality (10) we get $K_{fg}fg = (\mathcal{X}f)g + f\mathcal{X}g$. Therefore, since f and g are relatively prime, we obtain that f divides $\mathcal{X}f$, and g divides $\mathcal{X}g$. If we denote by $K_f = \mathcal{X}f/f$ and by $K_g = \mathcal{X}g/g$, then $f = 0$ and $g = 0$ are invariant algebraic curves of system (1) with cofactors K_f and K_g respectively, and $K_{fg} = K_f + K_g$.

The proof in the converse direction follows in a similar way using again (10). \square

PROPOSITION 1.10. *We suppose that $f \in \mathbb{C}[x, y]$ and let $f = f_1^{n_1} \cdots f_r^{n_r}$ be its factorization in irreducible factors over $\mathbb{C}[x, y]$. Then, for a polynomial system (1), $f = 0$ is an invariant algebraic curve with cofactor K_f if and only if $f_i = 0$ is an invariant algebraic curve for each $i = 1, \dots, r$ with cofactor K_{f_i} . Moreover $K_f = n_1 K_{f_1} + \cdots + n_r K_{f_r}$.*

PROOF. From Lemma 1.9, we have that $f = 0$ is an invariant algebraic curve with cofactor K_f if and only if $f_i^{n_i} = 0$ is an invariant algebraic curve for each $i = 1, \dots, r$ with cofactor $K_{f_i^{n_i}}$, furthermore $K_f = K_{f_1^{n_1}} + \cdots + K_{f_r^{n_r}}$.

Now for proving the proposition it is sufficient to show, for each $i = 1, \dots, r$, that $f_i^{n_i} = 0$ is an invariant algebraic curve with cofactor $K_{f_i^{n_i}}$ if and only if $f_i = 0$ is an invariant algebraic curve with cofactor K_{f_i} , and that $K_{f_i^{n_i}} = n_i K_{f_i}$. We assume that $f_i^{n_i} = 0$ is an invariant algebraic curve with cofactor $K_{f_i^{n_i}}$. Then

$$K_{f_i^{n_i}} f_i^{n_i} = \mathcal{X}(f_i^{n_i}) = n_i f_i^{n_i-1} \mathcal{X}(f_i),$$

or equivalently

$$\mathcal{X}(f_i) = \frac{1}{n_i} K_{f_i^{n_i}} f_i.$$

So defining $K_{f_i} = K_{f_i^{n_i}}/n_i$. We obtain that $f_i = 0$ is an invariant algebraic curve with cofactor K_{f_i} such that $K_{f_i^{n_i}} = n_i K_{f_i}$. The proof in the converse direction follows in a similar way. \square

An *irreducible* invariant algebraic curve $f = 0$ will be an invariant algebraic curve such that f is an irreducible polynomial in the ring $\mathbb{C}[x, y]$.

A natural question in this subject is whether a polynomial vector field has or not invariant algebraic curves. The answer is not easy, see the large section in Jouanolou’s book [58], or the long paper [79] devoted to show that one particular polynomial system has no invariant algebraic solutions. Even one of the more studied limit cycles, the limit cycle of the van der Pol system, until 1995 it was unknown that it is not algebraic [82]. Some results about the algebraic limit cycles of quadratic polynomial vector fields can be found in [21].

1.5. Exponential factors

In this section we introduce the notion of an exponential factor due to Christopher [28]. We shall see that an exponential factor appears when an invariant algebraic curve has in some sense multiplicity larger than 1. Therefore, as we shall show an exponential factor will play the same role than an invariant algebraic curve in order to obtain a first integral for the polynomial system (1).

We assume that we have two invariant algebraic curves $h = 0$ and $h + \varepsilon g = 0$ with cofactors K_h and $K_{h+\varepsilon g}$ and that ε is in a neighborhood of zero. Using that $\mathcal{X}h = K_h h$ and that $\mathcal{X}(h + \varepsilon g) = K_{h+\varepsilon g}(h + \varepsilon g)$, if we expand in power series of ε the cofactor $K_{h+\varepsilon g}$ we obtain that $K_{h+\varepsilon g} = K_h + \varepsilon K + O(\varepsilon^2)$, where K is some polynomial of degree at most $m - 1$.

Since

$$\begin{aligned} \mathcal{X}\left(\frac{h + \varepsilon g}{h}\right) &= \frac{\mathcal{X}(h + \varepsilon g)h - (h + \varepsilon g)\mathcal{X}h}{h^2} \\ &= \frac{K_{h+\varepsilon g}(h + \varepsilon g)h - (h + \varepsilon g)K_h h}{h^2} \\ &= \frac{(K_h + \varepsilon K + O(\varepsilon^2))(h + \varepsilon g)h - (h + \varepsilon g)K_h h}{h^2} \\ &= \varepsilon K + O(\varepsilon^2), \end{aligned}$$

we have

$$\begin{aligned} \mathcal{X}\left(\left(\frac{h + \varepsilon g}{h}\right)^{1/\varepsilon}\right) &= \frac{1}{\varepsilon}\left(\frac{h + \varepsilon g}{h}\right)^{1/\varepsilon}\left(1 + \varepsilon\frac{h}{g}\right)^{-1}\mathcal{X}\left(\frac{h + \varepsilon g}{h}\right) \\ &= \frac{1}{\varepsilon}\left(\frac{h + \varepsilon g}{h}\right)^{1/\varepsilon}(1 + O(\varepsilon))(\varepsilon K + O(\varepsilon^2)) \\ &= (K + O(\varepsilon))\left(\frac{h + \varepsilon g}{h}\right)^{1/\varepsilon}. \end{aligned} \tag{11}$$

Therefore the function

$$\left(\frac{h + \varepsilon g}{h}\right)^{1/\varepsilon}$$

has cofactor $K + O(\varepsilon)$. As ε tends to zero, the above expression tends to

$$\exp\left(\frac{g}{h}\right), \tag{12}$$

and from (11) we obtain that

$$\mathcal{X}\left(\exp\left(\frac{g}{h}\right)\right) = K \exp\left(\frac{g}{h}\right). \tag{13}$$

Therefore, function (12) satisfies the same Equation (9) that the invariant algebraic curves, with a cofactor of degree at most $m - 1$.

Let $h, g \in \mathbb{C}[x, y]$ and assume that h and g are relatively prime in the ring $\mathbb{C}[x, y]$. Then the function $\exp(g/h)$ is called an *exponential factor* of the \mathbb{F} -polynomial system (1) if for some polynomial $K \in \mathbb{C}[x, y]$ of degree at most $m - 1$ it satisfies Equation (13). As before we say that K is the *cofactor* of the exponential factor $\exp(g/h)$.

As we will see from the point of view of the integrability of polynomial systems (1) the importance of the exponential factors is double. On one hand, they verify Equation (13), and on the other hand, their cofactors are polynomials of degree at most $m - 1$. These two facts will allow that they play the same role that the invariant algebraic curves in the integrability of a polynomial system (1). We note that the exponential factors do not define invariant curves for the flow of system (1).

We remark that in the definition of exponential factor $\exp(g/h)$ we always allow that this function is complex; that is $h, g \in \mathbb{C}[x, y]$. This is due to the same reason that in the case of invariant algebraic curves. That is, sometimes for real polynomial systems the existence of a real first integral can be forced by the existence of complex exponential factors. Again when we look for a complex exponential factor of a real polynomial system we are thinking in the real polynomial vector field as a complex one.

PROPOSITION 1.11. *For a real polynomial system (1.9) the function $\exp(g/h)$ is an exponential factor with cofactor K if and only if the function $\exp(\bar{g}/\bar{h})$ is an exponential factor with cofactor \bar{K} . Again conjugation denotes conjugation of the coefficients of the polynomials only.*

PROOF. We assume that $\exp(g/h)$ is an exponential factor with cofactor K of the real polynomial system (1). Then equality (13) holds. Since P and Q are real polynomials conjugating equality (13) we obtain that

$$P \frac{\partial \exp(\bar{g}/\bar{h})}{\partial x} + Q \frac{\partial \exp(\bar{g}/\bar{h})}{\partial y} = \bar{K} \exp(\bar{g}/\bar{h}).$$

Consequently, $\exp(\bar{g}/\bar{h})$ is an exponential factor with cofactor \bar{K} of system (1). The proof in the converse direction is similar. □

PROPOSITION 1.12. *If $F = \exp(g/h)$ is an exponential factor for the polynomial system (1), then $h = 0$ is an invariant algebraic curve, and g satisfies the equation*

$$\mathcal{X}g = gK_h + hK_F,$$

where K_h and K_F are the cofactors of h and F respectively.

PROOF. Since $F = \exp(g/h)$ is an exponential factor with cofactor K_F , we have

$$K_F \exp\left(\frac{g}{h}\right) = \mathcal{X} \exp\left(\frac{g}{h}\right) = \exp\left(\frac{g}{h}\right) \mathcal{X}\left(\frac{g}{h}\right) = \exp\left(\frac{g}{h}\right) \frac{(\mathcal{X}g)h - g(\mathcal{X}h)}{h^2},$$

or equivalently

$$(\mathcal{X}g)h - g(\mathcal{X}h) = h^2 K_F.$$

Hence, since h and g are relatively prime, we obtain that h divides $\mathcal{X}h$. So $h = 0$ is an invariant algebraic curve with cofactor $K_h = \mathcal{X}h/h$. Now substituting $\mathcal{X}h$ by $K_h h$ in the last equality, we have that $\mathcal{X}g = gK_h + hK_F$. □

We remark that the exponential factors of the form $\exp(g/h)$ with $h = \text{constant}$ appear when the straight line at infinity is a solution with multiplicity higher than 1 for the projectivized version of the vector field, for additional details see [34].

2. Darbouxian theory of integrability

As far as we know, the problem of integrating a polynomial system by using its invariant algebraic curves was started to be considered by Darboux in [38]. The version that we present improves Darboux’s one essentially because here we also take into account the exponential factors (see [28]), the independent singular points (see [26]), and the invariants (see [9, 11]).

Before stating the main results of the Darboux theory of integrability we need some definitions. If $S(x, y) = \sum_{i+j=0}^{m-1} a_{ij} x^i y^j$ is a polynomial of degree $m - 1$ with $m(m + 1)/2$ coefficients in \mathbb{C} , then we write $S \in \mathbb{C}_{m-1}[x, y]$. We identify the linear vector space $\mathbb{C}_{m-1}[x, y]$ with $\mathbb{C}^{m(m+1)/2}$ through the isomorphism $S \rightarrow (a_{00}, a_{10}, a_{01}, \dots, a_{m-1,0}, a_{m-2,1}, \dots, a_{0,m-1})$.

We say that r points $(x_k, y_k) \in \mathbb{C}^2$, $k = 1, \dots, r$, are *independent* with respect to $\mathbb{C}_{m-1}[x, y]$ if the intersection of the r hyperplanes

$$\left\{ (a_{ij}) \in \mathbb{C}^{m(m+1)/2} : \sum_{i+j=0}^{m-1} x_k^i y_k^j a_{ij} = 0, k = 1, \dots, r \right\},$$

is a linear subspace of $\mathbb{C}^{m(m+1)/2}$ of dimension $m(m+1)/2 - r > 0$.

We recall that (x_0, y_0) is a singular point of system (1) if $P(x_0, y_0) = Q(x_0, y_0) = 0$.

We remark that the maximum number of isolated singular points of the polynomial system (1) is m^2 (by Bezout theorem), that the maximum number of independent isolated singular points of the system is $m(m+1)/2 - 1$, and that $m(m+1)/2 < m^2$ for $m \geq 2$.

A singular point (x_0, y_0) of system (1) is called *weak* if the divergence, $\text{div}(P, Q)$, of system (1) at (x_0, y_0) is zero.

THEOREM 2.1 (Darbouxian theory of integrability). *Suppose that a \mathbb{F} -polynomial system (1) of degree m admits p irreducible invariant algebraic curves $f_i = 0$ with cofactors K_i for $i = 1, \dots, p$, q exponential factors $\exp(g_j/h_j)$ with cofactors L_j for $j = 1, \dots, q$, and r independent singular points (x_k, y_k) such that $f_i(x_k, y_k) \neq 0$ for $i = 1, \dots, p$ and for $k = 1, \dots, r$. Note that the irreducible factors of the polynomials h_j are some f_i 's.*

- (a) *There exist $\lambda_i, \mu_j \in \mathbb{C}$ not all zero such that $\sum_{i=1}^p \lambda_i K_i + \sum_{j=1}^q \mu_j L_j = 0$, if and only if the (multi-valued) function*

$$f_1^{\lambda_1} \cdots f_p^{\lambda_p} \left(\exp\left(\frac{g_1}{h_1}\right) \right)^{\mu_1} \cdots \left(\exp\left(\frac{g_q}{h_q}\right) \right)^{\mu_q} \tag{14}$$

is a first integral of system (1.9), real if $\mathbb{F} = \mathbb{R}$.

- (b) *If $p + q + r = [m(m+1)/2] + 1$, then there exist $\lambda_i, \mu_j \in \mathbb{C}$ not all zero such that $\sum_{i=1}^p \lambda_i K_i + \sum_{j=1}^q \mu_j L_j = 0$.*
- (c) *If $p + q + r \geq [m(m+1)/2] + 2$, then system (1) has a rational first integral, and consequently all trajectories of the system are contained in invariant algebraic curves.*
- (d) *There exist $\lambda_i, \mu_j \in \mathbb{C}$ not all zero such that $\sum_{i=1}^p \lambda_i K_i + \sum_{j=1}^q \mu_j L_j = -\text{div}(P, Q)$, if and only if the function (14) is an integrating factor of system (1), real if $\mathbb{F} = \mathbb{R}$.*
- (e) *If $p + q + r = m(m+1)/2$ and the r independent singular points are weak, then function (14) for convenient $\lambda_i, \mu_j \in \mathbb{C}$ not all zero is a first integral if $\sum_{i=1}^p \lambda_i K_i + \sum_{j=1}^q \mu_j L_j = 0$, or an integrating factor if $\sum_{i=1}^p \lambda_i K_i + \sum_{j=1}^q \mu_j L_j = -\text{div}(P, Q)$.*
- (f) *There exist $\lambda_i, \mu_j \in \mathbb{C}$ not all zero such that $\sum_{i=1}^p \lambda_i K_i + \sum_{j=1}^q \mu_j L_j = -s$ for some $s \in \mathbb{F} \setminus \{0\}$, if and only if the function*

$$f_1^{\lambda_1} \cdots f_p^{\lambda_p} \left(\exp\left(\frac{g_1}{h_1}\right) \right)^{\mu_1} \cdots \left(\exp\left(\frac{g_q}{h_q}\right) \right)^{\mu_q} \exp(st) \tag{15}$$

is an invariant of system (1), real if $\mathbb{F} = \mathbb{R}$.

PROOF. We prove the theorem when the polynomial system (1) is complex. For the real case, we only do some minor comments.

We denote $F_j = \exp(g_j/h_j)$. By hypothesis we have p invariant algebraic curves $f_i = 0$ with cofactors K_i , and q exponential factors F_j with cofactors L_j . That is, the f_i 's satisfy $\mathcal{X} f_i = K_i f_i$, and the F_j 's satisfy $\mathcal{X} F_j = L_j F_j$.

The first part of statement (a) follows easily from the next computations

$$\begin{aligned} &\mathcal{X}(f_1^{\lambda_1} \dots f_p^{\lambda_p} F_1^{\mu_1} \dots F_q^{\mu_q}) \\ &= (f_1^{\lambda_1} \dots f_p^{\lambda_p} F_1^{\mu_1} \dots F_q^{\mu_q}) \left(\sum_{i=1}^p \lambda_i \frac{\mathcal{X} f_i}{f_i} + \sum_{j=1}^q \mu_j \frac{\mathcal{X} F_j}{F_j} \right) \\ &= (f_1^{\lambda_1} \dots f_p^{\lambda_p} F_1^{\mu_1} \dots F_q^{\mu_q}) \left(\sum_{i=1}^p \lambda_i K_i + \sum_{j=1}^q \mu_j L_j \right). \end{aligned}$$

In statement (a) we claim that the function (14) is real if \mathcal{X} is real. This follows from the following fact. Since \mathcal{X} is real, it is well known that if a complex invariant algebraic curve or exponential factor appears, then its conjugate must appear simultaneously (see Propositions 1.8 and 1.11). If among the invariant algebraic curves of \mathcal{X} a complex conjugate pair $f = 0$ and $\bar{f} = 0$ occurs, the function (14) has a real factor of the form $f^\lambda \bar{f}^{\bar{\lambda}}$, which is the multi-valued real function

$$[(\operatorname{Re} f)^2 + (\operatorname{Im} f)^2]^{\operatorname{Re} \lambda} \exp(-2 \operatorname{Im} \lambda \arg(\operatorname{Re} f + i \operatorname{Im} f)),$$

if $\operatorname{Im} \lambda \operatorname{Im} f \neq 0$. If among the exponential factors of \mathcal{X} a complex conjugate pair $F = \exp(h/g)$ and $\bar{F} = \exp(\bar{h}/\bar{g})$ occurs, the first integral (14) has a real factor of the form

$$\left(\exp\left(\frac{h}{g}\right) \right)^\mu \left(\exp\left(\frac{\bar{h}}{\bar{g}}\right) \right)^{\bar{\mu}} = \exp\left(2 \operatorname{Re}\left(\mu \frac{h}{g}\right)\right).$$

(b) Since the cofactors K_i and L_j are polynomials of degree $\leq m - 1$, we have that $K_i, L_j \in \mathbb{C}_{m-1}[x, y]$. We note that the dimension of $\mathbb{C}_{m-1}[x, y]$ as a vector space over \mathbb{C} is $m(m + 1)/2$.

Since (x_k, y_k) is a singular point of system (1), $P(x_k, y_k) = Q(x_k, y_k) = 0$. Then, from $\mathcal{X} f_i = P(\partial f_i / \partial x) + Q(\partial f_i / \partial y) = K_i f_i$, it follows that $K_i(x_k, y_k) f_i(x_k, y_k) = 0$. By assumption $f_i(x_k, y_k) \neq 0$, therefore $K_i(x_k, y_k) = 0$ for $i = 1, \dots, p$. Again, from $\mathcal{X} F_j = P(\partial F_j / \partial x) + Q(\partial F_j / \partial y) = L_j F_j$, it follows that $L_j(x_k, y_k) F_j(x_k, y_k) = 0$. Since $F_j = \exp(g_j/h_j)$ does not vanish, $L_j(x_k, y_k) = 0$ for $j = 1, \dots, q$. Consequently, since the r singular points are independent, all the polynomial K_i and L_j belong to a linear subspace S of $\mathbb{C}_{m-1}[x, y]$ of dimension $[m(m + 1)/2] - r$. We have $p + q$ polynomials K_i and L_j and since from the assumptions $p + q > [m(m + 1)/2] - r$, we obtain that the $p + q$ polynomials must be linearly dependent on S . So, there are $\lambda_i, \mu_j \in \mathbb{C}$ not all zero such that $\sum_{i=1}^p \lambda_i K_i + \sum_{j=1}^q \mu_j L_j = 0$. Hence statement (b) is proved.

(c) Since the number of independent singular points $r < m(m + 1)/2$, it follows that $p + q > 2$. Under the assumptions of statement (c) we apply statement (b) to two subsets of $p + q - 1 > 0$ functions defining invariant algebraic curves or exponential factors. Thus, we get two linear dependencies between the corresponding cofactors, which after some linear algebra and relabeling, we can write into the following form

$$M_1 + \alpha_3 M_3 + \dots + \alpha_{p+q-1} M_{p+q} = 0,$$

$$M_2 + \beta_3 M_3 + \dots + \beta_{p+q-1} M_{p+q} = 0,$$

where M_l are the cofactors K_i and L_j , and the α_l and β_l are complex numbers. Then, by statement (a), it follows that the two functions

$$\log(G_1 G_3^{\alpha_3} \dots G_{p+q}^{\alpha_{p+q}}), \quad \log(G_2 G_3^{\beta_3} \dots G_{p+q}^{\beta_{p+q}}),$$

are first integrals of system (1), where G_l is the polynomial defining an invariant algebraic curve or the exponential factor having cofactor M_l for $l = 1, \dots, p + q$. Then, taking logarithms to the above two first integrals, we obtain that

$$\begin{aligned} H_1 &= \log(G_1) + \alpha_3 \log(G_3) + \dots + \alpha_{p+q-1} \log(G_{p+q}), \\ H_2 &= \log(G_2) + \beta_3 \log(G_3) + \dots + \beta_{p+q-1} \log(G_{p+q}), \end{aligned}$$

are first integrals of system (1). Each provides an integrating factor R_i such that

$$R_i P = \frac{\partial H_i}{\partial y}, \quad R_i Q = -\frac{\partial H_i}{\partial x}.$$

Therefore, we obtain that

$$\frac{R_1}{R_2} = \frac{\partial H_1 / \partial x}{\partial H_2 / \partial x}.$$

Since the functions G_l are polynomials or exponentials of a quotient of polynomials, it follows that the functions $\partial H_i / \partial x$ are rational for $i = 1, 2$. So, from the last equality, we get that the quotient between the two integrating factors R_1 / R_2 is a rational function. From Proposition 1.5 it follows statement (c).

(d) We have $\lambda_i, \mu_j \in \mathbb{C}$ not all zero such that $\sum_{i=1}^p \lambda_i K_i + \sum_{j=1}^q \mu_j L_j = -\operatorname{div}(P, Q)$. Then, from the computations of the proof of statement (a), we obtain

$$\begin{aligned} &\mathcal{X}(f_1^{\lambda_1} \dots f_p^{\lambda_p} F_1^{\mu_1} \dots F_q^{\mu_q}) \\ &= (f_1^{\lambda_1} \dots f_p^{\lambda_p} F_1^{\mu_1} \dots F_q^{\mu_q}) \left(\sum_{i=1}^p \lambda_i K_i + \sum_{j=1}^q \mu_j L_j \right) \\ &= -(f_1^{\lambda_1} \dots f_p^{\lambda_p} F_1^{\mu_1} \dots F_q^{\mu_q}) \operatorname{div}(P, Q). \end{aligned}$$

So, from (7), statement (d) follows.

(e) Let $K = \operatorname{div}(P, Q)$, clearly $K \in \mathbb{C}_{m-1}[x, y]$. By assumption the r singular points (x_k, y_k) are weak, therefore $K(x_k, y_k) = 0$ for $k = 1, \dots, r$. So K belongs to the linear subspace S of the proof of statement (b).

On the other hand, since $\dim S = p + q = [m(m + 1)/2] - r \geq 0$ and we have $p + q + 1$ polynomials $K_1, \dots, K_p, L_1, \dots, L_q, K$ in S (we are using the same arguments that in

the proof of statement (b), it follows that these polynomials are linearly dependent on S . Therefore, we obtain $\lambda_i, \mu_j, \alpha \in \mathbb{C}$ not all zero such that

$$\left(\sum_{i=1}^p \lambda_i K_i \right) + \left(\sum_{j=1}^q \mu_j L_j \right) + \alpha K = 0. \tag{16}$$

If $\alpha = 0$ then, as in the proof of statement (a), we obtain that function (14) is a first integral of system (1).

We assume now that $\alpha \neq 0$. Dividing by α the equality (16) (if necessary), we can assume without loss of generality that $\alpha = 1$. So we have that

$$\sum_{i=1}^p \lambda_i K_i + \sum_{j=1}^q \mu_j L_j = -\text{div}(P, Q).$$

Then, by using statement (d) it follows (e).

(f) We have $\lambda_i, \mu_j \in \mathbb{C}$ not all zero such that $\sum_{i=1}^p \lambda_i K_i + \sum_{j=1}^q \mu_j L_j = -s$. Then, from

$$\begin{aligned} & \frac{d}{dt} (f_1^{\lambda_1} \dots f_p^{\lambda_p} F_1^{\mu_1} \dots F_q^{\mu_q} e^{st}) \\ &= \left(\mathcal{X} + \frac{\partial}{\partial t} \right) (f_1^{\lambda_1} \dots f_p^{\lambda_p} F_1^{\mu_1} \dots F_q^{\mu_q} e^{st}) \\ &= (f_1^{\lambda_1} \dots f_p^{\lambda_p} F_1^{\mu_1} \dots F_q^{\mu_q} e^{st}) \left(\sum_{i=1}^p \lambda_i K_i + \sum_{j=1}^q \mu_j L_j + s \right) = 0, \end{aligned}$$

it follows statement (f). □

A (multi-valued) function of the form (14) is called a *Darbouxian* function. The associated first integral to a Darbouxian integrating factor is called a *Liouvillian* first integral.

3. Kapteyn–Bautin theorem

An interesting application of the Darbouxian theory of integrability allows us to present a new and shorter proof of the sufficient conditions for the classification theorem of centers of quadratic polynomial differential systems due to Kapteyn [59,60] and Bautin [6]. The first proof of this fact was due to Kapteyn in the 1910s. The proof that we present here can be found in [9].

KAPTEYN–BAUTIN THEOREM. *Any quadratic system candidate to have a center can be written in the form*

$$\dot{x} = -y - bx^2 - Cxy - dy^2, \quad \dot{y} = x + ax^2 + Axy - ay^2. \tag{17}$$

This system has a center at the origin if and only if one of the following conditions holds

- (I) $A - 2b = C + 2a = 0$,
- (II) $C = a = 0$,
- (III) $b + d = 0$,
- (IV) $C + 2a = A + 3b + 5d = a^2 + bd + 2d^2 = 0$.

The following result gives a short proof of the sufficient conditions of Kapteyn–Bautin theorem.

THEOREM 4. *If system (17) satisfies one of the four conditions of the Kapteyn–Bautin theorem, then it has a center at the origin.*

PROOF. Since system (17) has a linear center at the origin, this is a center or a focus. Consequently, to prove that system (17) satisfying one of the four conditions of the Kapteyn–Bautin theorem has a center at the origin, it is sufficient to show that it has a first integral in a neighborhood of the origin.

Assume that system (17) satisfies condition (I). Then, it is easy to check that the system is Hamiltonian, i.e., $\dot{x} = -\partial H/\partial y$, $\dot{y} = \partial H/\partial x$ with $H = \frac{1}{2}(x^2 + y^2) + \frac{a}{3}x^3 + bx^2y - axy^2 + \frac{d}{3}y^3$. Therefore H is a first integral defined in a neighborhood of the origin.

Suppose that system (17) satisfies condition (II). Then, the system can be written in the form

$$\dot{x} = -y - bx^2 - dy^2, \quad \dot{y} = x + Ax y.$$

If $A \neq 0$ this system has the invariant straight line $f_1 = 1 + Ay = 0$ with cofactor $K_1 = Ax$. The divergence of the system is $(A - 2b)x$. Then, if $A(A - 2b) \neq 0$ we have the divergence of the system is equal to $(1 - \frac{2b}{A})K_1$. Hence, by Theorem 2.1(d) we obtain that $(1 + Ay)^{2b/A-1}$ is an integrating factor of system (17). Since this integrating factor is not zero at the origin, the associated first integral is defined in a neighborhood of the origin, and consequently the origin is a center.

We can assume that $A - 2b \neq 0$, otherwise we would be under the assumptions of condition (I). So, it remains only to study the case $A = 0$ and $b \neq 0$. Then, the system becomes $\dot{x} = -y - bx^2 - dy^2$, $\dot{y} = x$. This system has the algebraic solution $f_1 = 2b^2(bx^2 + dy^2) + (b - d)(2by - 1) = 0$ with cofactor $K_1 = -2bx$, which is equal to the divergence of the system. Therefore, by Theorem 2.1(d) we obtain that f_1^{-1} is an integrating factor. Hence the first integral associated to this integrating factor is defined at the origin if $b - d \neq 0$, and consequently the origin is a center.

Now we suppose that in addition $b - d = 0$. Then the system goes over to $\dot{x} = -y - b(x^2 + y^2)$, $\dot{y} = x$. From Examples 1.1 and 1.3 we know that $H = \exp(2by)(x^2 + y^2)$ is a first integral, which is defined at the origin, and therefore the origin must be a center.

Assume that system (17) satisfies condition (III). As Frommer observed in [44] (see also [92]) the form of system (17) with $b + d = 0$ is preserved under a rotation of axes. After performing a rotation of axes of an angle θ , the new coefficient a' of x^2 in the second equation of system (13) becomes of the form $a' = a \cos^3 \theta + \alpha \cos^2 \theta \sin \theta + \beta \cos \theta \sin^2 \theta + d \sin^3 \theta$.

Therefore, if $a \neq 0$ we can find θ such that $a' = 0$. So we can assume that $a = 0$, and consequently $C \neq 0$; otherwise we would be under the assumptions of condition (II).

The system

$$\dot{x} = -y - bx^2 - Cxy + by^2, \quad \dot{y} = x + Axy,$$

has the algebraic solutions $f_1 = 1 + Ay = 0$ if $A \neq 0$ with cofactor $K_1 = Ax$, and $f_2 = (1 - by)^2 + C(1 - by)x - b(A + b)x^2 = 0$ with cofactor $K_2 = -2bx - Cy$. Since the divergence of the system is equal to $K_1 + K_2$, by Theorem 2.1 (d) we obtain that $f_1^{-1} f_2^{-1}$ is an integrating factor. Hence, again the first integral associated to the integrating factor is defined at the origin, and consequently the origin is a center.

We remark that if $A = 0$ then f_1 is not an algebraic solution of the system, but then the divergence of the system is equal to K_2 and the integrating factor of the system is f_2^{-1} , and using the same arguments we obtain that the origin is a center.

Suppose that system (17) satisfies condition (IV). Then, if $d \neq 0$ the system becomes

$$\begin{aligned} \dot{x} &= -y + \frac{a^2 + 2d^2}{d}x^2 + 2axy - dy^2, \\ \dot{y} &= x + ax^2 + \frac{3a^2 + d^2}{d}xy - ay^2. \end{aligned}$$

We note that if $d = 0$ then we are under the assumptions of condition (II). This system has the algebraic solution $f_1 = (a^2 + d^2)[(dy - ax)^2 + 2dy] + d^2 = 0$ with cofactor $K_1 = 2(a^2 + d^2)x/d$. Therefore the divergence of the system is equal to $\frac{5}{2}K_1$. Hence, by Theorem 2.1(d) the function $f_1^{-5/2}$ is an integrating factor of the system. Since $d \neq 0$, its associated first integral is defined in a neighborhood of the origin, and consequently the origin is a center. \square

In order to see the explicit expression for the first integrals of system (17) satisfying conditions (I)–(IV), see Schlomiuk [92].

4. On the degree of the invariant algebraic curves

From Jouanolou's result (see Theorem 2.1(c)) it follows that for a given polynomial differential system of degree m the maximum degree of its irreducible invariant algebraic curves is bounded, since either it has a finite number $p < [m(m + 1)/2] + 2$ of invariant algebraic curves, or all its trajectories are contained in invariant algebraic curves and the system admits a rational first integral. Thus for each polynomial system there is a natural number N which bounds the degree of all its *irreducible* invariant algebraic curves. A natural question, going back to Poincaré [86], is to give an effective procedure to find N . Partial answers to this question were given by Cerveau and Lins Neto [16], Carnicer [15], Campillo and Carnicer [12], and Walcher [101]. These results depend on either restricting the nature of the polynomial differential system, or more specifically on the singularities of its invariant algebraic curves.

Of course, given such a bound, it is then easy to compute the algebraic curves of the system and also describe its elementary or Liouvillian first integrals (modulo any exponential factors) see for instance [73,28,84].

Unfortunately, for the class of polynomial systems with fixed degree m , there does not exist a uniform upper bound $N(m)$ for N as shown by the system:

$$\dot{x} = rx, \quad \dot{y} = sy,$$

with r and s be positive integers. This system has a rational first integral

$$H = \frac{y^r}{x^s}$$

and hence invariant algebraic curves $x^s - hy^r = 0$ for all $h \in \mathbb{C}$.

A common suggestion was that the following question would have a positive answer:

Given $m \geq 2$, is there a positive integer $M(m)$ such that if a polynomial vector field of degree m has an irreducible invariant algebraic curve of degree $\geq M(m)$, then it has a rational first integral.

See for instance the open question 2 in [31], or the question at the end of the introduction of [65].

The purpose of this section is to present two families of polynomial differential systems of degree 2 without rational first integrals but with irreducible invariant algebraic curves of arbitrarily high degree. Thus we show that no such function $M(m)$ exists.

THEOREM 4.1. *We consider the quadratic polynomial differential system*

$$\begin{aligned} \dot{x} &= x(1-x), \\ \dot{y} &= -\lambda y + Ax^2 + Bxy + y^2, \end{aligned} \tag{18}$$

where

$$\lambda = c - 1, \quad A = \frac{ab(c-a)(c-b)}{c^2}, \quad B = a + b - 1 - \frac{2ab}{c}.$$

If, for any positive integer k , we choose $a = 1 - k$, $b \leq a$, and c irrational, then the polynomial system (18) has:

- (a) *no rational first integrals;*
- (b) *an irreducible invariant algebraic curve*

$$\left(y - \frac{ab}{c}x\right)F + x(1-x)F' = 0,$$

- of degree k , where $F = F(a, b; c; x)$ is the hypergeometric function;*
- (c) *a Darbouxian integrating factor.*

PROOF. We first prove statement (a). We shall use the following result known by Poincaré [86]: *If a polynomial system (1.9) has a rational first integral, then the eigenvalues λ_1 and λ_2 associated to any singular point of the system must be resonant in the following sense: there exist nonnegative integers m_1 and m_2 with $m_1 + m_2 \geq 1$ such that $m_1\lambda_1 + m_2\lambda_2 = 0$.* For a proof see, for instance, [46] or [64]. Now it is easy to check that the origin of system (18) is a singular point whose ratio of eigenvalues is $1 - c$. Since c is irrational, the system can have no rational first integral.

The system (18) has the invariant solutions $x = 0$ and $x = 1$ together with the following two explicit solutions:

$$f_1 = \left(y - \frac{ab}{c}x\right)F_1 + x(1-x)F_1' = 0,$$

$$f_2 = \left(c - 1 - y + \left(1 - c + \frac{ab}{c}\right)x\right)F_2 - x(1-x)F_2' = 0,$$

where $F_1 = F(a, b; c; x)$, $F_2 = F(1 + a - c, 1 + b - c; 2 - c; x)$, and $F(a, b; c; x)$ is the hypergeometric function

$$F(a, b; c; x) = \sum_{k=0}^{\infty} \frac{(a)_k (b)_k}{(c)_k} \frac{x^k}{k!}.$$

Here we have used the notation

$$(a)_k = \begin{cases} 1, & \text{if } k = 0, \\ a(a + 1)(a + 2) \cdots (a + k - 1), & \text{if } k > 0. \end{cases}$$

The hypergeometric function $F(a, b; c; x)$ is a solution of the hypergeometric differential equation

$$x(1-x)y'' + [c - (a + b + 1)x]y' - aby = 0,$$

and so F and F' can have a common zero only at $x = 1$.

If we take $a = 1 - k$, $b \leq a$ and $c > 0$ irrational, with k a positive integer, then $F(a, b; c; x)$ is a polynomial of degree $k - 1$, with all coefficients positive. Hence $F(1) > 0$, and so F and F' can have no common roots at all. Thus $f_1 = 0$ defines an irreducible algebraic curve of degree k , which proves statement (b).

Finally, after some calculation it can be shown that

$$H = \frac{x^{c-1} f_1}{f_2}$$

is a first integral of the system, with (reciprocal) integrating factor

$$x^c f_1^2 (1-x)^{a+b+1-c}$$

which proves statement (c). □

Theorem 4.1 can be found in [32].

Moulin Ollagnier in [75] showed that the quadratic spatial homogeneous Lotka–Volterra systems in \mathbb{C}^3 :

$$\begin{aligned}\dot{x} &= x(Cy + z), \\ \dot{y} &= y(x + Az), \\ \dot{z} &= z(Bx + y),\end{aligned}\tag{19}$$

with

$$(A, B, C) = (-(2r + 1)/(2r - 1), 1/2, 2)$$

for $r = 1, 2, \dots$ has an invariant algebraic curve $f(x, y, z) = 0$ of degree $2r$. So these systems present invariant algebraic curves of unbounded degree. He added: *It is not easy to write f in “closed form”*.

This previous example is interesting because it was used by Moulin Ollagnier in [78] to provide another negative answer to the question about the existence of the number $M(m)$.

Now we want to understand the algebraic structure of the invariant algebraic curves of system (19), and at the same time we present a new proof of the existence of such invariant algebraic curves. The proof of the existence presented here is essentially analytical, while the proof of the existence given in [77,78] is algebraic.

The homogeneous Lotka–Volterra systems (19) in \mathbb{C}^3 can be thought as the planar projective model of the following planar Lotka–Volterra systems in \mathbb{C}^2 :

$$\begin{aligned}\dot{x} &= x\left(1 - \frac{x}{2} + y\right), \\ \dot{y} &= y\left(-\frac{2r+1}{2r-1} + \frac{x}{2} - y\right).\end{aligned}\tag{20}$$

For more details between the affine and the projective model of a planar polynomial vector fields, see for instance [77].

Let $f(x, y) \in \mathbb{C}[x, y]$. If $f = 0$ is an *invariant algebraic curve* of the polynomial differential system (20), then f satisfies the following linear partial differential equation

$$x\left(1 - \frac{x}{2} + y\right)\frac{\partial f}{\partial x} + y\left(-\frac{2r+1}{2r-1} + \frac{x}{2} - y\right)\frac{\partial f}{\partial y} = Kf,\tag{21}$$

where the polynomial K of degree ≤ 1 is the cofactor of $f = 0$.

THEOREM 4.2. *For any positive integer r system (20) has an invariant algebraic curve $f(x, y) = 0$ of degree $2r$ of the following form*

$$\begin{aligned}f(x, y) &= x^r y^r + (a_{r-1,r-1} + a_{r,r-1}x + a_{r+1,r-1}x^2)x^{r-1}y^{r-1} \\ &\quad + (a_{r-2,r-2} + a_{r-1,r-2}x + a_{r,r-2}x^2)x^{r-2}y^{r-2} \\ &\quad + \dots\end{aligned}$$

$$\begin{aligned}
 &+ (a_{1,1} + a_{2,1}x + a_{3,1}x^2)xy \\
 &+ (a_{0,0} + a_{1,0}x + a_{2,0}x^2), \tag{22}
 \end{aligned}$$

with cofactor $-x$. Moreover, an effective algorithm for the computation of $f(x, y)$ is given in the proof.

PROOF. For $r = 1, 2$ the following two polynomials

$$\begin{aligned}
 f(x, y) &= xy - \frac{1}{2}(4 - 4x + x^2), \\
 f(x, y) &= x^2y^2 + \frac{1}{6}(4 - 8x + 3x^2)xy - \frac{1}{9}(4 - 4x + x^2),
 \end{aligned}$$

provide, respectively, the invariant algebraic curves stated in the theorem. So, in the rest of the proof we assume that $r \geq 3$.

We consider the polynomial $f(x, y)$ written in the form $f(x, y) = f_0(x) + f_1(x)y + \dots + f_r(x)y^r$. Since $f = 0$ must be an invariant algebraic curve it must satisfy

$$\begin{aligned}
 &\left[x \left(1 - \frac{x}{2} \right) + xy \right] (f'_0(x) + f'_1(x)y + \dots + f'_r(x)y^r) \\
 &+ \left[y \left(-\frac{2r+1}{2r-1} + \frac{x}{2} \right) - y^2 \right] (f_1(x) + 2f_2(x)y + \dots + rf_r(x)y^{r-1}) \\
 &= -x(f_0(x) + f_1(x)y + \dots + f_r(x)y^r), \tag{23}
 \end{aligned}$$

where we are forcing that the cofactor of $f = 0$ is $-x$.

Equating to zero the coefficients of the different powers y^k in the expression (23) for $k = r + 1, r, \dots, 1, 0$, we obtain that the polynomials $f_j(x)$ for $j = 0, 1, \dots, r$ must satisfy the following ordinary differential system

$$\begin{aligned}
 &xf'_r(x) - rf_r(x) = 0, \\
 &xf'_j(x) - jf_j(x) = p_j(x), \quad \text{for } j = r - 1, r - 2, \dots, 1, 0, \\
 &\left(1 - \frac{x}{2} \right) f'_0(x) + f_0(x) = 0, \tag{24}
 \end{aligned}$$

where

$$p_j(x) = -x \left(1 - \frac{x}{2} \right) f'_{j+1}(x) - \left[(j+1) \left(-\frac{2r+1}{2r-1} + \frac{x}{2} \right) + x \right] f_{j+1}(x).$$

Using the first $r + 1$ equations of system (24) we can determine recursively $f_j(x)$ starting with $f_r(x)$ and ending with $f_0(x)$ as follows. After, we must verify that the function $f_0(x)$ obtained in this way satisfies the last equation of (24). Now, we will do these computations carefully.

The general solution of the first equation of system (24) is $f_r(x) = c_r x^r$, where c_r is the integration constant. Since we are looking for invariant algebraic curves $f(x, y)$ of the form (22), we take $c_r = 1$. Then, it is easy to see that the general solution of the differential equation $x f_j'(x) - j f_j(x) = p_j(x)$ is

$$f_j(x) = x^j \int \frac{p_j(x)}{x^{j+1}} dx. \quad (25)$$

So, solving (25) for $j = r - 1$, we get

$$f_{r-1} = \left[c_{r-1} + \frac{2r}{2r-1}x - \frac{1}{2}x^2 \right] x^{r-1},$$

where, in what follows, the integration constant which appears solving (25) is denoted by c_j . Solving again (25) but now for $j = r - 2$, we obtain

$$f_{r-2} = \left[c_{r-2} + \frac{2(r-1)}{2r-1}c_{r-1}x - \left[\frac{r}{(2r-1)^2} + \frac{1}{2}c_{r-1} \right] x^2 \right] x^{r-2}.$$

Now, we solve (8) for $j = r - 3$ and we have that f_{r-3} is equal to

$$\begin{aligned} c_{r-3} + \frac{2(r-2)c_{r-2}}{2r-1}x - \left[\frac{3(r-1)c_{r-1}}{(2r-1)^2} + \frac{c_{r-2}}{2} \right] x^2 \\ + \frac{2}{3} \left[\frac{r(r+1)}{(2r-1)^3} + \frac{c_{r-1}}{2r-1} \right] x^3 \end{aligned}$$

times x^{r-3} . In order to obtain for the polynomial $f(x, y)$ the structure given in the statement of the theorem, we choose the constant $c_{r-1} = -r(r+1)/(2r-1)^2$. Therefore, we get that

$$f_{r-3} = \left[c_{r-3} + \frac{2(r-2)c_{r-2}}{2r-1}x + \left[\frac{3r(r^2-1)}{(2r-1)^4} - \frac{c_{r-2}}{2} \right] x^2 \right] x^{r-3}.$$

We shall see that this structure that we have found computing $f_{r-3}(x)$, repeats until $f_0(x)$. More precisely, integrating Equation (25) for $j \leq r - 3$ and assuming that the expression of f_{j+1} is of the form

$$f_{j+1}(x) = \left[c_{j+1} + \alpha_{j+1}c_{j+2}x + \left[\beta_{j+1} - \frac{1}{2}c_{j+2} \right] x^2 \right] x^{j+1},$$

where the constants α and β depend on r , we have that

$$\begin{aligned} f_j(x) = \left[c_j + \frac{2(j+1)c_{j+1}}{2r-1}x + \left[\frac{(3-2(r-j))\alpha_{j+1}c_{j+2}}{2(2r-1)} - \frac{c_{j+1}}{2} \right] x^2 \right. \\ \left. + \frac{4\beta_{j+1}(2(1-r)+j) + (4(r-1) - (2r-1)\alpha_{j+1} - 2j)c_{j+2}}{6(2r-1)} x^3 \right] x^j. \end{aligned}$$

For obtaining the structure of the polynomial given in the statement of the theorem, we choose the value for the constant c_{j+2} in order that the coefficient of x^{j+3} in the last equality becomes zero; i.e.,

$$c_{j+2} = -\frac{4\beta_{j+1}(2(1-r) + j)}{4(r-1) - (2r-1)\alpha_{j+1} - 2j}.$$

We remark that the denominator of this expression never vanishes, otherwise j would be equal to $2r - 2$. Hence, we can write $f_j(x)$ into the form

$$f_j(x) = \left[c_j + \alpha_j c_{j+1} x + \left[\beta_j - \frac{1}{2} c_{j+1} \right] x^2 \right] x^j$$

for $j = r - 1, r - 2, \dots, 1, 0$. Notice that $\alpha_j = 2(j + 1)/(2r - 1)$. Clearly, when we reach $f_0(x)$ we have chosen values for the integrating constants c_j for $j = r - 1, r - 2, \dots, 2$, only the constants c_0 and c_1 remain arbitrary.

On the other hand, if we solve the last differential equation of system (24), we get that $f_0(x) = c(x - 2)^2$, where c is the integration constant. The polynomial $f(x, y)$ that we are determining solving the differential system (24) provides an invariant algebraic curve of system (20), if the two expressions obtained by $f_0(x)$ coincide; i.e.,

$$c_0 + \alpha_0 c_1 x + \left[\beta_0 - \frac{1}{2} c_1 \right] x^2 = c(x - 2)^2.$$

Taking

$$c = \frac{\alpha_0 \beta_0}{\alpha_0 - 2}, \quad c_0 = \frac{4\alpha_0 \beta_0}{\alpha_0 - 2}, \quad \text{and} \quad c_1 = \frac{4\beta_0}{\alpha_0 - 2},$$

both expressions are equal. Notice $\alpha_0 - 2 = 4(1 - r)/(2r - 1) \neq 0$. Hence, the proof of the theorem is completed. □

In the light of these two theorems, we have:

OPEN QUESTION 4.3. *There is some number $D(m)$ for which any polynomial differential system of degree m having some irreducible invariant algebraic curve of degree $> D(m)$ has a Darbouxian first integral or Darbouxian integrating factor.*

5. Darboux lemma

Darboux was the first to give the following relation of enumerative geometry [38, pp. 83–84]:

On peut rattacher cette recherche à un lemme relatif à six polynômes A, A', B, B', C, C' , de degrés l, l', m, m', n, n' satisfaisant à l'identité déjà considérée

$$(48) \quad AA' + BB' + CC' = 0;$$

il est évident que les degrés des produits AA' , BB' , CC' sont égaux.

On a donc déjà

$$l + l' = m + m' = n + n' = \lambda.$$

Cela posé, je dis que la somme du nombre des points communs aux trois courbes

$$A = 0, \quad B = 0, \quad C = 0,$$

et du nombre des points communs aux trois courbes

$$A' = 0, \quad B' = 0, \quad C' = 0,$$

est égale à

$$\frac{lmn + l'm'n'}{\lambda}.$$

We will refer to this result as the *Darboux lemma*; it can be stated more precisely as follows.

DARBOUX LEMMA. *Let \mathbb{K} be an algebraically closed field and let A, B, C, A', B', C' be six homogeneous polynomials of degrees l, m, n, l', m', n' in three variables with coefficients in \mathbb{K} such that:*

- (i) A, B, C are relatively prime and so are A', B', C' ,
- (ii) $l + l' = m + m' = n + n' = r$ and the orthogonality relation holds:

$$AA' + BB' + CC' = 0, \tag{26}$$

- (iii) the homogeneous ideal (A, B, C, A', B', C') generated by all six polynomials has no zero in the projective plane $\mathbb{P}_2(\mathbb{K})$.

Then, the homogeneous ideals generated by the triples (A, B, C) and (A', B', C') have only finitely many zeroes in the projective plane.

Denoting by h and h' the total multiplicities $I(A, B, C)$ and $I(A', B', C')$ of these homogeneous ideals in the projective plane, there is a relation between h, h' and the degrees:

$$h + h' = \frac{lmn + l'm'n'}{r} = r^2 - r(l + m + n) + (lm + mn + nl). \tag{27}$$

Darboux started the proof of his result as follows

En effet, soient h le nombre des points communs aux trois courbes A, B, C ; h' celui des points communs aux trois courbes A', B', C', \dots

This original proof is wrong; in particular, Darboux paid little attention to the last hypothesis (no common zeroes) and a counterexample is easy to find. Jouanolou noticed that Darboux's result was wrong and established clearly the formula (27) in his book [58, pp. 183–184], but his proof is far from being elementary. Jouanolou uses Chern's classes. Here, we present one of the two simple proofs given in [24]. Later on we shall apply Darboux lemma to polynomial differential equations.

In the proof that we present here we use standard facts about the intersection index of plane algebraic curves. This proof is divided into two steps. The first step deals with a

special case of the statement under extra assumptions and it follows the ideas of Darboux. The second step consists in reducing the general case to the special case in order to get the complete result.

In this section \mathbb{K} will denote an algebraically closed field. It will be convenient to denote an ideal generated in some polynomial ring over \mathbb{K} by the elements A_1, \dots, A_k simply by (A_1, \dots, A_k) . Other notations and definitions will be given when they become necessary.

We first recall some standard facts about homogeneous ideals of the polynomial ring $\mathbb{A} = \mathbb{K}[x_0, \dots, x_t]$, that have only a finite number of zeroes in the projective space $\mathbb{P}_t(\mathbb{K})$.

Let P be a point in the projective space $\mathbb{P}_t(\mathbb{K})$. The *local ring* \mathcal{O}_P can be defined in two ways. First, it is the subring of the field $\mathbb{K}(x_0, \dots, x_t)_0$ of homogeneous rational fractions of degree 0 consisting of all those with a denominator that does not vanish at P . Second, one of the projective coordinates of P does not vanish and there is no restriction in supposing $x_0(P) \neq 0$ to fix matters. Then the polynomial ring $\mathbb{K}[x_1, \dots, x_t]$ is isomorphic to the quotient ring of $\mathbb{K}[x_0, \dots, x_t]$ by its ideal generated by $x_0 - 1$, and \mathcal{O}_P is the local ring $S^{-1}\mathbb{K}[x_1, \dots, x_t]$, where S is the multiplicative set of all t -variable polynomials that do not vanish at P .

Let P be a point of $\mathbb{P}_t(\mathbb{K})$ and let \mathcal{I} be a homogeneous ideal of \mathbb{A} . The ideal \mathcal{I}_P is the ideal of the local ring \mathcal{O}_P generated by \mathcal{I} . If the quotient ring $\mathcal{O}_P/\mathcal{I}_P$ is a finite-dimensional vector space over \mathbb{K} , its dimension is called the *multiplicity* or the *intersection index* of \mathcal{I} at P ; $I_P(\mathcal{I})$ is a convenient notation for this number. In particular $I_P(\mathcal{I}) \neq 0$ means that P is a zero of \mathcal{I} . Thus, if \mathcal{I} is a homogeneous ideal with a finite number of zeroes in $\mathbb{P}_t(\mathbb{K})$, the sum $I(\mathcal{I}) = \sum_P I_P(\mathcal{I})$ over all zeroes of \mathcal{I} is well defined. It is called the *total multiplicity*, or the *total intersection index* or the *degree* of \mathcal{I} .

In the case of two or more *three-variable* homogeneous polynomials over \mathbb{K} , A_1, \dots, A_k the intersection index $I_P(A_1, \dots, A_k)$ at some point P of $\mathbb{P}_2(\mathbb{K})$ can be defined as the corresponding index for the homogeneous ideal generated by A_1, \dots, A_k . We note $I_P(A_1, \dots, A_k) = I_P((A_1, \dots, A_k))$.

In particular, if A_1, \dots, A_k (with $k \geq 2$) are relatively prime, then $I_P(A_1, \dots, A_k)$ is defined at every point P . On the other hand if they have a nontrivial greatest common divisor D , $I_P(A_1, \dots, A_k)$ is defined at all points P of $\mathbb{P}_2(\mathbb{K})$ where $D(P) \neq 0$.

Here are some standard properties of the intersection index whose proof can be found in the book of Fulton [45]. The first two are general:

- (i) $I_P(A_1, \dots, A_k)$ only depends on the ideal (A_1, \dots, A_k) of \mathbb{A} ,
- (ii) in fact, $I_P(A_1, \dots, A_k)$ only depends on the ideal generated by A_1, \dots, A_k in \mathcal{O}_P : if $B(P) \neq 0$, B is invertible in \mathcal{O}_P and $I_P(BA_1, A_2, \dots, A_k) = I_P(A_1, A_2, \dots, A_k)$.

The next two ones are specific to the three-variable case:

- (iii) If B has no nontrivial common factor with CC' , $I_P(B, CC') = I_P(B, C) + I_P(B, C')$ (Addition formula).
- (iv) If F and G are two homogeneous polynomials without nontrivial common factor, they have a finite number of common projective zeroes and $I(F, G) = \deg(F) \cdot \deg(G)$ (Bézout's theorem).

We will call a family $[A, B, C, A', B', C']$ of homogeneous polynomials in $\mathbb{K}[x, y, z]$ an *orthogonal system of polynomials* if

- (i) A, B, C are relatively prime, and so are A', B', C' ,
- (ii) $\deg(A) + \deg(A') = \deg(B) + \deg(B') = \deg(C) + \deg(C') = \rho(A, B, C, A', B', C')$, in which case $\rho(A, B, C, A', B', C')$ is called the *degree* of the system,
- (iii) the *orthogonality* condition (26) $AA' + BB' + CC' = 0$ holds.

We will say that an orthogonal system of polynomials $[A, B, C, A', B', C']$ is *without projective zero* if A, B, C, A', B', C' have no common zero in the projective plane.

If $[A, B, C, A', B', C']$ is an orthogonal system of polynomials, A, B, C are relatively prime and the total intersection index $I(A, B, C)$ is well-defined and so is $I(A', B', C')$.

Now denote the degrees of the polynomials A, B, C, A', B', C' by l, m, n, l', m', n' , respectively, and the degree of the orthogonal system $\rho(A, B, C, A', B', C')$ by r , to simplify the discussion.

The ratio

$$\frac{lmn + l'm'n'}{r} = r^2 - r(l + m + n) + (lm + mn + nl)$$

is a well-defined positive integer, which is 0 when $r = 0$. We then denote

$$\begin{aligned} \Delta(A, B, C, A', B', C') &= I(A, B, C) + I(A', B', C') - \frac{lmn + l'm'n'}{r} \\ &= h + h' - \frac{lmn + l'm'n'}{r}, \end{aligned}$$

and call this difference the *gap* of the orthogonal system.

With these definitions, the Darboux lemma can be stated as

The gap is zero for an orthogonal system of polynomials without projective zero.

We first give the result under the additional assumption that all six polynomials are pairwise relatively prime except maybe A and A' , B and B' , C and C' ; in other words, we suppose that there is no nontrivial common factor to AA', BB', CC' , and we then say that the orthogonal system is *irreducible*. This proof follows the ideas of Darboux. We will afterwards reduce the general case to this special case.

In our opinion, it is convenient and nonconfusing to identify a homogeneous nonzero three-variable polynomial F with the projective planar curve $F = 0$ it defines. We thus follow the free intuitive notations of Darboux.

For instance, the notation " $P \in A \cap B$ " means that the point P of $\mathbb{P}_2(\mathbb{K})$ is a common zero of the two homogeneous polynomials A and B and belongs to the intersection of the two curves $A = 0$ and $B = 0$, as well as the alternative notation " $A(P) = 0$ and $B(P) = 0$ ".

PROPOSITION 5.1. *Let $[A, B, C, A', B', C']$ be an irreducible orthogonal system of polynomials without projective zero. Then $\Delta(A, B, C, A', B', C') = 0$.*

PROOF. We first notice that $I_P(A, B, CC') = I_P(A, B, -AA' - BB') = I_P(A, B)$ at every point P of $\mathbb{P}_2(\mathbb{K})$. We want to prove the following equality at $P \in A \cap B$:

$$I_P(A, B) = I_P(A, B, CC') = I_P(A, B, C) + I_P(A, B, C'). \quad (28)$$

From the orthogonality relation (26), $P \in CC'$ and, by exchanging A, B, C by A', B', C' , there is no restriction in supposing $C(P) = 0$.

If $C'(P) \neq 0$, $I_P(A, B, C') = 0$. According to Section 2, $I_P(A, B, C) = I_P(A, B, CC') = I_P(A, B)$ and equality (28) holds in this case.

We now suppose that $C'(P) = 0$. Since $A \cap A' \cap B \cap B' \cap C \cap C' = \emptyset$, either $A'(P) \neq 0$ or $B'(P) \neq 0$ and there is no restriction in supposing $A'(P) \neq 0$. Then, $I_P(A, B, C) = I_P(A'A, B, C) = I_P(B, C)$, $I_P(A, B, C') = I_P(A'A, B, C') = I_P(B, C')$, $I_P(A, B, CC') = I_P(A'A, B, CC') = I_P(B, CC')$.

As B has no nontrivial common factor with C or C' , equality (28) follows from the addition formula of the intersection index: $I_P(B, CC') = I_P(B, C) + I_P(B, C')$. The use of the addition formula is the only place where the extra assumption that the orthogonal system is irreducible plays a role.

Summing intersection indices at all points $P \in A \cap B$, relation (28) leads to

$$\begin{aligned}
 lm = I(A, B) &= \sum_{P \in A \cap B} I_P(A, B) = \sum_{P \in A \cap B} I_P(A, B, CC') \\
 &= \sum_{P \in A \cap B} I_P(A, B, C) + \sum_{P \in A \cap B} I_P(A, B, C') = h + (lm - h), \tag{29}
 \end{aligned}$$

which means that the total intersection index $I(A, B, C')$ is $lm - h$.

Similar considerations lead to the next two equalities.

The first one,

$$\begin{aligned}
 ln' = I(A, C') &= \sum_{P \in A \cap C'} I_P(A, C') = \sum_{P \in A \cap C'} I_P(A, BB', C') \\
 &= \sum_{P \in A \cap C'} I_P(A, B, C') + \sum_{P \in A \cap C'} I_P(A, B', C') \\
 &= (lm - h) + (ln' - (lm - h)), \tag{30}
 \end{aligned}$$

means that the total intersection index $I(A, B', C')$ is $ln' - lm + h$.

The second one,

$$\begin{aligned}
 m'n' = I(B', C') &= \sum_{P \in B' \cap C'} I_P(B', C') = \sum_{P \in B' \cap C'} I_P(AA', B', C') \\
 &= \sum_{P \in B' \cap C'} I_P(A, B', C') + \sum_{P \in B' \cap C'} I_P(A', B', C') \\
 &= ln' - lm + h + h', \tag{31}
 \end{aligned}$$

means that the total intersection index $I(A', B', C')$ is $m'n' - ln' + lm - h$. From this last result, we deduce $\Delta(A, B, C, A', B', C') = 0$. □

In order to prove the Darboux lemma in the general case, we need a way to reduce non-irreducible orthogonal systems to irreducible ones. Let $[A, B, C, A', B', C']$ be a non-

irreducible orthogonal system of polynomials. The orthogonality relation easily implies that two polynomials of the same triple have a nontrivial great common divisor (gcd) and there is no restriction in supposing that $D = \gcd(A, B) \notin \mathbb{K}$ to describe what a reduction is.

According to the orthogonality relation, D also divides C' as it is coprime with C and we have $A = DA_1, B = DB_1, C' = DC'_1$, with $\gcd(A_1, B_1) = 1$. Then $[A_1, B_1, C, A', B', C'_1]$ is another orthogonal system of polynomials. If $[A, B, C, A', B', C']$ is without projective zero, so is $[A_1, B_1, C, A', B', C'_1]$. We say that $[A_1, B_1, C, A', B', C'_1]$ is a *one-step reduction* of $[A, B, C, A', B', C']$.

There are as many possible one-step reductions of an orthogonal system of polynomials as pairs of noncoprime polynomials of the same triple. Thus, after at most six successive one-step reductions, we get an irreducible orthogonal system that can be called *the complete reduction* of the original one.

The following lemma is then the key to deduce the general case of the Darboux lemma from the special case of irreducible orthogonal systems.

LEMMA 5.2. *Let $[A, B, C, A', B', C']$ be a nonirreducible orthogonal system of polynomials without projective zero and such that $D = \gcd(A, B) \notin \mathbb{K}$. If $[A_1, B_1, C, A', B', C'_1]$ is the corresponding one-step reduction of $[A, B, C, A', B', C']$ then $\Delta(A, B, C, A', B', C') = \Delta(A_1, B_1, C, A', B', C'_1)$.*

PROOF. Let us denote by s the degree of D , so that $\deg(A_1) = l_1 = l - s$, $\deg(B_1) = m_1 = m - s$, $\deg(C'_1) = n'_1 = n' - s$, $\rho(A_1, B_1, C, A', B', C'_1) = r_1 = r - s$. h_1 will stand for $I(A_1, B_1, C)$ and h'_1 for $I(A_1, B_1, C)$.

With these notations, after straightforward cancellations, proving the announced result amounts to proving

$$(h - h_1) + (h' - h'_1) = ns. \quad (32)$$

This relation (32) will come from $h - h_1 = ns$ and $h' - h'_1 = 0$.

We first show $h - h_1 = ns$ by proving the following equality for all $P \in A \cap B \cap C$:

$$I_P(A, B, C) = I_P(A_1, B_1, C) + I_P(D, C). \quad (33)$$

Let P belong to $D \cap C$. Since $A \cap A' \cap B \cap B' \cap C \cap C' = \emptyset$, either $A'(P) \neq 0$ or $B'(P) \neq 0$ and there is no restriction in supposing $A'(P) \neq 0$.

Let then D' be the greatest common divisor of B and C : $B = D'B_2, C = D'C_2$. As A, B, C are relatively prime, D' is relatively prime with D and it divides B_1 : $B_1 = D'B_3$; it also divides A' , thus $D'(P) \neq 0$. Then, $I_P(B, C)$ and $I_P(B_1, C)$ are well-defined and the following equalities hold:

$$I_P(A, B, C) = I_P(AA', B, C) = I_P(B, C),$$

$$I_P(A_1, B_1, C) = I_P(A_1A', B_1, C) = I_P(B_1, C).$$

Now, the addition formula of the intersection index gives

$$I_P(B, C) = I_P(B_2, C_2) = I_P(B_3, C_2) + I_P(D, C_2) = I_P(B_1, C) + I_P(D, C).$$

Thus, for a P in $D \cap C$, equality (33) holds.

Consider now a point P in $A \cap B \cap C$ that does not belong to D . Then $I_P(D, C) = 0$ whereas $I_P(A, B, C) = I_P(A_1, B_1, C)$ and equality (33) also holds.

Summing now equality (33) over all $P \in A \cap B \cap C$ gives

$$h = I(A, B, C) = I(A_1, B_1, C) + I(D, C) = h_1 + sn, \tag{34}$$

according to Bézout’s theorem.

Now we show that $h' - h'_1 = 0$ by proving $I_P(A', B', C') = I_P(A', B', C'_1)$ at all points P of $A' \cap B' \cap C'$.

If P belongs to $A' \cap B' \cap C'$ without being in D , then, we have that $I_P(A', B', C') = I_P(A', B', DC'_1) = I_P(A', B', C'_1)$.

If P belongs to $A' \cap B' \cap D$, then P does not belong to C and

$$\begin{aligned} I_P(A', B', C') &= I_P(A', B', CC') = I_P(A', B') \\ &= I_P(A', B', CC_1) = I_P(A', B', C'_1). \end{aligned}$$

□

We can now conclude.

COROLLARY 5.3 (Darboux lemma). *Let $[A, B, C, A', B', C']$ be an orthogonal system of polynomials without projective zero. Then $\Delta(A, B, C, A', B', C') = 0$.*

PROOF. If $[A_1, B_1, C_1, A'_1, B'_1, C'_1]$ is the complete reduction of $[A, B, C, A', B', C']$, then, according to Lemma 5.2, $\Delta(A, B, C, A', B', C')$ is the same as $\Delta(A_1, B_1, C_1, A'_1, B'_1, C'_1)$ and, according to Proposition 5.1, $\Delta(A_1, B_1, C_1, A'_1, B'_1, C'_1) = 0$ for an irreducible orthogonal system of polynomials. □

6. Applications of the Darboux lemma

Ideas in the remaining part of this section go back to Darboux’s work [38]. Let $p(x, y)$ and $q(x, y)$ be polynomials with complex coefficients. For the vector field

$$p \frac{\partial}{\partial x} + q \frac{\partial}{\partial y}, \tag{35}$$

or equivalently for the differential system

$$\dot{x} = p(x, y), \quad \dot{y} = q(x, y), \tag{36}$$

we consider the associated differential 1-form $\omega_1 = q(x, y) dx - p(x, y) dy$, and the differential equation

$$\omega_1 = 0. \quad (37)$$

Clearly, Equation (37) defines a foliation with singularities on \mathbb{C}^2 . The affine plane \mathbb{C}^2 is compactified on the complex projective space $\mathbb{C}\mathbb{P}^2 = (\mathbb{C}^3 \setminus \{0\})/\sim$, where $(X, Y, Z) \sim (X', Y', Z')$ if and only if $(X, Y, Z) = \lambda(X', Y', Z')$ for some complex $\lambda \neq 0$. The equivalence class of (X, Y, Z) will be denoted by $[X : Y : Z]$.

The foliation defined by equation (37) on \mathbb{C}^2 can be extended to a singular foliation on $\mathbb{C}\mathbb{P}^2$ and the 1-form ω_1 can be extended to a meromorphic 1-form ω on $\mathbb{C}\mathbb{P}^2$ which yields an equation $\omega = 0$, i.e.,

$$A(X, Y, Z) dX + B(X, Y, Z) dY + C(X, Y, Z) dZ = 0, \quad (38)$$

whose coefficients A, B, C are homogeneous polynomials and satisfy the relation:

$$A(X, Y, Z)X + B(X, Y, Z)Y + C(X, Y, Z)Z = 0. \quad (39)$$

Indeed, consider the map $i : \mathbb{C}^3 \setminus \{Z = 0\} \rightarrow \mathbb{C}^2$, given by $i(X, Y, Z) = (X/Z, Y/Z) = (x, y)$ and suppose that $\max\{\deg(p), \deg(q)\} = m > 0$. Since $x = X/Z$ and $y = Y/Z$ we have:

$$dx = (Z dX - X dZ)/Z^2, \quad dy = (Z dY - Y dZ)/Z^2,$$

the pull-back form $i^*(\omega_1)$ has poles at $Z = 0$ and Equation (37) can be written as

$$\begin{aligned} i^*(\omega_1) &= q(X/Z, Y/Z)(Z dX - X dZ)/Z^2 - p(X/Z, Y/Z)(Z dY - Y dZ)/Z^2 \\ &= 0. \end{aligned}$$

Then the 1-form $\omega = Z^{m+2}i^*(\omega_1)$ in $\mathbb{C}^3 \setminus \{Z \neq 0\}$ has homogeneous polynomial coefficients of degree $m + 1$, and for $Z = 0$ the equations $\omega = 0$ and $i^*(\omega_1) = 0$ have the same solutions. Therefore the differential equation $\omega = 0$ can be written as (38) where

$$\begin{aligned} A(X, Y, Z) &= ZQ(X, Y, Z) = Z^{m+1}q(X/Z, Y/Z), \\ B(X, Y, Z) &= -ZP(X, Y, Z) = -Z^{m+1}p(X/Z, Y/Z), \\ C(X, Y, Z) &= YP(X, Y, Z) - XQ(X, Y, Z). \end{aligned} \quad (40)$$

Clearly A, B and C are homogeneous polynomials of degree $m + 1$ satisfying (39).

Singular points in $\mathbb{P}_2(\mathbb{C})$ are the points satisfying $A = B = C = 0$.

A homogeneous 1-form

$$\omega = A dX + B dY + C dZ = 0,$$

where A, B and C are homogeneous polynomials of degree $m + 1$ is called *projective* if $XA + YB + ZC = 0$; that is, if there exist three homogeneous polynomials L, M and N of degree m such that

$$A = ZM - YN, \quad B = XN - ZL, \quad C = YL - XM;$$

or equivalently

$$(A, B, C) = (P, Q, R) \wedge (X, Y, Z).$$

Then we can write

$$\omega = P(Y dZ - Z dY) + Q(Z dX - X dZ) + R(X dY - Y dX). \tag{41}$$

The vector field

$$\mathcal{X} = P \frac{\partial}{\partial X} + Q \frac{\partial}{\partial Y} + R \frac{\partial}{\partial Z}, \tag{42}$$

can be thought as a *homogeneous polynomial vector field* of \mathbb{C}^3 of degree m associated to $\omega = 0$.

In short, we have seen that the homogeneous vector field (42) of degree m in \mathbb{C}^3 with

$$P = Z^m p(X/Z, Y/Z), \quad Q = Z^m q(X/Z, Y/Z), \quad R = 0, \tag{43}$$

is associated to the 1-form $\omega = 0$, and consequently to the vector field (35).

PROPOSITION 6.1 (Darboux proposition). *For any homogeneous polynomial vector field (42) of degree m in \mathbb{C}^3 having finitely many singular points and satisfying (43), we have that its number of singular points taking into account their multiplicities or numbers of intersection satisfies*

$$\sum_p I(p, P \cap Q \cap R) = m^2 + m + 1.$$

PROOF. Take $A = P, B = Q, C = R, A' = X, B' = Y$ and $C' = Z$. Then $AA' + BB' + CC' \equiv 0$. Since there are no common points to the curves $A' = 0, B' = 0$ and $C' = 0$ it follows that

$$h' = \sum_p I(p, A' \cap B' \cap C') = 0.$$

Therefore, from the Darboux lemma we obtain

$$h = \sum_p I(p, A \cap B \cap C) = \frac{(m + 1)^3 + 1}{m + 2} = m^2 + m + 1.$$

□

Let $f \in \mathbb{C}[x, y]$. The algebraic curve $f(x, y) = 0$ is an invariant algebraic curve of the affine polynomial vector field \mathcal{X} given by (35) if for some polynomial $k \in \mathbb{C}[x, y]$ (the cofactor of $f = 0$), we have

$$\mathcal{X}f = \frac{\partial f}{\partial x}p + \frac{\partial f}{\partial y}q = kf.$$

It is easy to verify that if $f(x, y) = 0$ is an invariant algebraic curve of degree r for the polynomial vector field \mathcal{X} with cofactor $k(x, y)$, then $F(X, Y, Z) = Z^r f(X/Z, Y/Z) = 0$ is an invariant algebraic curve of degree r for its projective vector field with cofactor $K(X, Y, Z) = Z^{m-1}k(X/Z, Y/Z)$; i.e.,

$$\mathcal{X}F = \frac{\partial F}{\partial X}P + \frac{\partial F}{\partial Y}Q + \frac{\partial F}{\partial Z}R = KF, \tag{44}$$

here $R = 0$.

If $F(X, Y, Z) = 0$ is an algebraic curve of $\mathbb{P}_2(\mathbb{C})$ of degree n . Let $p = (X_0, Y_0, Z_0)$ be a point of $\mathbb{P}_2(\mathbb{C})$. Since the three coordinates of p cannot be zero, without loss of generality we can assume that $p = (0, 0, 1)$. Then suppose that the expression of $F(X, Y, Z)$ restricted to $Z = 1$ is

$$F(X, Y, 1) = F_i(X, Y) + F_{i+1}(X, Y) + \dots + F_n(X, Y),$$

where $0 \leq i \leq n$ and $F_j(X, Y)$ denotes a homogeneous polynomial of degree j in the variables X and Y for $j = i, \dots, n$, with F_i different from the zero polynomial. We say that $i = m_p(F)$ is the *multiplicity* of the curve $F = 0$ at the point p . If $i = 0$ then the point p does not belong to the curve $F = 0$. If $i = 1$ we say that p is a *simple* point for the curve $F = 0$. If $i > 1$ we say that p is a *multiple* point.

PROPOSITION 6.2. *Let $f(x, y) = 0$ be an irreducible invariant algebraic curve of degree $n \geq 1$ without multiple points for the affine polynomial vector field \mathcal{X} of degree m . Then $n \leq m + 1$.*

PROOF. Since $F = 0$ is an invariant algebraic curve of \mathcal{X} with cofactor K we have that

$$\frac{\partial F}{\partial X}P + \frac{\partial F}{\partial Y}Q = KF$$

in $\mathbb{P}_2(\mathbb{C})$. By using Euler theorem for the homogeneous function F of degree n , this equation goes over to

$$\frac{\partial F}{\partial X}\left(P - \frac{1}{n}XK\right) + \frac{\partial F}{\partial Y}\left(Q - \frac{1}{n}YK\right) + \frac{\partial F}{\partial Z}\left(-\frac{1}{n}ZK\right) = 0. \tag{45}$$

Now we take in the Darboux lemma

$$A = \frac{\partial F}{\partial X}, \quad B = \frac{\partial F}{\partial Y}, \quad C = \frac{\partial F}{\partial Z},$$

$$A' = P - \frac{1}{n}XK, \quad B' = Q - \frac{1}{n}YK, \quad C' = -\frac{1}{n}ZK,$$

and

$$h = I(A \cap B \cap C), \quad h' = I(A' \cap B' \cap C').$$

We note that by the assumptions h and h' are finite. Moreover, as $A \cap B \cap C = \emptyset$, $h = 0$.

Since A, A', B, B', C and C' satisfy equality (45), Darboux lemma can be used to get

$$h + h' = \frac{m^3 + (n-1)^3}{m+n-1} = m^2 + (n-1)(n-m+1). \quad (46)$$

By the Bézout theorem, the number of intersection points of the curves $A' = 0$, $B' = 0$ and $C' = 0$ is at most m^2 taking into account their multiplicities; i.e., $h' \leq m^2$. Whence a lower bound for h : $0 = h \geq (n-1)(n-m-1)$, and $1 \leq n \leq m+1$. \square

In [23] it has been proved the following result that provides sufficient conditions for the existence of a rational first integral.

THEOREM 6.3. *Let $f(x, y) = 0$ be an irreducible algebraic curve of degree $n > 1$, which is invariant with cofactor $k \neq 0$, for the affine polynomial vector field \mathcal{X} of degree $m > 1$. If m^2 is the total number of solutions of the system*

$$nP - XK = 0, \quad nQ - YK = 0, \quad ZK = 0, \quad (47)$$

in the projective plane, taken into account their multiplicities or numbers of intersection, then \mathcal{X} has a rational first integral.

PROOF. Since m^2 is the number of solutions of system (47), by using Bezout theorem it follows that the number of solutions of systems

$$nP - XK = 0, \quad nQ - YK = 0, \quad Z = 0; \quad (48)$$

and

$$P = 0, \quad Q = 0, \quad K = 0; \quad (49)$$

are m and $m^2 - m$ respectively. We note that always we take into account the number of solutions with their multiplicities.

We write

$$\begin{aligned} P(X, Y, Z) &= p_0 Z^m + p_1(X, Y) Z^{m-1} + \cdots + p_m(X, Y), \\ Q(X, Y, Z) &= q_0 Z^m + q_1(X, Y) Z^{m-1} + \cdots + q_m(X, Y), \\ K(X, Y, Z) &= k_0 Z^{m-1} + k_1(X, Y) Z^{m-2} + \cdots + k_{m-1}(X, Y), \end{aligned}$$

where $A_i(x, y)$ denotes a homogeneous polynomial of degree i and $A \in \{p, q, k\}$. Then, for $Z = 0$ system (48) becomes

$$np_m(X, Y) - Xk_{m-1}(X, Y) = 0, \quad nq_m(X, Y) - Yk_{m-1}(X, Y) = 0.$$

Since this system of homogeneous polynomials of degree m in the variables X and Y intersect at m points taking into account their multiplicities, there exists a homogeneous polynomial $A(X, Y)$ of degree m such that

$$p_m(X, Y) = \lambda_1 A(X, Y) + \frac{1}{n} X k_{m-1}(X, Y),$$

$$q_m(X, Y) = \lambda_2 A(X, Y) + \frac{1}{n} Y k_{m-1}(X, Y),$$

where $\lambda_1, \lambda_2 \in \mathbb{C}$ are not zero.

The polynomial system associated to the vector field \mathcal{X} can be written as

$$\begin{aligned} \dot{x} &= p_0 + p_1(x, y) + \cdots + p_{m-1}(x, y) + \lambda_1 A(x, y) + \frac{x}{n} k_{m-1}(x, y) \\ &= P(x, y, 1), \\ \dot{y} &= q_0 + q_1(x, y) + \cdots + q_{m-1}(x, y) + \lambda_2 A(x, y) + \frac{1y}{n} k_{m-1}(x, y) \\ &= Q(x, y, 1), \end{aligned}$$

or equivalently

$$\begin{aligned} \dot{x} &= p_0 + p_1 + \cdots + p_{m-1} - \frac{1}{n} x(k_0 + k_1 + \cdots + k_{m-2}) + \lambda_1 A + \frac{1}{n} xk, \\ \dot{y} &= q_0 + q_1 + \cdots + q_{m-1} - \frac{1}{n} y(k_0 + k_1 + \cdots + k_{m-2}) + \lambda_2 A + \frac{1}{n} yk. \end{aligned}$$

Since $\lambda_1^2 + \lambda_2^2 \neq 0$ (otherwise system (48) does not have m intersection points), without loss of generality we can assume that $\lambda_1 \neq 0$. We change from the variables (x, y) to the variables (x, z) where $z = \lambda_2 x - \lambda_1 y$. In the new variables the second equation of the polynomial system goes over to

$$\dot{z} = \lambda_2 P(x, y, 1) - \lambda_1 Q(x, y, 1) = b(x, y) + \frac{1}{n} zk(x, y),$$

with $y = (\lambda_2 x - z)/\lambda_1$ and where

$$\begin{aligned} b(x, y) &= \lambda_2 \left(p_0 + p_1 + \cdots + p_{m-1} - \frac{1}{n} x(k_0 + k_1 + \cdots + k_{m-2}) \right) \\ &\quad - \lambda_1 \left(q_0 + q_1 + \cdots + q_{m-1} - \frac{1}{n} y(k_0 + k_1 + \cdots + k_{m-2}) \right). \end{aligned}$$

Since, from (49), the curves $\dot{x} = P(x, y, 1) = 0$, $\dot{y} = Q(x, y, 1) = 0$ and $K(x, y, 1) = k(x, y) = 0$ have $m^2 - m$ intersection points taking into account their multiplicities, it follows that the curves $P(x, y, 1) = 0$, $b(x, y) + k(x, y)z/n = 0$ and $k(x, y) = 0$ have the same number of intersection points, where $y = (\lambda_2x - z)/\lambda_1$. Hence, the number of intersection points of the curves $b(x, y) = 0$ and $k(x, y) = 0$ is at least $m^2 - m$ points taking into account their multiplicities. But, from Bézout theorem, if these last two curves do not have a common component, then they have $(m - 1)^2$ intersection points taking into account their multiplicities. Since $m^2 - m > (m - 1)^2$ if $m > 1$, it follows that the curves $b = 0$ and $k = 0$ have a maximal common component $c = 0$ of degree $r \geq 1$. Therefore, $b = \bar{b}c$ and $k = \bar{k}c$ where \bar{b} and \bar{k} are polynomials of degree $m - r - 1$.

From (47) the number of intersection points of the curves $P(x, y, 1) = 0$ and $Q(x, y, 1) = 0$ with $k(x, y) = 0$ is maximal, i.e., $m^2 - m$, then the number of intersection points of the curves $P(x, y, 1) = 0$, $Q(x, y, 1) = 0$ and $\bar{k}(x, y) = 0$ is $m(m - r - 1)$, and the number of intersection points of the curves $P(x, y, 1) = 0$, $Q(x, y, 1) = 0$ and $c(x, y) = 0$ is mr . Of course, always we compute the number of intersection points taking into account their multiplicities. Since the number of intersection points of the curves $P(x, y, 1) = 0$, $b(x, y) + k(x, y)z/n = 0$ and $\bar{k}(x, y) = 0$ is $m(m - r - 1)$, it follows that the number of intersection points of the curves $b(x, y) = 0$ and $\bar{k}(x, y) = 0$ is at least $m(m - r - 1)$. On the other hand, since the curves $b = 0$ and $\bar{k} = 0$ has no common components, by Bézout theorem they intersect at $(m - 1)(m - r - 1)$ points taking into account their multiplicities. Hence, since $m > 1$ and $m(m - r - 1) > (m - 1)(m - r - 1)$ except if $r = m - 1$, we have that $r = m - 1$. Therefore $b = ak$ with $a \in \mathbb{C}$. So, $\dot{z} = k(a + z/n)$, and consequently $z + an = \lambda_2x - \lambda_1y + an = 0$ is an invariant straight line with cofactor k/n . Then, by statement (a) of Theorem 2.1, we obtain that $H = f(x, y)(\lambda_2x - \lambda_1y + an)^{-n}$ is a rational first integral of \mathcal{X} . We note that since $f = 0$ is different by a straight line, we have that $f \neq (\lambda_2x - \lambda_1y + an)^n$, and consequently H is a first integral. □

From the proof of Theorem 6.3 it follows that any polynomial vector field \mathcal{X} in the assumptions of Theorem 6.3 has an invariant straight line $ax + by + c = 0$ such that a rational first integral of \mathcal{X} is of the form

$$\frac{f(x, y)}{(ax + by + c)^n}.$$

Now we go back to study the number of multiple points that an invariant algebraic curve of degree n of a polynomial vector field of degree m can have in function of m and n .

PROPOSITION 6.4. *Let $f(x, y) = 0$ be an invariant algebraic curve of degree n of the polynomial vector field*

$$\mathcal{X} = p(x, y)\frac{\partial}{\partial x} + q(x, y)\frac{\partial}{\partial y}$$

of degree m with cofactor k . Assume that:

If

$$P(X, Y, Z) = Z^m p\left(\frac{X}{Z}, \frac{Y}{Z}\right),$$

$$Q(X, Y, Z) = Z^m q\left(\frac{X}{Z}, \frac{Y}{Z}\right),$$

$$K(X, Y, Z) = Z^{m-1} k\left(\frac{X}{Z}, \frac{Y}{Z}\right),$$

then

- (1) the curves $nP - XK = 0$, $nQ - YK = 0$, $ZK = 0$, do not have a common component, and
- (2) the curve $F(X, Y, Z) = Z^n f(X/Z, Y/Z) = 0$ has finitely many multiple points in $\mathbb{P}_2(\mathbb{C})$ taking into account their multiplicities, namely h .

Then

$$(n - 1)(n - m - 1) \leq h \leq m^2 + (n - 1)(n - m - 1).$$

PROOF. Since $F = 0$ is an invariant algebraic curve of (44) with cofactor K we have that

$$\frac{\partial F}{\partial X} P + \frac{\partial F}{\partial Y} Q = KF$$

in $\mathbb{P}_2(\mathbb{C})$. By using Euler theorem for the homogeneous function F of degree n , this equation goes over to

$$\frac{\partial F}{\partial X} \left(P - \frac{1}{n} XK \right) + \frac{\partial F}{\partial Y} \left(Q - \frac{1}{n} YK \right) + \frac{\partial F}{\partial Z} \left(-\frac{1}{n} ZK \right) = 0. \tag{50}$$

Now we take

$$\begin{aligned} A &= \frac{\partial F}{\partial X}, & B &= \frac{\partial F}{\partial Y}, & C &= \frac{\partial F}{\partial Z}, \\ A' &= P - \frac{1}{n} XK, & B' &= Q - \frac{1}{n} YK, & C' &= -\frac{1}{n} ZK, \end{aligned}$$

and

$$h = \sum_p I(p, A \cap B \cap C), \quad h' = \sum_p I(p, A' \cap B' \cap C').$$

We note that by assumptions h and h' are finite.

Since A, A', B, B', C and C' satisfy equality (50), by Darboux lemma we obtain that

$$h + h' = \frac{m^3 + (n - 1)^3}{m + n - 1} = m^2 + (n - 1)(n - m + 1).$$

Therefore the upper bound for h given in the statement of the theorem is proved. By Bézout theorem, the number of intersection points of the curves $A' = 0$, $B' = 0$ and $C' = 0$ is at most m^2 taking into account their multiplicities; i.e., $h' \leq m^2$. Therefore, $h \geq (n - 1)(n - m - 1)$, and the proposition is proved. \square

From Proposition 6.4 it follows as a corollary Proposition 6.2.

COROLLARY 6.5. *Under the assumptions of Proposition 6.4, if $f(x, y) = 0$ is an invariant algebraic curve of degree $n = m + 1$ for the polynomial vector field \mathcal{X} of degree $m > 1$ such that its projectivization $F(X, Y, Z) = Z^n f(X/Z, Y/Z) = 0$ has no multiple points, then \mathcal{X} has a rational first integral.*

PROOF. Using the same notation than in the proof of Proposition 6.4 we have that $h' = m^2$, because from the assumptions we have that $n = m + 1$ and $h = 0$. Now, since we are in the hypotheses of Theorem 6.3 the statement of the corollary follows. \square

The last result in this section about rational first integrals is the following one.

PROPOSITION 6.6. *Under the assumptions of Proposition 6.4, if $f(x, y)$ is irreducible in $\mathbb{C}[x, y]$ and all the multiple points of $F(X, Y, Z) = 0$ are double and ordinary, then $n \leq 2m$. Moreover, if $n = 2m$ then \mathcal{X} has a rational first integral.*

PROOF. We use the notation and the results introduced in the proof of Proposition 6.4. Since every multiple point p of $F(X, Y, Z) = 0$ is double and ordinary, it follows that

$$I\left(p, \frac{\partial F}{\partial X} \cap \frac{\partial F}{\partial Y} \cap \frac{\partial F}{\partial Z}\right) = 1. \tag{51}$$

If $F = 0$ is an irreducible algebraic curve of degree n , we know that

$$\sum_p \frac{1}{2} m_p (m_p - 1) \leq \frac{1}{2} (n - 1)(n - 2), \tag{52}$$

where p runs over the multiple points of $F = 0$ and m_p denotes the multiplicity of p , for a proof of this result see Section 4 of Chapter 5 of [46]. Since every multiple point p of $F = 0$ is double, $m_p = 2$. If h is the number of multiple points of $F = 0$ taking into account their multiplicity, from (51) and (52), it follows that $h \leq (n - 1)(n - 2)/2$. By Proposition 6.4, we have $(n - 1)(n - m - 1) \leq h$. Consequently

$$(n - 1)(n - m - 1) \leq \frac{1}{2} (n - 1)(n - 2).$$

Hence $n \leq 2m$, and the first part of the proposition is proved.

Now we assume that $n = 2m$. From the proof of Proposition 6.4 we have that $h + h' = m^2 + (n - 1)(n - m - 1) = m^2 + (2m - 1)(m - 1)$. Then since $h \leq (n - 1)(n - 2)/2 =$

$(2m - 1)(m - 1)$, we obtain that $h' \geq m^2$. But, by definition, $h' \leq m^2$. Hence, we are in the assumptions of Theorem 6.3, and consequently \mathcal{X} has a rational first integral. \square

7. Algebraic limit cycles for quadratic systems

We recall that a *limit cycle* of a real affine polynomial vector fields is an isolated periodic orbit in the set of all periodic orbits of the system. An *algebraic limit cycle* of degree r is an oval of an irreducible invariant algebraic curve $f(x, y) = 0$ of degree r which is a limit cycle of the system.

In 1958 Qin Yuan-Xun [88] (see also [104]) proved that quadratic systems can have algebraic limit cycles of degree 2, moreover when such a limit cycle exists then it is the unique limit cycle of the system. Evdokimenco in [40–42] proved that quadratic systems do not have algebraic limit cycles of degree 3, for two different shorter proofs see [22,25]. We provide one of these proofs in what follows.

THEOREM 7.1. *Quadratic systems have no algebraic limit cycles of degree 3.*

PROOF. Let $f = 0$ be an invariant algebraic curve of degree 3 of a real affine polynomial vector field of degree 2. If the cubic curve $f = 0$ has multiple points, then it is rational (its genus is 0) and there is no oval in it. If $f = 0$ has no multiple points, Equation (46) in the proof of Proposition 6.2 implies $h' = 2^2 = 4$. According to Theorem 6.3, the system has a rational first integral and thus no limit cycle. \square

The first class of algebraic limit cycles of degree 4 was given in 1966 by Yablonskii [103]. The second class was found in 1973 by Filiptsov [43]. Recently, two new classes has been found and in [25] the authors proved that there are no other algebraic limit cycles of degree 4 for quadratic systems. The uniqueness of these limit cycles has been proved in [21]. We summarize all these results into the following theorem, for a proof see the mentioned papers.

THEOREM 7.2. *The following statements hold.*

- (a) *After an affine change of variables and a rescaling of the time variable the only quadratic systems having an algebraic limit cycle of degree 2 are*

$$\begin{aligned}\dot{x} &= -y(ax + by + c) - (x^2 + y^2 - 1), \\ \dot{y} &= x(ax + by + c),\end{aligned}\tag{53}$$

with $c^2 + 4(b + 1) < 0$ and $a^2 + b^2 < c^2$. This system possesses the irreducible invariant algebraic curve

$$x^2 + y^2 - 1 = 0,$$

of degree 2. This algebraic limit cycle is the unique limit cycle of system (18).

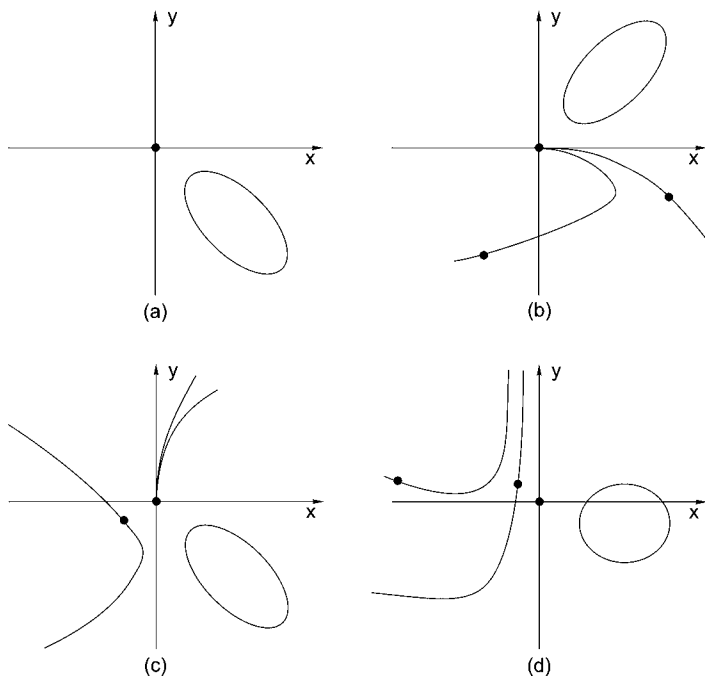

Fig. 1. Algebraic limit cycles of degree 4.

(b) *There are no quadratic systems having algebraic limit cycles of degree 3.*

(c) *After an affine change of variables the only quadratic systems having an algebraic limit cycle of degree 4 are*

(c.1) *Yablonskii's system*

$$\begin{aligned} \dot{x} &= -4abcx - (a + b)y + 3(a + b)cx^2 + 4xy, \\ \dot{y} &= (a + b)abx - 4abcy + (4abc^2 - 3(a + b)^2/2 + 4ab)x^2 \\ &\quad + 8(a + b)cx + 8y^2, \end{aligned} \tag{54}$$

with $abc \neq 0$, $a \neq b$, $ab > 0$ and $4c^2(a - b)^2 + (3a - b)(a - 3b) < 0$. This system possesses the irreducible invariant algebraic curve

$$(y + cx^2)^2 + x^2(x - a)(x - b) = 0, \tag{55}$$

of degree 4 having two components, an oval (the algebraic limit cycle) and an isolated point (a singular point), see Figure 1(a).

(c.2) *Filipsov's system*

$$\begin{aligned} \dot{x} &= 6(1 + a)x + 2y - 6(2 + a)x^2 + 12xy, \\ \dot{y} &= 15(1 + a)y + 3a(1 + a)x^2 - 2(9 + 5a)xy + 16y^2, \end{aligned} \tag{56}$$

with $0 < a < 3/13$. This system possesses the irreducible invariant algebraic curve

$$3(1+a)(ax^2+y)^2+2y^2(2y-3(1+a)x)=0,$$

of degree 4 having two components, one is an oval and the other is homeomorphic to a straight line. This last component contains three singular points of the system, see Figure 1(b).

(c.3) The system

$$\begin{aligned}\dot{x} &= 5x + 6x^2 + 4(1+a)xy + ay^2, \\ \dot{y} &= x + 2y + 4xy + (2+3a)y^2,\end{aligned}\tag{57}$$

with $(-71 + 17\sqrt{17})/32 < a < 0$ possesses the irreducible invariant algebraic curve

$$x^2 + x^3 + x^2y + 2axy^2 + 2axy^3 + a^2y^4 = 0,$$

of degree 4 having three components, one is an oval and each of the other two is homeomorphic to a straight line. Each one of these last two components contains one singular point of the system, see Figure 1(c).

(c.4) The system

$$\begin{aligned}\dot{x} &= 2(1+2x-2ax^2+6xy), \\ \dot{y} &= 8-3a-14ax-2axy-8y^2,\end{aligned}\tag{58}$$

with $0 < a < 1/4$ possesses the irreducible invariant algebraic curve

$$\frac{1}{4} + x - x^2 + ax^3 + xy + x^2y^2 = 0,\tag{59}$$

of degree 4 having three components, one is an oval and each of the other two is homeomorphic to a straight line. Each one of these last two components contains one singular point of the system, see Figure 1(d).

(d) Quadratic systems (53), (54), (56), (57) and (58) have a unique limit cycle, the algebraic one.

We note that the algebraic limit cycle of Filiptsov's system is born in a Hopf bifurcation at the singular point $(4, 48/13)$ when $a = 3/13$. Then, when a decreases the algebraic limit cycle increases its size and ends having infinite size at the curve $y^2(3-6x+4y) = 0$ when $a = 0$.

We note that the algebraic limit cycle of system (c.3) is born in a Hopf bifurcation at the singular point $((9-\sqrt{17})/8, -(5+3\sqrt{17})/8)$ when $a = (-71+17\sqrt{17})/32$. Then, when a increases the algebraic limit cycle increases its size and ends having infinite size at the curve $x^2(1+x+y) = 0$ when $a = 0$.

We note that the algebraic limit cycle of system (c.4) is born in a Hopf bifurcation at the singular point $(2, -1/4)$ when $a = 1/4$. Then, when a decreases the algebraic limit cycle increases its size and ends having infinite size at the irreducible curve $1/4 + x - x^2 + xy + x^2y^2 = 0$ when $a = 0$.

The uniqueness of limit cycles for planar differential systems is a classical problem which, in general, does not have an easy solution, for more details see the books of Ye Yanqian [104] and Zhang Zhifen [105].

Now following the paper [35] we apply a change of variables to the known quadratic systems having an algebraic limit cycle, which preserves the degree of the system, but increases the degree of the algebraic curve. For this purpose we use the birational transformation

$$(x, y) \rightarrow (x/y^2, 1/y), \tag{60}$$

after an appropriate translation. In fact, this transformation is an involution.

If the system is of the form

$$\begin{aligned} \dot{x} &= \alpha x + \beta y + 2ex^2 + bxy + cy^2, \\ \dot{y} &= \gamma x + \delta y + exy + fy^2, \end{aligned} \tag{61}$$

then it is easy to see that we can apply the transformation above and still remain in the class of quadratic systems.

As a simple example, we show that the example of Yablonskii with an algebraic limit cycle of degree 4 can be obtained from the well-known example of an algebraic limit cycle of degree 2 due to Qin Yuan-Xun [88].

PROPOSITION 7.3. *The system of Yablonskii (54) with its irreducible invariant algebraic curve (55) can be transformed into the system*

$$\begin{aligned} \dot{x} &= -3(a + b)cx + 4abcx^2 - 4y + (a + b)xy, \\ \dot{y} &= (a(b + 4bc^2) - (3a^2 + 3b^2)/2)x + 2(a + b)cy + ab(a + b)x^2 \\ &\quad + 4abcxy + 2(a + b)y^2, \end{aligned}$$

with the invariant algebraic curve

$$-\frac{(a - b)^2}{4ab} + ab\left(x - \frac{a + b}{2ab}\right)^2 + (y + c)^2 = 0, \tag{62}$$

by the transformation $(x, y) \rightarrow (1/x, y/x^2)$.

The algebraic curves (55) and (62) both give limit cycles when $abc \neq 0$, $a \neq b$, $ab > 0$, and $4c^2(a - b)^2 + (3a - b)(a - 3b) < 0$, and the transformation maps the one limit cycle onto the other.

We now apply the birational transformation to system (58) having the irreducible invariant algebraic curve (59) which defines an algebraic limit cycle of degree 4 for $0 < a < 1/4$, and we get a quadratic system having an algebraic limit cycle of degree 5.

THEOREM 7.4. *System*

$$\begin{aligned}\dot{x} &= 28x - \frac{12}{\alpha + 4}y^2 - 2(\alpha^2 - 16)(12 + \alpha)x^2 + 6(3\alpha - 4)xy, \\ \dot{y} &= (32 - 2\alpha^2)x + 8y - (\alpha + 12)(\alpha^2 - 16)xy + (10\alpha - 24)y^2,\end{aligned}\quad (63)$$

has an irreducible algebraic invariant curve of degree 5 given by

$$\begin{aligned}x^2 + (16 - \alpha^2)x^3 + (\alpha - 2)x^2y + \frac{1}{(4 + \alpha)^2}y^4 - \frac{6}{(4 + \alpha)^2}y^5 - \frac{2}{4 + \alpha}xy^2 \\ + \frac{(\alpha - 4)(12 + \alpha)}{4}x^2y^2 + \frac{(12 + \alpha)}{4 + \alpha}xy^4 + \frac{8 - \alpha}{4 + \alpha}xy^3 = 0.\end{aligned}\quad (64)$$

For $\alpha \in (3\sqrt{7}/2, 4)$ the curve (64) contains an algebraic limit cycle of degree 5.

PROOF. Let $a = 16 - \alpha^2$. When we make the change of coordinates

$$(x, y) = \left(\frac{u}{v^2} - \frac{1}{\alpha + 4}, \frac{1}{v} + \frac{\alpha - 2}{2} \right), \quad (65)$$

multiply by v , and replace (u, v) again with (x, y) , system (58) becomes (63). The curve (64) is obtained from (59) by means of the same change of coordinates and multiplication by v^6 . The irreducibility of (64) follows from the irreducibility of (59).

Since the curve (59) contains an algebraic limit cycle for $a \in (0, 1/4)$, one may easily check, that the above oval does not intersect the singular line of the transformation (65), so the theorem follows. \square

In a similar way we have the following result.

THEOREM 7.5. *System*

$$\begin{aligned}\dot{x} &= 28(\beta - 30)\beta x + y + 168\beta^2x^2 + 3xy, \\ \dot{y} &= 16\beta(\beta - 30)(14(\beta - 30)\beta x + 5y + 84\beta^2x^2) \\ &\quad + 24(17\beta - 6)\beta xy + 6y^2,\end{aligned}\quad (66)$$

has an irreducible algebraic invariant curve of degree 6 given by

$$\begin{aligned}-7y^3 + 3(\beta - 30)^2\beta y^2 + 18(\beta - 30)(-2 + \beta)\beta xy^2 + 27(\beta - 2)^2\beta x^2y^2 \\ + 24(\beta - 30)^3\beta^2xy + 144(\beta - 30)(\beta - 2)^2\beta^2x^3y + 48(\beta - 30)^4\beta^3x^2\end{aligned}$$

$$\begin{aligned}
& + 576(\beta - 30)^2(-2 + \beta)^2\beta^3x^4 - 432(\beta - 2)^2\beta^2(3 + 2\beta)x^4y \\
& - 3456(\beta - 30)(-2 + \beta)^2\beta^3(3 + 2\beta)x^5 \\
& + 3456(\beta - 2)^2\beta^3(12 + \beta)(3 + 2\beta)x^6 \\
& + 24(\beta - 30)^2\beta^2(9\beta - 4)x^2y + 64(\beta - 30)^3\beta^3(9\beta - 4)x^3 = 0. \tag{67}
\end{aligned}$$

For $\beta \in (3/2, 2)$ the curve (67) contains an algebraic limit cycle of degree 6.

PROOF. Let $a = (4 - \beta^2)/7$. When we make the change of coordinates

$$(x, y) = \left(\frac{v + 4u\beta(-30 + 3u(-2 + \beta) + \beta)}{12u^2\beta(\beta^2 - 4)}, \frac{30 - \beta - u(8 + 3\beta)}{14u} \right), \tag{68}$$

multiply by $-21\beta u/2$, and replace (u, v) again with (x, y) , system (58) becomes (66). The curve (67) is obtained from (59) by means of the same change of coordinates and multiplication by $2016\beta^2(\beta^2 - 4)^2u^6$. The irreducibility of (67) is now obvious.

Since the curve (59) contains an algebraic limit cycle for $a \in (0, 1/4)$, the theorem follows in a way similar to the last part of Theorem 7.4. \square

After these results some natural questions are:

OPEN QUESTION 7.6. *Does there exist a chain of rational transformations like the ones above which give examples of quadratic polynomial systems with algebraic limit cycles of arbitrary degree?*

OPEN QUESTION 7.7. *What is the maximum degree of all algebraic limit cycles for quadratic systems?*

8. Limit cycles and algebraic limit cycles

In this section we follow the paper [69]. In 1900 Hilbert [55] in the second part of its 16th problem proposed to find an estimation of the uniform upper bound for the number of limit cycles of all polynomial vector fields of a given degree, and also to study their distribution or configuration in the plane. This has been one of the main problems in the qualitative theory of planar differential equations in the XX century. The contributions of Bamon [5] for the particular case of quadratic vector fields, and mainly of Écalle [39] and Ilyashenko [57] proving that any polynomial vector field has finitely many limit cycles have been the best results in this area. But until now it is not proved the existence of an uniform upper bound. This problem remains open even for the quadratic polynomial vector fields.

A *configuration of limit cycles* is a finite set $C = \{C_1, \dots, C_n\}$ of disjoint simple closed curves of the plane such that $C_i \cap C_j = \emptyset$ for all $i \neq j$.

Given a configuration of limit cycles $C = \{C_1, \dots, C_n\}$ the curve C_i is *primary* if there is no curve C_j of C contained into the bounded region limited by C_i .

Two configurations of limit cycles $C = \{C_1, \dots, C_n\}$ and $C' = \{C'_1, \dots, C'_m\}$ are (topologically) equivalent if there is a homeomorphism $h: \mathbb{R}^2 \rightarrow \mathbb{R}^2$ such that $h(\bigcup_{i=1}^n C_i) = (\bigcup_{i=1}^m C'_i)$. Of course, for equivalent configurations of limit cycles C and C' we have that $n = m$.

We say that the vector field \mathcal{X} realizes the configuration of limit cycles C if the set of all limit cycles of \mathcal{X} is equivalent to C .

THEOREM 8.1. *Let $C = \{C_1, \dots, C_n\}$ be a configuration of limit cycles, and let r be its number of primary curves. Then the following statements hold.*

- (a) *The configuration C is realizable by a polynomial vector field.*
- (b) *The configuration C is realizable as algebraic limit cycles by a polynomial vector field of degree $\leq 2(n + r) - 1$.*

In the proof of Theorem 8.1 we shall provide an explicit expression for the polynomial differential system of degree at most $2(n + r) - 1$ satisfying statement (b) of Theorem 8.1. Of course, statement (a) of Theorem 8.1 follows immediately from statement (b).

The problem of given a configuration of limit cycles realize it by a polynomial differential system has been studied by several authors. Thus, for C^r vector fields the problem has been solved by Al'mukhamedov [1], Balibrea and Jimenez [4] and Valeeva [99]. Statement (a) of Theorem 8.1 has been solved by Schecter and Singer [90] and Sverdllove [98], but they do not provide an explicit polynomial vector field satisfying the given configuration of limit cycles. The result presented in statement (b) of Theorem 8.1 appears in [69], and its proof provides simultaneously the shortest and easiest proof of statement (a) of Theorem 8.1.

We consider C^1 the vector field

$$\mathcal{X} = P \frac{\partial}{\partial x} + Q \frac{\partial}{\partial y}$$

defined in the open subset U of \mathbb{R}^2 . Then, \mathcal{X} is exact in U if

$$\frac{\partial P}{\partial x} = -\frac{\partial Q}{\partial y},$$

for all $(x, y) \in U$. Furthermore, if U is simply connected, then there exists a function $H: U \rightarrow \mathbb{R}$ satisfying

$$P = -\frac{\partial H}{\partial y}, \quad Q = \frac{\partial H}{\partial x}.$$

Therefore, the function H is the *Hamiltonian* of the *Hamiltonian vector field* \mathcal{X} . Clearly, the Hamiltonian function is a first integral of \mathcal{X} .

A C^1 function $R: U \rightarrow \mathbb{R}$ such that

$$\frac{\partial(RP)}{\partial x} = -\frac{\partial(RQ)}{\partial y} \tag{69}$$

is an *integrating factor* of the vector field \mathcal{X} . We know that R is an integrating factor of \mathcal{X} in U if and only if R is a solution of the partial differential equation

$$P \frac{\partial R}{\partial x} + Q \frac{\partial R}{\partial y} = - \left(\frac{\partial P}{\partial x} + \frac{\partial Q}{\partial y} \right) R \tag{70}$$

in U .

A function $V : U \rightarrow \mathbb{R}$ is an *inverse integrating factor* of the vector field \mathcal{X} if V verifies the partial differential equation

$$P \frac{\partial V}{\partial x} + Q \frac{\partial V}{\partial y} = \left(\frac{\partial P}{\partial x} + \frac{\partial Q}{\partial y} \right) V \tag{71}$$

in U . We note that V satisfies (71) in U if and only if $R = 1/V$ satisfies (70) in $U \setminus \{(x, y) \in U : V(x, y) = 0\}$.

The following result due to Giacomini, Llibre and Viano [47] will be essential in our proof of statement (b) of Theorem 8.1. Here, we provide an easier and direct proof.

THEOREM 8.2. *Let X be a C^1 vector field defined in the open subset U of \mathbb{R}^2 . Let $V : U \rightarrow \mathbb{R}$ be an inverse integrating factor of X . If γ is a limit cycle of X , then γ is contained in $\Sigma = \{(x, y) \in U : V(x, y) = 0\}$.*

PROOF. Due to the existence of the inverse integrating factor V defined in U , we have that the vector field X/V is Hamiltonian in $U \setminus \Sigma$. Since the flow of a Hamiltonian vector field preserves the area and in a neighborhood of a limit cycle a flow does not preserve the area, the theorem follows. □

PROOF OF THEOREM 8.1. Let $C = \{C_1, \dots, C_n\}$ be the configuration of limit cycles given in the statement of Theorem 8.1. For every primary curve C_j we select a point p_j in the interior of the bounded component limited by C_j . Since we will work with an equivalent configuration of limit cycles, without loss of generality we can assume that

- (i) each curve C_i is a circle defined by

$$f_i(x, y) = (x - x_i)^2 + (y - y_i)^2 - r_i^2 = 0,$$

for $i = 1, \dots, n$; and that

- (ii) the primary curves of the configuration C are the curves C_j , and the selected points p_j have coordinates (x_j, y_j) , for $j = 1, \dots, r$.

For every selected point p_j we define

$$f_{n+2j-1}(x, y) = (x - x_j) + i(y - y_j),$$

$$f_{n+2j}(x, y) = (x - x_j) - i(y - y_j).$$

Now, we consider the function

$$\tilde{H} = f_1^{\lambda_1} \cdots f_n^{\lambda_n} f_{n+1}^{\lambda_{n+1}} f_{n+2}^{\lambda_{n+2}} \cdots f_{n+2r-1}^{\lambda_{n+2r-1}} f_{n+2r}^{\lambda_{n+2r}} = \prod_{k=1}^{n+2r} f_k,$$

with $\lambda_1 = \cdots = \lambda_n = 1$, and $\lambda_{n+2j-1} = 1 + i$ and $\lambda_{n+2j} = 1 - i$, for $j = 1, \dots, r$. After an easy computation, we have that

$$\tilde{H}(x, y) = A(x, y)B(x, y)C(x, y),$$

where

$$A(x, y) = \prod_{i=1}^n [(x - x_i)^2 + (y - y_i)^2 - r_i^2],$$

$$B(x, y) = \prod_{j=1}^r [(x - x_j)^2 + (y - y_j)^2],$$

$$C(x, y) = \exp\left(-2 \sum_{j=1}^r \arg[(x - x_j) + i(y - y_j)]\right).$$

Clearly $\tilde{H}(x, y)$ is a real function. Therefore, the function

$$H = \log \tilde{H} = \sum_{k=1}^{n+2r} \lambda_k \log f_k$$

is also real.

We claim that the vector field

$$\begin{aligned} \mathcal{X} &= P(x, y) \frac{\partial}{\partial x} + Q(x, y) \frac{\partial}{\partial y} \\ &= - \sum_{k=1}^{n+2r} \lambda_k \left(\prod_{\substack{l=1 \\ l \neq k}}^{n+2r} f_l \right) \frac{\partial f_k}{\partial y} \frac{\partial}{\partial x} + \sum_{k=1}^{n+2r} \lambda_k \left(\prod_{\substack{l=1 \\ l \neq k}}^{n+2r} f_l \right) \frac{\partial f_k}{\partial x} \frac{\partial}{\partial y}, \end{aligned}$$

satisfies the conclusion of statement (b) of Theorem 8.1. Now we shall prove the claim.

First, we note that we have the equalities

$$\frac{\partial H}{\partial x} = \frac{Q}{\prod_{k=1}^{n+2r} f_k}, \quad \frac{\partial H}{\partial y} = - \frac{P}{\prod_{k=1}^{n+2r} f_k}. \quad (72)$$

Therefore, since H and $\prod_{k=1}^{n+2r} f_k$ are real functions, we get that P , Q , and consequently \mathcal{X} are real.

Clearly, from the definition of \mathcal{X} it follows that P and Q are polynomials of degree at most $n + 2r - 1$. So, \mathcal{X} is a real polynomial vector field of degree at most $n + 2r - 1$.

From (72) it follows that $V = \prod_{k=1}^{n+2r} f_k$ is a polynomial inverse integrating factor of \mathcal{X} , and that H is a Hamiltonian for the Hamiltonian vector field

$$\frac{1}{V}X = \frac{P}{V} \frac{\partial}{\partial x} + \frac{Q}{V} \frac{\partial}{\partial y},$$

defined in $\mathbb{R}^2 \setminus \{V = 0\}$.

Since V is polynomial, V is defined in the whole \mathbb{R}^2 . Therefore, by Theorem 8.2 and since $V(x, y) = 0$ if and only if $(x, y) \in (\bigcup_{i=1}^n C_i) \cup \{p_1, \dots, p_r\}$, if the vector field \mathcal{X} has limit cycles, these must be the circles C_i for $i = 1, \dots, n$. Now, we shall prove that all these circles are limit cycles. Hence, the polynomial vector field \mathcal{X} will realize the configuration of limit cycles $\{C_1, \dots, C_n\}$ and the theorem will be proved.

We note that since $\tilde{H} = \exp(H)$ is a first integral of the vector field \mathcal{X} in $\mathbb{R}^2 \setminus \{V = 0\}$, the circles are formed by solutions because they are contained in the level curve $\tilde{V} = 0$, and $V = 0$ is formed by solutions. Now we shall prove that on every circle C_i there is no singular points of \mathcal{X} and, therefore, C_i will be a periodic orbit. Assume that (x_0, y_0) is a singular point of \mathcal{X} contained into the circle C_i ; i.e., $P(x_0, y_0) = Q(x_0, y_0) = f_i(x_0, y_0) = 0$. From the definition of P and Q we have that

$$P(x_0, y_0) = -\lambda_i \left(\prod_{\substack{l=1 \\ l \neq i}}^{n+2r} f_l(x_0, y_0) \right) \frac{\partial f_i}{\partial y}(x_0, y_0) = 0,$$

$$Q(x_0, y_0) = \lambda_i \left(\prod_{\substack{l=1 \\ l \neq i}}^{n+2r} f_l(x_0, y_0) \right) \frac{\partial f_i}{\partial x}(x_0, y_0) = 0.$$

Since $f_l(x_0, y_0) \neq 0$ for $l \neq i$, we obtain that $\frac{\partial f_i}{\partial x}(x_0, y_0) = 0$ and $\frac{\partial f_i}{\partial y}(x_0, y_0) = 0$. Therefore, the point (x_0, y_0) is the center of the circle C_i in contradiction that $f_i(x_0, y_0) = 0$. Hence, every circle C_i is a periodic orbit of the vector field \mathcal{X} . Now, we shall prove that C_i will be a limit cycle, and this will complete the proof of Theorem 8.1.

We note that all circles C_i and all points p_j are in the level $\tilde{H}(x, y) = 0$, and that they are the unique orbits of \mathcal{X} in this level. Now suppose that C_i is not a limit cycle. Then, there is a periodic orbit $\gamma = \{(x(t), y(t)): t \in \mathbb{R}\}$ different from C_1, \dots, C_n and sufficiently close to C_i such that in the bounded component B limited by γ there are the same points of $\{p_1, \dots, p_r\}$ than in the bounded component limited by C_i . Without loss of generality we can assume that these points are p_1, \dots, p_s .

As γ is different from C_1, \dots, C_n , there exists $h \neq 0$ such that

$$\tilde{H}(x(t), y(t)) = A(x(t), y(t))B(x(t), y(t)) \exp\left(-2 \sum_{j=1}^r \theta_j(t)\right) = h, \tag{73}$$

where $\theta_j(t) = \arg[(x(t) - x_j) + i(y(t) - y_j)]$. The function $A(x(t), y(t)) B(x(t), y(t))$ is bounded on γ . Clearly, the angles $\theta_1(t), \dots, \theta_s(t)$ tend all simultaneously (due to its definition) to either $+\infty$ or $-\infty$, when $t \rightarrow +\infty$, while the angles $\theta_{s+1}(t), \dots, \theta_r(t)$ remain bounded when $t \rightarrow +\infty$. These facts are in contradiction with equality (73). Consequently, we have proved that C_i is a limit cycle. In short, Theorem 8.1 is proved. \square

9. Darbouxian theory of integrability and centres

In this section we follow the paper [30]. One of the main applications of the Darbouxian theory of integrability is proving the existence of a centre, see for instance Section 3.

In the elementary theory of qualitative differential equations we identify three main types of behavior at a nondegenerate singular point: a node, a focus, or a saddle. All three are stable, in that a small perturbation will not change the stability of the singular point. Moreover, topologically, we can read off their behavior from just their linear terms. However, there is also the possibility that the singular point is a *fine focus* or a *centre*. That is, the divergence vanishes at that point. In this case the linear terms give a centre: a neighborhood of the origin which consists of closed trajectories. In this case, the nonlinear terms must be examined in order to determine whether the point is stable or unstable. If it is neither and the system is analytic, then the singular point is also a centre for the nonlinear system. Without loss of generality, we can consider the singular point to be at the origin and to be in the form

$$\dot{x} = \lambda x - y + p(x, y), \quad \dot{y} = x + \lambda y + q(x, y), \quad (74)$$

where p and q represent the nonlinear terms. The case of a fine focus or centre corresponds to $\lambda = 0$.

We can distinguish between a centre and a (fine) focus in a number of ways; we follow the most direct first. It can be shown that for any N there is a change of coordinates which brings the origin of (74) to the polar form

$$\begin{aligned} \dot{r} &= c_3 r^3 + c_5 r^5 + \dots + O(r^N), \\ \dot{\theta} &= 1 + d_2 r^2 + d_4 r^4 + \dots + O(r^N). \end{aligned} \quad (75)$$

If all the c_i are zero up to c_{2k+1} , then the system is said to have a *fine focus of order k* . The stability is given by the sign of c_{2k+1} .

It can also be shown that perturbations of the nonlinear terms of (74) can produce in this case at most k limit cycles bifurcating from the origin. Furthermore, if the class of systems (74) are sufficiently general, there are perturbations which produce this number of limit cycles in a multiple Hopf bifurcation. We call c_{2k+1} the *k th Liapunov quantity*.

If all the c_i are zero, then it can be shown that there is an analytic change of coordinates which brings the system into the polar form

$$\dot{r} = 0, \quad \dot{\theta} = 1 + d_2 r^2 + d_4 r^4 + \dots$$

The singular point is obviously a centre in this case.

Given a class of polynomial equations in the form (74), we are often interested in the sub-class with centres at the origin. The problem is that showing that we have a centre requires an infinite number of conditions. However, if we could find an analytic first integral in a neighborhood of the singular point, then the singular point must be a centre. In fact, the linear terms of (74) implies that the first terms of such an integral are $a + b(x^2 + y^2)^s + \dots$, and therefore trajectories close to the origin are closed.

Alternatively, we could find an integrating factor which is well-defined and nonzero in a neighborhood of the singular point. In either case an obvious method for constructing such functions is the Darbouxian theory of integrability. The surprising thing is that this method is so successful.

THEOREM 9.1. *All the nondegenerate centres of systems (74) with homogeneous quadratic or cubic p and q are integrable with Darbouxian first integrals. The same is true if p and q are of the form*

$$p = p_2 + xf, \quad q = q_2 + yf,$$

where p_2, q_2 and f are all homogeneous quadratics.

For a proof of this theorem see [92,89,9].

The last system is the projective version of the quadratic systems and in fact was the system studied by Darboux.

As an example of this, consider the system

$$\begin{aligned} \dot{x} &= y + a_1x^2 + (a_2 + 2b_1)xy - a_1y^2 + x^2y, \\ \dot{y} &= -x + b_1x^2 + (b_2 - 2a_1)xy - b_1y^2 + xy^2, \end{aligned}$$

generically this has 4 invariant lines, whose cofactors are all of the form

$$\alpha x + \beta y + xy.$$

Hence we can conclude that the system has a centre at the origin.

Another method for distinguishing between a focus and a centre is to use a *Liapunov function*. This is a function $V = k + x^2 + y^2 + O((x^2 + y^2)^3/2)$ which satisfies

$$\frac{dV}{dt} = \eta_4(x^2 + y^2)^4 + \eta_6(x^2 + y^2)^6 + \dots + O((x^2 + y^2)^{N/2}). \tag{76}$$

Such a function can always be found in the neighborhood of a fine focus. The origin is a centre if all the η_i vanish. If η_{2k+2} is the first nonzero term, then the origin is a fine focus of order k . Computationally, this method is easier to handle than the normal form (75). The coefficients η_{2i+2} are essentially positive multiples of the c_{2i+1} if we assume that the previous $\eta_{2j+1}, j < i$ vanish.

There is also a third method, closely related to the second. Here we seek a function which is almost an integrating factor. That is we look for a function $R = 1 + O(x, y)$

which satisfies

$$\begin{aligned} \frac{\partial}{\partial x} \left(\frac{P}{R} \right) + \frac{\partial}{\partial y} \left(\frac{Q}{R} \right) \\ = \zeta_2(x^2 + y^2) + \zeta_4(x^2 + y^2)^4 + \dots + O((x^2 + y^2)^{N/2-1}). \end{aligned} \quad (77)$$

Here the origin is a centre if all the ζ_i vanish, and a fine focus of order k if ζ_{2k} is the first nonzero term. The advantage here is that the degrees of the polynomials required here is less than (76). Again the coefficients ζ_{2i} are essentially positive multiples of the c_{2i+1} modulo the previous ζ_{2j} 's.

Now, suppose we are seeking conditions for a centre at the origin. Consider a Darbouxian function B which is composed of invariant algebraic curves which do not pass through the origin and exponential factors. Such a B is well-defined at the origin and

$$\begin{aligned} \frac{d}{dt} B &= B \left[\sum l_i L_i \right], \\ \frac{\partial}{\partial x} \left(\frac{P}{B} \right) + \frac{\partial}{\partial y} \left(\frac{Q}{B} \right) &= \frac{1}{B} \left[\text{div}(P, Q) - \sum l_i L_i \right]. \end{aligned}$$

Since the invariant algebraic curves do not pass through the origin, then the definition of invariant algebraic curve implies that the cofactors L_i must vanish there. We also assume that the divergence is zero at the origin, or there would be no centre. If we have at least $m(m+1)/2 - 1 - q$ invariant algebraic curves and exponential factors, $0 < q \leq (m-1)/2$, then we can choose the l_i nontrivially so that the square brackets of one of the expressions above lies in the vector space generated by the polynomials $(x^2 + y^2)^j$, $j = 1, \dots, q$. Comparing these expressions with (76) and (77), we obtain the following result.

THEOREM 9.2. *Suppose the origin is a fine focus, and that the first q Liapunov quantities at the origin vanish, $0 < q \leq (m-1)/2$. If there are at least $m(m+1)/2 - 1 - q$ invariant algebraic curves or exponential factors not passing through the origin, then there is a local Darbouxian integrating factor. If there are at least $m(m+1)/2 - q$, then there is a Darbouxian first integral. In either case the origin is a centre.*

The result was first noticed by Cozma and Şubă [37,94] using different methods. Another related result is Chavarriga, Giacomini and Giné [18].

10. Non-existence of limit cycles

This section follows the paper [30]. We rename a *Liapunov function* a function $\phi(x, y)$ for which

$$D\phi > 0$$

in the region of interest. Clearly the existence of such a function in a region precludes the existence of periodic solutions and, in particular, limit cycles.

In the same way, we define a *Dulac function* to be a function R such that

$$\frac{\partial}{\partial x} \left(\frac{P}{R} \right) + \frac{\partial}{\partial y} \left(\frac{Q}{R} \right) > 0.$$

By applying the divergence criterion, we can see that such a function also precludes the existence of periodic solutions or limit cycles in any simply connected region where R is well-defined and nonzero.

The analogy between these functions and the first integrals and integrating factors examined up to now is obvious. In particular, given a collection of invariant algebraic curves or exponential factors with cofactors L_i , if we can find constants l_i such that

$$\sum l_i L_i > 0, \quad \text{or} \quad \text{div}(P, Q) - \sum l_i L_i > 0,$$

then there are no limit cycles in any simply connected region where the Darbouxian function is well defined.

For example, the Lotka–Volterra equations are quadratic with two invariant lines. There is also a singular point which does not lie on either line around which any limit cycle must lie. Thus the cofactors of the two lines must vanish at this point. If the divergence also vanishes at the singular point, then we can find a linear dependency between the cofactors and the divergence which means that the system must be integrable and we have a family of closed orbits. If the divergence does not vanish then we can construct a Dulac function or Liapunov function as above. Thus there are no limit cycles in either case.

The example above shows in a simple way how detailed calculations can be reduced to simple geometric arguments instead. We could have replaced the lines above by invariant hyperbolas or parabolas with no increase in difficulty.

If one of the curves was an ellipse, however, we might have problems. First, the ellipse may be a limit cycle in its own right. Second, if the polynomial representing the ellipse appeared to a negative power in the Dulac function, then we cannot apply Green’s theorem since the region surrounding the ellipse is not simply connected. This can be overcome in certain cases by considering line integrals around the loop itself.

In order to get some deeper results, we need to allow some curves which are almost invariant. Rather than abstract things more, we give an example which is very representative of other results.

THEOREM 10.1. *Suppose a quadratic system has an invariant algebraic curve and a singular point not on this curve where the divergence vanishes, then the system has no limit cycles in any simply connected region of the complement of the curve.*

PROOF. Any limit cycle in a quadratic system surrounds only one singular point which must be a focus (see [104]). Suppose a limit cycle surrounds a singular point with nonzero divergence. Let $C = 0$ be the invariant algebraic curve with cofactor L . Thus

$$(PC^r)_x + (QC^r)_y = C^r (rL + \Delta).$$

In this section we denote by Δ the divergence of the system, i.e., $\Delta = P_x + Q_y$. Since both L and Δ must pass through the other singular point, and limit cycles of quadratic system must be convex, we can choose r so that $rL + \Delta$ does not pass through the limit cycle. Hence we have a Dulac function in this case, which contradicts our assumption of a limit cycle.

Suppose now that there is a limit cycle which surrounds the divergence free singular point. Since this point must be a focus we transform the system to the form

$$P = -y + ax^2 + bxy + cy^2, \quad Q = x + dx^2 + exy + fy^2.$$

A further rotation allows us to set $c = 0$ without loss of generality. Consider the function $G = x - 1/b$ for $b \neq 0$ and $G = e^x$ if $b = 0$. We calculate

$$\frac{d}{dt}G = \begin{cases} byG + ax^2, & b \neq 0, \\ -yG + ax^2G, & b = 0. \end{cases}$$

Thus the line $G = 0$ is a transversal, and no limit cycle can cross it. Now, we calculate that

$$(PC^rG^s)_x + (QC^rG^s)_y = \begin{cases} C^rG^{s-1}(G[rL + sbY + \Delta] + sax^2), & b \neq 0, \\ C^rG^{s-1}(G[rL - sy + \Delta] + sGax^2), & b = 0. \end{cases}$$

In either case we can find values of r and s to eliminate the term in square brackets. Once again we have a Dulac function. \square

It seems that algebraic curve methods are the natural ones for proving nonexistence of limit cycles. In Coppel's survey paper [36], for example, all the nonexistence results are obtained this way except one which uses a Liénard system argument. We reprove this here using algebraic curves.

THEOREM 10.2. *A quadratic system (2) with $rP + sQ = \Delta M$ for some polynomial M and real numbers r and s can have no limit cycles. In particular, a quadratic system with two singular points with zero divergence has no limit cycles.*

PROOF. If Δ is a constant we have finished. If $\Delta = a(rx + sy + t)$ for some a and t , then $\Delta = 0$ would be an invariant line. All limit cycles would have to lie in one of the regions $\Delta > 0$ or $\Delta < 0$ which is not possible. Hence the linear terms of Δ must be linearly independent from $rx + sy$ for limit cycles to exist. We can therefore write $M = a\Delta + b(rx + sy) + c$ for some a , b and c .

If $b = 0$, then

$$\frac{d}{dt}(rx + sy) = a\Delta^2 \quad (c = 0),$$

or

$$(e^{-(rx+sy)/c}P)_x + (e^{-(rx+sy)/c}Q)_y = -\frac{a}{c}\Delta^2 e^{-(rx+sy)/c} \quad (c \neq 0).$$

Hence there are no limit cycles. When $b \neq 0$ then

$$\frac{d}{dt} \left(rx + sy + \frac{c}{b} \right) = a\Delta^2 \quad \text{on } rx + sy + \frac{c}{b} = 0,$$

so $rx + sy + c/b = 0$ is a transversal. Furthermore

$$(BP)_x + (BQ)_y = -\frac{a}{b(rx + sy + c/b)} B\Delta^2,$$

where

$$B = \left(rx + sy + \frac{c}{b} \right)^{-1/b},$$

and so we have a Dulac function in this case too. \square

Is it possible to extend these methods to prove the uniqueness of limit cycles if we allow the Dulac function to vanish at the singular point which the limit cycle surrounds? It would be very nice if this was true as many of the uniqueness results for quadratic systems have a nice algebraic content. For example a quadratic system with an invariant line or an invariant parabola have at most one limit cycle. However, no such methods are known at the moment and other less direct methods need to be used.

We finish with a simple example of such a proof. We show that the van der Pol oscillator has a unique limit cycle for small values of the nonlinear terms.

THEOREM 10.3. *The system*

$$\dot{x} = y, \quad \dot{y} = -x - \mu(1 - x^2)y$$

has at most one limit cycle for $|\mu| < \sqrt{3}$.

PROOF. We first let $Y = y + \mu(x - x^3/3)$ to transform the system to the Liénard plane:

$$\dot{x} = Y - \mu(x - x^3/3), \quad \dot{Y} = -x.$$

Now, taking $B = (x^2 - \mu xY + Y^2)^{-1}$, we have

$$(B\dot{x})_x + (B\dot{y})_y = \mu B^2 x^2 (x^2/3 - 2\mu xY/3 + Y^2).$$

For $|\mu| < \sqrt{3}$, B is positive definite and we have a Dulac function defined in the whole of the plane except at the origin. Since each limit cycle must surround the origin, a simple application of Green's theorem shows that there can be at most one limit cycle. \square

11. The inverse problem

In this section we are mainly interested in the polynomial differential systems which have a given set of invariant algebraic curves, independently if they are integrable or not. Thus, first we study the normal forms of planar polynomial vector fields having a given set of generic invariant algebraic curves. That is, in some sense we are interested in a kind of inverse theory of the Darboux theory of integrability. We follow the paper [33]. The main result of this section is the following one.

THEOREM 11.1. *Let $C_i = 0$ for $i = 1, \dots, p$, be irreducible invariant algebraic curves in \mathbb{C}^2 , and set $r = \sum_{i=1}^p \deg C_i$. We assume that all C_i satisfy the following generic conditions:*

- (i) *There are no points at which C_i and its first derivatives are all vanish.*
- (ii) *The highest order terms of C_i have no repeated factors.*
- (iii) *If two curves intersect at a point in the finite plane, they are transversal at this point.*
- (iv) *There are no more than two curves $C_i = 0$ meeting at any point in the finite plane.*
- (v) *There are no two curves having a common factor in the highest order terms.*

Then any polynomial vector field \mathcal{X} of degree m tangent to all $C_i = 0$ satisfies one of the following statements.

- (a) *If $r < m + 1$ then*

$$\mathcal{X} = \left(\prod_{i=1}^p C_i \right) \mathcal{Y} + \sum_{i=1}^p h_i \left(\prod_{\substack{j=1 \\ j \neq i}}^p C_j \right) \mathcal{X}_{C_i}, \quad (78)$$

where $\mathcal{X}_{C_i} = (-C_{iy}, C_{ix})$ is a Hamiltonian vector field, the h_i are polynomials of degree no more than $m - r + 1$, and the \mathcal{Y} is a polynomial vector field of degree no more than $m - r$.

- (b) *If $r = m + 1$ then*

$$\mathcal{X} = \sum_{i=1}^p \alpha_i \left(\prod_{\substack{j=1 \\ j \neq i}}^p C_j \right) \mathcal{X}_{C_i}, \quad (79)$$

with $\alpha_i \in \mathbb{C}$.

- (c) *If $r > m + 1$ then $\mathcal{X} = 0$.*

This theorem due to Christopher [28] was stated in several papers without proof like [28] and [61], and used in other papers as [9] and [66]. The proof that we present here of Theorem 11.1 essentially circulated as the preprint [29] but was never published. Żołądek in [106] (see also Theorem 3 of [107]) stated a similar result to Theorem 11.1, but as far as we know the paper [106] has not been published. In any case Żołądek's approach to Theorem 11.1 is analytic, while our approach is completely algebraic.

Statement (b) of this theorem has a corollary due to Christopher and Kooij [61] showing that system (79) has the integrating factor $\mathcal{R} = (\prod_{i=1}^p C_i)^{-1}$, and consequently the system is Darbouxian integrable.

The following result shows that the generic conditions of Theorem 11.1 are necessary.

THEOREM 11.2. *If one of the conditions (i)–(v) of Theorem 11.1 is not satisfied, then the statements of Theorem 11.1 do not hold.*

We have mentioned that system (1) satisfying the five assumptions of Theorem 11.1 with $r = m + 1$ is Darbouxian integrable. Now we provide two examples of polynomial systems satisfying all assumptions of Theorem 11.1 with $r = m + 1$ except either (ii) or (iii) and which are not Darbouxian integrable. Until now there are very few proofs of polynomial systems which are not Darbouxian integrable, see for instance Jouanolou [58], Moulin Ollagnier [75–77] and [10], see Section 13.

Consider the following quadratic systems:

$$\begin{aligned}\dot{x} &= y(ax - by + b) + x^2 + y^2 - 1, \\ \dot{y} &= bx(y - 1) + a(y^2 - 1),\end{aligned}\tag{80}$$

which has the invariant circle $C_1 = x^2 + y^2 - 1 = 0$ with cofactor $K_1 = 2(x + ay)$ and the invariant straight line $C_2 = y - 1 = 0$ with cofactor $K_2 = bx + ay + a$. We note that C_1 and C_2 are tangent at the point $(0, 1)$.

THEOREM 11.3. *There are values of the parameters a and b for which system (80) is not Darbouxian integrable.*

As a corollary the following result shows that there are polynomial systems with an invariant algebraic curve whose highest order term have repeated factors such that they are not Darbouxian integrable. Consider the following quadratic system:

$$\begin{aligned}\dot{x} &= (1 - b)(x^2 + 2y - 1) - (ax - b)(y - 1) = P(x, y), \\ \dot{y} &= -(bx + 2ay - a)(y - 1) = Q(x, y),\end{aligned}\tag{81}$$

which has the invariant algebraic curves $C_1 = x^2 + 2y - 1 = 0$ with cofactor $K_1 = 2[(1 - b)x - ay + a]$ and $C_2 = y - 1 = 0$ with cofactor $K_2 = -(bx + 2ay - a)$. We note that the highest order term of C_1 has a repeated factor x .

COROLLARY 11.4. *There exist values of the parameters a and b for which system (81) is not Darbouxian integrable.*

In the rest of the section we shall prove the first of these stated four results, for the proof of the others see [33].

PROOF OF THEOREM 11.1. In the proof of this theorem we will use intensively the Hilbert's Nullstellensatz (see for instance, [46]):

Set $A, B_i \in \mathbb{C}[x, y]$ for $i = 1, \dots, r$. If A vanishes in \mathbb{C}^2 whenever the polynomials B_i vanish simultaneously, then there exist polynomials $M_i \in \mathbb{C}[x, y]$ and a nonnegative integer n such that $A^n = \sum_{i=1}^r M_i B_i$. In particular, if all B_i have no common zero, then there exist polynomial M_i such that $\sum_{i=1}^r M_i B_i = 1$.

In what follows if we have a polynomial A we will denotes its degree by a . If we do not say anything we denote by C^c the homogeneous part of degree c for the polynomial C . We shall need the following result.

LEMMA 11.5. *If C^c has no repeated factors, then $(C_x, C_y) = 1$.*

PROOF. Suppose that $(C_x, C_y) \neq 1$. Then there exists a polynomial A nonconstant such that $A|C_x$ and $A|C_y$. Here $A|C_x$ means that the polynomial A divides the polynomial C_x . Therefore, $A^a|(C^c)_x$ and $A^a|(C^c)_y$. By the Euler theorem for homogeneous polynomials we have that $x(C^c)_x + y(C^c)_y = cC^c$. So $A^a|C^c$. Since $A^a, (C^c)_x, (C^c)_y$ and C^c are homogeneous polynomials of $\mathbb{C}[x, y]$ and A^a divides $(C^c)_x, (C^c)_y$ and C^c , the linear factors of A^a having multiplicity m , must be linear factors of C^c having multiplicity $m + 1$. This last statement follows easily identifying the linear factors of the homogeneous polynomial $C^c(x, y)$ in two variables with the roots of the polynomial $C^c(1, z)$ in the variable z . Hence, A^a is a repeated factor of C^c . It is in contradiction with the assumption. \square

We first consider the case that system (1) has a given invariant algebraic curve.

LEMMA 11.6. *Assume that polynomial system (1) of degree m has an invariant algebraic curve $C = 0$ of degree c , and that C satisfies condition (i) of Theorem 11.1.*

(a) *If $(C_x, C_y) = 1$, then system (1) has the following normal form:*

$$\dot{x} = AC - DC_y, \quad \dot{y} = BC + DC_x, \tag{82}$$

where A, B and D are suitable polynomials.

(b) *If C satisfies condition (ii) of Theorem 11.1, then system (1) has the normal form (82) with $a, b \leq m - c$ and $d \leq m - c + 1$. Moreover, if the highest order term C^c of C does not have the factors x and y , then $a \leq p - c, b \leq q - c$ and $d \leq \min\{p, q\} - c + 1$.*

PROOF. (a) Since there are no points at which C, C_x and C_y vanish simultaneously, from Hilbert's Nullstellensatz we obtain that there exist polynomials E, F and G such that

$$EC_x + FC_y + GC = 1. \tag{83}$$

As C satisfies the definition of invariant algebraic curve, we get from (83) that

$$K = (KE + GP)C_x + (KF + GQ)C_y.$$

Substituting K into the definition of invariant algebraic curve $C = 0$, we get

$$[P - (KE + GP)C]C_x = -[Q - (KF + GQ)C]C_y.$$

Since $(C_x, C_y) = 1$, there exists a polynomial D such that

$$P - (KE + GP)C = -DC_y, \quad Q - (KF + GQ)C = DC_x.$$

This proves that system (1) has the form (82) with $A = KE + GP$ and $Q = KF + GQ$.

(b) From (a) and Lemma 11.5 we get that system (1) has the normal form (82). Without loss of generality we can assume that $p \leq q$.

We first consider the case that C^c has neither factor x nor y . So we have $(C^c, (C^c)_x) = 1$ and $(C^c, (C^c)_y) = 1$, where $(C^c)_x$ denotes the derivative of C^c with respect to x . In (82) we assume that $a > p - c$, otherwise the statement follows. Then $d = a + 1$. Moreover, from the highest order terms of (82) we get $A^a C^c = D^{a+1} C_y^{c-1}$, where C_y^{c-1} denotes the homogeneous part with degree $c - 1$ of C_y . Since $(C^c, C_y^{c-1}) = 1$, there exists a polynomial F such that $A^a = F C_y^{c-1}$, $D^{a+1} = F C^c$. In (82) we replace A by $A - F C_y$ and D by $D - F C$, so the degrees of polynomials under consideration reduce by one. We continue this process and do the same for \dot{y} until we reach a system of the form

$$\dot{x} = AC - DC_y, \quad \dot{y} = BC + EC_x, \tag{84}$$

with $a \leq p - c$, $d \leq p - c + 1$, $b \leq q - c$ and $e \leq q - c + 1$. Since $C = 0$ is an invariant algebraic curve of (84), from the definition of invariant algebraic curve we get

$$C(AC_x + BC_y) + C_x C_y (E - D) = KC.$$

This implies that there exists a polynomial R such that $E - D = RC$, because C with C_x and C_y are coprime.

If $e \geq d$, then $r = e - c$. We write $BC + EC_x = (B + RC_x)C + DC_x$ and denote $B + RC_x$ again by B , then system (84) has the form (82) where A, B and D have the required degrees.

If $e < d$, then $r = d - c$. We write $AC - DC_y = (A + RC_y)C - EC_y$ and denote $A + RC_y$ again by A , then system (84) has the form (82) where A, B and E instead of D have the required degrees. This proves the second part of (b).

Now we prove the first part of (b). We note that even though C^c has no repeated factor, C^c with C_x^{c-1} or C_y^{c-1} may have a common factor in x or y (for example $C^3 = x(x^2 + y^2)$, $C^3 = y(x^2 + y^2)$ or $C^4 = xy(x^2 + y^2)$). In order to avoid this difficulty we rotate system (1) slightly such that C^c has no factors in x and y . Then, applying the above method to the new system we get that the new system has a normal form (82) with the degrees of A, B and D as those of the second part of (b).

We claim that under affine changes system (82) preserves its form and the upper bound of the polynomials, i.e., $a, b \leq m - c$ and $d \leq m - c + 1$. Indeed, using the affine change of variables $u = a_1x + b_1y + c_1$ and $v = a_2x + b_2y + c_2$ with $a_1b_2 - a_2b_1 \neq 0$, system (82) becomes

$$\begin{aligned} \dot{u} &= (a_1A + b_1B)C - (a_1b_2 - a_2b_1)DC_v, \\ \dot{v} &= (a_2A + b_2B)C + (a_1b_2 - a_2b_1)DC_u. \end{aligned}$$

Hence, the claim follows. This completes the proof of (b), and consequently we have the proof of the lemma. \square

LEMMA 11.7. *Assume that $C = 0$ and $D = 0$ are different irreducible invariant algebraic curves of system (1) of degree m , and that they satisfy conditions (i) and (iii) of Theorem 11.1.*

(a) *If $(C_x, C_y) = 1$ and $(D_x, D_y) = 1$, then system (1) has the normal form*

$$\dot{x} = ACD - EC_yD - FCD_y, \quad \dot{y} = BCD + EC_xD + FCD_x. \tag{85}$$

(b) *If C and D satisfy conditions (ii) and (v), then system (1) has the normal form (85) with $a, b \leq m - c - d$ and $e, f \leq m - c - d + 1$.*

PROOF. Since $(C, D) = 1$, the curves C and D have finitely many intersection points. By assumption (i) at each of such points there is at least one nonzero first derivative of both C and D . In a similar way to the proof of the claim inside the proof of Lemma 11.6, we can prove that under an affine change of the variables, system (85) preserves its form and the bound for the degrees of A, B, E and F . So, we rotate system (1) slightly such that all first derivatives of C and D are not equal to zero at the intersection points.

From the Hilbert’s Nullstellensatz, there exist polynomials M_i, N_i and $R_i, i = 1, 2$, such that

$$M_1C + N_1D + R_1D_y = 1, \quad M_2C + N_2D + R_2C_y = 1. \tag{86}$$

By Lemma 11.6 we get that

$$P = A_1C - E_1C_y = G_1D - F_1D_y, \tag{87}$$

for some polynomials A_1, E_1, G_1 and F_1 . Moreover, using the first equation of (86) we have $F_1 = SC + TD + UC_y$ for some polynomials S, T and U . Substituting F_1 into (87) we obtain that

$$(A_1 + SD_y)C + (-G_1 + TD_y)D + (-E_1 + UD_y)C_y = 0. \tag{88}$$

Using the second equation of (86) and (88) to eliminate C_y we get

$$-E_1 + UD_y = VC + WD, \tag{89}$$

for some polynomials V and W . Substituting (89) into (88), we have

$$(A_1 + SD_y + VC_y)C = (G_1 - TD_y - WC_y)D.$$

Since $(C, D) = 1$, there exists a polynomial K such that

$$A_1 + SD_y + VC_y = KD, \quad G_1 - TD_y - WC_y = KC. \tag{90}$$

Substituting E_1 of (89) and A_1 of (90) into (87), then we have

$$P = KCD - SC D_y + WC_y D - UC_y D_y. \quad (91)$$

Similarly, we can prove that there exist some polynomials K' , S' , W' and U' such that

$$Q = K'CD + S'CD_x - W'C_x D + U'C_x D_x. \quad (92)$$

Since C is an invariant algebraic curve of (1), we have that $PC_x + QC_y = K_C C$ for some polynomial K_C . Using (91) and (92) we get

$$\begin{aligned} K_C C &= C[D(KC_x + K'C_y) - SC_x D_y + S'C_y D_x] \\ &\quad + C_x C_y [D(W - W') - U D_y + U' D_x]. \end{aligned}$$

As C , C_x and C_y are coprime, there exists a polynomial Z such that

$$D(W - W') - U D_y + U' D_x = ZC. \quad (93)$$

Substituting the expression $DW - U D_y$ into (91), we get

$$P = KCD - SC D_y + W'C_y D - U'C_y D_x + ZCC_y. \quad (94)$$

Since $D = 0$ is an invariant algebraic curve of system (1), we have $PD_x + QD_y = K_D D$ for some polynomial K_D . Using (92) and (94) we get

$$\begin{aligned} K_D D &= D[C(KD_x + K'D_y) + W'(C_y D_x - C_x D_y)] \\ &\quad + D_x [CD_y(-S + S') + U'(C_x D_y - C_y D_x) + ZCC_y]. \end{aligned}$$

As D and D_x are coprime, there exists a polynomial M such that

$$CD_y(-S + S') + U'(C_x D_y - C_y D_x) + ZCC_y = MD. \quad (95)$$

The curves C and D are transversal implies that C , D and $C_x D_y - C_y D_x$ have no common zeros. From Hilbert's Nullstellensatz, there exist some polynomials M_3 , N_3 and R_3 such that

$$M_3 C + N_3 D + R_3 (C_x D_y - C_y D_x) = 1. \quad (96)$$

Eliminating the term $C_x D_y - C_y D_x$ from (95) and (96), we obtain that $U' = IC + JD$ for some polynomials I and J . Hence, Equation (95) becomes

$$\begin{aligned} C[I(C_x D_y - C_y D_x) + D_y(-S + S') + ZC_y] \\ + D[J(C_x D_y - C_y D_x) - M] = 0. \end{aligned}$$

Since $(C, D) = 1$, there exists a polynomial G such that

$$M = J(C_x D_y - C_y D_x) + GC,$$

$$I(C_x D_y - C_y D_x) + D_y(-S + S') + ZC_y = GD.$$

Substituting $ZC_y - SD_y$ and U' into (94) we obtain that

$$P = (K + G)CD - (IC_x + S')CD_y + (W' - JD_x)DC_y.$$

This means that P can be expressed in the form (91) with $U = 0$.

Working in a similar way, we can express Q in the form (92) with $U' = 0$. Thus, (93) is reduced to $D(W - W') = ZC$. Hence, we have $W = W' + HC$ for some polynomial H . Consequently, $Z = HD$. Therefore, from (95) we obtain that $CD_y(-S + S') = D(M - HCC_y)$. Since $(C, D) = 1$ and $(D, D_y) = 1$, we have $S = S' + LD$ for some polynomial L . Substituting W and S into (91) we obtain that P and Q have the form (85). This proves statement (a).

As in the proof of Lemma 11.6 we can prove that under suitable affine change of variables the form of system (85) and the bound of the degrees of the polynomials A, B, E and F are invariant. So, without loss of generality we can assume that the highest order terms of C and D are neither divisible by x nor y .

By the assumptions, the conditions of statement (a) hold, so we get that system (1) has the form (85). If the bounds of the degrees of A, B, E and F are not satisfied, we have by (85) that

$$A^a C^c D^d - E^e C_y^{c-1} D^d - F^f C^c D_y^{d-1} = 0,$$

$$B^b C^c D^d + E^e C_x^{c-1} D^d + F^f C^c D_x^{d-1} = 0. \tag{97}$$

We remark that if one of the numbers $a + c + d, e + c - 1 + d$ and $f + c + d - 1$ is less than the other two, then its corresponding term in the first equation of (97) is equal to zero. The same remark is applied to the second equation of (97). From the hypotheses it follows that C^c and C_y^{c-1} are coprime, and also D^d and D_y^{d-1} , and C^c and D^d , respectively. Hence, from these last two equations we obtain that there exist polynomials K and L such that $E^e = KC^c, F^f = LD^d$, and

$$A^a = KC_y^{c-1} + LD_y^{d-1}, \quad B^b = -KC_x^{c-1} - LD_x^{d-1}.$$

We rewrite Equation (85) as

$$\dot{x} = (A - KC_y - LD_y)CD - (E - KC)C_y D - (F - LD)CD_y,$$

$$\dot{y} = (B + KC_x + LD_x)CD + (E - KC)C_x D + (F - LD)CD_x.$$

Thus, we reduce the degrees of A, B, E and F in (85) by one. We can continue this process until the bounds are reached. This completes the proof of statement (b). \square

LEMMA 11.8. Let $C_i = 0$ for $i = 1, \dots, p$ be different irreducible invariant algebraic curves of system (1) with $\deg C_i = c_i$. Assume that C_i satisfy conditions (i), (iii) and (iv) of Theorem 11.1. Then

(a) If $(C_{ix}, C_{iy}) = 1$ for $i = 1, \dots, p$, then system (1) has the normal form

$$\dot{x} = \left(B - \sum_{i=1}^p \frac{A_i C_{iy}}{C_i} \right) \prod_{i=1}^p C_i, \quad \dot{y} = \left(D + \sum_{i=1}^p \frac{A_i C_{ix}}{C_i} \right) \prod_{i=1}^p C_i, \tag{98}$$

where B, D and A_i are suitable polynomials.

(b) If C_i satisfy conditions (ii) and (v) of Theorem 11.1, then system (1) has the normal form (98) with $b, d \leq m - \sum_{i=1}^p c_i$ and $a_i \leq m - \sum_{i=1}^p c_i + 1$.

PROOF. We use induction to prove this lemma. By Lemmas 11.6 and 11.7 we assume that for any l with $2 \leq l < p$ we have

$$P = \sum_{i=1}^l \left(B_i - \frac{A_i C_{iy}}{C_i} \right) \prod_{i=1}^l C_i, \quad Q = \sum_{i=1}^l \left(D_i + \frac{A_i C_{ix}}{C_i} \right) \prod_{i=1}^l C_i,$$

where $\sum_{i=1}^l B_i = B$ and $\sum_{i=1}^l D_i = D$. Since $C_{l+1} = 0$ is an invariant algebraic curve, from Lemma 11.6 we get that there exist some polynomials E, G and H such that

$$\begin{aligned} P &= \sum_{i=1}^l \left(B_i - \frac{A_i C_{iy}}{C_i} \right) \prod_{i=1}^l C_i = EC_{l+1} - GC_{l+1,y}, \\ Q &= \sum_{i=1}^l \left(D_i + \frac{A_i C_{ix}}{C_i} \right) \prod_{i=1}^l C_i = HC_{l+1} + GC_{l+1,x}. \end{aligned} \tag{99}$$

Now we consider the curves

$$K_j = \prod_{\substack{i=1 \\ i \neq j}}^l C_i = 0, \quad j = 1, \dots, l.$$

From the assumptions we obtain that there is no points at which all the curves $K_i = 0$ and $C_{l+1} = 0$ intersect. Otherwise, at least three of the curves $C_i = 0$ for $i = 1, \dots, l + 1$ intersect at some point. Hence, there exist polynomials U and V_i for $i = 1, \dots, l$ such that

$$UC_{l+1} + \sum_{i=1}^l V_i K_i = 1. \tag{100}$$

Using this equality, we can rearrange (99) as

$$\begin{aligned} (E - GUC_{l+1,y})C_{l+1} &= \sum_{i=1}^l (B_i C_i - A_i C_{iy} + GV_i C_{l+1,y})K_i, \\ (H + GUC_{l+1,x})C_{l+1} &= \sum_{i=1}^l (D_i C_i + A_i C_{ix} - GV_i C_{l+1,x})K_i. \end{aligned} \quad (101)$$

Using (100) and (101) to eliminate C_{l+1} we obtain that

$$E - GUC_{l+1,y} = \sum_{i=1}^l I_i K_i, \quad H + GUC_{l+1,x} = \sum_{i=1}^l J_i K_i,$$

for some polynomials I_i and J_i . Substituting these last equalities into (101), we have

$$\begin{aligned} \sum_{i=1}^l (B_i C_i - A_i C_{iy} + GV_i C_{l+1,y} - I_i C_{l+1})K_i &= 0, \\ \sum_{i=1}^l (D_i C_i + A_i C_{ix} - GV_i C_{l+1,x} - J_i C_{l+1})K_i &= 0. \end{aligned} \quad (102)$$

It is easy to check that the expression multiplying K_i in the two summations of (102) are divisible by C_i . Hence, there exist polynomials L_i and F_i for $i = 1, \dots, l$ such that

$$\begin{aligned} B_i C_i - A_i C_{iy} + GV_i C_{l+1,y} - I_i C_{l+1} &= L_i C_i, \\ D_i C_i + A_i C_{ix} - GV_i C_{l+1,x} - J_i C_{l+1} &= F_i C_i. \end{aligned} \quad (103)$$

So, from (102) we get that $\sum_{i=1}^l L_i = 0$ and $\sum_{i=1}^l F_i = 0$. This implies that (99) can be rewritten as

$$\begin{aligned} P &= \sum_{i=1}^l ((B_i - L_i)C_i - A_i C_{iy})K_i, \\ Q &= \sum_{i=1}^l ((C_i - F_i)C_i + A_i C_{ix})K_i. \end{aligned} \quad (104)$$

Moreover, we write (103) in the form

$$\begin{aligned} (B_i - L_i)C_i - A_i C_{iy} &= I_i C_{l+1} - GV_i C_{l+1,y} = P_i, \\ (D_i - F_i)C_i + A_i C_{ix} &= J_i C_{l+1} + GV_i C_{l+1,x} = Q_i. \end{aligned} \quad (105)$$

It is easy to see that C_i and C_{l+1} are invariant algebraic curves of the system $\dot{x} = P_i, \dot{y} = Q_i$. So, from statement (a) of Lemma 11.7 we can obtain that

$$P_i = (B_i - L_i)C_i - A_i C_{iy} = X_i C_i C_{l+1} - Y_i C_{iy} C_{l+1} - N_i C_i C_{l+1,y},$$

$$Q_i = (D_i - F_i)C_i + A_i C_{ix} = Z_i C_i C_{l+1} + Y_i C_{ix} C_{l+1} + N_i C_i C_{l+1,x}.$$

Substituting these last two equations into (104), we obtain that system (1) has the form (98) with the $l + 1$ invariant algebraic curves C_1, \dots, C_{l+1} . From induction we have finished the proof of statement (a).

The proof of statement (b) is almost identical with those of Lemma 11.7(b), so we shall omit it here. Hence, this ends the proof of the lemma. □

PROOF OF THEOREM 11.1. From Lemma 11.8 it follows statement (a) of Theorem 11.1. By checking the degrees of polynomials A_i, B and D in statement (b) of Lemma 11.8 we obtain statement (b) of Theorem 11.1.

From statement (a) of Lemma 11.8, we can rearrange system (1) such that it has the form (98). But from statement (b) of Lemma 11.8 we must have $B = 0, D = 0$ and $A_i = 0$. This proves statement (c) of Theorem 11.1. □

12. Elementary and Liouvillian first integrals

We now examine the effectiveness of the Darbouxian theory of integrability, i.e., what sort of integrals does it capture. The surprising result is that in some sense it captures every “closed form solution”. However, we clearly need to make this idea precise before we can explain the known results. Here, we follow the paper [30].

The idea of calculating what sort of functions can arise as the result of evaluating an indefinite integral or solving a differential equation goes back to Liouville. The modern formulation of these ideas is usually done through differential algebra. The advantage over an analytic approach is first that the messy details of branch points etc., is hidden completely, and second that the way is open to apply these methods to symbolic computation.

We assume that the set of functions we are interested in form a field together with a number of *derivations*. We call such an object a *differential field*. The process of adding more functions to a given set of functions is described by a tower of such fields:

$$F_0 \subset F_1 \subset \dots \subset F_n.$$

Of course, we must also specify how the derivations of F_0 are extended to derivations on each F_i .

The fields we are interested in arise by adding exponentials, logarithms or the solutions of algebraic equations based on the previous set of functions. That is we take

$$F_i = F_0(\theta_1, \dots, \theta_i),$$

where one of the following holds:

- (i) $\delta\theta_i = \theta_i\delta g$, for some $g \in F_{i-1}$ and for each derivation δ .
- (ii) $\delta\theta_i = g^{-1}\delta g$, for some $g \in F_{i-1}$ and for each derivation δ .
- (iii) θ_i is algebraic over F_{i-1} . If we have such a tower of fields, F_n is called an *elementary extension* of F_0 .

This is essentially what we mean by a function being expressible in closed form. We call the set of all elements of a differential field which are annihilated by all the derivations of the field the *field of constants*. We shall always assume that the field of constants is algebraically closed.

THEOREM 12.1 (Liouville theorem). *If an element f in a differential field F is the derivative of an element g in an elementary extension field G with the same field of constants, then we must have*

$$f = h_0 + \sum c_i \ln(h_i),$$

where c_i are constants and all the h_i lie in F .

We say that our system (1) has an *elementary first integral* if there is an element u in an elementary extension field of the field of rational functions $\mathbb{C}(x, y)$ with the same field of constants such that $Du = 0$. The derivations on $\mathbb{C}(x, y)$ are of course d/dx and d/dy .

THEOREM 12.2 (Prelle and Singer [87]). *If the system (2) has an elementary first integral, then there is also an elementary first integral of the form*

$$v_0 + \sum c_i \ln(v_i),$$

where the c_i are constants and the v_i are algebraic functions over $\mathbb{C}(x, y)$.

It is known that we cannot strengthen this theorem to make all the v_i rational functions in x and y . By manipulating this formula and taking traces we obtain the following corollary.

COROLLARY 12.3. *In the situation above there is always an integrating factor of the form $R^{1/N}$, with $R \in \mathbb{C}(x, y)$ and N an integer.*

Thus the method of Darboux finds all elementary first integrals. For a direct proof of this corollary, see [20].

Another class of integrals we are interested in are the *Liouvillian* ones. Here we say that an extension F_n is a *Liouvillian extension* of F_0 if there is a tower of differential fields as above which satisfies conditions (i), (iii) or

$$(ii)' \quad \delta_\alpha\theta_i = h_\alpha \text{ for some elements } h_\alpha \in F_{i-1} \text{ such that } \delta_\alpha h_\beta = \delta_\beta h_\alpha.$$

This last condition, mimics the introduction of line integrals into the class of functions. Clearly (ii) is included in (ii)'.

This class of functions represents those functions which are obtainable “by quadratures”. An element u of a Liouvillian extension field of $\mathbb{C}(x, y)$ with the same field of constants is said to be a *Liouvillian first integral*.

THEOREM 12.4 (Singer [95]). *If the system (2) has a Liouvillian first integral, then it has an integrating factor of the form*

$$e^{\int U dx + V dy}, \quad U_y = V_x,$$

where U and V are rational functions.

It can be shown that this last expression can always be integrated to get a Darbouxian function. More specifically,

THEOREM 12.5. *Let U, V be two rational functions with*

$$U_y = V_x,$$

then

$$\int U dx + V dy = w_0 + \sum c_i \ln(w_i),$$

for some constants c_i and w_i rational functions.

Hence we have

COROLLARY 12.6. *If system (1) has a Liouvillian first integral, then there is a Darbouxian integrating factor.*

For a direct proof of this result see Pereira [85].

Thus the method of Darboux finds all Liouvillian solutions. However, there is another surprising result.

THEOREM 12.7 (Singer [95]). *Suppose that a trajectory of (1) can be described by a function in a Liouvillian extension of $\mathbb{C}(x, y)$. Then either this function is a first integral of the system, or the function is a polynomial.*

Thus a system has a Darbouxian integrating factor, or the only trajectories that can be described by closed form solutions or quadratures are the polynomial ones.

What does the general first integral of a system with a Darbouxian integrating factor look like? Generically we can show that the first integral is also Darbouxian [27], but stranger things can happen. A reasonable conjecture which embodies all the cases which we know is that it is a sum of a Darbouxian function and terms of the form

$$\int^{R(x,y)} e^{s(u)} \prod k_i(u)^{l_i} du,$$

where R, s and the k_i are rational functions. Several examples of these have been given by Żołądek [106].

13. Liouvillian first integrals for the planar Lotka–Volterra system

The aim of this section is to present the complete classification of the Liouvillian first integrals for the quadratic Lotka–Volterra systems in \mathbb{C}^2 :

$$\begin{aligned}\dot{x} &= x(ax + by + c), \\ \dot{y} &= y(Ax + By + C).\end{aligned}\tag{106}$$

We say that system (106) has a *Liouvillian first integral* if it has a first integral or an integrating factor given by a Darbouxian function, see for more details Section 12 or Singer [95]. We note that our Darbouxian theory of integrability takes into account the invariant algebraic curves and their multiplicity through the exponential factors, see Section 1.5 or for more details [34]. We emphasize that a complete characterization of Liouvillian integrable polynomial differential systems has been made for very few families of differential systems. We follow the paper [10].

As we shall see, systems (106) can be formulated as the following quadratic homogeneous Lotka–Volterra systems in \mathbb{C}^3 :

$$\begin{aligned}\dot{x} &= x((b - B)y + cz), \\ \dot{y} &= y((A - a)x + Cz), \\ \dot{z} &= -z(ax + By).\end{aligned}\tag{107}$$

Several authors and mainly Moulin Ollagnier [77] have studied the Liouvillian first integrals of the system

$$\begin{aligned}\dot{x} &= x(\omega Cy + z) = x\Phi_x, \\ \dot{y} &= y(x + \omega Az) = y\Phi_y, \\ \dot{z} &= z(\omega Bx + y) = z\Phi_z.\end{aligned}\tag{108}$$

In fact, these homogeneous Lotka–Volterra systems in \mathbb{C}^3 can be thought as the planar projective version of the following planar Lotka–Volterra systems in \mathbb{C}^2 :

$$\begin{aligned}\dot{x} &= x(-\omega Bx + (\omega C - 1)y + 1), \\ \dot{y} &= y((1 - \omega B)x - y + \omega A).\end{aligned}\tag{109}$$

For more details between the affine and the projective version of a planar polynomial vector field, see Section 6, or for instance [77] or [70].

We note that if $c(a - A)B \neq 0$, then system (106) becomes system (109) with the following rescaling of the variables:

$$(x, y, t) \rightarrow \left(\frac{c}{A - a}x, -\frac{c}{B}y, \frac{1}{c}t \right),\tag{110}$$

where

$$\omega A = \frac{C}{c}, \quad \omega B = \frac{a}{a - A}, \quad \omega C = \frac{B - b}{B}. \tag{111}$$

The Darbouxian theory of integrability says that if a planar polynomial differential system of degree $m = 2$ has at least $m(m + 1)/2 = 3$ invariant algebraic curves or exponential factors, then the system has a Liouvillian first integral (see again Section 12 or Singer [95]). This result will play a main role in the classification of all Liouvillian first integrals of systems (106).

We want to show that the Darbouxian theory of integrability is one of the best methods for finding first integrals of polynomial ordinary differential equations. For showing this we choose the 2-dimensional Lotka–Volterra systems (106) as paradigmatic systems for the study of the integrability, and we complete the classification of their Liouvillian first integrals. This model, introduced by Lotka [72] and Volterra [100], appears in ecology where it models two species in competition, and it has been widely used in applied mathematics, in chemistry and in a large variety of problems in physics.

Moulin Ollagnier in [77] classified the irreducible systems (108) (and his results provide almost the classification of the nonirreducible ones) having a Liouvillian first integral. In the paper [10] the authors, first, provide a new tool for studying the existence of Liouvillian first integrals, and second they use this tool for completing the classification of systems (107).

System (107) is called *irreducible* if the 1-form

$$\begin{aligned} \omega &= (\Phi_z - \Phi_y)yz \, dx + (\Phi_x - \Phi_z)zx \, dy + (\Phi_y - \Phi_x)xy \, dz \\ &= -(Ax + By + Cz)yz \, dx + (ax + by + cz)zx \, dy \\ &\quad + ((A - a)x + (B - b)y + (C - c)z)xy \, dz \end{aligned}$$

has no nontrivial common factor in its three components, for more details see [77].

Systems (109) always have two invariant algebraic curves $x = 0$ and $y = 0$. From the Darbouxian theory of integrability (see Theorem 2.1), it is known that if they have another invariant algebraic curve or an exponential factor, then the system has a Liouvillian first integral. We remark that almost all the Liouvillian integrable systems (109) given by Moulin Ollagnier in [77] have a third invariant algebraic curve. For system (107) it is shown in [10] that in seven of the new Liouvillian integrable cases the integrability is due to the existence of an exponential factor.

We associate to a given 3-dimensional Lotka–Volterra system (108) two if $\omega A \omega B \times \omega C = 0$, or five if $\omega A \omega B \omega C \neq 0$, *equivalent* 3-dimensional Lotka–Volterra systems. The first two are obtained doing circular permutation of the variables x, y, z and of the parameters $\omega A, \omega B, \omega C$; i.e.,

$$(x, y, z, \omega A, \omega B, \omega C) \rightarrow (y, z, x, \omega B, \omega C, \omega A);$$

and the remainder three systems are obtained doing the transformation

$$(x, y, z, \omega A, \omega B, \omega C) \rightarrow (\omega Bx, \omega Az, \omega Cy, 1/\omega C, 1/\omega B, 1/\omega A),$$

and the two new transformations obtained from this one doing the above circular permutations. Sometimes the conjugated systems to these previous ones are different, obtaining in all 12 related systems. We say that all these Lotka–Volterra systems are *E equivalent*. All the results of this paper are stated modulo these *E* equivalences. Of course, the analogous *E* equivalences exist for 2-dimensional Lotka–Volterra systems (109).

The main results of [77] and [10] are the following two theorems, respectively.

THEOREM 13.1. *Consider an irreducible system (109). Then the following statements are equivalent.*

- (a) *System (109) has a Liouvillian first integral.*
- (b) *System (109) has an invariant algebraic curve $f = 0$ different from $x = 0$ and $y = 0$.*
- (c) *The triple $[\omega A, \omega B, \omega C]$ of parameters of system (109) falls, up to *E* equivalences, in one of the cases of the following list.*

We introduce the following parameters

$$p = -\omega A - \frac{1}{\omega B}, \quad q = -\omega B - \frac{1}{\omega C}, \quad r = -\omega C - \frac{1}{\omega A}.$$

The numbers p, q and r are related with the Kowalevskaya exponents of system (108), see [52] for more details.

In the first two cases $\omega A, \omega B$ and ωC are related by a unique condition and f has degree 1.

1. $\omega A \omega B \omega C + 1 = 0, f = x - \omega C y + \omega A \omega C.$

2. $\omega B = 1$ where $\omega C = 0$ is possible, $f = y - \omega A.$

Case 2 is formed by three *E* equivalent systems. The other two are: $\omega C = 1$ where $\omega A = 0$ is possible, $f = 1 - \omega B x$; and $\omega A = 1$ where $\omega B = 0$ is possible, $f = x - \omega C y.$

In the next two cases $\omega A, \omega B$ and ωC are related by two conditions and f has degree 2.

3. $p = 1, q = 1$, consequently $\omega A \omega B \omega C = 1$ and $r = 1$; $f = \omega A^2(\omega B x - 1)^2 - 2\omega A(\omega B x + 1)y + y^2.$

4. $\omega A = 2, q = 1$; $f = (x - \omega C y)^2 - 2\omega C^2 y.$

Case 4 is formed by five other *E* equivalent systems, namely:

$$\omega B = 2, r = 1, f = (y - \omega A)^2 - 2\omega A^2 x;$$

$$\omega C = 2, p = 1, f = (1 - \omega B x)^2 - 2\omega B^2 x y;$$

$$\omega C = 1/2, p = 1, f = (B x - 1)^2 - 2y\omega C/\omega A;$$

$$\omega A = 1/2, q = 1, f = (\omega C y - x)^2 - 2x\omega A/\omega B;$$

$$\omega B = 1/2, r = 1, f = (\omega A - y)^2 - 2xy\omega B/\omega C.$$

There is a finite number of isolated triples of complex numbers providing an invariant algebraic curve of system (21) with degree 3, 4 or 6. Here i stands for the square root of -1 and $j = (-1 + i\sqrt{3})/2$ is a third root of 1. Firstly, these cases were found in [53] using the so-called Painlevé analysis, see [52].

5. $[\omega A, \omega B, \omega C] = [(j - 1)/3, j - 1, j]$ or equivalently $[p, q, r] = [1, 2, 2]$, here $(\omega A \omega B \omega C)^3 = -1$; $f = 9x^3 - 27jx^2y + 9(2 + j)x^2 - 27(1 + j)xy^2 + 9(2 + j)xy + 9(1 + j)x - 9y^3 - 9(1 - j)y^2 + 9jy + 1 + 2j.$

6. $[\omega A, \omega B, \omega C] = [(i-2)/5, (i-3)/2, i-1]$ or equivalently $[p, q, r] = [1, 2, 3]$, here $(\omega A \omega B \omega C)^2 = -1$; $f = 625x^4 + 2500(1-i)x^3y + 500(3+i)x^3 - 7500ix^2y^2 + 5000x^2y + 300(4+3i)x^2 - 5000(1+i)xy^3 + 1000(1-3i)xy^2 + 200(9+13i)xy + 40(9+13i)x - 2500y^4 + 2000(-2+i)y^3 + 600(-3+4i)y^2 + 80(-2+11i)y + 4(7+24i)$.
7. $[\omega A, \omega B, \omega C] = [-1+j, (-2+j)/7, (-4+j)/3]$ or equivalently $[p, q, r] = [4, 1, 2]$, here $(\omega A \omega B \omega C)^3 = 1$; $f = 6(-397 - 683j)y^5 + 405(8 + 5j)x^4 + 540(19 + 18j)x^3 + 135(-323 + 37j)y^2 + 45(-360 - 323j)y^4 + 162(3 + j)x^5 + 6(25 - 211j)xy^5 + 45(16 - 39j)x^2y^4 + 135(5 - 3j)x^4y^2 + 162(62 + 149j)x + 54(-286 + 397j)y + 60(17 - 20j)x^3y^3 + 54(4 - j)x^5y + 27x^6 + (-37 - 360j)y^6 + 27(37 + 360j) + 324(-87 + 62j)xy + 54(94 + 71j)x^2y + 378(-149 - 87j)xy^2 + 54(179 - 29j)x^3y + 27(-104 - 947j)x^2y^2 + 18(-1427 - 2074j)xy^3 + 162(18 - j)x^4y + 108(52 - 41j)x^3y^2 + 36(73 - 328j)x^2y^3 + 126(-23 - 94j)xy^4 + 60(-683 - 286j)y^3 + 405(39 + 55j)x^2$.

Case 5 is formed by six E equivalent systems which can be obtained doing circular permutations to $[\omega A, \omega B, \omega C]$ and to $[1/\omega C, 1/\omega B, 1/\omega A]$. Cases 6 and 7 are formed by twelve E equivalent systems which are obtained as in Case 5, and additionally conjugating all the parameters.

There are some isolated triples of rational numbers providing an irreducible invariant algebraic curve of degree 3, 4 or 6.

8. $[\omega A, \omega B, \omega C] = [-7/3, 3, -4/7]$, $f = -259308x^3 - 185220x^2y + 259308x^2 + 567xy^3 - 13230xy^2 - 71001xy - 86436x + 324y^4 + 3024y^3 + 10584y^2 + 16464y + 9604$.
9. $[\omega A, \omega B, \omega C] = [-3/2, 2, -4/3]$, $f = 108x^2 + 6xy^2 + 180xy - 108x + 8y^3 + 36y^2 + 54y + 27$.
10. $[\omega A, \omega B, \omega C] = [2, 4, -1/6]$, $f = 216x^3 + 108x^2y - 54x^2 + 18xy^2 - 36xy + y^3 - 4y^2 + 4y$.
11. $[\omega A, \omega B, \omega C] = [2, -8/7, 1/3]$, $f = 216x^3 + 189x^2 + 882xy - 343y^2 + 686y$.
12. $[\omega A, \omega B, \omega C] = [6, 1/2, -2/3]$, $f = 9x^2y + 12xy^2 - 144xy + 432x + 4y^3 - 72y^2 + 432y - 864$.
13. $[\omega A, \omega B, \omega C] = [-6, 1/2, 1/2]$, $f = 3x^2y + 24xy + 144x - 8y^2 - 96y - 288$.
14. $[\omega A, \omega B, \omega C] = [3, 1/5, -5/6]$, $f = 1296x^4 + 4320x^3y - 6480x^3 + 5400x^2y^2 - 18900x^2y + 3000xy^3 - 18000xy^2 + 27000xy + 625y^4 - 5625y^3 + 16875y^2 - 16875y$.
15. $[\omega A, \omega B, \omega C] = [2, -13/7, 1/3]$, $f = 648x^4 - 216x^3y - 252x^2y + 1176xy^2 - 343y^3 + 686y^2$.
16. $[\omega A, \omega B, \omega C] = [2, 2, 2]$, $f = x^2 + xy^2 - 3xy + y$.
17. $[\omega A, \omega B, \omega C] = [2, 3, -3/2]$, $f = 8x^2 + 16xy - y^3 + 4y^2 - 4y$.
18. $[\omega A, \omega B, \omega C] = [2, 2, -5/2]$, $f = 8x^2 - 4xy^2 + 24xy + y^4 - 6y^3 + 12y^2 - 8y$.
19. $[\omega A, \omega B, \omega C] = [-4/3, 3, -5/4]$, $f = 576x^2 + 864xy - 384x + 27y^3 + 108y^2 + 144y + 64$.
20. $[\omega A, \omega B, \omega C] = [-9/4, 4, -5/9]$, $f = 419904x^3 + 279936x^2y - 314928x^2 + 15552xy^2 + 69984xy + 78732x - 256y^4 - 2304y^3 - 7776y^2 - 11664y - 6561$.

21. $[\omega A, \omega B, \omega C] = [-3/2, 2, -7/3]$, $f = 324x^2 + 72xy^2 + 864xy - 324x + 16y^4 + 96y^3 + 216y^2 + 216y + 81$.
22. $[\omega A, \omega B, \omega C] = [-5/2, 2, -8/5]$, $f = 125000x^3 - 5000x^2y^2 + 225000x^2y - 187500x^2 - 1600xy^4 - 6000xy^3 + 15000xy^2 + 87500xy + 93750x - 64y^6 - 960y^5 - 6000y^4 - 20000y^3 - 37500y^2 - 37500y - 15625$.
23. $[\omega A, \omega B, \omega C] = [-10/3, 3, -7/10]$, $f = 81000000x^4 + 64800000x^3y - 108000000x^3 - 243000x^2y^3 + 3240000x^2y^2 + 29700000x^2y + 54000000x^2 - 97200xy^4 - 1296000xy^3 - 6480000xy^2 - 14400000xy - 12000000x + 729y^6 + 14580y^5 + 121500y^4 + 540000y^3 + 1350000y^2 + 1800000y + 1000000$.

There is a special family where the degree of f is unbounded, see Section 4.

24. $[\omega A, \omega B, \omega C] = [-(2l + 1)/(2l - 1), 1/2, 2]$, $l = 1, 2, \dots$. In this case, it is not easy to provide the explicit expression of f .

Cases 8 to 24 are formed by six E equivalent systems, with the exception of Case 16 which is formed by only two E equivalent systems.

From (110) and (111) it follows that systems (106) studied by Moulin Ollagnier are those which satisfy $a(B - b)C \neq 0$ and $c(a - A)B \neq 0$. Therefore, it remains to determine:

- (i) Which are the Liouvillian integrable systems (106) with $a(B - b)C = 0$ and $c(a - A)B \neq 0$?
- (ii) Which are the Liouvillian integrable systems (106) that cannot be written into the form (109)? Or equivalently, what are the Liouvillian integrable systems (106) having $c(a - A)B = 0$?

Now we shall determine the normal forms of the Lotka–Volterra systems (106) which can have a Liouvillian first integral and which have not been studied by Moulin Ollagnier. According with the previous paragraph those systems must be systems (106) satisfying

- (i) either $a(B - b)C = 0$ and $c(a - A)B \neq 0$,
- (ii) or $c(a - A)B = 0$.

In fact, case (ii) can be subdivided into the following two subcases:

- (ii.1) $a(B - b)C \neq 0$ and $c(a - A)B = 0$,
- (ii.2) $a(B - b)C = 0$ and $c(a - A)B = 0$.

Doing the change of variables $(x, y) \rightarrow (y, x)$ it is immediate to check that the expressions $a(B - b)C$ and $c(a - A)B$ are interchanged. Therefore, this change of variables interchanges cases (i) and (ii.1). In other words, case (i) is contained in case (ii). Finally, again due to the change of variables $(x, y) \rightarrow (y, x)$ to study case (ii) is equivalent to study the case $a(B - b)C = 0$.

In the next proposition we reduce the study of systems (106) with $a(B - b)C = 0$ to analyze the Liouvillian integrability of some subclasses of systems (106).

PROPOSITION 13.2. *To complete the study of the Liouvillian integrable Lotka–Volterra systems (106) it is sufficient to consider the Liouvillian integrability of the following subclasses of systems (106):*

$$\begin{aligned}
(\text{lv1}) \quad & \dot{x} = cx, & \dot{y} &= y(Ax + By + C). \\
(\text{lv2}) \quad & \dot{x} = x(y + c), & \dot{y} &= y(By + 1). \\
(\text{lv3}) \quad & \dot{x} = xy, & \dot{y} &= y(x + By + 1). \\
(\text{lv4}) \quad & \dot{x} = xy, & \dot{y} &= y(Ax + By). \\
(\text{lv5}) \quad & \dot{x} = x(ax + by + c), & \dot{y} &= By^2. \\
(\text{lv6}) \quad & \dot{x} = x(y + 1), & \dot{y} &= y(x + By). \\
(\text{lv7}) \quad & \dot{x} = x(ax + by + c), & \dot{y} &= xy. \\
(\text{lv8}) \quad & \dot{x} = x(ax + by), & \dot{y} &= y(x + y). \\
(\text{lv9}) \quad & \dot{x} = x(ax + by + 1), & \dot{y} &= y(x + y). \\
(\text{lv10}) \quad & \dot{x} = x(x + c), & \dot{y} &= y(Ax + 1) \quad \text{with } cA = 0. \\
(\text{lv11}) \quad & \dot{x} = x(x + y + 1), & \dot{y} &= y(Ax + y + 1).
\end{aligned}$$

PROOF. We divide the class of systems (106) satisfying $a(B - b)C = 0$ into the following four subclasses.

Case 1: $a = 0$, $C \neq 0$, $B - b$ arbitrary. Then, doing the rescaling $(x, y, t) \rightarrow (\alpha x, \beta y, t/C)$ in system (106) we obtain the system

$$\dot{x} = x \left(\frac{b\beta}{C} y + \frac{c}{C} \right), \quad \dot{y} = y \left(\frac{A\alpha}{C} x + \frac{B\beta}{C} y + 1 \right). \quad (112)$$

Now we consider the following three subcases:

- (1.1) $b = 0$. Then system (106) is contained into system (lv1) after a redefinition of the parameters.
- (1.2) $b \neq 0$, $A = 0$. Taking $\beta = C/b$ system (112) becomes $\dot{x} = x(y + c/C)$, $\dot{y} = y(By/b + 1)$; i.e., system (lv2) after a redefinition of the parameters.
- (1.3) $bA \neq 0$. Taking $\alpha = C/A$ and $\beta = C/b$ system (112) becomes $\dot{x} = x(y + c/C)$, $\dot{y} = y(x + By/b + 1)$; or equivalently $\dot{x} = x(y + c)$, $\dot{y} = y(x + By + 1)$. Now, if $c \neq 0$, then doing the changes of variables $x = -c/Y$, $y = cX/Y$ and the rescaling of the independent variable $t \rightarrow -Yt/c$, we get system (lv9). If $c = 0$, then we obtain system (lv3).

Case 2: $a = 0$, $C = 0$, $B - b$ arbitrary. Then, doing the rescaling $(x, y, t) \rightarrow (\alpha x, \beta y, \gamma t)$ in system (106) we obtain the system

$$\dot{x} = x(b\beta\gamma y + c\gamma), \quad \dot{y} = y(A\alpha\gamma x + B\beta\gamma y). \quad (113)$$

We deal with the following three subcases:

- (2.1) $b = 0$. We obtain a particular case of system (lv1).
- (2.2) $b \neq 0$, $c = 0$. Taking $\beta = 1/b$ and $\gamma = 1$ in (113) we get system (lv4).
- (2.3) $bc \neq 0$. Taking $\beta = c/b$ and $\gamma = 1/c$ in (113) we get a particular case of system (lv5) if $A = 0$. Additionally, if $A \neq 0$ taking $\alpha = c/A$ we obtain system (lv6).

Case 3: $a \neq 0$, $C = 0$, $B - b$ arbitrary. Then, doing the rescaling $(x, y, t) \rightarrow (\alpha x, \beta y, \gamma t)$ in system (1) we obtain the system

$$\dot{x} = x(\alpha\alpha\gamma x + b\beta\gamma y + c\gamma), \quad \dot{y} = y(A\alpha\gamma x + B\beta\gamma y).$$

We consider four subcases:

(3.1) $A = 0$. Then we obtain system (lv5).

(3.2) $A \neq 0, B = 0$. Taking $\alpha\gamma = 1/A$, we get system (lv7).

(3.3) $AB \neq 0, c = 0$. Taking $\alpha\gamma = 1/A$ and $\beta\gamma = 1/B$, we have system (lv8).

(3.4) $ABC \neq 0$. Taking $\gamma = 1/c, \alpha = c/A$ and $\beta = c/B$, we obtain system (lv9).

Case 4: $a \neq 0, C \neq 0, B - b = 0$. Then, doing the rescaling $(x, y, t) \rightarrow (Cx/a, \beta y, t/C)$ in system (106) we obtain the system

$$\dot{x} = x \left(x + \frac{b\beta}{C}y + \frac{c}{C} \right), \quad \dot{y} = y \left(\frac{A}{a}x + \frac{b\beta}{C}y + 1 \right). \quad (114)$$

We distinguish the two subcases:

(4.1) $b = 0$. Then we obtain system $\dot{x} = x(x + c), \dot{y} = y(Ax + 1)$. If $cA \neq 0$, then doing the change of variables $x = Y, y = X$, and a rescaling of the independent variable this system becomes system (lv2). If $cA = 0$, then we get system (lv10).

(4.2) $b \neq 0$. Taking $\beta = C/b$ system (114) goes over to system $\dot{x} = x(x + y + c), \dot{y} = y(Ax + y + 1)$. If $c \neq 1$ and $A \neq 1$, then doing the change of variables $x = (1 - c)Y/((A - 1)X), y = (1 - c)/X$, and the rescaling of the independent variable $t \rightarrow Xt/(c - 1)$, we obtain system (lv9). If $c \neq 1$ and $A = 1$, then doing the change of variables $x = 1/X, y = Y/X$, and the rescaling of the independent variable $t \rightarrow Xt/(1 - c)$, we obtain system (lv7). If $c = 1$, we get system (lv11). □

In the next proposition we characterize which systems (lvi), for $i = 1, \dots, 11$, are irreducible.

PROPOSITION 13.3. *The following statements hold.*

- (a) *The next systems are irreducible: (lv1) with $c(A^2 + B^2)(B^2 + C^2) \neq 0$, (lv2) with $c(B - 1)(cB - 1) \neq 0$, (lv5) with $(a^2 + c^2)(a^2 + (B - b)^2) \neq 0$, (lv6) with $B \neq 0$, (lv9) with $a \neq 1$ or $b \neq 1$, (lv10) with $c^2 + (A - 1)^2 \neq 0$, and (lv11).*
- (b) *Systems (lv1)–(lv11) which do not appear in (a) are reducible.*

PROOF. The proposition follows easily from the definition of irreducible system. □

From Theorem 2.1 and Propositions 13.2 and 13.3 we obtain the following new Liouvillian integrable Lotka–Volterra systems (106). These new cases are easy to obtain, many of them come from [9]. The difficult problem will be to prove that the Lotka–Volterra systems of Proposition 13.2 which not appear in the following list are not Liouvillian integrable.

25. System (lv1) has the exponential factor $\exp(x)$ if $c \neq 0$; and it has the function x as a first integral if $c = 0$.
26. System (lv2) has the invariant straight line $By + 1 = 0$ if $B \neq 0$, and the exponential factor $\exp(y)$ if $B = 0$.
27. System (lv3) has the integrating factor $1/(x^{B+1}y)$.
28. System (lv4) has the straight line $y = 0$ formed by singular points. So, in $\mathbb{R}^2 \setminus \{y = 0\}$ the system has the first integral of the linear system $\dot{x} = x, \dot{y} = Ax + By$.

29. System (lv5) has the exponential factor $\exp(1/y)$ if $B \neq 0$, and the function y is a first integral if $B = 0$.
30. System (lv6) has the integrating factor $1/(xy)$ if $B = 0$.
31. System (lv7) has the straight line $x = 0$ formed by singular points. So, in $\mathbb{R}^2 \setminus \{x = 0\}$ the system has the first integral of the linear system $\dot{x} = ax + by + c$, $\dot{y} = y$.
32. System (lv8) is a quadratic homogeneous system and consequently it is integrable. In fact, if $a \neq 1$ or $b \neq 1$, then the function $1/(xy((a-1)x + (b-1)y))$ is an integrating factor of the system. If $a = b = 1$ then the straight line $x + y = 0$ is formed by singular points. So, in $\mathbb{R}^2 \setminus \{x + y = 0\}$ the system has the first integral of the linear system $\dot{x} = x$, $\dot{y} = y$.
33. System (lv9) for $b = 0$ has the invariant straight line $ax + 1 = 0$ if $a \neq 0$, and the exponential factor $\exp(x)$ if $a = 0$. If $a = 1$ it has the integrating factor $1/(xy^2)$. If $(a, b) = (1/2, -1)$ then the system has the invariant algebraic curve $xy + 1 + x + x^2/4 = 0$. If $(a, b) = (1/2, 1/2)$ then the system has the exponential factor $\exp((2+x)^2/y)$.
34. System (lv10) has the invariant straight line $x + c = 0$ if $c \neq 0$, and the exponential factor $\exp(1/x)$ if $c = 0$.
35. System (lv11) for $A = 1$ has the straight line $x + y + 1 = 0$ formed by singular points. So, in $\mathbb{R}^2 \setminus \{x + y + 1 = 0\}$ the system has the first integral of the linear system $\dot{x} = x$, $\dot{y} = y$. If $A \neq 1$ it has the exponential factor $\exp(y/x)$.

We note that the exponential factors which appear in cases **33**, **34** and **35** (respectively **29**) correspond to the fact that the geometric multiplicity of the invariant algebraic curve $x = 0$ (respectively $y = 0$) is higher than 1. The exponential factors of the cases **25**, **26** and **33** correspond to the fact that the infinite straight line has geometric multiplicity higher than 1 as invariant algebraic curve of the projectivized vector field. For more details see [34].

In order to show that there are no additional Lotka–Volterra systems to those described in the list which are Liouvillian integrable (modulo the corresponding equivalencies or the reductions to the normal forms of Proposition 13.2), we must prove that the following two systems

$$(lv6) \quad \text{with } B \neq 0.$$

$$(lv9) \quad \text{with } b \neq 0, a \neq 1 \text{ and } (a, b) \notin \{(1/2, -1), (1/2, 1/2)\}$$

have no Liouvillian first integrals. We shall prove this for the system (lv6), similarly can be made for the system (lv9), for more details see [10]. Then the classification of the Liouvillian integrable Lotka–Volterra systems is completed by the following result.

THEOREM 13.4. *The following statements hold.*

- (a) *After Theorem 13.1 to complete the study of the Liouvillian integrable Lotka–Volterra systems (106) it is sufficient to consider the Liouvillian integrability of the eleven subclasses (lvi) of systems (106) for $i = 1, \dots, 11$.*
- (b) *System (lvi) for $i = 1, \dots, 11$ has a Liouvillian first integral if and only if it is one of the cases described from cases **25** to **35**.*

Of course, statement (a) is equivalent to Proposition 13.2.

Now in order to show how to prove Theorem 13.4 we shall study system (lv6) with $B \neq 0$. Systems (lv9) with $b \neq 0$, $a \neq 1$ and $(a, b) \notin \{(1/2, -1), (1/2, 1/2)\}$ can be proved using similar arguments, for more details see [10].

PROPOSITION 13.5. *System (lv6) with $B \neq 0$ has no Liouvillian first integrals.*

PROOF. From Singer results (see Section 12) we know that if system (lv6) with $B \neq 0$ (simply (lv6) in what follows) has a Liouvillian first integral, then it has an integrating factor of the form (14) where the $f_i = 0$ are invariant algebraic curves and the F_j are exponential factors. Now we shall prove that the unique irreducible invariant algebraic curves of (lv6) are $x = 0$ and $y = 0$. So from Proposition 1.10, it follows that the unique invariant algebraic curves of (lv6) are $x = 0$ and $y = 0$. Additionally, we shall also prove that (lv6) has no exponential factors. Since $B \neq 0$ a linear combination of the cofactors of $x = 0$ and $y = 0$ cannot be equal to minus the divergence of system (lv6). Then, by Theorem 2.1 it follows that system (lv6) has no integrating factors of the form (14) with $f_1 = x$ and $f_2 = y$.

We start by proving that system (lv6) has no irreducible invariant algebraic curves different from $x = 0$ and $y = 0$. Suppose that $f = 0$ is an irreducible invariant algebraic curve of (lv6) different from $x = 0$ and $y = 0$. Then f satisfies (9), i.e.,

$$x(y+1)\frac{\partial f}{\partial x} + y(x+By)\frac{\partial f}{\partial y} = (k_0 + k_1x + k_2y)f, \quad (115)$$

where $k_0 + k_1x + k_2y$ is the cofactor of $f = 0$.

Since f is a polynomial we can write

$$\begin{aligned} f &= f_0(x) + f_1(x)y + \cdots + f_m(x)y^m \\ &= \omega f_0(y) + \omega f_1(y)x + \cdots + \omega f_n(y)x^n, \end{aligned} \quad (116)$$

with $f_0(x)$, $f_m(x)$, $\omega f_0(y)$ and $\omega f_n(y)$ nonzero. We note that $f(x, y)$ cannot be independent on x or y , otherwise it factorizes and its factors would correspond to invariant straight lines (real or complex) which do not exist.

Taking $y = 0$ in (115) we get the following ordinary differential equation

$$xf'_0(x) = (k_0 + k_1x)f_0(x).$$

Its general solution is $f_0(x) = Dx^{k_0} \exp(k_1x)$, where D is a constant which cannot be zero, otherwise y would be a factor of f in contradiction with the fact that f is irreducible and different from y . Since $f_0(x)$ is a polynomial, we get that $k_1 = 0$ and $k_0 \in \mathbb{Z}^+$, where \mathbb{Z}^+ denotes the nonnegative integers.

Now, taking $x = 0$ in (115) and since $B \neq 0$, we get the following ordinary differential equation

$$By^2\omega f'_0(y) = (k_0 + k_2y)\omega f_0(y).$$

Its general solution is $\omega f_0(y) = E y^{k_2/B} \exp(-k_0/(By))$, where E is a constant which cannot be zero, otherwise x would be a factor of f in contradiction with the fact that f is irreducible and different from x . Since $\omega f_0(y)$ must be a polynomial, we get that $k_0 = 0$, and that $k_2/B \in \mathbb{Z}^+$.

In short, we have $f_0(x) = D$ and $\omega f_0(y) = E y^{k_2/B}$. Hence, if $k_2 \neq 0$ then $f_0(x) = 0$, because $f(0, 0) = 0$. Therefore, y is a factor of f , a contradiction because f is irreducible and different from y . Consequently, we must have that $k_2 = 0$ and $f_0(x) = \omega f_0(y) = D = E$. Since the cofactor of $f = 0$ is zero, it follows that if there is another irreducible algebraic invariant curve $f = 0$ different from $x = 0$ and $y = 0$, then the polynomial f is a first integral of system (lv6).

Suppose that f is an irreducible polynomial first integral of system (lv6) of minimum degree. Then $H = f - f(0, 0)$ is another polynomial first integral such that $H(0, 0) = 0$ and consequently, $H = x^l y^k g$ with l and k positive integers, g coprime with x and y , and the polynomial g cannot be constant because it is easy to check that system (lv6) has no first integrals of the form $x^l y^k$. Since $H = 0$ is formed by invariant algebraic curves, it follows that $g = 0$ is formed by invariant algebraic curves different from $x = 0$ and $y = 0$. Hence, there exists an irreducible invariant algebraic curve $h = 0$ with h dividing to g (eventually h can be equal to g) different from $x = 0$ and $y = 0$, and having degree smaller than the degree of f . Since h also is an irreducible polynomial first integral (because its cofactor is zero) and its degree is smaller than the degree of f , we have a contradiction with the minimality of the degree of f as a polynomial first integral of system (lv6). In short, we have proved that there are no irreducible invariant algebraic curves of system (lv6) different from $x = 0$ and $y = 0$.

Now we shall prove that system (lv6) has no exponential factors. According to Proposition 1.12, if system (lv6) has exponential factors, then they must be of the form

$$\exp(h), \quad \exp(h/x^l), \quad \exp(h/y^k), \quad \exp(h/(x^l y^k)), \tag{117}$$

where h is a polynomial, and l and k are positive integers.

The singular points of system (lv6) are $(0, 0)$ and $(B, -1)$. Let $k_0 + k_1 x + k_2 y$ be a cofactor of an exponential factor of system (lv6). From the definition of exponential factor, the left-hand side of equality (13) is zero on the singular point $(B, -1)$, then from the right-hand side we obtain that $k_2 = k_0 + Bk_1$. So, a cofactor of any exponential factor of system (lv6) can be written as $k_0 + k_1 x + (k_0 + Bk_1)y$.

First we shall see that there are no exponential factors of the form $\exp(h/x^l)$. Without loss of generality we can assume that h and x are coprime, and l is positive.

Suppose that $\exp(h/x^l)$ is an exponential factor of system (lv6). Then it satisfies (13), i.e.,

$$x(y + 1) \frac{x \partial h / \partial x - lh}{x^{l+1}} + y(x + By) \frac{\partial h / \partial y}{x^l} = k_0 + k_1 x + (k_0 + Bk_1)y,$$

where we have simplified the common factor $\exp(h/x^l)$. This last equality can be written as

$$(y+1)\left(x\frac{\partial h}{\partial x} - lh\right) + y(x+By)\frac{\partial h}{\partial y} = (k_0 + k_1x + (k_0 + Bk_1)y)x^l. \quad (118)$$

Since h is a polynomial we can write

$$h = \omega h_0(y) + \omega h_1(y)x + \omega h_2(y)x^2 + \dots. \quad (119)$$

Taking $x = 0$ in (118) and since $B \neq 0$, we get the following ordinary differential equation

$$-(y+1)l\omega h_0(y) + By^2\omega h_0'(y) = 0.$$

Its general solution is $\omega h_0(y) = Dy^{l/B} \exp(-l/(By))$ where D is a nonzero constant, otherwise x would be a factor of h . The fact that $D \neq 0$ gives a contradiction, because $\omega h_0(y)$ must be a polynomial and l is a positive integer. Hence, there are no exponential factors of the form $\exp(h/x^l)$.

We shall prove that there are no exponential factors of the form $\exp(h)$. Suppose that $\exp(h)$ is an exponential factor of system (lv6). Then it satisfies (13), i.e.,

$$x(y+1)\frac{\partial h}{\partial x} + y(x+By)\frac{\partial h}{\partial y} = k_0 + k_1x + (k_0 + Bk_1)y,$$

where we have simplified the common factor $\exp(h)$. Taking $(x, y) = (0, 0)$ in this equality, it follows that $k_0 = 0$. So, we can write it as follows

$$x(y+1)\frac{\partial h}{\partial x} + y(x+By)\frac{\partial h}{\partial y} = k_1(x+By). \quad (120)$$

Now, taking $x = 0$ in (120) we obtain the following ordinary differential equation

$$y\omega h_0'(y) = k_1,$$

here we have used once more that $B \neq 0$. Its general solution is $\omega h_0(y) = E + k_1 \log y$, where E is a nonzero constant. Since $\omega h_0(y)$ is a polynomial, we get that $k_1 = 0$. However k_1 cannot be zero, otherwise h will be a polynomial first integral, in contradiction with the fact that the unique irreducible invariant algebraic curves are $x = 0$ and $y = 0$. Hence, there are no exponential factors of the form $\exp(h)$.

Suppose that $\exp(h/y^k)$ is an exponential factor of system (lv6). Without loss of generality we can assume that h and y are coprime, and k is positive. Then it satisfies (13), i.e.,

$$x(y+1)\frac{\partial h}{\partial x} + (x+By)\left(y\frac{\partial h}{\partial y} - kh\right) = y^k(k_0 + k_1x + (k_0 + Bk_1)y), \quad (121)$$

where we have simplified the common factor $\exp(h/y^k)$ and multiplied by y^k . Since h is a polynomial we can write

$$h = h_0(x) + h_1(x)y + h_2(x)y^2 + \dots \tag{122}$$

Taking $y = 0$ in Equation (121) we get the following ordinary differential equation

$$h'_0(x) - kh_0(x) = 0.$$

Its general solution is $h_0(x) = D \exp(kx)$ where D is a nonzero constant, otherwise y would be a factor of h . The fact that $D \neq 0$ gives a contradiction, because $h_0(x)$ must be a polynomial and k is a positive integer. Hence, there are no exponential factors of the form $\exp(h/y^k)$.

We shall prove now that there are no exponential factors of the form $\exp(h/(x^l y^k))$ with l and k positive integers. Without loss of generality we can assume that h , x and y are coprime. Then this exponential factor must satisfy (13), i.e.,

$$\begin{aligned} (y + 1) \left(x \frac{\partial h}{\partial x} - lh \right) + (x + By) \left(y \frac{\partial h}{\partial y} - kh \right) \\ = x^l y^k (k_0 + k_1 x + (k_0 + Bk_1)y), \end{aligned}$$

where we have simplified the common factor $\exp(h/(x^l y^k))$ and multiplied by $x^l y^k$. Taking $y = 0$ in this equation we get the following ordinary differential equation

$$xh'_0(x) - (l + kx)h_0(x) = 0.$$

Its general solution is $h_0(x) = Dx^l \exp(kx)$ where D is a nonzero constant, otherwise y would be a factor of h . The fact that $D \neq 0$ gives a contradiction, because $h_0(x)$ must be a polynomial and k is a positive integer. Hence, there are no exponential factors of the form $\exp(h/(x^l y^k))$. This completes the proof of the proposition. \square

14. On the integrability of two-dimensional flows

By definition a *planar differential system* is

$$\frac{dx}{dt} = x' = P(x, y), \quad \frac{dy}{dt} = y' = Q(x, y), \tag{123}$$

where P and Q are C^r maps with $r \geq 1$ from an open subset U of \mathbb{R}^2 to \mathbb{R} . We say that U is the *domain of definition* of the differential system (123), and that

$$X = P \frac{\partial}{\partial x} + Q \frac{\partial}{\partial y} \tag{124}$$

is the C^r *vector field* defined on U associated to differential system (123).

A C^k function $H : U \rightarrow \mathbb{R}$ with $k \geq 0$ is a *strong first integral* of the differential system (123) defined in U if H is constant on each solution of this system, and H is non-constant on any open subset of U . Here $k \geq 0$ means that $k = 0, 1, 2, \dots, \infty, \omega$. More precisely, $k = 0$ means that H is continuous, $k = 1, 2, \dots, \infty$ means that H is C^k , $k = \omega$ means that H is analytic. If $k \geq 1$ then the previous definition of integrability implies that the derivative of H following the direction of the vector field X is zero; i.e., if $XH = 0$ on U .

This definition of strong first integral is the usual definition of first integral which appears in the major part of books on differential equations (see for instance [3] and [96]). With this definition the linear differential system

$$x' = x, \quad y' = y, \quad (125)$$

defined on \mathbb{R}^2 has no strong first integrals. This is due to the fact that every strong first integral of system (125) must be a continuous function on \mathbb{R}^2 that must take a constant value on each straight line through the origin, because these straight lines are formed by orbits of the system. Hence it must be constant on the whole \mathbb{R}^2 , consequently there are no strong first integrals for system (125). By using this argument it follows that if system (123) has a strong first integral, then it cannot have nodes, foci, center-foci, singular points having some parabolic or elliptic sectors, limit cycles and separatrix cycles that be the α - or ω -limit set of some orbit of the system (see [96] for definitions). Since we do not like that differential systems so easy as system (125) have no first integrals, we will introduce the notion of weak first integral.

Let Σ be a set of orbits of system (123) such that $U \setminus \Sigma$ is open. We say that a C^k function $H : U \setminus \Sigma \rightarrow \mathbb{R}$ with $k \geq 0$ is a *weak first integral* of the differential system (1.9) defined in U if H is constant on each solution of system (123) contained in $U \setminus \Sigma$, and H is nonconstant on any open subset of $U \setminus \Sigma$. If $k \geq 1$ this definition implies that the derivative of H following the direction of the vector field X is zero on $U \setminus \Sigma$.

We remark that the unique difference between the notions of strong and weak first integral is that a weak first integral does not need to be defined in the whole domain of definition U of the differential system (123). This difference has been noted by many authors. Thus, the first integrals computed by Darboux [38] in 1878 for polynomial differential systems possessing sufficient algebraic solutions are in general weak first integrals. If we study the integrability of the linear differential systems

$$\frac{dx}{dt} = x' = ax + by, \quad \frac{dy}{dt} = y' = cx + dy, \quad (126)$$

with $ad - bc \neq 0$ (nondegenerate), then with the notion of strong first integral only the centers and the saddles are integrable, but with the notion of weak first integral all linear systems (126) are integrable. In particular we show that system (125) has the weak first integral $H : \mathbb{R}^2 \setminus \{0\} \rightarrow \mathbb{R}$ where $H(x, y) = xy/(x^2 + y^2)$.

We claim that the notion of weak first integral is the natural notion of integrability for two-dimensional differential systems instead of the more usual notion of strong first integral. Theorem 14.1 will confirm this claim. In order to present it we need some preliminary definitions and results. In this section we follow the papers [19,63].

For differential system (123) the following three properties are well known, see for more details [96].

- (a) (*Existence and uniqueness of maximal solutions for a differential system*) For all $p \in U$ there exists an open interval I_p of the real line where it is defined the unique maximal solution $\varphi_p: I_p \rightarrow U$ of (123) such that $\varphi_p(0) = p$.
- (b) (*Group property*) If $q = \varphi_p(t)$ and $t \in I_p$, then $I_q = I_p - t = \{r - t: r \in I_p\}$ and $\varphi_q(s) = \varphi_p(t + s)$ for all $s \in I_q$.
- (c) (*Differentiability with respect to initial conditions*) The set $D = \{(t, p): p \in U, t \in I_p\}$ is open in \mathbb{R}^3 and the map $\varphi: D \rightarrow U$ defined by $\varphi(t, p) = \varphi_p(t)$ is C^r .

The map $\varphi: D \rightarrow U$ is a *local flow* of class C^r with $r \geq 1$ on U associated to system (123), which verifies

- (i) $\varphi(0, p) = p$ for all $p \in U$;
- (ii) $\varphi(t, \varphi(s, p)) = \varphi(t + s, p)$ for all $p \in U$, and all s and t such that $s, t + s \in I_p$;
- (iii) $\varphi_p(-t) = \varphi_p^{-1}(t)$ for all $p \in U$ such that $t, -t \in I_p$.

Let φ be a local flow on the two-dimensional manifold M , and let Σ be a subset of M formed by orbits of φ such that $M \setminus \Sigma$ is open. We say that a C^k function $H: M \setminus \Sigma \rightarrow \mathbb{R}$ with $k \geq 0$ is a *weak first integral* of φ if $H \circ \varphi_p$ is constant for each $p \in M \setminus \Sigma$ and H is not constant on any open subset of $M \setminus \Sigma$. Of course, when the local flow is the local flow associated to a C^r differential system (123) with $r \geq 1$, the above definition of weak first integral for system (123) and the definition of weak first integral for its associated local flow coincide.

In this paper we consider C^r local flows with $r \geq 0$ on an arbitrary two-dimensional manifold M (separable metric, but not necessarily compact nor orientable and possibly with boundary). Of course, when $r = 0$ the flow is only continuous. Two such flows, (M, φ) and (M', φ') , are C^k -equivalent with $k \geq 0$ if there is a C^k diffeomorphism of M onto M' which takes orbits of φ onto orbits of φ' preserving sense (but not necessarily the parametrization). Of course, a C^0 diffeomorphism is a homeomorphism.

Let φ be a C^r local flow with $r \geq 0$ on the two-dimensional manifold M . We call (M, φ) C^k -parallel if it is C^k -equivalent to one of the following flows:

- (1) \mathbb{R}^2 with the flow defined by $x' = 1, y' = 0$;
- (2) $\mathbb{R}^2 \setminus \{0\}$ with the flow defined (in polar coordinates) by $r' = 0, \theta' = 1$;
- (3) $\mathbb{R}^2 \setminus \{0\}$ with the flow defined by $r' = r, \theta' = 0$;
- (4) $\mathbb{S}^1 \times \mathbb{S}^1$ with rational flow (e.g., the flow induced by (123) above under the usual covering map; note in particular that all rational flows on the torus are equivalent).

We call these flows as *strip*, *annular*, *spiral*, and *toral*, respectively.

Let $p \in M$. We denote by $\gamma(p)$ the *orbit* of the flow φ on M through p , more precisely $\gamma(p) = \{\varphi_p(t): t \in I_p\}$. The *positive half-orbit* of $p \in M$ is $\gamma^+(p) = \{\varphi_p(t): t \in I_p, t \geq 0\}$. In a similar way it is defined the *negative half-orbit* $\gamma^-(p)$ of $p \in M$.

We define the α -limit and the ω -limit of p as $(\gamma^\pm(p))$ and let

$$\alpha(p) = \text{cl}(\gamma^-(p)) - \gamma^-(p), \quad \omega(p) = \text{cl}(\gamma^+(p)) - \gamma^+(p),$$

respectively. Here, as usual, cl denotes the closure.

Let $\gamma(p)$ be an orbit of the flow φ defined on M . A *parallel neighborhood* of the orbit $\gamma(p)$ is an open neighborhood N of $\gamma(p)$ such that (N, φ) is C^k -equivalent to a parallel flow for some $k \geq 0$.

We say that $\gamma(p)$ is a *separatrix* of φ if $\gamma(p)$ is not contained in a parallel neighborhood N satisfying the following two assumptions:

- (1) for any $q \in N$, $\alpha(q) = \alpha(p)$ and $\omega(q) = \omega(p)$, and
- (2) $\text{cl}(N) \setminus N$ consists of $\alpha(p)$, $\omega(p)$ and exactly two orbits $\gamma(a)$, $\gamma(b)$ of φ , with $\alpha(a) = \alpha(p) = \alpha(b)$ and $\omega(a) = \omega(p) = \omega(b)$.

We denote by Σ the union of all separatrices of φ . Then Σ is a closed invariant subset of M . A component of the complement of Σ in M , with the restricted flow, is called a *canonical region* of φ .

The main result of this section is the following one.

THEOREM 14.1. *Let φ be a C^r flow on a two-dimensional manifold M for some $r \in \{0, 1, \dots, \infty, \omega\}$, and let Σ be the union of all separatrices of φ . Then*

- (1) *Every canonical region of (M, φ) is C^r parallel.*
- (2) *The flow φ restricted to every canonical region has a C^r (respectively C^∞ , C^ω) first integral for $r \in \mathbb{N}$ (respectively $r = \infty, \omega$).*

Statement (1) in the case C^0 parallel was proved by Markus [74] and Neumann [81], the rest of the theorem is proved in [63]. See [19] for a version C^0 of statement (2). Later on, here we will provide a proof of Theorem 14.1 for the C^0 version.

In the next two theorems we use the fact that any analytic vector field on \mathbb{S}^2 has finitely many limit cycles as it was proved by Il'Yashenko [57] and Écalle [39]. The following two results improve Theorem 14.1 for planar polynomial differential systems. For a proof of them see [63].

THEOREM 14.2. *For every planar polynomial system there exist finitely many invariant curves in \mathbb{R}^2 and singular points γ_i , $i = 1, 2, \dots, l$, such that $\mathbb{R}^2 \setminus (\bigcup_{i=1}^l \gamma_i)$ has finitely many connected open sets, and on each of these connected sets the system has an analytic first integral.*

COROLLARY 14.3. *Let $\mathbf{X} = (P, Q)$ be a polynomial vector field in \mathbb{R}^2 such that P and Q are coprime. Then, using the notations of Theorem 14.2, the set $\bigcup_{i=1}^l \gamma_i$ is formed by all the separatrices of \mathbf{X} in \mathbb{R}^2 , and the open components of $\mathbb{R}^2 \setminus (\bigcup_{i=1}^l \gamma_i)$ are the canonical regions of \mathcal{X} .*

Statement (1) of Theorem 14.1 follows directly from the following result.

LEMMA 14.4 (Neumann lemma [81]). *Let φ be a local flow on the two-dimensional manifold M . Then every canonical region of (M, φ) is C^0 -parallel.*

PROOF. Let $(R, \varphi' = \varphi|_R)$ be a canonical region. There are no separatrices in R , so the set consisting of orbits homeomorphic with \mathbb{S}^1 is open, and similarly the set consisting of orbits homeomorphic with \mathbb{R} is open. Hence, R consists entirely of closed orbits or entirely of line orbits.

Also, two orbits of φ' can be separated with disjoint parallel neighborhoods. To prove this we suppose $\gamma(p)$ and $\gamma(q)$ are distinct orbits (closed or not) which cannot be separated. Then, for any parallel neighborhood N_p of p , we have $q \in \text{cl}(N_p)$; i.e.,

$$q \in \bigcap_{N_p} \text{cl}(N_p) = \alpha(p) \cup \gamma(p) \cup \omega(p).$$

But then $q \in \alpha(p)$ (or $q \in \omega(p)$) and this is impossible because $q \in N_q \subset R$ and $\alpha(p) \cup \omega(p) \subset \text{cl}(N_q) \setminus N_q$.

It follows that the quotient space R/φ' , obtained by collapsing orbits of (R, φ') to points, is a (Hausdorff) one-dimensional manifold. Hence the natural projection $\pi : R \rightarrow R/\varphi'$ is a locally trivial fibering of R over \mathbb{R} or \mathbb{S}^1 . Since the flow provides a natural orientation on the fibers, there are only four possibilities, the four classes of parallel flows described above. □

PROOF OF STATEMENT (2) OF THEOREM 14.1 FOR C^0 FLOWS. From Lemma 14.4 it follows that every canonical region R of (M, φ) is C^0 -parallel; i.e., there is a homeomorphism h of R onto M' which takes orbits of φ onto orbits of φ' preserving the sense (but not necessarily the parametrization), and (M', φ') is one of the following flows:

- (1) $M' = \mathbb{R}^2$ with the flow defined by $x' = 1, y' = 0$;
- (2) $M' = \mathbb{R}^2 \setminus \{0\}$ with the flow defined by $r' = 0, \theta' = 1$;
- (3) $M' = \mathbb{R}^2 \setminus \{0\}$ with the flow defined by $r' = r, \theta' = 0$;
- (4) $M' = \mathbb{S}^1 \times \mathbb{S}^1$ with the rational flow.

Clearly $H(x, y) = y = C$ is a first integral for the flows (1) and (4), $H(r, \theta) = r = C$ a first integral for the flow (2), and $H(r, \theta) = \theta = C$ a first integral for the flow (3). Hence, $H \circ h$ is a continuous valued first integral for the flow φ on the canonical region R . □

15. Darbouxian theory of integrability for polynomial vector fields on surfaces

In this section we follow the paper [68]. A polynomial vector field \mathcal{X} in \mathbb{R}^3 is a vector field of the form

$$\mathcal{X} = P(x, y, z) \frac{\partial}{\partial x} + Q(x, y, z) \frac{\partial}{\partial y} + R(x, y, z) \frac{\partial}{\partial z},$$

where P, Q and R are polynomials in the variables x, y and z with real coefficients. In all this section $m = \max\{\deg P, \deg Q, \deg R\}$ will denote the degree of the polynomial vector field \mathcal{X} .

Let $G : \mathbb{R}^3 \rightarrow \mathbb{R}$ be a C^r map with $r \geq 1$. The gradient of G is defined by

$$\nabla G(x, y, z) = \left(\frac{\partial G}{\partial x}, \frac{\partial G}{\partial y}, \frac{\partial G}{\partial z} \right) (x, y, z).$$

If $\nabla G(x, y, z) \neq 0$ for all points $(x, y, z) \in \mathbb{R}^3$, then

$$\Sigma = \{(x, y, z) \in \mathbb{R}^3 : G(x, y, z) = 0\} \tag{127}$$

is called a 2-dimensional *regular surface*. A polynomial vector field \mathcal{X} in \mathbb{R}^3 defines a *polynomial vector field on Σ* if

$$\mathcal{X}(x, y, z) \cdot \nabla G(x, y, z) = 0, \quad (128)$$

for all the points (x, y, z) of the surface Σ ; i.e., for all $(x, y, z) \in \Sigma$ the vector $\mathcal{X}(x, y, z)$ belongs to the tangent plane to Σ at the point (x, y, z) .

In what follows sometimes we will consider real regular surfaces extended to complex ones; that is, being G a real map we consider its natural extension to \mathbb{C}^3 . Thus, we continue denoting by $\Sigma = \{(x, y, z) \in \mathbb{C}^3: G(x, y, z) = 0\}$ the complexification of (127). Always we will work with real regular surfaces (127) such that its complexification also satisfies (128).

Let U be an open subset of \mathbb{R}^3 . A polynomial vector field \mathcal{X} on the regular surface Σ is *integrable* on the open subset $U \cap \Sigma$ if there exists a nonconstant analytic function $H: U \rightarrow \mathbb{R}$, called a *first integral* of \mathcal{X} on $U \cap \Sigma$, which is constant on all solution curves $(x(t), y(t), z(t))$ of the vector field \mathcal{X} on $U \cap \Sigma$; i.e., $H(x(t), y(t), z(t)) = \text{constant}$ for all values of t for which the solution $(x(t), y(t), z(t))$ is defined on $U \cap \Sigma$. Clearly H is a first integral of the polynomial vector field \mathcal{X} on $U \cap \Sigma$ if and only if $XH = 0$ on all points (x, y, z) of $U \cap \Sigma$. We note that the curves $\{H(x, y, z) = \text{constant}\} \cap (U \cap \Sigma)$ are formed by trajectories of \mathcal{X} .

15.1. Invariant algebraic curves and exponential factors

In a similar way as we did for studying the invariant algebraic curves of real planar polynomial vector fields, also for the real polynomial vector fields on real surfaces we will look for complex invariant algebraic curves and we will think both the real polynomial vector field on a surface and the real surface as complex ones.

Let $f \in \mathbb{C}[x, y, z]$, where as it is usual $\mathbb{C}[x, y, z]$ denotes the ring of the polynomials in the variables x, y and z with complex coefficients. The algebraic surface $f = 0$ defines an *invariant algebraic curve* $\{f = 0\} \cap \Sigma$ of the polynomial vector field \mathcal{X} on the regular surface $\Sigma = \{(x, y, z) \in \mathbb{C}^3: G(x, y, z) = 0\}$ if

(i) for some polynomial $K \in \mathbb{C}[x, y, z]$ of degree at most $m - 1$ we have

$$\mathcal{X}f = P \frac{\partial f}{\partial x} + Q \frac{\partial f}{\partial y} + R \frac{\partial f}{\partial z} = Kf, \quad (129)$$

on all the points (x, y, z) of the surface Σ ;

(ii) the intersection of the two surfaces $f = 0$ and Σ is *transversal*; i.e., for all the points $(x, y, z) \in \{f = 0\} \cap \Sigma$ we have that

$$\nabla G(x, y, z) \wedge \nabla f(x, y, z) \neq 0,$$

where \wedge denotes the vectorial product of two vectors of \mathbb{C}^3 .

The polynomial K is called the *cofactor* of the invariant algebraic curve $\{f = 0\} \cap \Sigma$.

Since on the points of the invariant algebraic curve $\{f = 0\} \cap \Sigma$ the gradient ∇f of the surface $f = 0$ is orthogonal to the polynomial vector field $\mathcal{X} = (P, Q, R)$ (see (129)), and the vector field \mathcal{X} is tangent to the surface Σ , it follows that the vector field \mathcal{X} is tangent to the curve $\{f = 0\} \cap \Sigma$. Hence, the curve $\{f = 0\} \cap \Sigma$ is formed by trajectories of the vector field \mathcal{X} . This justifies the name of invariant algebraic curve given to the curve $\{f = 0\} \cap \Sigma$ satisfying (129) for some polynomial K , because it is *invariant* under the flow defined by \mathcal{X} . We note that our definition of invariant algebraic curve $\{f = 0\} \cap \Sigma$ does not need that the regular surface to be algebraic, only needs that the surface $\{f = 0\}$ be algebraic.

Let h and g polynomials of $\mathbb{C}[x, y, z]$. Then the function $F = \exp(g/h)$ is called an *exponential factor* of the polynomial vector field \mathcal{X} on Σ if for some polynomial $K \in \mathbb{C}[x, y, z]$ of degree at most $m - 1$ it satisfies the following equality

$$\mathcal{X}F = KF, \tag{130}$$

on all the points (x, y, z) of Σ . As before we say that K is the *cofactor* of the exponential factor F .

As we will see from the point of view of the integrability of polynomial vector fields on regular surfaces Σ the importance of the exponential factors is double. On one hand, they verify equation (130), and on the other hand, their cofactors are polynomials of degree at most $m - 1$. These two facts will allow that they play the same role that the invariant algebraic curves in the integrability of a polynomial vector field \mathcal{X} on Σ .

The following proposition has essentially the same proof as Proposition 1.12.

PROPOSITION 15.1. *Let $F = \exp(g/h)$ be an exponential factor for the polynomial vector field \mathcal{X} on the regular surface Σ , satisfying that the polynomials g and h are relatively prime, and that the intersection of the surfaces $\{h = 0\}$ with Σ is transversal. If h is non-constant, then $\{h = 0\} \cap \Sigma$ is an invariant algebraic curve of \mathcal{X} on Σ , and g satisfies the equation*

$$\mathcal{X}g = gK_h + hK_F,$$

on the points (x, y, z) of Σ , where K_h and K_F are the cofactors of h and F respectively.

15.2. The surfaces

Now we describe the 2-dimensional regular surfaces on which we will study the Darbouxian theory of integrability for the polynomial vector fields defined on them. These surfaces will be the quadrics and the 2-torus.

It is well known that the quadrics can be classified into seventeen types. There are five types of imaginary quadrics (namely the imaginary ellipsoid, cone, cylinder, two planes that intersect, and two parallel planes). Since in this section we only consider real polynomial vector fields on real surfaces, we omit these previous five imaginary quadrics. From the twelve real quadrics there are three which are formed by planes (namely two planes

that intersect, two parallel planes, and a double plane). Since the study of the Darbouxian theory of integrability of the polynomial vector fields on these surfaces is reduced to the classical study of the Darbouxian theory of integrability of planar polynomial vector fields, we omit these three types of quadrics. In short we only deal with the remainder nine quadrics.

We remark that the reduction of every quadric to each canonical form is made through a linear isomorphism, and that a such isomorphism and its inverse are polynomial diffeomorphisms. Therefore, the study of the Darbouxian theory of integrability of polynomial vector fields on these nine quadrics can be restricted to take for each of these quadrics its canonical form. In what follows we describe the canonical forms for these nine quadrics and their local charts, that we shall need later on. In fact we only present one local chart for each surface, the full atlas would be described in a similar way, but it is not necessary for studying the existence of first integrals.

Parabolic cylinder. Its canonical form is given by $z^2 - x = 0$.

Elliptic or circular paraboloid. Its canonical form is given by $y^2 + z^2 - x = 0$.

Hyperbolic paraboloid. Its canonical form is given by $y^2 - z^2 - x = 0$.

Let $h(x, y)$ be equal to x , $x - y^2$ and $y^2 - x$ for the parabolic cylinder, the circular paraboloid and the hyperbolic paraboloid, respectively. Then for each one of these cases we have that there is an open subset Ω of \mathbb{R}^2 and a diffeomorphism $\lambda : \Omega \rightarrow \Sigma$ defined by

$$\lambda(r, s) = (x, y, z) = (r, s, \sqrt{h(r, s)}),$$

whose inverse is $\lambda^{-1}(x, y, z) = (r, s) = (x, y)$. The entries of the Jacobian matrix $D\lambda(r, s)$ are polynomial functions in the variables r, s and $\sqrt{h(r, s)}$.

Ellipsoid or sphere. Its canonical form is given by

$$x^2 + y^2 + z^2 - 1 = 0.$$

We identify \mathbb{R}^2 as the tangent plane to the 2-dimensional sphere Σ at the point $(0, 0, -1)$. Then we have $\lambda : \mathbb{R}^2 \rightarrow \Sigma \setminus \{(0, 0, 1)\}$ the diffeomorphism given by

$$\begin{aligned} \lambda(r, s) &= (x, y, z) \\ &= \frac{1}{1 + r^2 + s^2} (2r, 2s, r^2 + s^2 - 1). \end{aligned}$$

That is, λ is the inverse map of the stereographic projection $\lambda^{-1} : \Sigma \setminus \{(0, 0, 1)\} \rightarrow \mathbb{R}^2$ defined by

$$\lambda^{-1}(x, y, z) = (r, s) = \left(\frac{x}{1 - z}, \frac{y}{1 - z} \right).$$

The entries of the Jacobian matrix $D\lambda(r, s)$ are rational functions in the variables r and s .

Hyperboloid of two sheets. Its canonical form is given by

$$x^2 + y^2 - z^2 + 1 = 0.$$

Without loss of generality we restrict our attention to the sheet Σ having $z > 0$. Then we have the diffeomorphism $\lambda: \mathbb{R}^2 \rightarrow \Sigma$ defined by

$$\lambda(r, s) = (x, y, z) = (r, s, \sqrt{r^2 + s^2 + 1}),$$

whose inverse is $\lambda^{-1}(x, y, z) = (r, s) = (x, y)$. The entries of the Jacobian matrix $D\lambda(r, s)$ are rational functions in the variables r, s and $\sqrt{r^2 + s^2 + 1}$.

Cone. Its canonical form is given by

$$x^2 + y^2 - z^2 = 0.$$

Since the cone is not a regular surface at the origin, without loss of generality we restrict our attention to the sheet Σ having $z > 0$. Then we have the diffeomorphism $\lambda: \mathbb{R}^2 \rightarrow \Sigma$ defined by

$$\lambda(r, s) = (x, y, z) = (r, s, \sqrt{r^2 + s^2}),$$

whose inverse is $\lambda^{-1}(x, y, z) = (r, s) = (x, y)$. The entries of the Jacobian matrix $D\lambda(r, s)$ are rational functions in the variables r, s and $\sqrt{r^2 + s^2}$.

Hyperbolic cylinder. Its canonical form is given by

$$x^2 - z^2 - 1 = 0.$$

Without loss of generality we restrict our attention to the sheet Σ having $x > 0$. Then we have the diffeomorphism $\lambda: \mathbb{R}^2 \rightarrow \Sigma$ defined by

$$\lambda(r, s) = (x, y, z) = (\sqrt{s^2 + 1}, r, s),$$

whose inverse is $\lambda^{-1}(x, y, z) = (r, s) = (y, z)$. The entries of the Jacobian matrix $D\lambda(r, s)$ are rational functions in the variables r, s and $\sqrt{s^2 + 1}$.

Hyperboloid of one sheet. Its canonical form is given by

$$x^2 + y^2 - z^2 - 1 = 0.$$

Without loss of generality we restrict our attention to the surface Σ having $z > 0$. Then we have the diffeomorphism $\lambda: \{(r, s) \in \mathbb{R}^2: r^2 + s^2 > 1\} \rightarrow \Sigma \cap \{z > 0\}$ defined by

$$\lambda(r, s) = (x, y, z) = (r, s, \sqrt{r^2 + s^2 - 1}),$$

whose inverse is $\lambda^{-1}(x, y, z) = (r, s) = (x, y)$. The entries of the Jacobian matrix $D\lambda(r, s)$ are rational functions in the variables r, s and $\sqrt{r^2 + s^2 - 1}$.

Elliptic or circular cylinder. Its canonical form is given by

$$x^2 + z^2 - 1 = 0.$$

We identify \mathbb{R}^2 with the tangent plane to the cylinder Σ at the generatrix through the point $(0, 0, -1)$. Let l be the generatrix to the cylinder through the point $(0, 0, 1)$. Then we consider the diffeomorphism $\pi : \mathbb{R}^2 \rightarrow \Sigma \setminus l$ defined by

$$\pi(r, s) = (x, y, z) = \left(\frac{4r}{r^2 + 4}, s, \frac{r^2 - 4}{r^2 + 4} \right),$$

with inverse

$$\pi^{-1}(x, y, z) = (r, s) = \left(\frac{2x}{1 - z}, y \right).$$

The entries of the Jacobian matrix $D\pi(r, s)$ are rational functions in the variables r and s .

After the presentation of the nine quadrics for which we shall study the Darbouxian theory of integrability of their polynomial vector fields, we present the 2-torus.

The 2-torus. We choose for the 2-torus $\mathbf{T}^2 = \mathbb{R}^2/\mathbf{Z}^2$ the following canonical form. For $a > 1$ let $\Sigma \approx \mathbf{T}^2$ be the regular surface of \mathbf{R}^3 defined by

$$z^2 + (\sqrt{x^2 + y^2} - a)^2 = 1.$$

The intersection of this torus with the (x, y) -plane is formed by the two circles γ_1 and γ_2 with center at the origin and radius $a - 1$ and $a + 1$, respectively. Let C be the circular cylinder parallel to the z -axis and tangent to the torus Σ at the circle γ_2 . Let $\mu : C \rightarrow \Sigma \setminus \gamma_1$ be the diffeomorphism

$$\mu(u, v, w) = (x, y, z) = \left(\frac{uv}{(a+1)^2} \left[a - 1 + \frac{8}{w^2 + 4} \right]^2, \frac{4w}{w^2 + 4} \right).$$

On each plane P containing the z -axis, the diffeomorphism $\mu|_{C \cap P}$ is the inverse of the stereographic projection at the two points $P \cap \gamma_1$ from $(\Sigma \setminus \gamma_1) \cap P$ onto the two generatrices $C \cap P$. Its inverse μ^{-1} is given by

$$\mu^{-1}(x, y, z) = (u, v, w) = \left(\frac{(a+1)x}{\sqrt{x^2 + y^2}} \frac{(a+1)y}{\sqrt{x^2 + y^2}}, \frac{2z}{1 - a + \sqrt{x^2 + y^2}} \right).$$

Then we have the diffeomorphism $\lambda = \mu \circ \pi : \mathbb{R}^2 \rightarrow \Sigma \setminus (\gamma_1 \cup \mu(l))$. Here π corresponds to the local chart of a circular cylinder parallel to the z -axis, while the π presented previously corresponds to a cylinder parallel to the y -axis. Here, we have that

$$\lambda^{-1}(x, y, z) = (r, s) = \left(\frac{2(a+1)x}{\sqrt{x^2 + y^2} - (a+1)y}, \frac{2z}{1 - a + \sqrt{x^2 + y^2}} \right).$$

The entries of the Jacobian matrix $D\lambda(r, s)$ are rational functions in the variables r and s .

We remark that the nine quadrics that we consider have canonical form of the type $z^2 = h(x, y)$ where h is a polynomial and its square root is not a polynomial. Similarly, the 2-torus that we consider has canonical form $z^2 = h(x, y) = 1 - (\sqrt{x^2 + y^2} - a)^2$.

15.3. Darbouxian theory

Now we will extend the results of the Darbouxian theory of integrability for planar polynomial vector fields (see for instance Theorem 2.1) to polynomial vector fields on a regular surface Σ . Here the regular surface will be one of the nine quadrics described in the previous subsection, or the 2-torus. In order to develop this theory we need some preliminary algebraic results.

Let $\mathbb{R}_m[x, y, z]$ denote the real linear vector space of all polynomials of $\mathbb{R}[x, y, z]$ having degree $\leq m$. Let $\mathbb{R}_m[x, y, z = \alpha(x, y)]$ be the real linear vector space of all the functions obtained from the polynomials of $\mathbb{R}_m[x, y, z]$ substituting z by the function $\alpha(x, y)$. Here $\alpha(x, y)$ is equal to $\sqrt{h(x, y)}$ for the quadrics and for the 2-torus, where $h(x, y)$ is a polynomial such that its square root is not a polynomial if Σ is a quadric, and $h(x, y) = 1 - (\sqrt{x^2 + y^2} - a)^2$ if Σ is the 2-torus.

We define $d(m)$ as $(m + 1)^2$ or $2(m^2 + 1)$ for the quadrics or the 2-torus, respectively.

LEMMA 15.2. *The dimension of the linear vector space $\mathbb{R}_m[x, y, z = \alpha(x, y)]$ is $d(m)$.*

PROOF. We denote by \mathcal{B}_k a basis of the real vector space formed by all polynomials in the variables x and y having degree $\leq k$. It is well known that the cardinal of \mathcal{B}_k is $(k + 1)(k + 2)/2$.

Assume that the function $\alpha(x, y)$ is associated to one of our nine quadrics. Then it is easy to check that $\mathcal{B}_m \cup \alpha\mathcal{B}_{m-1}$ is a basis for the real vector field $\mathbb{R}_m[x, y, z = \alpha(x, y)]$. Since the cardinal of this basis is

$$\frac{(m + 1)(m + 2)}{2} + \frac{m(m + 1)}{2} = (m + 1)^2,$$

it follows the lemma when the surface is a quadric.

Assume that

$$\alpha(x, y) = \sqrt{1 - (\sqrt{x^2 + y^2} - a)^2} = \sqrt{1 - (\beta - a)^2},$$

is the function associated to the 2-torus. Then it is easy to verify that

$$\mathcal{B}_m \cup \alpha\mathcal{B}_{m-1} \cup \beta\mathcal{B}_{m-2} \cup \alpha\beta\mathcal{B}_{m-3},$$

is a basis for the real vector field $\mathbb{R}_m[x, y, z = \alpha(x, y)]$. Since the cardinal of this basis is

$$\frac{(m + 1)(m + 2)}{2} + \frac{m(m + 1)}{2} + \frac{(m - 1)m}{2} + \frac{(m - 2)(m - 1)}{2} = 2(m^2 + 1),$$

it follows the lemma when the surface is the 2-torus. □

The functions of the linear vector space $\mathbb{R}_m[x, y, z = \alpha(x, y)]$ are polynomials in the variables x, y and α when Σ is a quadric, and polynomials in the variables x, y, α, β and

$\alpha\beta$ when Σ is the 2-torus. We note that such polynomials always have degree one when they are thought as polynomials in the variable either α , β or $\alpha\beta$.

Since the dimension of the linear vector space $\mathbb{R}_m[x, y, z = \alpha(x, y)]$ is $d(m)$, this space is linearly isomorphic to $\mathbb{R}^{d(m)}$ by identifying each polynomial with the $d(m)$ -tuple of its coefficients.

Let Σ be a quadric. For $k = 1, \dots, r$ we say that r points $(x_k, y_k, z_k) \in \Sigma$ are *independent* with respect to the linear vector space $\mathbb{R}_{m-1}[x, y, z = \alpha(x, y)] \equiv \mathbb{R}^{d(m)}$ if the intersection of the r hyperplanes

$$\sum_{i+j=0}^{m(m+1)/2} x_k^i y_k^j a_{ij} + \sum_{i+j=0}^{(m-1)m/2} x_k^i y_k^j \alpha(x_k, y_k) b_{ij} = 0$$

(in the variables a_{ij} and b_{ij} of $\mathbb{R}^{d(m)}$), for $l = 1, \dots, r$, defines a linear subspace of dimension $m^2 - r$.

Let Σ be the 2-torus. We say that r points $(x_k, y_k, z_k) \in \Sigma$, for $k = 1, \dots, r$, are *independent* with respect to the linear vector space $\mathbb{R}_{m-1}[x, y, z = \alpha(x, y)] \equiv \mathbb{R}^{d(m)}$ if the intersection of the r hyperplanes

$$\begin{aligned} &\sum_{i+j=0}^{m(m+1)/2} x_k^i y_k^j a_{ij} + \sum_{i+j=0}^{(m-1)m/2} x_k^i y_k^j \alpha(x_k, y_k) b_{ij} + \sum_{i+j=0}^{(m-2)(m-1)/2} x_k^i y_k^j \beta(x_k, y_k) c_{ij} \\ &+ \sum_{i+j=0}^{(m-3)(m-2)/2} x_k^i y_k^j \alpha(x_k, y_k) \beta(x_k, y_k) d_{ij} = 0, \end{aligned}$$

for $l = 1, \dots, r$ (in the variables a_{ij} , b_{ij} , c_{ij} and d_{ij} of $\mathbb{R}^{d(m)}$) defines a linear subspace of dimension $2m^2 - r$.

THEOREM 15.3. *Let Σ be one of the nine quadrics of the previous subsection or the 2-torus. Suppose that the real polynomial vector field \mathcal{X} on the real regular surface Σ of degree m admits p invariant algebraic curves $\{f_i = 0\} \cap \Sigma$ with cofactors K_i for $i = 1, \dots, p$, q exponential factors $F_j = \exp(g_j/h_j)$ with cofactors L_j for $j = 1, \dots, q$, and r independent singular points (x_k, y_k, z_k) of \mathcal{X} in Σ such that $f_i(x_k, y_k, z_k) \neq 0$ for $i = 1, \dots, p$ and for $k = 1, \dots, r$. Of course, every h_j is equal to some f_i except if h_j is constant. The following statements hold.*

- (a) *There exist $\lambda_i, \mu_j \in \mathbb{C}$ not all zero such that $\sum_{i=1}^p \lambda_i K_i + \sum_{j=1}^q \mu_j L_j = 0$ on all the points (x, y, z) of Σ , if and only if the function $f_1^{\lambda_1} \dots f_p^{\lambda_p} F_1^{\mu_1} \dots F_q^{\mu_q}$ substituting $f_i^{\lambda_i}$ by $|f_i|^{\lambda_i}$ if $\lambda_i \in \mathbb{R}$, is a first integral of the vector field \mathcal{X} on Σ .*
- (b) *If $p + q + r = d(m - 1) + 1$, then there exist $\lambda_i, \mu_j \in \mathbb{C}$ not all zero such that $\sum_{i=1}^p \lambda_i K_i + \sum_{j=1}^q \mu_j L_j = 0$ on all the points (x, y, z) of Σ .*
- (c) *The vector field \mathcal{X} on Σ has a rational first integral if and only if $p + q + r \geq d(m - 1) + 2$ and $p + q \geq 3$.*

PROOF. By hypothesis we have p invariant algebraic curves $\{f_i = 0\} \cap \Sigma$ with cofactors K_i , and q exponential factors F_j with cofactors L_j . That is, the polynomials f_i 's satisfy $\mathcal{X}f_i = K_i f_i$, and the F_j 's satisfy $\mathcal{X}F_j = L_j F_j$, on all the points (x, y, z) of the regular surface Σ .

(a) We have $\lambda_i, \mu_j \in \mathbb{C}$ not all zero such that $\sum_{i=1}^p \lambda_i K_i + \sum_{j=1}^q \mu_j L_j = 0$ on all the points (x, y, z) of Σ . On the other hand, we have that

$$\begin{aligned} &\mathcal{X}(f_1^{\lambda_1} \dots f_p^{\lambda_p} F_1^{\mu_1} \dots F_q^{\mu_q}) \\ &= (f_1^{\lambda_1} \dots f_p^{\lambda_p} F_1^{\mu_1} \dots F_q^{\mu_q}) \left(\sum_{i=1}^p \lambda_i \frac{\mathcal{X}f_i}{f_i} + \sum_{j=1}^q \mu_j \frac{\mathcal{X}F_j}{F_j} \right) \\ &= (f_1^{\lambda_1} \dots f_p^{\lambda_p} F_1^{\mu_1} \dots F_q^{\mu_q}) \left(\sum_{i=1}^p \lambda_i K_i + \sum_{j=1}^q \mu_j L_j \right) = 0, \end{aligned}$$

on all the points (x, y, z) of Σ . Hence statement (a) follows.

(b) Since (x_k, y_k, z_k) is a singular point of the vector field $\mathcal{X} = (P, Q, R)$ on Σ , we have that $P(x_k, y_k, z_k) = Q(x_k, y_k, z_k) = R(x_k, y_k, z_k) = 0$. Then, since $\mathcal{X}f_i = P(\partial f_i / \partial x) + Q(\partial f_i / \partial y) + R(\partial f_i / \partial z) = K_i f_i$ on all the points (x, y, z) of Σ , it follows that $K_i(x_k, y_k, z_k) f_i(x_k, y_k, z_k) = 0$. By assumption $f_i(x_k, y_k, z_k) \neq 0$, therefore $K_i(x_k, y_k, z_k) = 0$ for $i = 1, \dots, p$. Again, since $\mathcal{X}F_j = P(\partial F_j / \partial x) + Q(\partial F_j / \partial y) + R(\partial F_j / \partial z) = L_j F_j$ on all the points (x, y, z) of Σ , it follows that $L_j(x_k, y_k, z_k) F_j(x_k, y_k, z_k) = 0$. Since $F_j = \exp(g_j / h_j)$ does not vanish, $L_j(x_k, y_k, z_k) = 0$ for $j = 1, \dots, q$. Consequently, since the r singular points are independent, all the vectors $K_i(x, y, z = \alpha(x, y))$ and $L_j(x, y, z = \alpha(x, y))$ belong to a linear vector subspace S of $\mathbb{C}_{m-1}[x, y, z = \alpha(x, y)]$ of dimension $d(m-1) - r$. We have $p+q$ vectors $K_i(x, y, z = \alpha(x, y))$ and $L_j(x, y, z = \alpha(x, y))$, and since from the assumptions $p+q > d(m-1) - r$, we obtain that these $p+q$ vectors must be linearly dependent on S . So, there are $\lambda_i, \mu_j \in \mathbb{C}$ not all zero such that

$$\sum_{i=1}^p \lambda_i K_i(x, y, z = \alpha(x, y)) + \sum_{j=1}^q \mu_j L_j(x, y, z = \alpha(x, y)) = 0.$$

Hence statement (b) is proved.

(c) Under the assumptions of statement (c) we can apply statement (b) to two subsets of $p+q-1 \geq 2$ functions defining invariant algebraic curves or exponential factors. Therefore, we get two linear dependencies between the corresponding cofactors, which after some linear algebra and relabeling, we can write into the following form

$$\begin{aligned} M_1 + \alpha_3 M_3 + \dots + \alpha_{p+q} M_{p+q} &= 0, \\ M_2 + \beta_3 M_3 + \dots + \beta_{p+q} M_{p+q} &= 0, \end{aligned}$$

where M_l are the cofactors K_i and L_j , and the α_l and β_l are real numbers. Of course, these two equalities must be satisfied only on all the points (x, y, z) of Σ . Then, by statement (a),

it follows that the two functions

$$|G_1||G_3|^{\alpha_3} \cdots |G_{p+q}|^{\alpha_{p+q}},$$

$$|G_2||G_3|^{\beta_3} \cdots |G_{p+q}|^{\beta_{p+q}},$$

are first integrals of the vector field \mathcal{X} on Σ , where for $l = 1, \dots, p + q$ the function G_l is the polynomial defining an invariant algebraic curve or the exponential factor having cofactor M_l . Then, taking logarithms to the above two first integrals, we obtain that

$$H_1 = \log |G_1| + \alpha_3 \log |G_3| + \cdots + \alpha_{p+q} \log |G_{p+q}|,$$

$$H_2 = \log |G_2| + \beta_3 \log |G_3| + \cdots + \beta_{p+q} \log |G_{p+q}|,$$

are first integrals of the vector field \mathcal{X} on Σ .

For each one of the regular surfaces Σ that we consider, we have defined in the previous subsection a local chart $\lambda: \mathbb{R}^2 \rightarrow \Sigma$ given by $\lambda(r, s) = (x, y, z)$. We continue denoting by λ the natural extension of λ from \mathbb{C}^2 to the complexified Σ . We note that when Σ is the circular cylinder the map here denoted by λ was denoted by ϕ in the previous subsection. Now, the vector field \mathcal{X} on Σ induces a vector field $\omega\mathcal{X}$ on \mathbb{C}^2 through $\omega\mathcal{X}^T(r, s) = D\lambda^{-1}(\lambda(r, s))X^T$ associated to $\omega\mathcal{X}$ is denoted by

$$\dot{r} = \omega P(r, s), \quad \dot{s} = \omega Q(r, s). \tag{131}$$

Since $H_i(x, y, z)$ is a first integral of \mathcal{X} on Σ , it follows that $\omega H_i(r, s) = H_i(\lambda(r, s))$ is a first integral of $\omega\mathcal{X}$ on \mathbb{C}^2 (or \mathbb{R}^2 when we restrict on the real domain), for $i = 1, 2$.

Each first integral ωH_i provides an integrating factor $R_i(r, s)$ for system (131) such that

$$\omega P R_i = \frac{\partial \omega H_i}{\partial r}, \quad \omega Q R_i = -\frac{\partial \omega H_i}{\partial s},$$

for $i = 1, 2$. Therefore, we obtain that

$$\frac{R_1}{R_2} = \frac{\frac{\partial \omega H_2}{\partial r}}{\frac{\partial \omega H_1}{\partial r}}. \tag{132}$$

Since the functions G_l are polynomials or exponentials of a quotient of polynomials, from the expression of H_i it follows that the entries of the Jacobian matrix $DH_i(x, y, z)$ are rational functions in the variables x, y and z . From the chain rule we have that

$$D\omega H_i(r, s) = DH_i(\lambda(r, s)) \circ D\lambda(r, s).$$

In the previous subsection we have studied that the functions $\lambda(r, s)$ and $D\lambda(r, s)$ are rational in the variables r, s and, sometimes $\delta(x, y)$, a convenient square root depending on r and s , according with the type of the surface Σ . So the partial derivatives of (132) are rational functions in the variables r, s and perhaps $\delta(r, s)$.

Now using for each surface Σ the expression $(r, s) = \lambda^{-1}(x, y, z)$, we can write the function R_1/R_2 of (132) in the variables (x, y, z) . From Proposition 15.1 it follows that the function $(R_1/R_2)(r, s)$ is a first integral of system (131), and consequently that the function $(R_1/R_2)(x, y, z)$ is a first integral of the vector field \mathcal{X} on Σ . This completes the proof of statement (c). \square

We note that in statement (b) of Theorem 15.3 the number $d(m-1)+1$ is equal to m^2+1 for the nine quadratics and $2m^2-4m+5$ for the torus.

We remark that in Theorem 15.3(c) once we know a rational first integral in the variables x, y, z and $\mu = \sqrt{x^2+y^2}$, it is always possible to construct a rational first integral in the variables x, y and z .

For an extension of the results of Theorem 15.3 to vector fields on a regular algebraic hypersurface of \mathbb{R}^n see [71].

References

- [1] M.I. Al'mukhamedov, *On the construction of a differential equation having given curves as limit cycles*, Izv. Vyss. Uceb. Zaved. Mat. **1** (44) (1963), 3–6 (in Russian).
- [2] R.F.S. Andrade and A. Rauh, *The Lorenz model and the method of Carleman embedding*, Phys. Lett. A **82** (1981), 276–278.
- [3] V. Arnold, *Équations Différentielles Ordinaires*, Éditions Mir, Moscou (1974).
- [4] F. Balibrea and V. Jimenez, *A characterization of the ω -limit sets of planar continuous dynamical systems*, J. Differential Equations **145** (1998), 469–488.
- [5] R. Bamon, *Quadratic vector fields in the plane have a finite number of limit cycles*, Int. Hautes Études Sci. Publ. Math. **64** (1986), 111–142.
- [6] N.N. Bautin, *On the number of limit cycles which appear with the variation of the coefficients from an equilibrium position of focus or center type*, Math. USSR-Sb. **100** (1954), 397–413.
- [7] T.C. Bountis, A. Ramani, B. Grammaticos and B. Dorizzi, *On the complete and partial integrability of non-Hamiltonian systems*, Phys. A **128** (1984), 268–288.
- [8] L. Brenig and A. Goriely, *Quasimonomial transformations and integrability*, Partially Integrable Evolution Equations in Physics (Les Houches, 1989), NATO Adv. Sci. Inst. Ser. C Math. Phys. Sci., Vol. 310, Kluwer Academic, Dordrecht (1990), 571–572.
- [9] L. Cairó, M.R. Feix and J. Llibre, *Integrability and algebraic solutions for planar polynomial differential systems with emphasis on the quadratic systems*, Resenhas de Universidade de Sao Paulo **4** (2000), 127–161.
- [10] L. Cairó, H. Giacomini and J. Llibre, *Liouvillian first integrals for the planar Lotka–Volterra system*, Rend. Circ. Mat. Palermo **52** (2003), 389–418.
- [11] L. Cairó and J. Llibre, *Darbouxian first integrals and invariants for real quadratic systems having an invariant conic*, J. Phys. A **35** (2002), 589–608.
- [12] A. Campillo and M.M. Carnicer, *Proximity inequalities and bounds for the degree of invariant curves by foliations of $\mathbf{P}_{\mathbb{C}}^2$* , Trans. Amer. Math. Soc. **349** (1997), 2211–2228.
- [13] F. Cantrijn and W. Sarlet, *Generalizations of Noether's theorem in classical mechanics*, SIAM Rev. **23** (1981), 467–494.
- [14] T. Carleman, *Application de la théorie des équations intégrales linéaires aux systèmes d'équations différentielles non linéaires*, Acta Math. **59** (1932), 63.
- [15] M.M. Carnicer, *The Poincaré problem in the nondcritical case*, Ann. Math. **140** (1994), 289–294.
- [16] D. Cerveau and A. Lins Neto, *Holomorphic foliations in $CP(2)$ having an invariant algebraic curve*, Ann. Inst. Fourier **41** (1991), 883–903.
- [17] J. Chavarriga, *Integrable systems in the plane with a center type linear part*, Appl. Math. **22** (1994), 285–309.

- [18] J. Chavarriga, H. Giacomini and J. Giné, *An improvement to Darboux integrability theorem for systems having a center*, Appl. Math. Lett. **12** (1999), 85–89.
- [19] J. Chavarriga, H. Giacomini, J. Giné and J. Llibre, *On the integrability of two-dimensional flows*, J. Differential Equations **157** (1999), 163–182.
- [20] J. Chavarriga, H. Giacomini, J. Giné and J. Llibre, *Darboux integrability and the inverse integrating factor*, J. Differential Equations, **194** (2003), 116–139.
- [21] J. Chavarriga, H. Giacomini and J. Llibre, *Uniqueness of algebraic limit cycles for quadratic systems*, J. Math. Anal. Appl. **261** (2001), 85–99.
- [22] J. Chavarriga and J. Llibre, *On the algebraic limit cycles of quadratic systems*, Proceedings of the IV Catalan Days of Applied Mathematics (Tarragona, 1998), Univ. Rovira Virgili, Tarragona (1998), 17–24.
- [23] J. Chavarriga and J. Llibre, *Invariant algebraic curves and rational first integrals for planar polynomial vector fields*, J. Differential Equations **169** (2001), 1–16.
- [24] J. Chavarriga, J. Llibre and J. Moulin Ollagnier, *On a result of Darboux*, J. Comput. Math. **4** (2001), 197–210.
- [25] J. Chavarriga, J. Llibre and J. Sorolla, *Algebraic limit cycles of quadratic systems*, J. Differential Equations, to appear.
- [26] J. Chavarriga, J. Llibre and J. Sotomayor, *Algebraic solutions for polynomial systems with emphasis in the quadratic case*, Exposition. Math. **15** (1997), 161–173.
- [27] C. Christopher, *Polynomial systems with invariant algebraic curves*, Preprint, University of Wales, Aberystwyth (1991).
- [28] C.J. Christopher, *Invariant algebraic curves and conditions for a center*, Proc. Roy. Soc. Edinburgh A **124** (1994), 1209–1229.
- [29] C. Christopher, *Polynomial systems with invariant algebraic curves*, Preprint (1993).
- [30] C. Christopher and J. Llibre, *Algebraic aspects of integrability for polynomial systems*, Qualitative Theor. Planar Differential Equations **1** (1999), 71–95.
- [31] C. Christopher and J. Llibre, *Integrability via invariant algebraic curves for planar polynomial differential systems*, Ann. Differential Equations **16** (2000), 5–19.
- [32] C. Christopher and J. Llibre, *A family of quadratic polynomial differential systems with invariant algebraic curves of arbitrarily high degree without rational first integrals*, Proc. Amer. Math. Soc. **130** (2002), 2025–2030.
- [33] C. Christopher, J. Llibre, C. Pantazi and X. Zhang, *Darboux integrability and invariant algebraic curves for planar polynomial systems*, J. Phys. A **35** (2002), 2457–2476.
- [34] C. Christopher, J. Llibre and J.V. Pereira, *Multiplicity of invariant algebraic curves in polynomial vector fields*, Preprint (2003).
- [35] C. Christopher, J. Llibre and G. Świrszcz, *Invariant algebraic curves of large degree for quadratic systems*, J. Math. Anal. Appl., to appear.
- [36] W.A. Coppel, *Some quadratic systems with at most one limit cycle*, Dynam. Report. **2** (1989), 61–88.
- [37] D. Cozma and A. Şubă, *Partial integrals and the first focal value in the problem of centre*, Nonlinear Differential Equations Appl. **2** (1995), 21–34.
- [38] G. Darboux, *Mémoire sur les équations différentielles algébriques du premier ordre et du premier degré (Mélanges)*, Bull. Sci. Math. 2ème Série **2** (1878), 60–96, 123–144, 151–200.
- [39] J. Écalle, *Introduction aux fonctions analysables et preuve constructive de la conjecture de Dulac*, Hermann (1992).
- [40] R.M. Evdokimenco, *Construction of algebraic paths and the qualitative investigation in the large of the properties of integral curves of a system of differential equations*, Differential Equations **6** (1970), 1349–1358.
- [41] R.M. Evdokimenco, *Behavior of integral curves of a dynamic system*, Differential Equations **9** (1974), 1095–1103.
- [42] R.M. Evdokimenco, *Investigation in the large of a dynamic system with a given integral curve*, Differential Equations **15** (1979), 215–221.
- [43] V.F. Filiptsov, *Algebraic limit cycles*, Differential Equations **9** (1973), 983–986.
- [44] M. Frommer, *Über das Auftreten von Wirbeln und Strudeln (geschlossener und spiralförmiger Integralkurven) in der Umgebung rationaler Unbestimmtheitsstellen*, Math. Ann. **109** (1934), 395–424.

- [45] W. Fulton, *Algebraic Curves*, Mathematics Lecture Note Series, Benjamin–Cummings (1969). Reprinted by Addison–Wesley (1989).
- [46] S.D. Furta, *On non-integrability of general systems of differential equations*, *Z. Angew. Math. Phys.* **47** (1996), 112–131.
- [47] H. Giacomini, J. Llibre and M. Viano, *On the nonexistence, existence and uniqueness of limit cycles*, *Nonlinearity* **9** (1996), 501–516.
- [48] H. Giacomini, J. Llibre and M. Viano, *On the shape of limit cycles that bifurcate from Hamiltonian centers*, *Nonlinear Anal.* **41** (2000), 523–537.
- [49] H. Giacomini, J. Llibre and M. Viano, *On the shape of limit cycles that bifurcate from non-Hamiltonian centers*, *Nonlinear Anal.* **43** (2001), 837–859.
- [50] H. Giacomini, J. Llibre and M. Viano, *Arbitrary order bifurcations for perturbed Hamiltonian planar systems via the reciprocal of an integrating factor*, *Nonlinear Anal.* **48** (2002), 117–136.
- [51] H.J. Giacomini, C.E. Repetto and O.P. Zandron, *Integrals of motion of three-dimensional non-Hamiltonian dynamical systems*, *J. Phys. A* **24** (1991), 4567–4574.
- [52] A. Goriely, *Integrability and Non-Integrability of Dynamical Systems*, Advanced Series in Nonlinear Dynamics, Vol. 19, World Scientific (2001).
- [53] B. Grammaticos, J. Moulin Ollagnier, A. Ramani, J.M. Strelcyn and S. Wojciechowski, *Integrals of quadratic ordinary differential equations in \mathbb{R}^3 : the Lotka–Volterra system*, *Physica A* **163** (1990), 683–722.
- [54] C. Gutierrez and J. Llibre, *Darboux integrability for polynomial vector fields on the 2-dimensional sphere*, *Extracta Math.* **17** (2002), 289–301.
- [55] J. Hietarinta, *Direct methods for the search of the second invariant*, *Phys. Rep.* **147** (1987), 87–154.
- [56] D. Hilbert, *Mathematische Probleme*, Lecture, Second Internat. Congr. Math. (Paris, 1900), *Nachr. Ges. Wiss. Göttingen Math. Phys. Kl.* (1900), 253–297; English transl.: *Bull. Amer. Math. Soc.* **8** (1902), 437–479.
- [57] Yu. Ilyashenko, *Finiteness Theorems for Limit Cycles*, Translations of Math. Monographs, Vol. 94, Amer. Math. Soc. (1991).
- [58] J.P. Jouanolou, *Equations de Pfaff Algébriques*, Lectures Notes in Mathematics, Vol. 708, Springer-Verlag, New York/Berlin (1979).
- [59] W. Kapteyn, *On the midpoints of integral curves of differential equations of the first degree*, *Nederl. Akad. Wetensch. Verslag. Afd. Natuurk. Koninkl. Nederland* (1911), 1446–1457 (in Dutch).
- [60] W. Kapteyn, *New investigations on the midpoints of integrals of differential equations of the first degree*, *Nederl. Akad. Wetensch. Verslag Afd. Natuurk.* **20** (1912), 1354–1365; **21** (1912), 27–33 (in Dutch).
- [61] R. Kooij and C. Christopher, *Algebraic invariant curves and the integrability of polynomial systems*, *Appl. Math. Lett.* **6** (1993), 51–53.
- [62] P.D. Lax, *Integrals of nonlinear equations of evolution and solitary waves*, *Commun. Pure Appl. Math.* **21** (1968), 467–490.
- [63] Weigu Li, J. Llibre, M. Nicolau and X. Zhang, *On the differentiability of first integrals of two-dimensional flows*, *Proc. Amer. Math. Soc.* **130** (2002), 2079–2088.
- [64] Weigu Li, J. Llibre and Xiang Zhang, *Planar analytic vector fields with generalized rational first integrals*, *Bull. Sci. Math.* **125** (2001), 341–361.
- [65] A. Lins Neto, *Some examples for the Poincaré and Painlevé problems*, *Ann. Sci. École Norm. Sup.* **35** (2002), 231–266.
- [66] J. Llibre, J.S. Pérez del Río and J.A. Rodríguez, *Phase portraits of a new class of integrable quadratic vector fields*, *Dynam. Contin. Discrete Impuls. Systems* **7** (2000), 595–616.
- [67] J. Llibre and G. Rodríguez, *Invariant hyperplanes and Darboux integrability for d-dimensional polynomial differential systems*, *Bull. Sci. Math.* **124** (2000), 1–21.
- [68] J. Llibre and G. Rodríguez, *Darboux integrability of polynomial vector fields on 2-dimensional surfaces*, *J. Bifurcation Chaos* **12** (2002), 2821–2833.
- [69] J. Llibre and G. Rodríguez, *Configurations of limit cycles and planar polynomial vector fields*, *J. Differential Equations* **198** (2004), 374–380.
- [70] J. Llibre and D. Schlomiuk, *The geometry of differential quadratic systems with a weak focus of third order*, *Canadian J. Math.*, to appear.

- [71] J. Llibre and X. Zhang, *Darboux integrability of real polynomial vector fields on regular algebraic hypersurfaces*, Rend. Circ. Mat. Palermo, Serie II **LI** (2002), 109–126.
- [72] A.J. Lotka, *Analytical note on certain rhythmic relations in organic systems*, Proc. Nat. Acad. Sci. **6** (1920), 410.
- [73] Yiu-Kwong Man and M.A.H. MacCallum, *A rational approach to the Prelle–Singer algorithm*, J. Symbolic Comput. **24** (1997), 31–43.
- [74] L. Markus, *Global structure of ordinary differential equations in the plane*, Trans. Amer. Math. Soc. **76** (1954), 127–148.
- [75] J. Moulin Ollagnier, *Polynomial first integrals of the Lotka–Volterra system*, Bull. Sci. Math. **121** (1997), 463–476.
- [76] J. Moulin Ollagnier, *Rational integration of the Lotka–Volterra system*, Bull. Sci. Math. **123** (1999), 437–466.
- [77] J. Moulin Ollagnier, *Liouvillian Integration of the Lotka–Volterra system*, Qualitative Theor. Dynamical Systems **2** (2001), 307–358.
- [78] J. Moulin Ollagnier, *About a conjecture on quadratic vector fields*, J. Pure Appl. Algebra **165** (2001), 227–234.
- [79] J. Moulin Ollagnier, A. Nowicki and J.M. Strelcyn, *On the non-existence of constants of derivations: the proof of a theorem of Jouanolou and its development*, Bull. Sci. Math. **119** (1995), 195–233.
- [80] V.V. Nemytskii and V.V. Stepanov, *Qualitative Theory of Differential Equations*, Dover, New York (1989).
- [81] D.A. Neumann, *Classification of continuous flows on 2-manifolds*, Proc. Amer. Math. Soc. **48** (1975), 73–81.
- [82] K. Odani, *The limit cycle of the van der Pol equation is not algebraic*, J. Differential Equations **115** (1995), 146–152.
- [83] P.J. Olver, *Applications of Lie Groups to Differential Equations*, Springer, New York (1986).
- [84] J.M. Pearson, N.G. Lloyd and C.J. Christopher, *Algorithmic derivation of centre conditions*, SIAM Rev. **38** (1996), 619–636.
- [85] J.V. Pereira, *Integrabilidade de equações diferenciais no plano complexo*, Monografias del IMCA, Vol. 25, Lima, Peru (2002).
- [86] H. Poincaré, *Sur l'intégration des équations différentielles du premier ordre et du premier degré I and II*, Rend. Circ. Mat. Palermo **5** (1891), 161–191; **11** (1897), 193–239.
- [87] M.J. Prelle and M.F. Singer, *Elementary first integrals of differential equations*, Trans. Amer. Math. Soc. **279** (1983), 613–636.
- [88] Qin Yuan-Xun, *On the algebraic limit cycles of second degree of the differential equation $dy/dx = \sum_{0 \leq i+j \leq 2} a_{ij} x^i y^j / \sum_{0 \leq i+j \leq 2} b_{ij} x^i y^j$* , Acta Math. Sinica **8** (1958), 23–35.
- [89] C. Rousseau and D. Schlomiuk, *Cubic vector fields symmetric with respect to a center*, J. Differential Equations **123** (1995), 388–436.
- [90] S. Schecter and M.F. Singer, *A class of vectorfields on S^2 that are topologically equivalent to polynomial vectorfields*, J. Differential Equations **57** (1985), 406–435.
- [91] D. Schlomiuk, *Elementary first integrals and algebraic invariant curves of differential equations*, Exposition. Math. **11** (1993), 433–454.
- [92] D. Schlomiuk, *Algebraic particular integrals, integrability and the problem of the center*, Trans. Amer. Math. Soc. **338** (1993), 799–841.
- [93] D. Schlomiuk, *Algebraic and geometric aspects of the theory of polynomial vector fields*, Bifurcations and Periodic Orbits of Vector Fields, D. Schlomiuk, ed. (1993), 429–467.
- [94] A.S. Shubé, *Partial integrals, integrability, and the center problem*, Differential Equations **32** (1996), 884–892.
- [95] M.F. Singer, *Liouvillian first integrals of differential equations*, Trans. Amer. Math. Soc. **333** (1992), 673–688.
- [96] J. Sotomayor, *Lições de Equações Diferenciais Ordinárias*, IMPA, Rio de Janeiro (1979).
- [97] J.M. Strelcyn and S. Wojciechowski, *A method of finding integrals for three-dimensional dynamical systems*, Phys. Lett. A **133** (1988), 207–212.
- [98] R. Sverdlove, *Inverse problems for dynamical systems*, J. Differential Equations **42** (1981), 72–105.
- [99] R.T. Valeeva, *Construction of a differential equation with given limit cycles and critical points*, Volz Math. Sb. **5** (1966), 83–85 (in Russian).

- [100] V. Volterra, *Leçons sur la théorie Mathématique de la lutte pour la vie*, Gauthier–Villars, Paris (1931).
- [101] S. Walcher, *On the Poincaré problem*, J. Differential Equations **166** (2000), 51–78.
- [102] J.A. Weil, *Constantes et polynômes de Darboux en algèbre différentielle : applications aux systèmes différentiels linéaires*, Ph.D., École Polytechnique (1995).
- [103] A.I. Yablonskii, *Limit cycles of a certain differential equations*, Differential Equations **2** (1966), 335–344 (in Russian).
- [104] Ye Yanqian, *Theory of Limit Cycles*, Translations of Math. Monographs, Vol. 66, Amer. Math. Soc., Providence (1986).
- [105] Zhang Zhifen, Ding Tongren, Huang Wenzao and Dong Zhenxi, *Qualitative Theory of Differential Equations*, Translations of Math. Monographs, Vol. 101, Amer. Math. Soc., Providence (1992).
- [106] H. Żołądek, *The solution of the center-focus problem*, Preprint (1992).
- [107] H. Żołądek, *On algebraic solutions of algebraic Pfaff equations*, Studia Math. **114** (1995), 117–126.

Global Results for the Forced Pendulum Equation

Jean Mawhin

Département de mathématique, Université Catholique de Louvain, B-1348 Louvain-la-Neuve, Belgium
E-mail: mawhin@amm.ucl.ac.be

Contents

1. Introduction	535
2. Autonomous pendulum equations	537
2.1. The free conservative pendulum	537
2.2. The free damped pendulum	539
2.3. The pendulum with constant torque	540
3. Periodic solutions of the forced pendulum	541
3.1. The problems	541
3.2. The possibly dissipative case $c \geq 0$	543
3.3. The conservative case $c = 0$	546
3.4. The dissipative case $c > 0$	551
3.5. The degeneracy problem	554
3.6. Multiplicity and stability results under restrictions of the coefficients	558
3.7. Many T -periodic solutions for special forcings	560
3.8. Many T -periodic solutions for small length pendulum	562
3.9. Subharmonic solutions when $c = 0$	563
4. Rotating solutions and Mather sets	565
4.1. Periodic solutions of the second kind	565
4.2. Solutions with an arbitrary rotation number	566
4.3. Mather set	570
5. KAM theory and Lagrange stability	571
5.1. Twist mappings	571
5.2. Chaotic dynamics	574
6. Bounded forcing	577
6.1. Bounded functions and their averages	577
6.2. A necessary condition for the existence of bounded solutions	577
6.3. Sufficient conditions for the existence of bounded solutions	578
6.4. Local uniqueness of bounded solutions	580
7. Almost periodic forcings	582
7.1. Almost periodic functions	582
7.2. Almost periodic solutions	583
References	585

HANDBOOK OF DIFFERENTIAL EQUATIONS

Ordinary Differential Equations, volume 1

Edited by A. Cañada, P. Drábek and A. Fonda

© 2004 Elsevier B.V. All rights reserved

This Page Intentionally Left Blank

1. Introduction

The obtention of global (i.e., nonperturbational) results for the forced pendulum equation started with the rigorous mathematical study of the periodic solutions of the periodically forced pendulum equation

$$y'' + \alpha^2 \sin y = \beta \sin t \quad (1)$$

initiated in 1922 by Georg Hamel, in a paper of the special issue of the *Mathematische Annalen* dedicated to Hilbert's sixtieth birthday anniversary [55].

Hamel's contribution starts by proving the existence of a 2π -periodic solution of Equation (1) through the *direct method of the calculus of variations*. He shows that the corresponding *action integral*

$$A(y) := \int_0^{2\pi} \left(\frac{y'(t)^2}{2} + \alpha^2 \cos y(t) + \beta y(t) \sin t \right) dt$$

has a minimum over the space of 2π -periodic C^1 -functions, and his argument easily extends to the case where $b \sin t$ is replaced by a continuous 2π -periodic function $h(t)$ with mean value zero. The *Ritz method* is then used to find a first approximation of the amplitude of the periodic solution.

Hamel then notices that the symmetries of the equation imply that any solution of Equation (1) satisfying the boundary conditions

$$y(0) = y(\pi) = 0 \quad (2)$$

can be extended as an *odd* 2π -periodic solution. The problem (1)–(2) is reduced to the *nonlinear integral equation*

$$y(t) = -\alpha^2 \int_0^{2\pi} K(t, \tau) \sin y(\tau) d\tau - \beta \sin t := F(y)(t), \quad (3)$$

where $K(t, \tau)$ is the Green function of

$$y'' = h(t), \quad y(0) = y(\pi) = 0.$$

The *method of successive approximations*

$$y_{n+1} = F(y_n), \quad y_0(t) = -b \sin t,$$

is shown to converge to a (unique) solution when $\alpha^2 < 1$. Hamel's argument is equivalent to proving the existence of a sufficiently large integer m , for which the m th iterate F^m of F is a contraction in the space $C([0, \pi])$.

When $\alpha^2 \geq 1$, Hamel uses *Lyapunov–Schmidt's method* to study the 2π -periodic solutions of (1) when $|b|$ is sufficiently small, and mentions the possibility of the existence of more than one 2π -periodic solution.

So, Hamel anticipates or uses several of the fundamental methods of nonlinear analysis, in a work which will not be essentially superseded during some sixty years.

An important role in renewing the interest to the forced pendulum equation was played by Fučík in the late nineteen seventies, when he wrote, in the Introduction of Chapter 26 of his monograph [49]:

Finally we shall present here one attempt to obtain the existence of a T -periodic solution of the mathematical pendulum equation

$$-u''(t) + \sin u(t) = f(t). \quad (4)$$

The result is not final since the necessary and sufficient condition obtained for T -periodic solvability of (4) is not useful.

After describing very partial results in this direction and mentioning extensions personally communicated by Dancer, Fučík concluded that the

description of the set \mathcal{P} of f for which the equation $u'' + \sin u = f(t)$ has a T -periodic solution seems to remain a *terra incognita*.

Motivated by Fučík's remarks, but unaware of the existence of Hamel's paper, Castro [32] (for $\alpha \leq 1$), Dancer [36] and Willem [129], independently (for arbitrary α), reintroduced in the early eighties the use of the direct method of the calculus of variations, in the setting of Sobolev spaces. The time was ripe for the obtention by Mawhin and Willem [85], some sixty years after the first one, of a *second periodic solution*, using a refinement of the *mountain pass lemma*.

At the same time, the forced pendulum equation also became a paradigm for the *theory of chaos*, and appeared in the description of *Josephson type junctions*. We only describe global results in this direction here, and refer to the bibliography of [82,117] for the numerous perturbational and numerical aspects.

A fundamental role in the development of the qualitative theory of nonlinear differential equations and its applications to engineering, was also played by the *pendulum equation with a constant torque* or *Tricomi's equation*

$$y'' + cy' + a \sin y = b,$$

introduced by Tricomi [125,126] in his studies of synchronous electrical machines, and widely developed since (see [83] for references).

To keep the size of the survey reasonable and facilitate the comparison between results obtained through different methods, we only state the theorems for the standard (possibly dissipative) forced pendulum equation

$$y'' + cy' + a \sin y = h(t).$$

Most of the assertions remain valid if $a \sin y$ is replaced by an arbitrary continuous S -periodic function $g(y)$ with mean value zero. Recent results depend upon the fact that $a \sin y$ is replaced by a S -periodic function whose Fourier series contains higher harmonics [63]. Also, some conclusions survive when the friction term cy' is replaced by a more

general one of Liénard type $f(y)y'$ or of Rayleigh type $f(y')$. See the references in [82] and the recent papers [52,54].

For the same reason of brevity, we will not describe the possible generalizations to *systems of pendulum-type*, and in particular to the equations of the *forced multiple pendulum*, and to *higher order pendulum-type equations*. The reader can consult the bibliography in [82] and the recent paper [116]. We shall also leave aside the existence of forced oscillations of the *spherical pendulum* (which depends upon methods of a quite different nature), considered by Furi, Pera and Spadini, and the pendulum-type equations describing the *libration of satellites*. Again, references to the corresponding literature for those questions can be found in [82].

Let us mention also that the corresponding problem for the case of *Dirichlet boundary conditions*, namely

$$y'' + y + a \sin y = h(t), \quad y(0) = 0 = y(\pi),$$

and its analog for partial differential equations, has been the object, since the pioneering papers of Ward [128] using critical point theory, and of Schaaf and Schmitt [118] using global bifurcation, of a number of studies by Arcoya, Cañada, Lupo, Roca, Ruiz, Solimini, Ureña and others. References can be found in [82] and in the more recent contributions [28–31]. This problem, which has both deep analogies and strong differences with the periodic boundary value problem for the forced pendulum, will not be considered here.

Finally, in order to keep the number of references at a reasonable level, we have only quoted the papers whose results are directly mentioned in this survey. Further bibliographical information can be found in [82].

2. Autonomous pendulum equations

2.1. The free conservative pendulum

To allow the evaluation of the subsequent results, let us briefly recall the structure of the solution set of the *free conservative pendulum equation*

$$y'' + a \sin y = 0, \tag{5}$$

where $a > 0$. This information can easily be obtained from the *energy integral*

$$\frac{y'^2}{2} - a \cos y = C, \tag{6}$$

by studying the orbits (y, y') in the phase-plane (or in the phase-cylinder $S^1 \times \mathbb{R}$). Equation (5) admits two geometrically distinct *equilibria*, namely

$$(y(t), y'(t)) \equiv (0, 0), \quad (y(t), y'(t)) \equiv (\pi, 0).$$

The orbits through $(A, 0)$, with $0 < y(0) = A < \pi$ are closed and surround the equilibrium $(0, 0)$, which is therefore a *center*. They correspond to *periodic solutions* of (5) with maximum amplitude A and maximum velocity $\sqrt{2a(1 - \cos A)}$. Their period

$$T(A) = 2\sqrt{2} \int_0^A \frac{dy}{\sqrt{a(\cos y - \cos A)}}$$

is an increasing function such that

$$\lim_{A \rightarrow 0^+} T(A) = \frac{2\pi}{\sqrt{a}}, \quad \lim_{A \rightarrow \pi^-} T(A) = +\infty. \quad (7)$$

Physically, those periodic solutions correspond to *oscillations* of the pendulum around its stable equilibrium position.

The orbits through $(0, B)$ with $B > 2\sqrt{a}$ (respectively $B < -2\sqrt{a}$) are the periodic curves

$$y' = \pm [B^2 - 2a(1 - \cos y)]^{1/2} \quad (8)$$

in the upper (respectively lower) phase-plane (or closed curves surrounding the phase-cylinder). So $y(t)$ is strictly monotone and its inverse function $t(y)$, given by

$$t(y) = \pm \int_0^y \frac{ds}{[B^2 - 2a(1 - \cos s)]^{1/2}},$$

is the indefinite integral of a 2π -periodic function. Thus, if we define

$$\tau(B) := \int_0^{2\pi} \frac{dy}{\sqrt{B^2 - 2a(1 - \cos y)}}, \quad (9)$$

$t(y)$ has the form

$$t(y) = \pm \left(\frac{\tau(B)}{2\pi} y + P(y) \right),$$

with P a 2π -periodic function. Therefore,

$$\frac{\tau(B)}{2\pi}(y + 2\pi) + P(y + 2\pi) = \tau(B) + \frac{\tau(B)}{2\pi}y + P(y) = \tau(B) + t,$$

which shows that

$$y(t + \tau(B)) = y(t) + 2\pi \quad (t \in \mathbb{R}),$$

and hence, by (8),

$$y'(t + \tau(B)) = y'(t) \quad (t \in \mathbb{R}).$$

Such a y is called a *periodic solution of the second kind* of Equation (5). The function $\tau(B)$ is such that

$$\lim_{B \rightarrow 2\sqrt{a}^+} \tau(B) = +\infty, \quad \lim_{B \rightarrow +\infty} \tau(B) = 0.$$

Physically, those solutions correspond to *rotations* of the pendulum.

Finally, the orbit through $(0, 2\sqrt{a})$ (respectively $(0, -2\sqrt{a})$) connects in the upper (respectively lower) half phase-space the equilibria $(-\pi, 0)$ and $(\pi, 0)$ (*heteroclinic orbits*) (or *homoclinic orbits* connecting $(\pi, 0)$ to itself in the phase-cylinder). Thus $(\pi, 0)$ is a *saddle point*. Those orbits correspond to positive (respectively negative) *asymptotic solutions* y of (5) such that

$$\lim_{t \rightarrow -\infty} y(t) = -\pi, \quad \lim_{t \rightarrow +\infty} y(t) = \pi$$

(respectively

$$\lim_{t \rightarrow -\infty} y(t) = \pi, \quad \lim_{t \rightarrow +\infty} y(t) = -\pi),$$

and

$$\lim_{t \rightarrow \pm\infty} y'(t) = 0.$$

Physically, those solutions correspond to motions which are *asymptotic* (in the past or in the future) to the unstable vertical equilibrium.

Notice that, if $T \leq \frac{2\pi}{\sqrt{a}}$, the only T -periodic solutions of Equation (5) are the equilibria $y \equiv 0$ and $y \equiv \pi$. If $T > \frac{2\pi}{\sqrt{a}}$, and if $m \geq 1$ is the largest integer such that $\frac{T}{m} > \frac{2\pi}{\sqrt{a}}$, in other words if

$$m = \left[\frac{T\sqrt{a}}{2\pi} \right],$$

where $[s]$ denotes the integer part of s , then Equation (5) has, besides the two equilibria, nontrivial T -periodic solutions corresponding to the closed orbits of amplitude A_k such that

$$T(A_k) = \frac{T}{k} \quad (k = 1, 2, \dots, m).$$

2.2. The free damped pendulum

The study of the *free damped pendulum*

$$y'' + cy' + a \sin y = 0, \tag{10}$$

where, without loss of generality, we assume $c > 0$ and $a > 0$, is more delicate, as no energy integral exists. Equation (10) still admits the constant solutions

$$y \equiv 0, \quad y \equiv \pi,$$

but has no nonconstant T -periodic solution of any period T . Indeed, if y is a T -periodic solution of (10), integrating the identity

$$y''y' + cy'^2 + (a \sin y)y' = 0,$$

over $[0, T]$, and using the periodicity gives

$$c \int_0^T (y'(t))^2 dt = 0.$$

Thus $y' = 0$, and $y = 0 \pmod{\pi}$.

Now, the variational equation around the zero equilibrium

$$z'' + cz' + az = 0$$

has characteristic roots which are both real and negative if $c \geq 2\sqrt{a}$ and complex conjugate with negative real part if $c < 2\sqrt{a}$. Thus the zero equilibrium is *asymptotically stable*. The variational equation around the equilibrium $y \equiv \pi$

$$z'' + cz' - az = 0$$

has a positive and a negative characteristic root. It is unstable of *saddle point* type.

Using the Lyapunov function

$$V(y, z) = z^2 + (cy + z)^2 + 4a(1 - \cos y),$$

for the associated first order system obtained in letting $y' = z$ in (10), one can show that, in the phase-cylinder, with the exception of the two orbits which constitute the stable manifold of the saddle point $(\pi, 0)$, all other orbits correspond to solutions tending to $(0, 0)$ when $t \rightarrow +\infty$. The stable equilibrium $(0, 0)$ is a focus or a node according to $c < 2\sqrt{a}$ or $c \geq 2\sqrt{a}$.

Thus Equation (10) has no nonconstant periodic solution, no periodic solution of the second kind, no homoclinic orbit. It has two heteroclinic orbits connecting $(\pi, 0)$ to $(0, 0)$ and corresponding to the unstable manifolds of the saddle point $(\pi, 0)$. We refer to [6] for the corresponding phase plane or phase cylinder portraits.

2.3. The pendulum with constant torque

The differential equation of the *conservative pendulum with constant torque* is

$$y''(t) + a \sin y(t) = b, \tag{11}$$

where $a > 0$, $b > 0$, and its energy integral

$$\frac{y'^2(t)}{2} - a \cos y(t) - by = C \quad (C \in \mathbb{R}), \quad (12)$$

gives the equations of the family of the orbits of (11) in the phase space (y, y') .

Equation (11) has zero, one unstable ($y(t) \equiv \pi/2$), or one stable ($y(t) \equiv \arcsin(b/a)$) and one unstable ($y(t) \equiv \pi - \arcsin(b/a)$) equilibria, according to $b > a$, $b = a$ or $b < a$. If $b < a$, Equation (11) has T -periodic solutions for each $T \in]2\pi/\sqrt{a^2 - b^2}, +\infty[$, and, if $b \geq a$, Equation (11) has no (nonconstant) T -periodic solution. If $b < a$, Equation (11) has one homoclinic orbit to the saddle point $(\pi, 0)$ and no homoclinic orbit if $b \geq a$. Finally, Equation (11) has no heteroclinic orbit and no periodic solution of the second kind. See [6] for more details and corresponding phase portraits.

The differential equation of the *damped pendulum with constant torque*

$$y'' + cy' + a \sin y = b, \quad (13)$$

where $a > 0$, $b > 0$, $c > 0$, is also the equation of synchronous electrical motors considered by Tricomi in [125,126]. Because of the absence of a first integral, the discussion of its qualitative behavior in the phase space or phase cylinder is much more delicate, and, in contrast to the undamped case, periodic solutions of the second kind may exist.

Equation (13) has no, one unstable or one stable and one unstable (saddle point) equilibrium, according to $b > a$, $b = a$ or $b < a$. It has no nonconstant T -periodic solution and no homoclinic orbit. For $b > a$, it has no heteroclinic orbit, and one periodic solution of the second kind, with $y'(t) > 0$ for all $t \in \mathbb{R}$. For $b \leq a$, there exists $c_0 > 0$ such that Equation (13) has no periodic solution of the second kind and two heteroclinic orbits if $c > c_0$, and one periodic solution of the second kind and one heteroclinic orbit if $c \leq c_0$. The effective determination of c_0 is an important and delicate problem.

3. Periodic solutions of the forced pendulum

3.1. The problems

We now consider the (possibly dissipative) *periodically forced pendulum equation*

$$y'' + cy' + a \sin y = h(t) \quad (= \bar{h} + \tilde{h}(t)), \quad (14)$$

where we can assume, without loss of generality, that $c \geq 0$, $a > 0$, and where $h = \bar{h} + \tilde{h}$ is T -periodic, for some period $T > 0$, and corresponding frequency $\omega := \frac{2\pi}{T}$. For the simplicity of exposition, we assume that h is continuous. Most results hold under weaker regularity conditions.

We use the following notations:

$$L_T^p = \{h \in L_{\text{loc}}^p(\mathbb{R}): h(t+T) = h(t) \text{ for a.e. } t \in \mathbb{R}\},$$

$$\begin{aligned}
 H^1([0, T]) &= \{h \in AC([0, T]): h' \in L^2([0, T])\}, \\
 C_T &= \{h \in C(\mathbb{R}): h(t + T) = h(t) \text{ for all } t \in \mathbb{R}\}, \\
 H_T^1 &= \{h \in AC_{\text{loc}}(\mathbb{R}) \cap C_T: h' \in L^2([0, T])\}, \\
 \|h\|_p &= \left(\int_0^T |h(t)|^p dt \right)^{1/p}, \quad \|h\|_\infty = \max_{t \in [0, T]} |h(t)|, \\
 \|h\|_{H^1([0, T])} &= \|h\|_{H_T^1} = (\|h\|_2^2 + \|h'\|_2^2)^{1/2}, \\
 \bar{h} &= \frac{1}{T} \int_0^T h(t) dt, \quad \tilde{h}(t) = h(t) - \bar{h}, \\
 \tilde{L}_T^p &= \{h \in L_T^p: \bar{h} = 0\}, \quad \tilde{C}_T = \{h \in C_T: \bar{h} = 0\}.
 \end{aligned}$$

Consequently,

$$L_T^p = R \oplus \tilde{L}_T^p, \quad C_T = R \oplus \tilde{C}_T,$$

with the corresponding decomposition $y = \bar{y} + \tilde{y}$.

DEFINITION 1. A T -periodic solution of Equation (14) is a solution $y: \mathbb{R} \rightarrow \mathbb{R}$ such that $y(t + T) = y(t)$ for all $t \in \mathbb{R}$.

We will sometimes use an interesting *equivalent formulation* of the problem of T -periodic solutions for Equation (14).

LEMMA 1. If $\tilde{H}(t)$ denotes the unique T -periodic solution in \tilde{C}_T of equation

$$y'' + cy' = \tilde{h}, \tag{15}$$

then $y(t)$ is a T -periodic solution of Equation (14) if and only if $x(t) = y(t) - \tilde{H}(t)$ is a T -periodic solution of equation

$$x'' + cx' + a \sin(x + \tilde{H}(t)) = \tilde{h}. \tag{16}$$

When h is not constant, Equation (14) has no constant solution, and one expects that the equilibria will be replaced by T -periodic solutions. By integrating Equation (14) over $[0, T]$, we immediately obtain a *necessary condition* for the existence of a T -periodic solution to Equation (14).

PROPOSITION 1. If Equation (14) has a T -periodic solution, then

$$-a \leq \bar{h} \leq a. \tag{17}$$

The main questions one can raise about the T -periodic solutions of Equation (14) are the following ones:

1. Determine the *nature* and the *properties* of the set

$$\mathcal{R} = \mathcal{R}(c, a, T) \subset [-a, a] \oplus \tilde{C}_T$$

of T -periodic forcings h such that Equation (14) has at least one T -periodic solution, i.e., the *range* of the nonlinear operator

$$\frac{d^2}{dt^2} + c \frac{d}{dt} + a \sin(\cdot)$$

over the space of C^2 T -periodic functions.

2. For $h \in \mathcal{R}$, discuss the *multiplicity* of the T -periodic solutions.
3. For $h \in \mathcal{R}$, discuss the *stability* of the T -periodic solutions.
4. Discuss the existence of *subharmonic solutions*, i.e., solutions with minimum period kT for some integer $k \geq 2$.

Concerning the multiplicity, it is clear that if y is a T -periodic solution of Equation (14), the same is true for $y + 2k\pi$, $k \in \mathbb{Z}$. Consequently, we say that y_1 and y_2 are *geometrically distinct* T -periodic solutions of (14) if they do not differ by a multiple of 2π .

3.2. The possibly dissipative case $c \geq 0$

The *Lyapunov–Schmidt’s decomposition* (see, e.g., [50]) consists in the following elementary fact.

LEMMA 2. $y = \bar{y} + \tilde{y}$ is a T -periodic solution of Equation (14) if and only if it is a solution of the system

$$\tilde{y}'' + c\tilde{y}' + a \sin(\bar{y} + \tilde{y}) - \overline{a \sin(\bar{y} + \tilde{y})} = \tilde{h}(t), \quad (18)$$

$$\overline{a \sin(\bar{y} + \tilde{y})} = \bar{h}. \quad (19)$$

Of course, instead of $y = \bar{y} + \tilde{y}$, one can also decompose y as $y = y(\tau) + [y - y(\tau)]$, for some $\tau \in \mathbb{R}$.

In the classical Liapunov–Schmidt’s method, the first equation in (18) is solved with respect to \tilde{y} for fixed \bar{y} (using a fixed point or implicit function theorem, or critical point theory) and this solution is introduced in the second equation, which then becomes the (one-dimensional) *bifurcation equation*. One can also study directly the equivalent system (18)–(19) by *degree* or *critical point theory*.

The *method of upper and lower solutions* for the periodic solutions of Equation (14) (see, e.g., [76]) consists in the following statement.

LEMMA 3. If α and β are of class C^2 , T -periodic and such that, for all $t \in \mathbb{R}$,

$$\begin{aligned} \alpha(t) &\leq \beta(t), \\ \alpha''(t) + c\alpha'(t) + a \sin \alpha(t) &\geq h(t) \geq \beta''(t) + c\beta'(t) + a \sin \beta(t), \end{aligned} \quad (20)$$

then (14) has at least one T -periodic solution y such that $\alpha(t) \leq y(t) \leq \beta(t)$.

Furthermore, if the inequalities are strict in (20), the coincidence degree of the T -periodic boundary value problem for (14) with respect to the open bounded set

$$\Omega = \{y \in C_T : \forall t \in \mathbb{R}, \alpha(t) < y(t) < \beta(t)\}$$

is defined and equal to one.

The coincidence degree is the Leray–Schauder degree of a suitable associated nonlinear operator in C_T , whose fixed points give the T -periodic solutions of (14). See, e.g., [50,74].

The following results are now classical and can be found in [85,47,76]. Some of them were first proved in [36] and some have been reobtained in [61]. We recall first the main ideas and results of the used methods.

THEOREM 1. *For each $\tilde{h} \in \tilde{C}_T$, there exists*

$$m_{\tilde{h}} = m_{\tilde{h}}(c, a, T) \leq M_{\tilde{h}} = M_{\tilde{h}}(c, a, T)$$

such that the following hold.

1. Equation (14) has at least one T -periodic solution if and only if $\tilde{h} \in [m_{\tilde{h}}, M_{\tilde{h}}]$.
2. $-a \leq m_{\tilde{h}} \leq M_{\tilde{h}} \leq a$, $m_0 = -a$, $M_0 = a$.
3. $\mathcal{R}(c, a, T) = \bigcup_{\tilde{h} \in \tilde{C}_T} [m_{\tilde{h}}, M_{\tilde{h}}] \times \{\tilde{h}\} \subset [-a, a] \oplus \tilde{C}_T$ is closed.
4. Equation (14) has at least two distinct T -periodic solutions if $\tilde{h} \in]m_{\tilde{h}}, M_{\tilde{h}}[$.

To prove this theorem, one first uses the Lyapunov–Schmidt decomposition. Leray–Schauder’s fixed point theorem applied to an integral formulation of (18) in the space \tilde{C}_T with parameter $\tilde{y} \in S^1$ implies the existence of a connected closed set $\mathcal{C}(c, a, T, \tilde{h}) \subset S^1 \times \tilde{C}_T$ of solutions (\tilde{y}, \tilde{y}) of (18), whose projection on S^1 is equal to S^1 . Hence, Equation (14) has at least one T -periodic solution if \tilde{h} belongs to the nonempty set

$$\mathcal{I}(c, a, T, \tilde{h}) = \{\overline{a \sin(\tilde{y} + \tilde{y})} : (\tilde{y}, \tilde{y}) \in \mathcal{C}(c, a, T, \tilde{h})\}.$$

The fact that $\mathcal{I}(c, a, T, \tilde{h})$ is an interval follows from the fact that if $\tilde{h}_1 < \tilde{h}_2$ belong to $\mathcal{I}(c, a, T, \tilde{h})$, and if $\tilde{h} \in]\tilde{h}_1, \tilde{h}_2[$, then a corresponding solution $y_i = \tilde{y}_i + \tilde{y}_i$ of equation

$$y'' + cy' + a \sin y = \tilde{h}_i + \tilde{h} \quad (i = 1, 2)$$

satisfies the equations

$$\begin{aligned} \tilde{y}_i'' + c\tilde{y}_i' + a \sin(\tilde{y}_i + \tilde{y}_i) - \overline{a \sin(\tilde{y}_i + \tilde{y}_i)} &= \tilde{h}(t), \\ \overline{a \sin(\tilde{y}_i + \tilde{y}_i)} &= \tilde{h}_i \quad (i = 1, 2), \end{aligned}$$

and hence $(\tilde{y}_i, \tilde{y}_i) \in \mathcal{C}(c, a, T, \tilde{h})$ ($i = 1, 2$) and are such that

$$\overline{a \sin(\tilde{y}_1 + \tilde{y}_1)} < \tilde{h} < \overline{a \sin(\tilde{y}_2 + \tilde{y}_2)}.$$

As the real map

$$(\bar{y}, \tilde{y}) \mapsto \overline{a \sin(\bar{y} + \tilde{y})} \tag{21}$$

is continuous, there exists, by connexity, some $(\bar{y}, \tilde{y}) \in \mathcal{C}(c, a, T, \tilde{h})$ such that

$$\overline{a \sin(\bar{y} + \tilde{y})} = \tilde{h},$$

and $y = \bar{y} + \tilde{y}$ is a T -periodic solution of Equation (14). We set

$$m_{\tilde{h}} = \inf \mathcal{I}(c, a, T, \tilde{h}), \quad M_{\tilde{h}} = \sup \mathcal{I}(c, a, T, \tilde{h}).$$

It follows from (17) that $-a \leq m_{\tilde{h}} \leq M_{\tilde{h}} \leq a$, and it is trivial that $m_0 = -a$ and $M_0 = a$.

To prove that $\mathcal{R}(c, a, T)$ is closed, one considers a sequence (h_i) in $\mathcal{R}(c, a, T)$ converging uniformly to $h \in C_T$, and (\bar{y}_i, \tilde{y}_i) a corresponding sequence in $S^1 \times \tilde{C}_T$ of T -periodic solutions. It is easy to show from (18) that (\bar{y}_i) is bounded in C_T^2 , and Ascoli–Arzelá theorem implies that, up to a subsequence, $(\bar{y}_i + \tilde{y}_i)$ converges to some T -periodic solution y of Equation (14). This implies that $\mathcal{I}(c, a, T, \tilde{h})$ is closed.

To prove the multiplicity result when $m_{\tilde{h}} < \tilde{h} < M_{\tilde{h}}$, we observe that in this case, if y_m (respectively y_M) is a T -periodic solution of Equation (14) with $h = m_{\tilde{h}} + \tilde{h}$ (respectively $h = M_{\tilde{h}} + \tilde{h}$), then y_m (respectively y_M) is an strict upper (respectively lower) solution for Equation (14) with periodic boundary conditions. As Equation (14) is invariant under the substitution $y \rightarrow y + 2k\pi$ ($k \in \mathbb{Z}$), we can assume without loss of generality that $y_M(t) \leq y_m(t)$ for all $t \in \mathbb{R}$ and that $y_m(\tau) - y_M(\tau) < 2\pi$ for some $\tau \in \mathbb{R}$. An easy maximum principle type reasoning then shows that $y_M(t) < y_m(t)$ for all $t \in \mathbb{R}$. Hence Lemma 3 implies that (14) has at least one T -periodic solution \hat{y}_1 such that

$$y_M(t) < \hat{y}_1(t) < y_m(t) \tag{22}$$

for all $t \in \mathbb{R}$, and such that the associated coincidence degree with respect to the open set

$$\Omega_1 = \{y \in C_T: \forall t \in \mathbb{R}, y_M(t) < y(t) < y_m(t)\},$$

is equal to one. Now, $(y_M + 2\pi, y_m + 2\pi)$ and $(y_M, y_m + 2\pi)$ are also two strictly ordered couples of lower and upper solution for Equation (14) with T -periodic boundary conditions. Consequently, the coincidence degree respectively associated to the T -periodic boundary value problem for Equation (14) with respect to the open sets

$$\Omega_2 = \{y \in C_T: \forall t \in \mathbb{R}, y_M(t) + 2\pi < y(t) < y_m(t) + 2\pi\}$$

and

$$\Omega_3 = \{y \in C_T: \forall t \in \mathbb{R}, y_M < y(t) < y_m + 2\pi\}$$

are equal to one. As

$$\Omega_1 \subset \Omega_3, \quad \Omega_2 \subset \Omega_3, \quad \overline{\Omega}_1 \cap \overline{\Omega}_2 = \emptyset,$$

it follows from its additivity property that the coincidence degree associated to the T -periodic boundary value problem for Equation (14) with respect to the open set $\Omega_3 \setminus (\overline{\Omega}_1 \cup \overline{\Omega}_2)$ is equal to -1 , and Equation (14) has at least one T -periodic solution $\hat{y}_2 \in \Omega_3 \setminus (\overline{\Omega}_1 \cup \overline{\Omega}_2)$. By construction, \hat{y}_1 and \hat{y}_2 do not differ by a multiple of 2π .

3.3. The conservative case $c = 0$

In the conservative case

$$y'' + a \sin y = h(t) \quad (= \bar{h} + \tilde{h}(t)), \tag{23}$$

the *direct method of the calculus of variations* allows to prove that $0 \in [m_{\bar{h}}, M_{\bar{h}}]$. The starting point of this approach or of any application of *critical point theory* to the periodic solutions of the forced pendulum equation without dissipation is the following classical observation.

LEMMA 4. y is a T -periodic solution of Equation (23) if and only if y is a critical point of the action functional

$$A_h : H_T^1 \rightarrow \mathbb{R}, \quad y \mapsto \int_0^T \left(\frac{y'^2(t)}{2} + a \cos y(t) + h(t)y(t) \right) dt. \tag{24}$$

If convenient, we also write $A_h(\bar{y}, \tilde{y})$ instead of $A_h(y)$. We recall a few definitions and results. Let E be a Banach space and $\varphi \in C^1(E, \mathbb{R})$. We denote its Fréchet differential at y by $\varphi'(y)$, and its value at $v \in E$ by $\langle \varphi'(y), v \rangle$.

DEFINITION 2. $y \in E$ is a *critical point* of φ if $\varphi'(y) = 0$. $c \in \mathbb{R}$ is a *critical value* of φ if $c = \varphi(y)$ for some critical point y of φ .

We recall a classical and easy to prove sufficient condition for the existence of a minimum to φ .

PROPOSITION 2. Let E be a reflexive Banach space and $\varphi \in C^1(E, \mathbb{R})$ be bounded from below and sequentially weakly lower semi-continuous. Then φ has a minimum on E .

A slight extension of Hamel’s result [55,129,36] follows from Proposition 2.

THEOREM 2. For each $\tilde{h} \in \tilde{C}_T$, Equation (23) has at least one T -periodic solution which minimizes A_h over H_T^1 . In other words, $0 \in [m_{\tilde{h}}, M_{\tilde{h}}]$.

First observe that if $\bar{h} = 0$, A_h is 2π -periodic and, using the Sobolev inequality for $y = \bar{y} + \tilde{y} \in H_T^1$,

$$\max_{[0, T]} |\tilde{y}| \leq \frac{T^{1/2}}{2\sqrt{3}} \|y'\|_{L^2}, \tag{25}$$

we get

$$\begin{aligned} \varphi(y) &= \int_I \left[\frac{y'^2(t)}{2} + a \cos y(t) + \tilde{h}(t)\tilde{y}(t) \right] dt, \\ &\geq \frac{1}{2} \int_I |y'(t)|^2 dt - aT - \left(\int_I |\tilde{h}(t)| dt \right) \max_I |\tilde{y}| \\ &\geq \frac{1}{2} \int_I |y'(t)|^2 dt - aT - \left(\int_0^T |\tilde{h}(t)| dt \right) \frac{T^{1/2}}{2\sqrt{3}} \left(\int_I |y'(t)|^2 dt \right)^{1/2}. \end{aligned} \tag{26}$$

This shows that A_h is bounded from below. From the sequential weak lower semicontinuity of the map $y \mapsto \int_0^T |y'(t)|^2 dt$, and the compact embedding of H_T^1 into C_T , it is easy to show that A_h is sequentially weakly lower semi-continuous.

The existence of a *second solution* for the conservative forced pendulum when $\bar{h} = 0$ can be proved by a *generalized mountain pass lemma*, which extends both the geometrical and the compactness assumptions of the classical *Ambrosetti–Rabinowitz mountain pass lemma* [4]. This abstract extension, due to Ghoussoub–Preiss [51] and Yihong Du [42], was motivated by the first proof of a second T -periodic solution to Equation (23) given in [85], as it was the case for the slightly less general version given earlier by Pucci–Serrin [113]. We first introduce two definitions.

DEFINITION 3. A *Palais–Smale sequence at level $c \in \mathbb{R}$* for $\varphi \in C^1(E, \mathbb{R})$ is a sequence (y_n) in E such that

$$\varphi(y_n) \rightarrow c, \quad \varphi'(y_n) \rightarrow 0, \quad \text{if } n \rightarrow \infty.$$

The function φ satisfies the *(PS) $_c$ -condition* if the existence of a Palais–Smale sequence at level c for φ implies that c is a critical value for φ .

DEFINITION 4. The function $\varphi \in C^1(E, \mathbb{R})$ satisfies the *Palais–Smale condition (PS)* (respectively the *bounded Palais–Smale condition (BPS)*) if any sequence (respectively bounded sequence) (y_n) such that $(\varphi(y_n))$ is bounded and $\varphi'(y_n) \rightarrow 0$ has a convergent subsequence.

We now state the *generalized mountain pass lemma*.

LEMMA 5. Let $d, e \in E$, $0 < r < \|e - d\|$, be such that

$$a := \max\{\varphi(d), \varphi(e)\} \leq b := \inf_{r \leq \|y-d\| \leq R} \varphi(y). \tag{27}$$

Let

$$\Gamma = \{ \gamma \in C([0, 1], E) : \gamma(0) = d, \gamma(1) = e \},$$

$$c := \inf_{\gamma \in \Gamma} \sup_{s \in [0, 1]} \varphi(\gamma(s)).$$

Then $c \geq b$, and if φ satisfies the $(PS)_c$ and (BPS) conditions, c is a critical value for φ . Moreover, if $c = a$, there is a critical point z such that $\varphi(z) = c$ and $\|z - d\| = r$.

The original mountain pass lemma requires that $a < b$ and that the classical Palais–Smale compactness condition holds.

To apply this Lemma 5 to A_h when $h \in \tilde{C}_T$, the most technical part is to check that A_h verifies the Palais–Smale-type conditions.

LEMMA 6. *If $h \in \tilde{C}_T$, A_h satisfies the (BPS)-condition and the $(PS)_c$ -condition for each $c \in \mathbb{R}$.*

To show the (BPS)-condition, assume that $(A'_h(y_n))$ converges to 0 and (y_n) is bounded in H_T^1 . Then, up to a subsequence, (y_n) converges weakly in H_T^1 and uniformly on I to some $y \in H_T^1$. Consequently

$$\langle A'_h(y_n) - A'_h(y), y - y_n \rangle \rightarrow 0,$$

as $n \rightarrow \infty$. But

$$\begin{aligned} & \langle A'_h(y_n) - A'_h(y), y - y_n \rangle \\ &= \int_I |y'_n(t) - y'(t)|^2 dt - a \int_I [\sin y_n(t) - \sin y(t)][y_n(t) - y(t)] dt, \end{aligned}$$

and

$$\int_I [\sin y_n(t) - \sin y(t)][y_n(t) - y(t)] dt \rightarrow 0$$

as $n \rightarrow \infty$. Consequently,

$$\int_I |y'_n(t) - y'(t)|^2 dt \rightarrow 0,$$

as $n \rightarrow \infty$, and hence $y_n \rightarrow y$ in H_T^1 . Thus A_h satisfies the (BPS)-condition. Finally, let (y_n) be such that $A_h(y_n) \rightarrow c$ and $A'_h(y_n) \rightarrow 0$ as $n \rightarrow \infty$. Thus $(A_h(y_n))$ is bounded and, using (26) we see that $(\|y'_n\|_{L^2})$ is bounded. Now, by 2π -periodicity of A_h , there exists $z_n \in [0, 2\pi[$ such that $z_n = \bar{y}_n \pmod{2\pi}$. Letting $w_n(t) = z_n + \tilde{y}_n(t)$, we have $A_h(y_n) = A_h(w_n)$, $A'_h(y_n) = A'_h(w_n)$ and (w_n) is bounded in H_T^1 . By the reasoning for

(BPS) applied to this sequence, we see that, up to a subsequence, $w_n \rightarrow w \in H_T^1$ and this easily implies that c is a critical value of A_h .

We can now prove the existence of a second T -periodic solution.

THEOREM 3. *For each $h \in \tilde{C}_T$, Equation (23) has at least two geometrically distinct T -periodic solutions.*

A first solution y^* has been obtained which minimizes A_h over H_T^1 . To obtain a second one, it remains to check the geometry of the generalized mountain pass lemma. As

$$A_h(y^*) = A_h(y^* + 2\pi) = \min_{H_T^1} A_h,$$

let us take $0 < r < 2\pi$, $d = y^*$, $e = y^* + 2\pi$. Then, all conditions of Proposition 5 are satisfied. If the critical value $c > \min_{H_T^1} A_h$, then the corresponding critical point is geometrically distinct from y^* . If $c = \min_{H_T^1} A_h$, then A_h has a critical point z such that $0 < \|z - y^*\| = r < 2\pi$, so that y^* and z are two geometrically distinct T -periodic solutions of Equation (23).

The periodicity property of A_h when $\bar{h} = 0$ allows also the use of a *Lusternik–Schnirelman type* argument to prove directly that A_h has two distinct critical points (see [78,34,114]). Let G be a discrete subgroup of a Banach space E and $\pi : E \rightarrow E/G$ be the canonical surjection.

DEFINITION 5. $A \subset X$ is called G -invariant if $\pi^{-1}(\pi(A)) = A$. $\varphi : E \rightarrow \mathbb{R}$ is called G -invariant if $\varphi(y + g) = \varphi(y)$ for every $y \in E$ and every $g \in G$.

When φ is differentiable, the same G -invariance holds for φ' , so that if y is a critical point of φ , then $\pi^{-1}(\pi(y))$ is a set of critical point of φ , called a *critical orbit* of φ . A suitable Palais–Smale condition for G -invariant functions is the following one.

DEFINITION 6. A G -invariant differentiable functional $\varphi : E \rightarrow \mathbb{R}$ satisfies the $(PS)_G$ -condition if, for every sequence (y_k) in E such that $(\varphi(y_k))$ is bounded and $\varphi'(y_k) \rightarrow 0$, the sequence $(\pi(y_k))$ contains a convergent subsequence.

The following multiplicity theorem holds for G -invariant functionals [114]. Its proof is based upon Lusternik–Schnirelman category [86].

PROPOSITION 3. *Let $\varphi \in C^1(E, \mathbb{R})$ be a G -invariant functional satisfying the $(PS)_G$ -condition. If φ is bounded from below and G generates a subspace of finite dimension N , then φ has at least $N + 1$ critical orbits.*

If we consider A_h with $h \in \tilde{C}_T$, so that $A_h(y + 2\pi) = A_h(y)$ for all $y \in H_T^1$, we can take the discrete subgroup $G = \{2k\pi : k \in \mathbb{Z}\}$ of H_T^1 . If $y = \bar{y} + \tilde{y} \in H_T^1$, there exists a unique $k \in \mathbb{Z}$ such that $\bar{y}_0 := \bar{y} - 2k\pi \in [0, 2\pi[$, and $\bar{y}_0 + \tilde{y}$ is a representative of $[y] \in H_T^1/G$.

So the $(PS)_G$ -condition for A_h essentially reduces to the (BPS)-condition checked above. Proposition 3 gives another proof of Theorem 3.

In [119], Serra and Tarallo have introduced a new *reduction method of Liapunov-Schmidt's type*, which provides equivalent formulations for some of problems for the forced conservative pendulum equation. One first observes that, for each $\xi \in \mathbb{R}$, the functional A_h is bounded below on the hyperplane $H_{T,\xi}^1 = \{y \in H_T^1: \bar{y} = \xi\}$. Consequently, by the argument of Theorem 2, it reaches its minimum on $H_{T,\xi}^1$ and we let

$$\varphi_h(\xi) := \min_{\bar{y}=\xi} A_h(y) = \min_{\tilde{y} \in \tilde{H}_T^1} A_h(\xi, \tilde{y}), \tag{28}$$

defining in this way the real function $\varphi_h : \mathbb{R} \rightarrow \mathbb{R}$, $\xi \mapsto \varphi_h(\xi)$. Define also

$$\begin{aligned} M_h(\xi) &= \{y \in H_T^1: \bar{y} = \xi, A_h(y) = \varphi_h(\bar{y})\} \\ &= \left\{y \in H_T^1: \bar{y} = \xi, A_h(\xi, \tilde{y}) = \min_{\tilde{z} \in \tilde{H}_T^1} A_h(\xi, \tilde{z})\right\} \end{aligned}$$

(the set of y in the hyperplane $\bar{y} = \xi$ where A_h reaches its minimum on this hyperplane),

$$\begin{aligned} M_h &= \bigcup_{\xi \in \mathbb{R}} M_h(\xi) = \{y \in H_T^1: A_h(y) = \varphi_h(\bar{y})\} \\ &= \left\{y \in H_T^1: A_h(\bar{y}, \tilde{y}) = \min_{\tilde{z} \in \tilde{H}_T^1} A_h(\bar{y}, \tilde{z})\right\}. \end{aligned}$$

THEOREM 4. *The following properties hold for φ_h .*

1. φ_h is locally Lipschitz continuous on \mathbb{R} .
2. $M_h(\xi) \neq \emptyset$ and compact for each $\xi \in \mathbb{R}$, M_h is weakly closed and $M_h : \mathbb{R} \rightarrow 2^{H_T^1}$ is upper semi-continuous.
3. If $y \in M_h$ and \bar{y} gives a local minimum to φ_h , y gives a local minimum to A_h .
4. φ_h is differentiable at ξ if and only if $y \mapsto \int_0^T (a \sin y(t) - h(t)) dt$ is constant on $M_h(\xi)$.
5. If φ_h has a critical point, A_h has a critical point.
6. If φ_h is not strictly monotone, A_h has a critical point.

Properties 1, 2 and 3 are easy to prove, and Property 5 is a consequence of Property 4. To prove this last one, define

$$\lambda(\xi, \tilde{y}) = \frac{\partial}{\partial \xi} A_h(\xi, \tilde{y}) = \int_0^T \{a \cos[\xi + \tilde{y}(s)] + h(s)\} ds,$$

and show, using the following inequalities, valid when $A_h(\xi, \tilde{y}) = \varphi_h(\xi)$,

$$\varphi_h(\xi + \delta) - \varphi_h(\xi) \leq A_h(\xi + \delta, \tilde{y}) - A_h(\xi, \tilde{y})$$

and the mean value theorem, that if φ_h is differentiable at ξ , then

$$\varphi'_h(\xi) \leq \lambda(\xi + \tilde{y}) \leq \varphi'_h(\xi).$$

The proof of the converse is a little more elaborate and uses the compactness property in Property 2 and the uniform coercivity of $A_h(\xi, \cdot)$ on bounded sets. Finally, the proof of Property 6 uses, at a local maximum of φ_h , an argument on upper and lower solutions similar to the one used in Theorem 1.

It is interesting to compare this approach to the classical method of Lyapunov–Schmidt. In this case, one proves that, for each $\xi \in \mathbb{R}$, the set

$$K_h(\xi) = \{y \in C_T: \bar{y} = \xi, \tilde{y} \text{ solves Equation (18)}\}$$

is not empty, and then the problem is reduced to find the elements of the set $K_h = \bigcup_{\xi \in \mathbb{R}} K_h(\xi)$ such that

$$\overline{a \sin(\bar{y} + \tilde{y})} = \bar{h}.$$

In the Serra–Tarallo’s approach, on each slice $\xi + \tilde{H}_T^1$ of H_T^1 , one considers only the elements of $K_h(\xi)$ which minimize the restriction of A_h on this slice, which provides the subset $M_h(\xi) \subset K_h(\xi)$, and then, instead of trying to solve Equation (19) on this set, one concentrates on the reduced functional φ_h and relates its critical points to those of A_h . Hence the spirit is more variational than in earlier approaches combining a Lyapunov–Schmidt argument with some variational method (like Castro–Lazer’s one used in [32]), in that the emphasis, at each step, remains on the functional instead of on its gradient. One of the main features of this approach is that, in contrast to most other ones, it still works when $a \sin y$ is replaced by a more general *almost periodic* function.

3.4. The dissipative case $c > 0$

We just have shown that $0 \in [m_{\tilde{h}}, M_{\tilde{h}}]$ when $c = 0$. A natural question is to find an explicit element in $[m_{\tilde{h}}, M_{\tilde{h}}]$ when $c > 0$. The following result, proved in [85] by topological degree arguments, shows that $m_{\tilde{h}} < M_{\tilde{h}}$ and $0 \in]m_{\tilde{h}}, M_{\tilde{h}}[$ when c is sufficiently large.

THEOREM 5. *If $\frac{c}{T} > \frac{1}{\pi\sqrt{3}} \|\tilde{h}\|_2$, then $m_{\tilde{h}} < 0 < M_{\tilde{h}}$.*

The question was then raised to know if $0 \in [m_{\tilde{h}}, M_{\tilde{h}}]$ for each $c > 0$. A *negative answer* was first given by a counterexample of Ortega [99], and this result was improved by Alonso [2] in the following form.

THEOREM 6. *For each $c > 0$, there exists $\tilde{h} \in \tilde{C}_T$ and $T_0 = T_0(a, c)$ such that for each $T > T_0$, $0 \notin [m_{\tilde{h}}, M_{\tilde{h}}]$.*

The idea of Alonso’s result consists in constructing a forcing term close to a piecewise constant function $h(t)$ taking a large positive value p in the interval $[0, \tau]$ and a small negative value $-q$ in the interval $[\tau, T]$, where $p\tau - q(T - \tau) = 0$.

Further information has been given by Ortega, Serra and Tarallo [107] who have proved the following interesting result. Let \tilde{H} be defined in Lemma 1 and $\mathcal{B}_T \in L^2_T$ be the T -periodic function defined by

$$\mathcal{B}_T(t) = 2\pi \left(\frac{t}{T} - \left[\frac{t}{T} \right] \right) - \pi. \tag{29}$$

THEOREM 7. *Given $a > 0$, $c > 0$ and $T > 0$, there exists $\varepsilon > 0$ such that Equation (14) has no T -periodic solution if $h \in \tilde{L}^1_T$ and*

$$\|\tilde{H} - \mathcal{B}_T\|_2 < \varepsilon.$$

Moreover, ε can be explicitly computed in terms of a , c and T .

To prove this result, the authors first consider the equivalent formulation (16) of Equation (14) which, for $\tilde{H} = \mathcal{B}_T$ is itself equivalent to equation

$$y'' + cy' - a \sin(y + \omega t) = 0. \tag{30}$$

Multiplying both members of Equation (30) by $y' + \omega$ and integrating over $[0, T]$ shows immediately that Equation (30) has no T -periodic solution. This is in contrast with the case where $c = 0$, for which Bates [9] has shown the existence of a continuum of T -periodic solutions (see also [86]). The following lemma provides estimates for the possible T -periodic solutions of equation

$$y'' + cy' - a \sin(y + \omega t + P(t)) = 0, \tag{31}$$

where $P \in L^2_T$.

LEMMA 7. *Let y be a possible T -periodic solution of Equation (31). Then*

$$\|y'\|_2^2 \leq \varphi \left(\frac{a}{c} \|P\|_2 \right),$$

where

$$\varphi(s) = \frac{1}{2} \left(s^2 + \sqrt{s^4 + \frac{16\pi^2}{T} s^2} \right),$$

and

$$\|y'\|_2^2 \geq \frac{Ta^2}{2(\omega^2 + c^2)} - 2 \frac{\sqrt{T}a^2}{\omega^2 + c^2} \left(\frac{1}{\omega^2} \varphi \left(\frac{a}{c} \|P\|_2 \right) + \|P\|_2^2 \right)^{1/2}.$$

The first inequality is obtained by subtracting and adding $a \sin(y + \omega t)$ to Equation (31), multiplying both members by $y' + \omega$, integrating over $[0, T]$ and using T -periodicity and Cauchy–Schwarz inequality. For the second inequality, one first observes that the right-hand side of the equivalent form of Equation (31)

$$y'' + cy' - a \sin(\bar{y} + \omega t) = -a \sin(\bar{y} + \omega t) + a \sin(y + \omega t + P(t)) := f(t)$$

has mean value zero if y solves (31) and we call \tilde{F} the solution of Equation (15) with right-hand side $f(t)$. Setting $z = y - \tilde{F}$, we obtain the equivalent equation

$$z'' + cz' - a \sin(\bar{y} + \omega t) = 0,$$

with solution

$$z(t) = -\frac{a}{\omega^2 + c^2} \sin(\bar{y} + \omega t) - \frac{ac}{\omega(\omega^2 + c^2)} \cos(\bar{y} + \omega t)$$

such that

$$\|z'\|_2^2 = \frac{Ta^2}{2(\omega^2 + c^2)}.$$

Then

$$\|y'\|_2^2 \geq \frac{Ta^2}{2(\omega^2 + c^2)} - \sqrt{\frac{2Ta^2}{\omega^2 + c^2}} \|F'\|_2 \geq \frac{Ta^2}{2(\omega^2 + c^2)} - \sqrt{\frac{2Ta^2}{\omega^2 + c^2}} \frac{\|f\|_2}{\omega^2 + c^2}.$$

The result then follows from

$$|f(t)| \leq a(|\bar{y}(t)| + |P(t)|)$$

and the use of Wirtinger’s inequality.

To deduce Theorem 7 from Lemma 7, it suffices to observe that if

$$\begin{aligned} & \frac{Ta^2}{2(\omega^2 + c^2)} \varphi\left(\frac{a}{c} \|P\|_2\right) + 2 \frac{\sqrt{Ta^2}}{\omega^2 + c^2} \left(\frac{1}{\omega^2} \varphi\left(\frac{a}{c} \|P\|_2\right) + \|P\|_2^2\right)^{1/2} \\ & < \frac{Ta^2}{2(\omega^2 + c^2)}, \end{aligned}$$

then Equation (31) has no T -periodic solution, and, since $\varphi(s) \rightarrow 0$ as $s \rightarrow 0$, this happens when $\|P\|_2$ is sufficiently small.

A consequence of Theorem 7 is that, under its conditions, every solution y of Equation (14) is such that $\lim_{t \rightarrow +\infty} |y(t)| = \infty$. This follows from the fact that the *Poincaré mapping*

$$\mathcal{P} : (y(0), y'(0)) \rightarrow (y(T), y'(T)) \tag{32}$$

associated to an arbitrary solution y of Equation (14) is an orientation preserving homeomorphism of the plane, whose fixed points are the T -periodic solutions of Equation (14). As \mathcal{P} has no fixed point under the conditions of Theorem 7, the theory of Brouwer for fixed point free homeomorphisms [53] is applicable, and the orbits of \mathcal{P} must go to infinity. The result then follows from the easily verified fact that the derivatives of the solutions of Equation (14) are bounded.

3.5. The degeneracy problem

The *degeneracy problem* for the T -periodic solutions of Equation (14), which is still open, consists in proving or disproving the existence of some h such that $m_{\bar{h}} = M_{\bar{h}}$. Here is the known partial information.

We start with some results valid for $c \geq 0$.

THEOREM 8. *For the T -periodic problem for Equation (14), the set $\{\bar{h} \in \tilde{\mathcal{C}}_T : m_{\bar{h}} < M_{\bar{h}}\}$ is open and dense.*

This has been proved using various arguments [85,76,68], and in particular a *generalized Sard–Smale’s theorem*. Thus, *generically*, $[m_{\bar{h}}, M_{\bar{h}}]$ is a nondegenerate interval.

We now describe some contributions of Ortega and Tarallo [108], which generalize in various directions earlier results of Donati [41] and of Serra, Tarallo and Terracini [121].

DEFINITION 7. Equation (14) is said to be *degenerate* if the set of \bar{h} such that Equation (14) has a T -periodic solution is a singleton $\{\bar{h}_{\bar{h}}\}$, i.e., if $m_{\bar{h}} = M_{\bar{h}}$.

In the (excluded) case where $a = 0$, Equation (14) is degenerate. It only admits T -periodic solutions when $\bar{h} = 0$, in which case it has an unbounded path of T -periodic solutions. This fact will be extended to the case where $a > 0$. Let \mathcal{T} be the set of T -periodic solutions of Equation (14). Using the Lyapunov–Schmidt decomposition and the Leray–Schauder argument of the proof of Theorem 1, we obtain the existence of a connected and closed subset $\mathcal{C} \subset \mathcal{T}$ such that $\{y(0) : y \in \mathcal{C}\} = \mathbb{R}$. By the same argument, one indeed proves that given a closed interval $I \subset \mathbb{R}$ and $\tau \in \mathbb{R}$, a closed connected set $\mathcal{C}_{\tau,I} \subset \mathcal{T}$ exists such that $\{y(\tau) : y \in \mathcal{C}_{\tau,I}\} = I$.

THEOREM 9. *The following statements for Equation (14) are equivalent.*

- (i) *The equation is degenerate.*
- (ii) *For any $\xi \in \mathbb{R}$, there exists a unique $y_\xi \in \mathcal{T}$ which satisfies $y_\xi(0) = \xi$.*
- (iii) *There exists a continuous path $\xi \mapsto y_\xi$ in \mathcal{T} which satisfies*

$$\lim_{\xi \rightarrow \pm\infty} y_\xi(t) = \pm\infty$$

uniformly in $t \in \mathbb{R}$.

Moreover, if one of those conditions holds, the map $\xi \mapsto y_\xi$ is continuous, monotone ($y_\xi(t) < y_\eta(t)$ for all $t \in \mathbb{R}$ when $\xi < \eta$), and such that $y_{\xi+2\pi} = y_\xi + 2\pi$.

To show that condition (i) implies condition (ii), one first observes that if two elements $y, z \in \mathcal{T}$ intersect at some t_0 then they coincide or intersect transversally ($y'(t_0) \neq z'(t_0)$). This implies the following useful intermediate proposition.

PROPOSITION 4. *If $\mathcal{A} \subset \mathcal{T}$ be connected and $z \in \mathcal{T} \setminus \mathcal{A}$, and if, for some $y^* \in \mathcal{A}$, z and y^* do not intersect, then z does not intersect any $y \in \mathcal{A}$.*

Indeed, $\{y \in \mathcal{A}: y \text{ does not intersect } v\}$ is trivially open, and $\{y \in \mathcal{A}: y \text{ intersects } v\}$ is open by the transversality property.

Coming back to the proof of Theorem 9, one then shows that, for any ξ and τ , letting $\mathcal{C}_{\tau, \xi} = \mathcal{C}_{\tau,]-\infty, \xi]}$, one has $\mathcal{C}_{\tau, \xi} = \mathcal{T}_{\tau, \xi} := \{y \in \mathcal{T}: y(\tau) \leq \xi\}$. This depends in particular on the property

$$\|y\|_\infty \leq |y(\tau)| + C, \tag{33}$$

satisfied by any T -periodic solution of Equation (14). One next proves using again Proposition 4 that given $y, z \in \mathcal{T}$ and $\tau \in \mathbb{R}$ such that $y(\tau) < z(\tau)$, one has $y(t) < z(t)$ for all $t \in \mathbb{R}$. This follows from the fact that, for $\xi = y(\tau)$, $z \notin \mathcal{T}_{\tau, \xi}$ and cannot intersect the very large functions in $\mathcal{T}_{\tau, \xi}$. Then the existence of y_ξ follows from the existence of \mathcal{C} and its uniqueness from the above monotonicity property.

To show that condition (ii) implies condition (iii), one uses (33), the uniqueness property and the local compactness of \mathcal{T} . By uniqueness also $y_{\xi+2\pi} = y_\xi + 2\pi$ and this implies the limiting properties of y_ξ for $\xi \rightarrow \pm\infty$. Finally, to prove that (iii) implies (i), assume that y is a T -periodic solution of Equation (14) and define

$$A = \{\xi \in \mathbb{R}: \forall t \in \mathbb{R}, y_\xi(t) \leq y(t)\}, \quad B = \{\xi \in \mathbb{R}: \forall t \in \mathbb{R}, y_\xi \geq y(t)\},$$

and $\xi_A = \max A$, $\xi_B = \min B$. One has $y_{\xi_A} \leq y$, $y_{\xi_B} \geq y$ and they must touch somewhere, namely at t_A and t_B , so that

$$y'_{\xi_A}(t_A) = y'(t_A), \quad y''_{\xi_A}(t_A) \leq y''(t_A),$$

and the reverse inequality for y_{ξ_B} at t_B . Then,

$$\begin{aligned} \bar{h}_h &= y''_{\xi_A}(t_A) + cy'_{\xi_A}(t_A) + a \sin y_{\xi_A}(t_A) - \tilde{h}(t_A) \\ &\leq y''(t_A) + cy'(t_A) + a \sin y(t_A) - \tilde{h}(t_A) = \bar{h} \\ &= y''_{\xi_B}(t_B) + cy'_{\xi_B}(t_B) + a \sin y_{\xi_B}(t_B) - \tilde{h}(t_B) \\ &\leq y''_{\xi_B}(t_B) + cy'_{\xi_B}(t_B) + a \sin y_{\xi_B}(t_B) - \tilde{h}(t_B) = \bar{h}_h, \end{aligned}$$

so that $\bar{h} = \bar{h}_h$.

Consequences of Theorem 9 are that the solutions bounded over \mathbb{R} of a degenerate equation are either T -periodic solutions, or heteroclinic connections between different T -periodic solutions, and some information about the stability of the T -periodic solutions.

We now describe some results valid in the conservative case $c = 0$, with, first, an improvement of Theorem 8 proved in [68] using a generalized Sard–Smale lemma.

DEFINITION 8. A *regular value* for a mapping f of class C^1 between two smooth Banach manifolds is the image by f of a point c such that f'_c is onto.

THEOREM 10. *The set \mathcal{G} of regular values for $y \rightarrow y'' + a \sin y$ on C_T^2 is open and dense in \tilde{C}_T , and, for every $g \in \mathcal{G}$, there exists $\varepsilon > 0$ such that, if $\|h - g\|_\infty \leq \varepsilon$, Equation (23) has a T -periodic solution.*

Serra, Tarallo and Terracini [121] have found another characterization of degeneracy in the conservative case. If $h \in \tilde{C}_T$, let

$$c_0 = \min_{H_T^1} A_h, \tag{34}$$

and for $\xi \in \mathbb{R}$, let

$$\mathcal{K}_{c_0}(\xi) := \{y \in H_T^1 : A_h(y) = c_0, \bar{y} = \xi\}.$$

PROPOSITION 5. *If $\mathcal{K}_{c_0}(\xi) \neq \emptyset$ for each $\xi \in \mathbb{R}$, then*

- (i) *For each $\xi \in \mathbb{R}$, $\mathcal{K}_{c_0}(\xi) = \{y_\xi\}$.*
- (ii) *The map $\xi \mapsto y_\xi$ is continuous and $y_\xi(t) < y_\eta(t)$ for all t if $\xi < \eta$.*
- (iii) *There are no other periodic solutions (of any period) to (23).*

To prove (i) one supposes that \mathcal{K}_{c_0} contains two points v and w . As $\overline{v - w} = 0$, one has $v(\tau) = w(\tau)$ for some τ and we show that $v'(\tau) = w'(\tau)$. Indeed, $y = \max(v, w) \in H_T^1$ and it is easy to show that $A_h(y) = c_0$, so that y solves Equation (23), thus is differentiable at τ , and the result follows. The second part of (ii) is proved in an analogous way and the first one easily follows from the fact that if $\xi_n \rightarrow \xi$, then (y_{ξ_n}) is a bounded Palais–Smale sequence, and hence is relatively compact. To show (iii) one first assume that u is a periodic solution of Equation (23) with period rational with T , and one defines

$$B = \{\xi \in \mathbb{R} : \forall t \in \mathbb{R}, y_\xi(t) \geq u(t)\}.$$

Like in Ortega–Tarallo reasoning above, B is nonempty, bounded below and closed, and one shows that, if $\xi_0 = \inf B$, then $u = y_{\xi_0}$. If $y_{\xi_0}(t) > u(t)$ for all $t \in \mathbb{R}$, then the rationality of the period of u with T implies that $\varepsilon := \inf_{t \in \mathbb{R}} [y_{\xi_0}(t) - u(t)] > 0$. For $\delta > 0$ such that $|\xi - \xi_0| \leq \delta$ implies $\|y_\xi - y_{\xi_0}\|_\infty \leq \varepsilon$, we see that $\xi_0 - \delta \in B$, a contradiction with the definition of ξ_0 . Thus $y_\xi(t_0) = u(t_0)$ for some t_0 and then also $y'_\xi(t_0) = u'(t_0)$, so that $y_\xi = u$. If the period of u is irrational with T , then $h \equiv 0$ is constant and the assumption is not satisfied.

THEOREM 11. *Let $h \in C_T$ and $c_0 = \min_{H_T^1} A_h$. Then $m_{\bar{h}} < M_{\bar{h}}$ if and only if*

$$\mathcal{K}_{c_0}(\xi) = \emptyset \quad \text{for some } \xi \in \mathbb{R}. \tag{35}$$

In this case, 0 is an interior point of $[m_{\bar{h}}, M_{\bar{h}}]$.

If $\mathcal{K}_{c_0}(\xi) = \emptyset$, then one can find $\rho > 0$ and $\delta > 0$ such that if $\|\bar{y} - \xi\| \leq \rho$, and $|A_{\bar{h}}(y) - c_0| \leq \rho$, then $\|A'_{\bar{h}}(y)\| \geq \delta$. If not, for each positive integer n , there exist y_n such that

$$\|\bar{y}_n - \xi\| \leq \frac{1}{n}, \quad |A_{\bar{h}}(y_n) - c_0| \leq \frac{1}{n}, \quad \|A'_{\bar{h}}(y_n)\| \leq \frac{1}{n}.$$

The (BPS)-condition leads to a contradiction. Now let $z \in H_T^1$ be such that $A_{\bar{h}}(z) < c_0 + \delta$ and m, k be two integers such that $\xi + 2k\pi < \bar{z} < \xi + 2m\pi$. Let $B = \{y \in H_T^1: \xi + 2k\pi \leq \bar{y} \leq \xi + 2m\pi\}$. Since by construction and its 2π -periodicity $A_{\bar{h}}(z) < c_0 + \delta \leq \min_{\partial B} A_{\bar{h}}$, we have $A_h(z) < \min_{\partial B} A_h$ provided $\bar{h} \in [-\mu, \mu]$, for some sufficiently small $\mu > 0$. Taking a minimizing sequence (y_n) for A_h restricted to B , which, up to a subsequence, weakly converges to y , we obtain $A_h(y) = \min_B A_h$, and, from $A_h(y) \leq A_h(z) < \min_{\partial B} A_h$, y is a local minimum for A_h on H_T^1 and hence a solution to Equation (23). The proof of the converse result is essentially the same as the proof of the implication (iii) \Rightarrow (i) in Theorem 9.

Serra and Tarallo [119] have used their reduction method to obtain more precise information.

THEOREM 12. *Let $h \in C_T$.*

1. *If φ_h is constant, then $M_h(\xi) = \{y_\xi\}$, and if y is a periodic solution of Equation (23), then $\bar{h} = 0$ and $y = y_\xi$ for some $\xi \in \mathbb{R}$.*
2. *φ_h is not constant if and only if there exists $\varepsilon_0 > 0$ such that Equation (23) has at least one T -periodic solution for each $|\bar{h}| < \varepsilon_0$.*
3. *$[m_{\bar{h}}, M_{\bar{h}}] = \{0\}$ if and only if φ_h is constant.*
4. *$\{\bar{h} \in \tilde{C}_T: \varphi_{\bar{h}} \text{ is not constant}\}$ is open and dense in \tilde{C}_T .*
5. *If φ_h is constant and $\bar{h} \neq 0$, then Equation (23) has no bounded solution.*

From the study of some dynamical properties of diffeomorphisms of the plane having a continuum of fixed points, Campos, Dancer and Ortega [27] have refined conclusion (iii) of Proposition 5.

THEOREM 13. *If (23) is degenerate, then every solution which is bounded in the future is a T -periodic solution.*

The corresponding diffeomorphism of the plane is of course Poincaré’s map.

Finally, Kannan and Ortega [61] have proved the following asymptotic result, showing that $M_{\bar{h}} - m_{\bar{h}}$ can be small, and have given an example showing that the involved set is not open. The proof makes use of some Riemann–Lebesgue lemma and asymptotic analysis techniques.

THEOREM 14. *For $c = 0$,*

$$\left\{ \bar{h} \in \tilde{C}_T: \lim_{|\lambda| \rightarrow \infty} m_{\lambda\bar{h}} = \lim_{|\lambda| \rightarrow \infty} M_{\lambda\bar{h}} = 0 \right\}$$

contains an open and dense subset of \tilde{C}_T .

3.6. Multiplicity and stability results under restrictions of the coefficients

More precise results in the conservative case $c = 0$ can be obtained if one assumes that condition

$$a < \omega^2 \tag{36}$$

holds. Donati [41] has proved the following result about the structure of the solution set.

THEOREM 15. *If condition (36) holds and $\bar{h} \in [m_{\bar{h}}, M_{\bar{h}}]$, then Equation (23) has at most finitely many distinct T -periodic solutions when $[m_{\bar{h}}, M_{\bar{h}}] \neq \{0\}$. Otherwise, Equation (23) has an analytic unbounded curve of solutions.*

Starting from the Lyapunov–Schmidt’s reduction, one first proves that for each $\bar{y} \in \mathbb{R}$ and $\tilde{h} \in \tilde{C}_T$, Equation (18) has a unique solution $\tilde{y} = \tilde{y}(\bar{y}, \tilde{h}) \in \tilde{C}_T^2$, which depends analytically upon \bar{y} and \tilde{h} , and is such that

$$\|\tilde{y}\|_{C^2} \leq C(|\bar{y}| + \|\tilde{h}\|_\infty)$$

for a suitable constant $C > 0$. The problem is reduced to the study of the real valued function \mathcal{F} defined over $\mathbb{R} \times \tilde{C}_T$ by

$$\mathcal{F}(\bar{y}, \tilde{h}) := \frac{1}{T} \int_0^T a \sin[\bar{y} + \tilde{y}(\bar{y}, \tilde{h})] dt.$$

One shows that, for each fixed $\tilde{h} \in \tilde{C}_T$, $\mathcal{F}(\cdot, \tilde{h})$ is a real analytic 2π -periodic function and that

$$m_{\bar{h}} = \min_{\bar{y} \in [0, 2\pi]} \mathcal{F}(\bar{y}, \tilde{h}) \leq 0 \leq M_{\bar{h}} = \max_{\bar{y} \in [0, 2\pi]} \mathcal{F}(\bar{y}, \tilde{h}).$$

The result follows from properties of analytical functions.

By imposing further restrictions upon c , a , and T , it is possible to obtain on one hand *exact multiplicity results* for the T -periodic solutions, and, on the other hand, informations upon their *Lyapunov stability*. The pioneering work in the first direction is due to Tarantello [123] (using a Lyapunov–Schmidt approach) and, in the second direction, to Ortega [100–102] (using relations between stability and the Brouwer degree of Poincaré’s operator).

If we first assume that $c > 0$, a recent paper of Čepička, Drábek and Jenšíková [33] provides the sharpest known conditions.

THEOREM 16. *If*

$$c > 0, \quad a < \max \left\{ \frac{c^2}{4} + \omega^2, \omega\sqrt{c^2 + \omega^2} \right\},$$

then $m_{\bar{h}} < M_{\bar{h}}$ and Equation (14) has:

- (1) exactly one T -periodic solution if either $\bar{h} = m_{\bar{h}}$ or $\bar{h} = M_{\bar{h}}$;
- (2) exactly two T -periodic solutions if $\bar{h} \in]m_{\bar{h}}, M_{\bar{h}}[$.

If

$$c > 0, \quad a < \max \left\{ \frac{c^2 + \omega^2}{4}, \frac{\omega}{2} \sqrt{c^2 + \frac{\omega^2}{4}} \right\},$$

then the conclusions 1 and 2 remain true and the periodic solution obtained in case 1 is unstable while one solution obtained in case 2 is asymptotically stable and the other one unstable.

The proof of the exact multiplicity results in Theorem 16 is based upon the Lyapunov–Schmidt reduction method together with the real analytic version of the implicit function theorem, to analyze the bifurcation equation. The uniqueness in the solution of Equation (18) is deduced from some preliminary study of the T -periodic solutions of linear equations of the type

$$y'' + cy' + g(t)y = 0,$$

with g T -periodic. The stability conclusion is obtained in the same way as in Ortega’s papers.

Assume now that $c = 0$. The difficulty in analyzing the stability in the conservative case is that asymptotic stability can no more be expected. In a recent paper, Dancer and Ortega [37] have proved the following proposition.

LEMMA 8. *A stable isolated fixed point of an orientation preserving local homeomorphism on \mathbb{R}^2 has fixed point index equal to one.*

The proof of this result depends upon a variant of Brouwer’s lemma on translation arcs. One of the given applications is the following result. Let $V : \mathbb{R}^2 \rightarrow \mathbb{R}$, $(t, y) \mapsto V(t, y)$ be continuous together with $\frac{\partial V}{\partial y}$, and T -periodic in t .

LEMMA 9. *If y is an isolated T -periodic solution of equation*

$$y'' = \frac{\partial V}{\partial y}(t, y), \tag{37}$$

and y reaches a local minimum on H_T^1 of the action functional

$$\varphi(y) = \int_0^T \left(\frac{y'^2(t)}{2} + V(t, y(t)) \right) dt,$$

then y is unstable.

This result is proved by showing first, through a result of Amann on the computation of degree of gradient mappings and a relatedness principle of Krasnosel'skii–Zabreiko, that the index of y is equal to minus one. The result then follows from the previous one.

An immediate consequence for the pendulum equation is the following one.

THEOREM 17. *If $h \in \tilde{C}_T$, any isolated T -periodic solution of Equation (23) minimizing A_h is unstable.*

One can then ask if the above result still holds without the isolatedness assumption. Ortega [105] has proved the following interesting property of fixed points in the plane.

LEMMA 10. *If $D \subset \mathbb{R}$ is a domain and $F : D \subset \mathbb{R}^2 \rightarrow \mathbb{R}^2$ is real analytical and not the identity on D , its Jacobian is equal to 1 on D , and if p is a stable fixed point of F , then p is isolated in the fixed points set of F .*

The delicate proof of this result uses Brouwer's plane translation theorem.

As an application, the following unstability result is proved in [105].

LEMMA 11. *If V is real analytic, and y is a T -periodic solution of Equation (37) on which φ has a local minimum on H_T^1 , then y is unstable.*

An immediate consequence for the forced pendulum equation is the following one.

THEOREM 18. *If $h \in \tilde{C}_T$ is analytical, the number of T -periodic solutions of Equation (23) that are stable and geometrically distinct is finite.*

Calanchi and Tarallo [26] have used the Serra–Tarallo reduction method to show the following result.

THEOREM 19. *Assume that $a < \omega^2$. Then there exists $K = K(a, T) > 0$ such that if $\|h\|_2 < K$, there exists an increasing and continuous map $\eta : \mathbb{R} \rightarrow \mathbb{R}$ such that, for the reduction function φ_h , one has*

$$\#\varphi_h^{-1}(\lambda) = \#[aT \cos(\cdot)]^{-1}(\eta(\lambda)).$$

Furthermore, each critical point of A_h over H_T^1 is a local minimum or a point of mountain pass type.

3.7. Many T -periodic solutions for special forcings

We now raise the question of the possibility of having more than two geometrically distinct T -periodic solutions for the forced pendulum. In [40], Donati proved the following result.

THEOREM 20. *Given $a > 0$ and $T > 0$, there exists $h^* \in \tilde{C}_T$ and a neighborhood V of h^* in \tilde{C}_T such that for each $h \in V$, Equation (23) has at least four geometrically distinct T -periodic solutions.*

The proof is based upon a *classification of singularities* of the nonlinear Fredholm operator $\frac{d^2}{dt^2} + a \sin(\cdot)$ over the space of C^2 T -periodic functions.

Applying to Equation (16) a classical *perturbation method* as used for example by Loud for Duffing's equation, Ortega [104] has improved this result by replacing 4 by any even number.

THEOREM 21. *Given $a > 0$ and an integer $N \geq 1$, there exists $h^* \in \tilde{C}_T$ and $\delta > 0$ such that if $h \in \tilde{C}_T$ is such that $\|h - h^*\|_{L^1} < \delta$, then Equation (23) has at least $2N$ geometrically distinct T -periodic solutions.*

The idea of the proof consists in considering the equation

$$y'' + a \sin(y + \mathcal{B}_T(t)) = 0, \tag{38}$$

where \mathcal{B}_T is defined in (29), which has a continuum $(y_c)_{c \in \mathbb{R}}$ of T -periodic solutions, and in considering a perturbation of Equation (38)

$$y'' + a \sin(y + \mathcal{B}_T(t) + \Psi(t, \varepsilon)) = 0, \tag{39}$$

with conditions upon Ψ insuring that $\mathcal{B}_T(t) + \Psi(t, \varepsilon)$ is smooth and that one has at least $2N$ periodic simultaneous bifurcations for $\varepsilon = 0$.

We finally describe some recent results obtained by Ureña [127], which cover the possibly dissipative case.

THEOREM 22. *For any $N \in \mathbb{N}$, the set*

$$\mathcal{S}_N := \{h \in L^1_T: (14) \text{ has at least } N \text{ geometrically distinct solutions}\}$$

has nonempty interior in L^1_T . More precisely,

- (1) $\text{int } \mathcal{S}_N \cap \tilde{L}^1_T \neq \emptyset$ if $c = 0$;
- (2) $\text{int } \mathcal{S}_N \cap \{h \in L^1_T: -\varepsilon < \bar{h} < 0\} \neq \emptyset \neq \text{int } \mathcal{S}_N \cap \{h \in L^1_T: 0 < \bar{h} < \varepsilon\}$ if $c \neq 0$.

The proof uses the equivalent formulation (16). One first observes that there exists a necessarily constant \bar{h} such that the problem

$$y'' + cy' + a \sin y = \bar{h}, \quad y(0) = 0, \quad y(t + T) = y(t) + 2\pi$$

has a unique solution, denoted by $y_{c,T}$. This is proved by considering the equivalent problem of finding $w \in C_T$ solution of equation

$$v'' + cv' + a \sin(v + \omega t) = \bar{h} - \omega c,$$

and using Schauder’s fixed point theorem to obtain $\bar{h} = \bar{h}_{c,T}$ for which a solution $v_{c,T}$ exists. Notice that such a problem is degenerate, and hence has a nontrivial curve of solutions $\gamma : \mathbb{R} \rightarrow C_T^1, a \mapsto v_{c,T}(\cdot + a) + \omega a$. Some bifurcation technique based upon Lyapunov–Schmidt decomposition is then used to obtain many solutions bifurcating from such a closed loop at a constant external force. See [127] for the quite involved details, as well as for the proof of the following result, when $c = 0$.

THEOREM 23. *Let $N \in \mathbb{N}$ be given. If $c = 0$ and*

$$T \geq 12 \log\left(\frac{\sqrt{3} + 1}{\sqrt{2}}\right) \frac{N}{\sqrt{a}},$$

there exists an open set $\mathcal{O}_N \subset L_T^1$ with $\mathcal{O}_N \cap \tilde{L}_T^1 \neq \emptyset$, such that, for any $h \in \mathcal{O}_N$, Equation (23) has exactly $2N$ geometrically distinct T -periodic solutions.

3.8. Many T -periodic solutions for small length pendulum

To motivate a further multiplicity result of perturbation type proved by Fonda and Zanolin [46] in the forced case, let us recall that for the conservative free pendulum equation (23), relation (7) implies that, given any positive integer N , Equation (5) has a closed orbit with least period $\frac{T}{k}$ for each $k = 1, 2, \dots, N$, if $a > \frac{4\pi^2 N^2}{T^2}$. To deal with the forced case, Fonda and Zanolin use Weiyue Ding’s generalization of the Poincaré–Birkhoff fixed point theorem [39] for the area-preserving twist homeomorphism given by Poincaré’s operator \mathcal{P} , that we recall now.

Let A be the annulus $S^1 \times [a, b]$ in \mathbb{R}^2 . If $\phi : A \rightarrow \mathbb{R}^2 \setminus \{0\}$, we denote by

$$F(\theta, r) : \mathbb{R} \times [a, b] \rightarrow \mathbb{R} \times [0, +\infty[, (\theta, r) \mapsto (\theta + f(\theta, r), g(\theta, r)) \tag{40}$$

its lift on the polar coordinates covering space, where f and g are 2π -periodic in θ .

The eldest fixed-point theorem for maps in an annulus is the *Poincaré–Birkhoff’s theorem* [112,15].

LEMMA 12. *Every area-preserving homeomorphism $\phi : A \rightarrow A$ which rotates the two boundaries in opposite directions, i.e., is such that $f(\theta, a)f(\theta, b) < 0$ for all $\theta \in \mathbb{R}$, has at least two fixed points in the interior of A .*

A more effective version for applications has been given by Weiyue Ding [39].

LEMMA 13. *Let $A \subset \mathbb{R}^2 \setminus \{0\}$ denote an annular region whose inner boundary Γ_1 and outer boundary Γ_2 are closed simple curves around the origin 0 and denote by D_i the open region bounded by $\Gamma_i, i = 1, 2$. Let $\varphi : A \rightarrow \mathbb{R}^2 \setminus \{0\}$ be an area-preserving homeomorphism. Suppose that*

- (i) the inner boundary curve Γ_1 is star-shaped around the origin,
- (ii) φ admits a lift F onto the polar coordinate covering space (40), such that $f(\theta, r) > 0$ on the lift of Γ_1 and $f(\theta, r) < 0$ on the lift of Γ_2 ,
- (iii) there exists an area-preserving homeomorphism $\varphi_0 : \overline{D}_2 \rightarrow \mathbb{R}^2$ which satisfies $\varphi_0|_A \equiv \varphi$ and $0 \in \varphi_0(D_1)$.

Then φ has at least two fixed points in the interior of A .

The result of Fonda and Zanolin can be stated as follows.

THEOREM 24. *Given any positive integer N , there exists $a_0 > 0$ such that, for any $a \geq a_0$, Equation (23) has at least N periodic solutions with minimal period T , which can be chosen to have exactly $2j$ simple crossings with 0 in the interval $[0, T[$ ($j = 1, 2, \dots, N$).*

To prove this result, the authors notice that a simple change of variable transforms Equation (23) into equation

$$y'' + \sin y = a^{-1}h(a^{-1/2}t) \tag{41}$$

and the T -periodic solutions of Equation (23) correspond to the $T\sqrt{a}$ -periodic solutions of Equation (41). They combine then a perturbation argument together with Ding’s twist theorem.

3.9. Subharmonic solutions when $c = 0$

Subharmonic solutions of a T -periodic equation are solutions whose minimal period is a proper multiple of T .

DEFINITION 9. If $k \geq 2$ is an integer, a *subharmonic solution* of order k of Equation (14) is a periodic solution of Equation (14) with minimal period kT .

The first existence theorem for the subharmonic solutions of Equation (23) with $h \in \tilde{C}_T$ have been obtained by Fonda and Willem [45] using Morse theory (see, e.g., [86]). Offin [96] has proved a close result using an index theory for periodic extremals and a variant of the mountain pass lemma. The subharmonics of order k are associated to the critical points of the functional $A_{h,k}$ defined by

$$A_{h,k}(y) = \int_0^{kT} \left(\frac{y'^2(t)}{2} + a \cos y(t) + h(t)y(t) \right) dt,$$

over the Sobolev space H_{kT}^1 .

DEFINITION 10. The *Morse index* of an isolated T -periodic solution y of Equation (23) is the supremum of the dimensions of the subspaces of H_T^1 on which the quadratic form

$$\chi_y(v) := \int_0^T (1/2)\{v'^2(t) - [a \cos y(t)]v^2(t)\} dt$$

is negative definite.

If, for $\lambda \in \mathbb{R}$, we denote by $\sigma'_{\lambda,T}$ and $\sigma''_{\lambda,T}$ the characteristic multipliers of the T -periodic differential equation

$$v'' + [a \cos y(t)]v + \lambda v = 0,$$

then y is said to be *nondegenerate* if $1 \notin \{\sigma'_{\lambda,T}, \sigma''_{\lambda,T}\}$. Given $\sigma \in S^1$, one defines $J(y, T, \sigma)$ to be the number of negative λ 's for which $\sigma \in \{\sigma'_{\lambda,T}, \sigma''_{\lambda,T}\}$. Then $J(y, T, 1)$ is equal to the Morse index of the T -periodic solution y of (23). *Bott's iteration formula* [24] ensures that

$$J(y, kT, 1) = \sum_{\sigma^k=1} J(y, T, \sigma).$$

THEOREM 25. *Suppose that the T -periodic solutions of Equation (23) are isolated and that every T -periodic solution of Equation (23) having Morse index equal to zero is nondegenerate. Then there exists $k_0 \geq 2$ such that, for every prime $k \geq k_0$, there is a periodic solution of Equation (23) with minimal period kT . If moreover the kT -periodic solutions of Equation (23) are nondegenerate for $k = 1$ and every prime k , there exists $k_0 \geq 3$ such that, for every prime $k \geq k_0$, Equation (23) has at least two periodic solutions with minimal period kT .*

By assumption and an easy reasoning, $A_{h,1} = A_h$ has a finite number of critical points y_0, y_1, \dots, y_n , which, of course, are also critical points of $A_{h,k}$ for any $k \geq 2$. The first ingredient of the proof consists in showing the existence of some integer k_0 such that, for $k \geq k_0$ and $0 \leq i \leq n$, either the Morse index $J(y_i, kT, 1)$ of y_i is equal to 0 and y_i is nondegenerate, or $J(y_i, kT, 1) \geq 2$. This is done using Bott's iteration formula. Now, let $k \geq k_0$ be prime, so that the critical points of $A_{h,k}$ have minimal period T or kT . Assume now by contradiction that y_0, \dots, y_n are the only critical points of $A_{h,k}$. The *Poincaré polynomial* of the space $S^1 \times \tilde{H}_T^1$ (whose coefficient of t^n is the n th Betti number of $S^1 \times \tilde{H}_T^1$) is equal to $1 + t$, and hence, by the *Morse inequalities* [86], one has

$$\sum_{j=0}^n M_k(t, y_j) = (1 + t)(1 + Q(t)) \tag{42}$$

for some polynomial $Q(t)$ with nonnegative integer coefficients. In this formula,

$$M_k(t, y_j) = \sum_i \dim C_i(A_{h,k}, y_j), \quad C_i(A_{h,k}, y_j)$$

is the i th critical group of y_j [86], so that $\dim C_i(A_{h,k}, y_j) = \delta_{i, J(y_j, kT, 1)}$ when y_j is nondegenerate. By the claim, if $J(y_j, kT, 1) = 0$, then $M_k(t, y_j) = 1$, and otherwise, if $J(y_j, kT, 1) \geq 0$, then $\dim C_i(A_{h,k}, y_j) = 0$ for $i = 0, 1$, and $M_k(t, y_j)$ starts with terms in t^2 at least. So, the left-hand member of (42) contains no term in t , a contradiction. The proof of the second part of Theorem 25 is similar.

Combining the Fonda–Willem’s theorem with the results of [68], one obtains the generic existence of subharmonic solutions.

THEOREM 26. *There exists an open dense subset \mathcal{G} of $\tilde{\mathcal{C}}_T$ such that for every $h \in \mathcal{G}$, there exists $k_0 \geq 2$ such that, for every prime $k \geq k_0$, Equation (23) has a periodic solution with minimal period kT .*

As shown in [121], the modified Lyapunov–Schmidt reduction method also provides some information about subharmonic solutions, by relating their existence to the properties of φ_h .

THEOREM 27. *Equation (23) with $h \in \tilde{\mathcal{C}}_T$ has subharmonics of infinitely many distinct levels if and only if φ_h is not constant. If $\min_{H_T^1} A_h$ is isolated in the set of critical levels of A_h , then Equation (23) with $h \in \tilde{\mathcal{C}}_T$ admits subharmonics of arbitrary large minimal period if and only if φ_h is not constant. Finally, the isolatedness assumption in the previous statement can be dropped if $a < \omega^2$.*

Fonda–Zanolin’s multiplicity result [46] has a counterpart for subharmonic solutions, proved using the same fixed point technique.

THEOREM 28. *Given any two positive integers M, N , there exists $a_0 > 0$ such that, for any $a \geq a_0$, Equation (23) has, for each $k = 1, 2, \dots, M$, at least N periodic solutions with minimal period kT .*

4. Rotating solutions and Mather sets

4.1. Periodic solutions of the second kind

Besides periodic solutions, we have seen the free pendulum has also periodic solutions of the second kind, which are the sum of a linear function of t and of a periodic term. We shall study the existence of such solutions for the forced conservative pendulum (23).

DEFINITION 11. y is a *periodic solution of the second kind* of (23) if there exists $p \in \mathbb{Z} \setminus \{0\}$ and $q \in \mathbb{N} \setminus \{0\}$ such that, for each $t \in \mathbb{R}$, one has

$$y(t + qT) = y(t) + 2p\pi. \tag{43}$$

Notice that such a solution is such that

$$y'(t + qT) = y'(t)$$

for all $t \in \mathbb{R}$, and hence, integrating and using (43), we find that

$$y(t) = \frac{p}{q}\omega t + v(t) \tag{44}$$

with $\omega = 2\pi/T$ and v some qT -periodic function. Conversely, every solution of (23) of the type (44) is a periodic solution of second kind. Such a solution has the *rotation number*

$$\lim_{t \rightarrow \pm\infty} \frac{y(t)}{\omega t} = \frac{p}{q}. \tag{45}$$

Under some conditions, the conservative forced pendulum (23) can also admit periodic solutions of the second kind. First, the change of unknown $y(t) \mapsto v(t)$ defined by (44) and the use of direct methods of the calculus of variations to the transformed equation allows a very simple proof of the following result [79].

THEOREM 29. *For each $a > 0$, $T > 0$, $q \in \mathbb{N} \setminus \{0\}$, $p \in \mathbb{Z} \setminus \{0\}$, and each $h \in \tilde{C}_T$, Equation (23) has at least one solution y satisfying (43).*

Such a solution, also called a *rotating solution of Equation (23) with rotation number $\frac{p}{q}$* , is entirely determined by its values on $[0, qT]$, and satisfies the boundary conditions

$$y(qT) = y(0) + 2p\pi, \quad y'(qT) = y'(0). \tag{46}$$

A second geometrically distinct solution also follows from the mountain pass argument.

In the case of an analytic h , Ortega’s approach described in Section 3.7 provides information about the number and stability of those rotating solutions [105].

THEOREM 30. *If $h \in \tilde{C}_T$ is analytic, given $p \in \mathbb{Z} \setminus \{0\}$ and $q \in \mathbb{N} \setminus \{0\}$, the number of stable and distinct rotating solutions with rotation number $\frac{p}{q}$ of Equation (23) is finite.*

4.2. Solutions with an arbitrary rotation number

We shall now show that Equation (23) with $h \in \tilde{C}_T$ also admits solutions having an arbitrary rotation number. This follows from some results of Mather [69] and Moser [89,88], that we sketch in the form given by Denzler [38], which is closer in spirit to the calculus of variations (see also [95]). Let $I = [t_1, t_2]$ be given and consider the action functional A_h^I defined on $H^1(I)$ by

$$A_h^I(y) = \int_I \left(\frac{y'^2(t)}{2} + a \cos y(t) + h(t)y(t) \right) dt. \tag{47}$$

DEFINITION 12. A function $y \in H^1(I)$ is called *minimal with respect to fixed boundary conditions on $I = [t_1, t_2]$* , if $A_h^I(z) \geq A_h^I(y)$ for all $z \in H^1(I)$ equal to y at t_1 and t_2 .

A function $y \in H^1_{\text{loc}}(\mathbb{R})$ is called a *minimal* if it is minimal with respect to fixed boundary conditions on every interval. Finally, a function $y \in H^1([0, qT])$ is *minimal with respect to condition (43)* if, for $I = [0, qT]$, $A^I_h(z) \geq A^I_h(y)$ for all $z \in H^1([0, qT])$ satisfying condition (46).

Notice that the direct method of the calculus of variations easily implies that, for $h \in \tilde{C}_T$, minimal solutions with respect to fixed boundary conditions on a given interval I always exist, are of class C^2 , and satisfy Equation (23). From Theorem 29, the same is true for the functions which are minimal with respect to condition (43). In particular those minimals have no corners, a fact which is useful in several proofs.

The existence of minimals is not clear from the direct methods of the calculus of variations, and will follow from a delicate sequence of arguments. We first give some properties of the minimals [38]. The first one deals with the possible intersections of two different minimals.

LEMMA 14. *Two different minimals can intersect at most once, and are not tangent to each other anywhere. Two different minimals which are C^1 asymptotic as $t \rightarrow \infty$ cannot intersect at all.*

The non-tangency is a consequence of the uniqueness of the Cauchy problem. The first intersection property is proved by contradiction, assuming that two minimals y and z intersect twice in the interior of some interval I , and noticing that if $y^* = \min(y, z)$, $z^* = \max(y, z)$, then

$$A^I_h(y^*) \geq A^I_h(y), \quad A^I_h(z^*) \geq A^I_h(z),$$

$$A^I_h(y^*) + A^I_h(z^*) = A^I_h(y) + A^I_h(z),$$

so that $A^I_h(y^*) = A^I_h(y)$, y^* is minimal and hence y and z must intersect tangentially and be identical. The asymptotic property follows from the fact that up to an arbitrarily small error, asymptoticity counts like an intersection.

LEMMA 15. *The following statements are equivalent for $y \in H^1_{\text{loc}}(\mathbb{R})$.*

- (a) *y is minimal and satisfies (43);*
- (b) *y is minimal with respect to condition (43);*
- (c) *y is minimal with respect to condition*

$$y(t + NqT) = y(t) + 2Np\pi$$

for some positive integer N .

To prove that (b) \Leftrightarrow (c), let z be minimal in the sense of (c) and y minimal in the sense of (b). The translate $v(t) = z(t + qT) - 2\pi p$ must intersect z at least once because, if not, one gets inductively a contradiction with the condition in (c). By the periodicity conditions

v and z intersect infinitely many times and hence coincide. Thus $z(t + qT) = z(t) + 2\pi p$, and

$$NA_h^{[0,qT]}(z) \geq NA_h^{[0,qT]}(y) = A_h^{[0,NqT]}(y) \geq A_h^{[0,NqT]}(z) = NA_h^{[0,qT]}(z),$$

implying (b) \Leftrightarrow (c). It is easy to show that (c) \Leftrightarrow (a). That (a) \Leftrightarrow (b) is equivalent to showing that all minimals y with fixed boundary conditions verifying (43) yield the same action over one period. If not the difference between the two actions increases indefinitely with the number of periods but remains bounded by minimality on the corresponding large interval.

If y is minimal, the same is true for any of its translates $y(t - qT) + 2p\pi$. They correspond to the same orbit on the torus $\mathbb{R}/2\pi\mathbb{Z} \times T\mathbb{Z}$ parametrized by the (y, t) coordinates. The following lemma shows that there are no self-intersections on this torus.

LEMMA 16. *A minimal $y(t)$ does not intersect any of its translates $y(t - qT) + 2p\pi$.*

There can be at most one intersection, say at t_0 and w.l.g. we can assume that $y(t + qT) < y(t) + 2p\pi$ for $t > t_0$ and $y(t + qT) > y(t) + 2p\pi$ for $t < t_0$. Let $\xi(t) = y(t) - \frac{p}{q}\omega t$ and $\xi_n(t) = \xi(t + qnT)$. It is easy to show that for $t > t_0$ (respectively $t < t_0$) the sequence $(\xi_n(t))$ (respectively $(\xi_{-n}(t))$) is decreasing and that one of the two sequences is bounded from below, say $(\xi_n(t))$. Its limit $\eta(t)$ as $n \rightarrow \infty$ satisfies, by construction, $\eta(t + qT) = \eta(t)$. Now, from the differential equation satisfied by $\xi(t)$, one gets that $|\xi''(t)|$ is bounded on the real line and the boundedness of $|\xi(t)|$ on $[t_0, +\infty[$ follows from the above reasoning. Then the same is true for $|\xi'(t)|$ and Arzela–Ascoli theorem applied to (ξ_n) implies its convergence in the C^1 -topology. As ξ_n and ξ_{n-1} have the same limit η , y and its translate are C^1 -asymptotic, a contradiction to the existence of the intersection t_0 .

THEOREM 31. *Every minimal y has a rotation number*

$$\alpha = \lim_{t \rightarrow \pm\infty} \frac{y(t)}{\omega t}.$$

Moreover,

$$|y(t) - y(0) - \alpha\omega t| \leq c(1 + 2\pi|\alpha|), \tag{48}$$

$$|y'(t)| \leq c, \tag{49}$$

where the constant c does not depend upon y .

Using Lemma 16 and Denjoy theory for mappings on the circle applied to the conjugate of the Poincaré mapping over $[0, T]$ with respect to the projection on the first component of the phase space, restricted to its translates, one obtains the existence of some α such that

$$|y(jT) - y(0) - 2\pi\alpha j| \leq 1 \quad (j \in \mathbb{Z}). \tag{50}$$

To obtain the inequalities, notice that, as $h \in \tilde{C}_T$, we can find, using Sobolev inequality, $\delta > 0$ independent upon y such that, for each $z \in H^1([0, T])$,

$$-aT + \frac{\delta}{4} \int_0^T |z'(t)|^2 dt \leq A_h^{[0,T]}(z) \leq aT + \delta^{-1} \int_0^T |z'(t)|^2 dt.$$

Now if x is the function interpolating linearly y with respect to its values at 0 and T , we get

$$\begin{aligned} -aT + \frac{\delta}{4} \int_0^T |y'(t)|^2 dt &\leq A_h^{[0,T]}(y) \leq A_h^{[0,T]}(x) \\ &\leq aT + \delta^{-1} \int_0^T |x'(t)|^2 dt \\ &= aT + (T\delta)^{-1} |y(T) - y(0)|^2. \end{aligned}$$

Consequently, using (50),

$$\int_0^T |y'(t)|^2 dt \leq \frac{8aT}{\delta} + \frac{4}{T\delta^2} (1 + |\alpha|\omega)^2,$$

which gives, for $t \in [0, T]$,

$$|y(t) - y(0)|^2 = \left(\int_0^t y'(s) ds \right)^2 \leq t \int_0^t |y'(s)|^2 ds \leq \frac{8a}{\delta} + \frac{4}{\delta^2} (1 + 2\pi|\alpha|)^2.$$

Using inequality (50), inequalities (48) and (49) easily follow.

We can now prove the existence of minimals.

THEOREM 32. *For every $\alpha \in \mathbb{R}$, there exists a minimal with rotation number α . Furthermore, C^1 -limits (in the sense of uniform convergence of the function and its derivative on compact subsets of \mathbb{R}) of minimals are minimals, and the rotation number is continuous (i.e., if a sequence of minimals (y_n) with corresponding rotation numbers (α_n) converge to a minimal y with rotation number α in the C^1 -topology, then $\alpha = \lim_{n \rightarrow \infty} \alpha_n$).*

The result follows from Theorem 29 and Lemma 15 when α is rational. If $\alpha = \lim_{n \rightarrow \infty} \frac{p_n}{q_n}$ is irrational, let y_n be a minimal for the boundary conditions

$$y_n(t + q_n T) = y_n(t) + 2\pi p_n$$

such that (translation invariance) $|y_n(0)| \leq 2\pi$. For $t \in [-R, R]$, Theorem 31 yields estimates

$$|y_n(t)| \leq MR, \quad |y'_n(t)| \leq M, \quad |y''_n(t)| \leq M$$

with M independent of t and n , which gives, by Ascoli–Arzela theorem some $C^1([-R, R])$ -converging subsequence and by a diagonal procedure a subsequence which converges C^1 on every compact interval to some limit y . Such a y is minimal with rotation number α .

4.3. Mather set

We now restrict to the case where α is irrational.

THEOREM 33. *The translates $y(t + jT) - 2k\pi$ of a minimal y are totally ordered. The ordering is the same as the ordering of $j\alpha - k$, and is independent of y .*

The mapping $(j, k) \mapsto j\alpha - k$ is one-to-one and we may write

$$y(t + jT) - 2k\pi := u(t|\beta), \quad \beta = j\alpha - k,$$

with $u(t|\cdot)$ so defined for a dense set of reals β and strictly monotone in β . It can therefore be easily extended to all real β by

$$u^+(t|\beta) := \lim_{\gamma \rightarrow \beta^+} u(t|\gamma), \quad u^-(t|\beta) := \lim_{\gamma \rightarrow \beta^-} u(t|\gamma),$$

DEFINITION 13. The Mather sets M_α and $M_\alpha(t)$ of Equation (23) are defined by

$$M_\alpha^\pm = \{u^\pm(\cdot|\beta) : \beta \in \mathbb{R}\}, \quad M_\alpha^\pm(t) = \{u^\pm(t|\beta) : \beta \in \mathbb{R}\},$$

$$M_\alpha = M_\alpha^+ \cup M_\alpha^-, \quad M_\alpha(t) = M_\alpha^+(t) \cup M_\alpha^-(t).$$

It can be shown that they do not depend upon the minimal y chosen for their construction and that they have the following properties.

THEOREM 34. *The Mather sets have the following properties.*

- (1) $M_\alpha(t)$ is invariant under the Poincaré map $y(t) \mapsto y(t + T)$ and the translation $y \mapsto y + 2\pi$.
- (2) $M_\alpha(t)$ is closed without isolated points.
- (3) $M_\alpha(t)$ does not contain any nonempty closed strict subset invariant under Poincaré map and translation.
- (4) $M_\alpha(t)$ is either \mathbb{R} or is nowhere dense.
- (5) M_α consists of trajectories of some vector field $y' = \psi(y, t)$ defined either on a Cantor-like part or on the whole of the (y, t) -plane.

Hai Huang has proved in [57], for pendulum-type equations, the generic existence of invariant cantori (minimal orbits defining a Cantor set on the torus).

5. KAM theory and Lagrange stability

5.1. Twist mappings

The existence of quasi-periodic solutions to the forced pendulum can be obtained by applying to the Poincaré’s operator some theorem for twist mappings, that we recall now.

Let $A = S^1 \times [a, b]$ be an annulus in \mathbb{R}^2 , and $\phi : A \rightarrow \mathbb{R}^2$ a mapping with lift (40). Moser’s twist theorem [87] can be stated as follows.

LEMMA 17. *Let $l \geq 5$, $\beta \in C^5(\mathbb{R})$ be such that $|\beta'(r)| \geq \nu > 0$ for all $r \in [a, b]$, let $\varepsilon > 0$, and let α be an irrational number satisfying the Diophantine conditions*

$$\left| \alpha - \frac{m}{n} \right| \geq \gamma n^{-\tau},$$

for some positive γ, τ , and all integers $n > 0, m$. Then there exists $\delta = \delta(\varepsilon, l, \alpha) > 0$ such that each area-preserving mapping $\phi : A \rightarrow \mathbb{R}^2$ whose lift (40), with $f, g \in C^l$, is such that

$$|f - \beta|_{C^l} + |g - r|_{C^l} < \nu\delta,$$

possesses an invariant curve of the form

$$\theta = \tau + w(\tau), \quad r = c + z(\tau),$$

in A , where w, z are of class C^1 , 1-periodic, $|w|_{C^1} + |z|_{C^1} < \varepsilon, c \in]a, b[$, on which ϕ takes the form $\tau \rightarrow \tau + \alpha$.

The following result has been proved independently by Levi [66] and by Moser [89,94], using Moser twist theorem.

THEOREM 35. *Assume that $h \in \tilde{C}_T$. For any $\alpha \in]0, 1[$ satisfying the set of Diophantine inequalities*

$$\left| \alpha - \frac{m}{n} \right| > \frac{\gamma}{n^{2+\mu}},$$

for some $\gamma > 0$ and $\mu > 0$, and all integers m, n with $n > 0$, there exists an integer $k_0 = k_0(\gamma, \mu)$ such that the Poincaré mapping associated to (23) possesses, for all integers k with $|k| \geq k_0$, a countable set of invariant curves $r = f_{\alpha+k}(\theta) \equiv f_{\alpha+k}(\theta + 2\pi)$.

Physically, the solutions correspond to quasiperiodic rotations with average angular velocity $\omega + k$. The basic idea of the proof is that, for large velocities y' , the forced pendulum equation has solutions which are close to those of the integrable system $y'' = 0$. One first shows that, because of condition $\bar{h} = 0$, the Poincaré map \mathcal{P} is exact on the phase cylinder $\{(y, z) \in S^1 \times \mathbb{R}\}$ (i.e., $\int_{C_0} z \, dy = \int_{C_1} z \, dy$ if C_0 is an arbitrary noncontractible circle going

once around the cylinder and C_1 its image under \mathcal{P}). Then one shows that \mathcal{P} is C^4 -close to a twist mapping for large y' , namely

$$\mathcal{P}_1(\theta, r) = \theta + r + \bar{H} + r_1(\theta, r), \quad \mathcal{P}_2(\theta, r) = r + r_2(\theta, r),$$

where $\bar{H} = \int_0^T \int_0^t h(\tau) \, d\tau \, dt$ and $\|r_1\|_{C^4} + \|r_2\|_{C^4} < C|z|^{-1}$.

Independently, and by the same approach, Jiangong You [130] has proved a similar result, and has completed it as follows.

Notice that an invariant curve with rotation number α of the Poincaré mapping of Equation (23) give rise to an invariant torus with rotation numbers $(1, \alpha)$ in the extended phase space $S^1 \times \mathbb{R} \times \mathbb{R}$ of the corresponding (t, y, y') .

THEOREM 36. *Equation (23) has an invariant torus if and only if $h \in \tilde{C}_T$. If it is the case, there exists $\alpha^* > 0$ such that, for every irrational number $\alpha > \alpha^*$ satisfying the Diophantine condition*

$$\left| \alpha - \frac{m}{n} \right| > \frac{\gamma}{n^{5/2}},$$

for all integers m and n with $n > 0$, and some $\gamma > 0$, Equation (23) has an invariant torus with rotation number $(1, \alpha)$.

The necessity is proved by observing that the *Calabi invariant* of \mathcal{P} , defined by $C(\mathcal{P}) = \int_{\mathcal{P}(\gamma)} r \, d\theta - \int_{\gamma} r \, d\theta$, where γ is a circle in $\mathbb{R} \times S^1$ homotopic to a circle $\{r\} \times S^1$, is equal to \bar{h} . Thus, if \mathcal{P} possesses an invariant closed curve which is homotopic to $\{r\} \times S^1$, one has $C(\mathcal{P}) = 0$, and hence $\bar{h} = 0$.

We now show that those results imply a property called Lagrange stability, answering a question raised by Moser in the Introduction of [87].

DEFINITION 14. Equation (23) is called *Lagrange stable* if any solution of (14) is bounded over \mathbb{R} in the phase cylinder $\{(y \bmod 2\pi, y')\}$.

Physically, this means that any solution of (14) has angular velocity bounded over \mathbb{R} . The Lagrange stability is a consequence of the results of Levi and Moser described above. See also [67].

THEOREM 37. *If $h \in \tilde{C}_T$, then for any sufficiently large $N > 0$, there exists $M = M(N)$ such that any solution $y(t)$ of Equation (23) with $|y'(0)| \leq M$ satisfies $|y'(t)| \leq N$ for all $t \in \mathbb{R}$.*

Independently, You [130] also proved the Lagrange stability of (23) and completed the result as follows.

THEOREM 38. *Equation (23) is Lagrange stable if and only if $h \in \tilde{C}_T$.*

Indeed, if $\bar{h} = 0$, then, from Theorem 36, Equation (23) has an invariant torus with rotation number $(1, \alpha)$ for infinitely many sufficiently large irrational numbers α . Letting $u = -y$, $v = -z$, Equation (23) becomes

$$u'' + a \sin u = -h(t),$$

and has an invariant torus with rotation number $(1, \alpha)$ for infinitely many sufficiently large irrational numbers α . Thus Equation (23) has an invariant torus with rotation number $(1, -\alpha)$. One uses two such invariant tori to confine any solutions in their interior. To prove the necessity, one shows, using the estimates on \mathcal{P} , that Equation (23) has a solution with y' unbounded if $\bar{h} \neq 0$.

The destruction of invariant tori with rotation number $(1, \omega)$ and ω a Liouville irrational in pendulum-type equations has been considered by Hai Huang [56].

Let us notice the Mather's theory of previous section can also be expressed in the frame of mappings on an annulus, which enlightens its relation with KAM theory. We keep the notations of Section 3.8.

DEFINITION 15. $\phi : A \rightarrow A$ is a *monotone twist homeomorphism* if it preserves orientation, preserves boundary components of A and if its lift (40) is such that $f(\theta, \cdot)$ is strictly monotone for each θ . For definiteness, we assume it to be increasing.

Let $F^j(\theta, r) = (\theta_j, r_j)$, and

$$\alpha_r(\phi) = \lim_{j \rightarrow \infty} \frac{\theta_j}{j}$$

be its *rotation number*. The *twist interval* of ϕ , $[\alpha_a(\phi), \alpha_b(\phi)]$, is defined up to an integral translation.

If $\phi^q(z) = z$, then $F^q(\theta, r) = (\theta + 2p\pi, r)$, for some integer p determined up to a multiple of q .

$\frac{p}{q}$ is the rotation number of z . One calls a point $z = (\theta, r)$ a *Birkhoff point of type (p, q)* if there exists a sequence $(\theta_n, r_n)_{n \in \mathbb{Z}}$ such that $(\theta_0, r_0) = (\theta, r)$, $\theta_{n+1} > \theta_n$, $(\theta_{n+q}, r_{n+q}) = (\theta_n + 2\pi, r_{n+q})$, $(\theta_{n+q}, r_{n+q}) = F(\theta_n, r_n)$ ($n \in \mathbb{N}$). One has *Birkhoff's twist theorem* [16].

LEMMA 18. Let $\phi : A \rightarrow A$ be an area-preserving monotone twist homeomorphism and

$$\frac{p}{q} \in [\alpha_a(\phi), \alpha_b(\phi)],$$

with p, q relatively prime. Then ϕ has at least two Birkhoff points of type (p, q) .

The situation is different for α irrational.

DEFINITION 16. A *Mather set of rotation number α* for F is a closed invariant set for F with representation $\theta = u(\tau), r = v(\tau)$, where u is monotone increasing, $u - Id$ and v are 1-periodic (not necessarily continuous !), and

$$u(\tau + \alpha) = u(\tau) + f(u(\tau), v(\tau)), \quad v(\tau + \alpha) = g(u(\tau), v(\tau)).$$

One has the *Aubry–Mather’s twist theorem* [7,69].

LEMMA 19. Let $\phi : A \rightarrow A$ be an area-preserving monotone twist homeomorphism and let $\alpha \in [\alpha_a(\phi), \alpha_b(\phi)]$ be irrational. Then there exists an invariant Mather set Γ_α with rotation number α . Furthermore, Γ_α is a subset of a closed curve $r = \gamma(\theta)$ where γ is 2π -periodic and Lipschitz continuous, i.e., $v(\tau) = \gamma(u(\tau))$.

When u and v are continuous, Γ_α defines a Lipschitz continuous invariant curve. When u and v have countably many discontinuities, Γ_α can be seen as a Cantor set on the curve $r = \gamma(\theta)$.

5.2. Chaotic dynamics

We first recall the definition of chaotic dynamics.

DEFINITION 17. Equation (23) displays *chaotic dynamics* if

- (i) the solutions of Equation (23) depend sensitively on the initial conditions;
- (ii) Equation (23) has infinitely many periodic solutions with diverging periods;
- (iii) Equation (23) has an uncountable number of bounded, nonperiodic solutions;
- (iv) the Poincaré map associated to Equation (23) has positive topological entropy.

The following definition is due to Serra, Tarallo and Terraccini [121]. Without loss of generality we take $T = 1$. Let $n \geq 1$ be an integer, $h \in \tilde{C}_1$, and

$$A_{h,n} : H_n^1 \rightarrow \mathbb{R}, \quad y \mapsto \int_0^n \left[\frac{y'^2(t)}{2} + a \cos y(t) + h(t)y(t) \right] dt.$$

DEFINITION 18. y_0 and y_1 are *consecutive minimizers* of A_h on H_n^1 if

- (1) $A_{h,n}(y_0) = A_{h,n}(y_1) = \min_{H_n^1} A_{h,n} := c_{h,n}$.
- (2) $y_0(t) < y_1(t)$ for all $t \in [0, n]$.
- (3) $y \in H_n^1 \cap [y_0, y_1]$ and $A_{h,n}(y) = c_{h,n}$ imply $y \in \{y_0, y_1\}$.

This notion is weaker than the isolatedness or nondegeneracy of minimizers in the variational sense.

Write $y(\pm\infty) = u$ if $\lim_{t \rightarrow \pm\infty} (y(t) - u(t)) = 0$, and, following an idea of Rabinowitz [115], define the functional J by

$$J(y) = \sum_{j \in \mathbb{Z}} \left(\int_{j_n}^{(j+1)n} \left[\frac{y'^2(t)}{2} + a \cos y(t) + h(t)y(t) \right] dt - c_{h,n} \right) \tag{51}$$

over the classes of functions

$$\begin{aligned} \Gamma(y_0, y_1) &= \{y \in H_{\text{loc}}^1 : y(-\infty) = y_0, y(+\infty) = y_1\}, \\ \Gamma(y_1, y_0) &= \{y \in H_{\text{loc}}^1 : y(-\infty) = y_1, y(+\infty) = y_0\}. \end{aligned} \tag{52}$$

Define

$$\begin{aligned} \mathcal{I} &=]y_0(0), y_1(0)[, \\ \mathcal{S}(y_0, y_1) &= \left\{y(0) \in \mathcal{I} : y \in \Gamma(y_0, y_1), J(y) = \min_{\Gamma(y_0, y_1)} J\right\}, \\ \mathcal{S}(y_1, y_0) &= \left\{y(0) \in \mathcal{I} : y \in \Gamma(y_1, y_0), J(y) = \min_{\Gamma(y_1, y_0)} J\right\}. \end{aligned}$$

The following result has been proved in [21].

THEOREM 39. *Let $h \in \tilde{\mathcal{C}}_1$. If $A_{h,n}$ has two consecutive minimizers y_0 and y_1 and if*

$$\mathcal{S}(y_0, y_1) \neq \mathcal{I} \quad \text{and} \quad \mathcal{S}(y_1, y_0) \neq \mathcal{I}, \tag{53}$$

then Equation (23) displays chaotic dynamics.

A first important step in proving the above theorem, which is interesting in itself, is the following existence result for *heteroclinic* (or *one-bump*) solutions between two consecutive minimizers y_0 and y_1 on H_1^1 .

PROPOSITION 6. *Let $c_0 = \inf_{\Gamma(y_0, y_1)} J$, $c_1 = \inf_{\Gamma(y_1, y_0)} J$. There exists $q_0 \in \Gamma(y_0, y_1)$ and $q_1 \in \Gamma(y_1, y_0)$ such that $J(q_0) = c_0$, $J(q_1) = c_1$. The functions q_0 and q_1 solve Equation (23).*

A second step is the existence of multi-bump solutions. One makes the convention that the indices in y, c, q, \dots have to be taken mod 2.

PROPOSITION 7. *Assume that y_0 and y_1 are two consecutive minimizers of A_h over H_1^1 and that condition (53) holds. Then, for every sufficiently small $\delta > 0$, there exists $m = m(\delta) \in \mathbb{N}$ such that for every sequence $(p_i)_{i \in \mathbb{Z}}$ such that $p_{i+1} - p_i \geq 4m$, and for every $j, k \in \mathbb{Z}$ with $j < k$, there exists a classical solution q of Equation (23) satisfying*

$$\begin{aligned} y_0(t) &< q(t) < y_1(t) \quad (t \in \mathbb{R}), \\ q(-\infty) &= y_j, \quad q(+\infty) = y_{k+1}, \end{aligned}$$

and, for all $i = j, \dots, k$,

$$|q(p_i - m) - y_i(p_i - m)| \leq \delta, \quad |q(p_i + m) - y_{i+1}(p_i + m)| \leq \delta.$$

From this result, one deduces the existence of solutions with infinitely many bumps.

PROPOSITION 8. *Assume that y_0 and y_1 are two consecutive minimizers of A_h over H_1^1 and that condition (53) holds. Then, for every sufficiently small $\delta > 0$, there exists $m = m(\delta) \in \mathbb{N}$ such that for every sequence $(p_i)_{i \in \mathbb{Z}}$ such that $p_{i+1} - p_i \geq 4m$, there exists a classical solution q of Equation (23) satisfying*

$$y_0(t) < q(t) < y_1(t) \quad (t \in \mathbb{R}),$$

and

$$|q(p_i - m) - y_i(p_i - m)| \leq \delta, \quad |q(p_i + m) - y_{i+1}(p_i + m)| \leq \delta \quad (i \in \mathbb{Z}).$$

Notice that, by choosing the points p_i in a periodic way, a slight modification of the argument gives the existence of infinitely many periodic solutions of Equation (23) with arbitrary large period. Notice also that it has been shown in [21] that condition (53) is weaker than the standard transversality assumption.

A natural question is to see for which h is assumption (53) satisfied. A result in this direction has been given in [22,23]. Let

$$\tilde{\mathcal{C}} := \bigcup_{n \in \mathbb{N}} \tilde{\mathcal{C}}_n,$$

endowed with the L^∞ -topology.

THEOREM 40. *There exists a dense subset \mathcal{H} of $\tilde{\mathcal{C}}$ such that for every $h \in \mathcal{H}$, Equation (23) displays chaotic dynamics. Moreover, for all $n \in \mathbb{N}$, $\mathcal{H} \cap \tilde{H}_n^1$ is open in \tilde{H}_n^1 .*

To prove this theorem, one first refers to Theorem 10 to prove the result in a simplified setting. If $h \in \tilde{\mathcal{C}}_n$, $y \in H_n^1$ is a true minimizer for $A_{h,n}$ over H_n^1 if $A_{h,n}(y) = c_{h,n}$ and $\bar{y} \in [0, 2\pi[$.

PROPOSITION 9. *For each positive integer n , the set \mathcal{H}_n of forcing terms $h \in \tilde{\mathcal{C}}_n$, such that $A_{h,n}$ has only one nondegenerate true minimizer over H_n^1 is dense in H_n^1 , and open in H_{kn}^1 for any fixed $k \in \mathbb{N}$.*

Taking then $h \in \mathcal{H}_n$, fixing $k \in \mathbb{N}$ and $h_1 \in \tilde{H}_{kn}^1$, one considers the perturbed equation

$$y'' + a \sin y = h(t) + \varepsilon h_1(t) \tag{54}$$

for ε small, y_0^ε its true minimizer and $y_1^\varepsilon = y_0^\varepsilon + 2\pi$. Regularity estimates are obtained on some associated heteroclinic orbits, using in particular a Lyapunov–Schmidt argument, and this regularity is used to compute some analogue of a primitive of the Melnikov function, in the line of [3].

Similar results have been obtained by Offin and Yu Hongfan [97].

6. Bounded forcing

6.1. Bounded functions and their averages

T -periodic functions are special cases of bounded functions.

DEFINITION 19. The function $p: \mathbb{R} \rightarrow \mathbb{R}$ is called *bounded* if there exists $M > 0$ such that, for all $t \in \mathbb{R}$, $|p(t)| \leq M$.

The concept of mean value of a T -periodic function has been extended by Tineo [124] to some classes of functions containing the bounded ones.

DEFINITION 20. Let $p = p^* + p^{**}: \mathbb{R} \rightarrow \mathbb{R}$ be continuous, with p^{**} bounded and p^* having a bounded primitive. The *lower* (respectively *upper*) *average* of p is defined by

$$\bar{p}_L = \lim_{r \rightarrow +\infty} \inf_{t-s \geq r} \frac{1}{t-s} \int_s^t p(u) \, du,$$

(respectively

$$\bar{p}_U = \lim_{r \rightarrow +\infty} \sup_{t-s \geq r} \frac{1}{t-s} \int_s^t p(u) \, du).$$

It is easy to verify that

$$\begin{aligned} -\infty < \bar{p}_L &\leq \bar{p}_U < +\infty, \\ \bar{p}_L &= \bar{p}_L^{**}, \quad \bar{p}_U = \bar{p}_U^{**}, \end{aligned}$$

and that, if p is continuous and T -periodic,

$$\bar{p}_L = \bar{p}_U = \bar{p}.$$

Notice also that if p is continuous and T -periodic, then $\bar{p} = 0$ if and only if p has a T -periodic primitive.

6.2. A necessary condition for the existence of bounded solutions

Let $g: \mathbb{R} \times \mathbb{R} \rightarrow \mathbb{R}$ be bounded over $\mathbb{R} \times [-r, r]$ for each $r > 0$ and continuous, and consider the differential equation

$$y'' + cy' = g(t, y). \tag{55}$$

DEFINITION 21. A solution $y: \mathbb{R} \rightarrow \mathbb{R}$ of Equation (55) is said to be *bounded* if y and y' are bounded.

Consider the dissipative forced pendulum-type equation

$$y'' + cy' + a \sin y = h(t), \tag{56}$$

where $a > 0$, $c \geq 0$, and $h : \mathbb{R} \rightarrow \mathbb{R}$ is continuous and bounded. It is easy to extend Proposition 1 to bounded forcings and bounded solutions.

PROPOSITION 10. *If Equation (56) has a bounded solution, then*

$$-a \leq \bar{h}_L \leq \bar{h}_U \leq a. \tag{57}$$

To show this result, one notices that, if y is a bounded solution of (56), one has, for each $t > s$,

$$\frac{y'(t) - y'(s)}{t - s} + c \frac{y(t) - y(s)}{t - s} + \frac{a}{t - s} \int_s^t \sin y(\tau) \, d\tau = \frac{1}{t - s} \int_s^t h(\tau) \, d\tau,$$

and, given $\varepsilon > 0$, one can find T_0 such that, for all $T \geq T_0$ and all t, s such that $t - s \geq T$, one has

$$-\varepsilon \leq \frac{y(t) - y(s)}{t - s} \leq \varepsilon, \quad -\varepsilon \leq \frac{y'(t) - y'(s)}{t - s} \leq \varepsilon.$$

Consequently, for $t - s \geq T$, we get

$$-(1 + c)\varepsilon - a \leq \frac{1}{t - s} \int_s^t h(\tau) \, d\tau \leq (1 + c)\varepsilon + a,$$

and (57) follows easily.

6.3. Sufficient conditions for the existence of bounded solutions

The following existence result for bounded solutions of Equation (55) goes back Opial [98] (see also [80]).

LEMMA 20. *If there exists $r_- < r_+$ such that*

$$g(t, r_-) \leq 0 \leq g(t, r_+)$$

for all $t \in \mathbb{R}$, then Equation (55) has at least one bounded solution such that

$$r_- \leq y(t) \leq r_+$$

for all $t \in \mathbb{R}$.

The first easy consequence for Equation (56) is the one-dimensional case of a result for elliptic partial differential equations due to Fournier, Szulkin and Willem [48].

THEOREM 41. *If $c \geq 0$ and if*

$$-a \leq h(t) \leq a, \quad (58)$$

for all $t \in \mathbb{R}$, Equation (56) has at least one bounded solution y such that

$$\frac{\pi}{2} \leq y(t) \leq \frac{3\pi}{2}$$

for all $t \in \mathbb{R}$.

REMARK 1. *It is clear that condition (58) implies condition (57).*

Another existence result, first proved in [81], follows from applying Lemma 20 to an equivalent formulation for the forced pendulum problem together with the following result of Ortega on bounded solutions of second order linear equations [103] (see also [80]). We define as usual the *oscillation* $\text{osc}_{\mathbb{R}} z$ of the function $z: \mathbb{R} \rightarrow \mathbb{R}$ by

$$\text{osc}_{\mathbb{R}} z = \sup_{\mathbb{R}} z - \inf_{\mathbb{R}} z.$$

LEMMA 21. *If $c > 0$ and $h: \mathbb{R} \rightarrow \mathbb{R}$ is continuous, then equation*

$$y'' + cy' = h(t) \quad (59)$$

has a bounded solution if and only if h has a bounded primitive. If it is the case, any bounded solution y of Equation (59) verifies the inequality

$$\text{osc}_{\mathbb{R}} y \leq \frac{1}{c} \text{osc}_{\mathbb{R}} H, \quad (60)$$

where

$$H(t) = \int_0^t h(s) \, ds.$$

Furthermore, for each h with bounded primitive, Equation (59) has a unique (symmetrized) bounded solution H_c such that

$$\sup_{\mathbb{R}} H_c = -\inf_{\mathbb{R}} H_c = \frac{1}{2} \text{osc}_{\mathbb{R}} H_c. \quad (61)$$

THEOREM 42. *If $c > 0$, $h = h^* + h^{**}$ where h^{**} is bounded and h^* has a bounded primitive over \mathbb{R} , and if inequalities*

$$\text{osc}_{\mathbb{R}} H_c^* \leq \pi, \tag{62}$$

and

$$\|h^{**}\|_{\infty} \leq a \cos\left(\frac{\text{osc}_{\mathbb{R}} H_c^*}{2}\right) \tag{63}$$

hold, where H_c^* is the symmetrized bounded solution of $y'' + cy' = h^*(t)$, then Equation (56) has at least one solution y such that

$$\frac{\pi}{2} + H_c^*(t) \leq y(t) \leq \frac{3\pi}{2} + H_c^*(t),$$

for all $t \in \mathbb{R}$. When $c = 0$, the above result holds if $h^{**} = 0$, $h = h^*$ has a second primitive H^1 bounded over \mathbb{R} and H_c^* is replaced by H^1 in (67).

To prove this theorem, one sees that y is a bounded solution of Equation (56), if and only if z defined by

$$y(t) = z(t) + H_c^*(t),$$

is a bounded solution of equation

$$z'' + cz' + a \sin(z + H_c^*(t)) = h^{**}(t). \tag{64}$$

One checks easily that the conditions of Lemma 20 hold for $r_- = \pi/2$ and $r_+ = 3\pi/2$.

REMARK 2. It follows from inequality (60) that, given $h = h^* + h^{**}$, condition (62) holds as soon as

$$c \geq \frac{1}{\pi} \text{osc}_{\mathbb{R}} H^*.$$

Consequently, when h has a bounded primitive, Equation (56) has a bounded solution for all sufficiently large c . The question remains open for other values of c .

6.4. Local uniqueness of bounded solutions

By straightening the assumptions of Theorems 41 and 42, one obtains the local uniqueness of the obtained bounded solutions by using a maximum principle proved in [19].

LEMMA 22. Let $\alpha > 0$, $\beta \in \mathbb{R}$ and $\gamma : \mathbb{R} \rightarrow \mathbb{R}$ bounded and continuous. If the function $r \in C^2(\mathbb{R}, \mathbb{R})$ is bounded together with its first two derivatives and satisfies the differential inequality

$$r''(t) \geq \gamma(t)r'(t) + \alpha r(t) - \beta,$$

then

$$\sup_{\mathbb{R}} r \leq \frac{\beta}{\alpha}.$$

LEMMA 23. Let $c \in \mathbb{R}$ and $f : \mathbb{R} \rightarrow \mathbb{R}$ be bounded, continuous and such that

$$f(t) \leq -\delta < 0$$

for all $t \in \mathbb{R}$. Then the unique bounded solution of equation

$$y'' + cy' + f(t)y = 0$$

is the trivial one.

THEOREM 43. If $c \geq 0$ and if

$$\|h\|_{\infty} < a, \tag{65}$$

holds, there exists $\varepsilon > 0$ such that Equation (56) has a unique solution y such that

$$\frac{\pi}{2} + \varepsilon \leq y(t) \leq \frac{3\pi}{2} - \varepsilon \tag{66}$$

for all $t \in \mathbb{R}$.

This result follows from the fact that for some sufficiently small $\varepsilon > 0$, $r_- = \frac{\pi}{2} + \varepsilon$ and $r_+ = \frac{3\pi}{2} - \varepsilon$ satisfy the condition of Lemma 20 and that $\cos u \leq -\delta$ for some $\delta > 0$ when $u \in [r_-, r_+]$. The uniqueness then follows from Lemma 23.

THEOREM 44. If $c > 0$, $h = h^* + h^{**}$ where h^{**} is bounded and h^* has a bounded primitive over \mathbb{R} , and if inequalities

$$\text{osc}_{\mathbb{R}} H_c^* < \frac{\pi}{2}, \tag{67}$$

$$\|h^{**}\|_{\infty} \leq \frac{a\sqrt{2}}{2} \left[\sin\left(\frac{\text{osc}_{\mathbb{R}} H_c^*}{2}\right) + \cos\left(\frac{\text{osc}_{\mathbb{R}} H_c^*}{2}\right) \right], \tag{68}$$

hold, then there exists $\varepsilon > 0$ such that Equation (56) has a unique solution y satisfying the inequality

$$\frac{\pi}{2} + \varepsilon \leq y(t) \leq \frac{3\pi}{2} - \varepsilon, \tag{69}$$

for all $t \in \mathbb{R}$. When $c = 0$, the above result holds if $h^{**} = 0$, $h = h^*$ has a second primitive H^1 bounded over \mathbb{R} and H_c^* is replaced by H^1 in (67).

The proof follows lines similar to that of Theorem 43.

7. Almost periodic forcings

7.1. Almost periodic functions

An interesting intermediate class between the bounded and the periodic functions is the class of almost periodic solutions in the sense of H. Bohr [44].

DEFINITION 22. $f : \mathbb{R} \rightarrow \mathbb{R}$ is (Bohr)-almost periodic if, for each $\varepsilon > 0$, there exists $L > 0$ such that any interval of length L contains at least some τ such that $\forall t \in \mathbb{R}$, $|f(t + \tau) - f(t)| < \varepsilon$.

Such a function is necessarily bounded and uniformly continuous over \mathbb{R} . The following result gives an alternative definition of the space $AP(\mathbb{R})$ of (Bohr)-almost periodic functions. Let us denote by $TP(\mathbb{R})$ the space of real trigonometric polynomials

$$p_N(t) = \sum_{k=-N}^N p_k \exp(i\lambda_k t),$$

where $p_k = \bar{p}_{-k}$ and $\lambda_k \in \mathbb{R}$ ($-N \leq k \leq N$).

LEMMA 24. The space $AP(\mathbb{R})$ is the closure of $TP(\mathbb{R})$ for the uniform norm over \mathbb{R} .

If $f \in AP(\mathbb{R})$ and $\lambda \in \mathbb{R}$, the limit

$$f_\lambda := \lim_{T \rightarrow \infty} \frac{1}{T} \int_0^T f(t) \exp(-i\lambda t) dt$$

exists, $\bar{f}_\lambda = f_{-\lambda}$, and the set Λ of $\lambda \in \mathbb{R}$ for which $f_\lambda \neq 0$ is at most countable. The series

$$\sum_{\lambda: f_\lambda \neq 0} f_\lambda \exp(i\lambda t) \tag{70}$$

is called the *Fourier series* associated to f . The Fourier coefficient

$$f_0 = \lim_{T \rightarrow \infty} \frac{1}{T} \int_0^T f(t) dt$$

is called the *mean value* of f . If f has an almost-periodic primitive, then $f_0 = 0$, but, in contrast to the periodic case, an almost periodic function with mean value zero needs not to have an almost-periodic primitive. It is only the case if its primitive is itself bounded.

More general classes of almost periodic functions have been defined by Besicovitch [14]. If $p \in TP(\mathbb{R})$ define $\|p\|_{B^2}$ by

$$\|p\|_{B^2} = \left[\limsup_{T \rightarrow \infty} \left\{ \frac{1}{T} \int_0^T |p(t)|^2 dt \right\} \right]^{1/2},$$

and define $B^2(\mathbb{R})$ to be the space of equivalence classes of functions $f : \mathbb{R} \rightarrow \mathbb{R}$ such that $\lim_{n \rightarrow \infty} \|f - p_n\|_{B^2} = 0$ for some sequence (p_n) in $TP(\mathbb{R})$, under the equivalence relation

$$f \sim g \iff \|f - g\|_{B^2} = 0. \quad (71)$$

If f and g belong to $B^2(\mathbb{R})$, and $\lambda \in \mathbb{R}$, one can show that the limits

$$\begin{aligned} & \lim_{T \rightarrow \infty} \frac{1}{T} \int_0^T |f(t)|^2 dt, \\ \langle f, g \rangle_{B^2} & := \lim_{T \rightarrow \infty} \frac{1}{T} \int_0^T f(t)g(t) dt, \\ f_\lambda & := \lim_{T \rightarrow \infty} \frac{1}{T} \int_0^T f(t) \exp(-i\lambda t) dt \end{aligned}$$

exist and that $f_\lambda \neq 0$ on an at most countable set, so that the *Fourier series* (70) of f is well defined. Because of the fact that two functions in the same equivalence class for (71) can differ on a set of positive and even of infinite measure, the use of $B^2(\mathbb{R})$ in the study of differential equations gives rather weak existence assertions. Work in this direction for Equation (56) has been done by Belley, Fournier and Saadi Drissi [11,12], who have also considered some subspaces of $B^2(\mathbb{R})$ whose functions behave more like periodic ones.

7.2. Almost periodic solutions

Combining some results on the existence and uniqueness of bounded solutions over \mathbb{R} with Amerio's criterion on the existence of almost periodic solutions (see, e.g., [44]), Fink [43] has given in 1968 some partial extension of the *method of upper and lower solutions* to almost periodic solutions. A special case of his results is the following proposition.

LEMMA 25. Let $c \in \mathbb{R}$, $g \in C^1(\mathbb{R}, \mathbb{R})$ and h be continuous and almost periodic. Assume that there exist $r_- < r_+$ such that $g'(x) > 0$ for all $x \in [r_-, r_+]$, and

$$g(r_-) + h(t) \leq 0 \leq g(r_+) + h(t)$$

for all $t \in \mathbb{R}$. Then equation

$$y'' + cy' = g(y) + h(t)$$

has a unique almost periodic solution y such that $a \leq y(t) \leq b$ for all $t \in \mathbb{R}$.

Notice that, as shown by Ortega and Tarallo [109], the monotonicity condition on g cannot be dropped in Lemma 25.

Lemma 25 implies the following existence theorem [81], also proved independently by Fournier, Szulkin and Willem [48] as a special case of a more general result for elliptic partial differential equations. When $c = 0$, Theorem 45 generalizes an earlier approximate solvability result of Blot [17] for Equation (23), based upon variational techniques and convex analysis, which only provides the existence for a dense subset of forcing functions h .

THEOREM 45. For each $c \geq 0$ and each $h \in AP(\mathbb{R})$ such that $\|h\|_\infty < a$, Equation (56) has a unique solution $y \in AP(\mathbb{R})$ such that $\pi/2 < y(t) < 3\pi/2$ for all $t \in \mathbb{R}$.

Indeed, the condition upon $\|h\|_\infty$ implies the existence of $\varepsilon > 0$ such that $a = \frac{\pi}{2} + \varepsilon$ and $b = \frac{3\pi}{2} - \varepsilon$ satisfy the conditions of Lemma 13.

Similar arguments applied to the equivalent formulation of the forced pendulum equation lead to the following existence theorem, first proved in [81]. When $c = 0$, Theorem 46 generalizes an earlier approximate solvability result of Blot [18] for Equation (23), based upon variational techniques and convex analysis, which gives existence for a dense subset of forcing functions h only. Subsequently, Blot and Pennequin [20] have extended Blot's result to the case of quasi-periodic forcing terms.

THEOREM 46. If $c > 0$, $h = h^* + h^{**}$ where h^{**} is almost periodic and h^* has an almost periodic primitive, and if conditions (67) and (68) are satisfied, then there exists $\varepsilon > 0$ such that Equation (56) has a unique almost periodic solution verifying inequality (69). If $c = 0$, and $h \in C$ has an almost periodic second primitive H^1 satisfying (67) with H_c^* replaced by H^1 , then the same conclusion holds.

The following result of Lagrange unstability-type for almost periodic forcings has been proved by Hai Huang [58].

THEOREM 47. Equation (23) possesses infinitely many unbounded solutions on a cylinder $S^1 \times \mathbb{R}$ for any almost periodic h with nonvanishing mean value.

References

- [1] F. Alessio, M. Calanchi and E. Serra, *Complex dynamics in a class of reversible equations*, Nonlinear Analysis and its Applications to Differential Equations (Lisbon, 1998), Birkhäuser, Boston (2001), 147–159.
- [2] J.M. Alonso, *Nonexistence of periodic solutions for a damped pendulum equation*, Differential Integral Equations **10** (1997), 1141–1148.
- [3] A. Ambrosetti and M. Badiale, *Homoclinics: Poincaré–Melnikov type results via a variational approach*, Ann. Inst. H. Poincaré, Anal. Non Linéaire **15** (1998), 233–252.
- [4] A. Ambrosetti and P. Rabinowitz, *Dual variational methods in critical point theory and applications*, J. Functional Anal. **14** (1973), 349–381.
- [5] Z. Amine and R. Ortega, *Existence of asymptotically stable periodic solutions of a forced equation of Liénard type*, Nonlinear Anal. **22** (1994), 993–1003.
- [6] A.A. Andronov, A.A. Vitt and S.E. Khaikin, *Theory of Oscillators*, Moscow (1959) (in Russian). English translation: Pergamon, Oxford (1966) and Dover, New York (1987).
- [7] S. Aubry and P.Y. Le Daeron, *The discrete Fraenkel–Kontorova model and its extensions I*, Physica D **8** (1983), 381–422.
- [8] V. Bangert, *Mather sets for twist maps and geodesics on tori*, Dynam. Report. **1** (1988), 1–56.
- [9] P.W. Bates, *Reduction theorems for a class of semilinear equations at resonance*, Proc. Amer. Math. Soc. **24** (1982) 73–78.
- [10] J.M. Belley, G. Fournier and J. Hayes, *Existence of almost periodic weak type solutions for the conservative forced pendulum equation*, J. Differential Equations **124** (1996), 205–224.
- [11] J.M. Belley, G. Fournier and K. Saadi Drissi, *Almost periodic weak solutions to forced pendulum type equations without friction*, Aequationes Math. **44** (1992), 100–108.
- [12] J.M. Belley, G. Fournier and K. Saadi Drissi, *Solutions faibles presque périodiques d'équation différentielle du type du pendule forcé*, Bull. Cl. Sci. Acad. R. Belgique **3** (1992), 173–186.
- [13] J.M. Belley and F. Vaillancourt, *Variational methods and the nonconservative pendulum equation with periodic forcing*, to appear.
- [14] A.S. Besicovitch, *Almost Periodic Functions*, Cambridge Univ. Press, Cambridge (1932). Reprinted: Dover, New York (1954).
- [15] G.D. Birkhoff, *Proof of Poincaré's last geometric theorem*, Trans. Amer. Math. Soc. **14** (1913), 14–22.
- [16] G.D. Birkhoff, *On the periodic motions of dynamical systems*, Acta Math. **50** (1927), 359–379.
- [17] J. Blot, *Une méthode hilbertienne pour les trajectoires presque périodiques*, C. R. Acad. Sci. Paris, Ser. I Math. **313** (1991), 487–490.
- [18] J. Blot, *Almost periodically forced pendulum*, Funkcialaj Ekvacioj **36** (1993), 235–250.
- [19] J. Blot, P. Cieutat and J. Mawhin, *Almost periodic oscillations of monotone second order systems*, Adv. Differential Equations **2** (1997), 693–714.
- [20] J. Blot and D. Pennequin, *Spaces of quasi-periodic functions and oscillations in differential equations*, Acta Appl. Math. **65** (2001), 83–113.
- [21] E. Bosetto and E. Serra, *A variational approach to chaotic dynamics in periodically forced nonlinear oscillators*, Ann. Inst. H. Poincaré, Anal. Non Linéaire **17** (2000), 673–709.
- [22] E. Bosetto, E. Serra and S. Terracini, *Density of chaotic dynamics in periodically forced pendulum-type equations*, Atti Accad. Lincei Cl. Sci. Fis. Mat. Natur. Rend. Mat. Appl. (9) **12** (2001), 107–113.
- [23] E. Bosetto, E. Serra and S. Terracini, *Generic-type results for chaotic dynamics in equations with periodic forcing terms*, J. Differential Equations **180** (2002), 99–124.
- [24] R. Bott, *On the intersection of a closed geodesics and Sturm intersection theory*, Comm. Pure Appl. Math. **9** (1956), 176–206.
- [25] M. Calanchi and E. Serra, *Homoclinic solutions to periodic motions in a class of reversible equations*, Calculus Variations Partial Differential Equations **9** (1999), 157–184.
- [26] M. Calanchi and M. Tarallo, *On the count and the classification of periodic solutions to forced pendulum type equations*, Differential Integral Equations **11** (1998), 503–520.
- [27] J. Campos, E.N. Dancer and R. Ortega, *Dynamics in the neighbourhood of a continuum of fixed points*, Ann. Mat. Pura Appl. (4) **180** (2002), 483–492.

- [28] A. Cañada and D. Ruiz, *Resonant problems with multidimensional kernel and periodic nonlinearities*, *Differential Integral Equations* **16** (2003), 499–512.
- [29] A. Cañada and D. Ruiz, *Resonant nonlinear boundary value problems with almost periodic nonlinearity*, *Bull. Belgian Math. Soc.* **9** (2002), 193–204.
- [30] A. Cañada and A. Ureña, *An asymptotic result on the solvability of pendulum-type equations with linear damping and homogeneous Dirichlet conditions*, *Proc. USA–Chile Workshop on Nonlinear Analysis (Viña del Mar–Valparaíso, 2000)*, *Electron. J. Differential Equations Conf.* **6** (2001), 55–64.
- [31] A. Cañada and A. Ureña, *Solvability of some pendulum-type equations with linear damping and homogeneous Dirichlet conditions*, *Nonlinear Anal.* **49** (2002), 1149–1165.
- [32] A. Castro, *Periodic solutions of the forced pendulum equation*, *Differential Equations*, Ahmad, Keener, Lazer, eds., Academic Press, New York (1980), 149–160.
- [33] J. Čepička, P. Drábek and J. Jenšíková, *On the stability of periodic solutions of the damped pendulum equation*, *J. Math. Anal. Appl.* **209** (1997), 712–723.
- [34] K.C. Chang, *On the periodic nonlinearity and the multiplicity of solutions*, *Nonlinear Anal.* **13** (1989), 527–537.
- [35] A. Chenciner, *La dynamique au voisinage d'un point fixe elliptique conservatif : de Poincaré et Birkhoff à Aubry et Mather*, *Séminaire Bourbaki No. 622, Astérisque, Vols. 121–122* (1985), 147–170.
- [36] E.N. Dancer, *On the use of asymptotics in nonlinear boundary value problems*, *Ann. Mat. Pura Appl.* (4) **131** (1982), 167–185.
- [37] E.N. Dancer and R. Ortega, *The index of Lyapunov stable fixed points in two dimensions*, *J. Dynamics Differential Equations* **6** (1994), 631–637.
- [38] J. Denzler, *Mather sets for plane Hamiltonian systems*, *J. Appl. Math. Phys. (ZAMP)* **38** (1987), 791–812.
- [39] Weiyue Ding, *A generalization of the Poincaré–Birkhoff theorem*, *Proc. Amer. Math. Soc.* **88** (1983), 341–346.
- [40] F. Donati, *Sur l'existence de quatre solutions périodiques pour l'équation du pendule forcé*, *C. R. Acad. Sci. Paris I* **317** (1993), 667–672.
- [41] F. Donati, *Some remarks about periodic solutions to the forced pendulum equation*, *Differential Integral Equations* **8** (1995), 141–149.
- [42] Yihong Du, *A deformation lemma and some critical point theorems*, *Bull. Austral. Math. Soc.* **43** (1991), 161–168.
- [43] A.M. Fink, *Uniqueness theorems and almost periodic solutions to second order differential equations*, *J. Differential Equations* **4** (1968), 543–548.
- [44] A.M. Fink, *Almost Periodic Differential Equations*, *Lecture Notes in Math.*, Vol. 377, Springer, Berlin (1974).
- [45] A. Fonda and M. Willem, *Subharmonic oscillations of forced pendulum-type equations*, *J. Differential Equations* **81** (1989), 215–220.
- [46] A. Fonda and F. Zanolin, *Periodic oscillations of forced pendulums with very small length*, *Proc. Roy. Soc. Edinburgh A* **127** (1997), 67–76.
- [47] G. Fournier and J. Mawhin, *On periodic solutions of forced pendulum-like equations*, *J. Differential Equations* **60** (1985), 381–395.
- [48] G. Fournier, A. Szulkin and M. Willem, *Semilinear elliptic equations in R^N with almost periodic or unbounded forcing term*, *SIAM J. Math. Anal.* **27** (1996), 1653–1660.
- [49] S. Fučík, *Solvability of Nonlinear Equations and Boundary value Problems*, Reidel, Dordrecht (1980).
- [50] R.E. Gaines and J. Mawhin, *Coincidence Degree and Nonlinear Differential Equations*, *Lecture Notes in Math.*, Vol. 568, Springer, Berlin (1977).
- [51] N. Ghoussoub and D. Preiss, *A general mountain pass principle for locating and classifying critical points*, *Ann. Inst. H. Poincaré Anal. Non Linéaire* **6** (1989), 321–330.
- [52] P. Girg and F. Roca, *On the range of certain pendulum-type equation*, *J. Math. Anal. Appl.* **249** (2000), 127–149.
- [53] L. Guillou, *Théorème de translation plane de Brouwer et généralisations du théorème de Poincaré–Birkhoff*, *Topology* **33** (1994), 331–351.
- [54] P. Habets and P.J. Torres, *Some multiplicity results for periodic solutions of a Rayleigh differential equation*, *Dyn. Contin. Discrete Impuls. Syst. Ser. A Math. Anal.* **8** (2001), 335–351.
- [55] G. Hamel, *Ueber erzwungene Schwingungen bei endlichen Amplituden*, *Math. Ann.* **86** (1922), 1–13.

- [56] Hai Huang, *Destruction of invariant tori in pendulum-type equations*, J. Differential Equations **146** (1998), 67–89.
- [57] Hai Huang, *Generic existence of invariant Cantori in pendulum-type equations*, J. Math. Anal. Appl. **218** (1998), 379–394.
- [58] Hai Huang, *Unbounded solutions of almost-periodically forced pendulum-type equations*, Acta Math. Sinica (Engl. Ser.) **17** (2001), 391–396.
- [59] Hai Huang and Rong Yuan, *Boundedness of solutions and existence of invariant tori for generalized pendulum type equations*, Chinese Sci. Bull. **42** (1997), 1673–1675.
- [60] R. Kannan and R. Ortega, *Periodic solutions of pendulum-type equations*, J. Differential Equations **59** (1985), 123–144.
- [61] R. Kannan and R. Ortega, *An asymptotic result in forced oscillations of pendulum-type equations*, Appl. Anal. **22** (1986), 45–54.
- [62] A. Katok and B. Hasselblatt, *Introduction to the Modern Theory of Dynamical Systems*, Cambridge Univ. Press, Cambridge (1995).
- [63] G. Katriel, *Many periodic solutions for pendulum-type equations*, Nonlinear Anal. **34** (1998), 687–699.
- [64] G. Katriel, *Periodic solutions of the forced pendulum: exchange of stability and bifurcation*, J. Differential Equations **182** (2002), 1–50.
- [65] M. Levi, *KAM theory for particles in periodic potential*, Ergodic Theory Dynamical Systems **10** (1990), 777–785.
- [66] M. Levi, *Invariant foliations in forced oscillations*, Geometry and Analysis in Nonlinear Dynamics, Broer-Takens, ed., Longman, London (1992), 34–40.
- [67] M. Levi and E. Zehnder, *Boundedness of solutions for quasiperiodic potentials*, SIAM J. Math. Anal. **26** (1995), 1233–1256.
- [68] P. Martinez-Amores, J. Mawhin, R. Ortega and M. Willem, *Generic results for the existence of nondegenerate periodic solutions of some differential systems with periodic nonlinearities*, J. Differential Equations **91** (1991), 138–148.
- [69] J.N. Mather, *Existence of quasi-periodic orbits for twist homeomorphisms of the annulus*, Topology **21** (1982), 457–467.
- [70] J.N. Mather, *Modulus of continuity for Peierl's barrier*, Periodic Solutions of Hamiltonian Systems and Related Topics, P.H. Rabinowitz, et al., eds., NATO ASI Series C, Vol. 209, Reidel, Dordrecht (1987), 177–202.
- [71] J.N. Mather, *Destruction of invariant circles*, Ergodic Theory Dynamical Systems **8**^{*} (1988), 199–214.
- [72] J.N. Mather, *Variational construction of orbits for twist diffeomorphisms*, J. Amer. Math. Soc. **4** (1991), 203–267.
- [73] J.N. Mather and G. Forni, *Action minimizing orbits in Hamiltonian systems*, Transition to Chaos in Classical and Quantum Mechanics, Lecture Notes in Math., Vol. 1589, Springer, Berlin (1994), 92–186.
- [74] J. Mawhin, *Topological Degree Methods in Nonlinear Boundary Value Problems*, Amer. Math. Soc., Providence, RI (1979).
- [75] J. Mawhin, *Periodic oscillations of forced pendulum-like equations*, Lecture Notes in Math., Vol. 964, Springer, Berlin (1982), 458–476.
- [76] J. Mawhin, *Points fixes, points critiques et problèmes aux limites*, Presses Univ. Montréal, Montréal (1985).
- [77] J. Mawhin, *The forced pendulum: a paradigm for nonlinear analysis and dynamical systems*, Exposition Math. **6** (1988), 271–287.
- [78] J. Mawhin, *Forced second order conservative systems with periodic nonlinearity*, Ann. Inst. H. Poincaré Anal. Non Linéaire Suppl. **6** (Special issue dedicated to J.J. Moreau) (1989), 415–434.
- [79] J. Mawhin, *Nonlinear oscillations: one hundred years after Liapunov and Poincaré*, Z. Angew. Math. Mech. **73** (1993), T54–T62.
- [80] J. Mawhin, *Bounded solutions of nonlinear ordinary differential equations*, Nonlinear Analysis and Boundary Value Problems for Ordinary Differential Equations, CISM Courses and Lectures, Vol. 371, Udine 1995, Zanolin, ed., Springer, Wien (1996), 121–147.
- [81] J. Mawhin, *Remarques sur les solutions bornées ou presque périodiques de l'équation du pendule forcé*, Ann. Sci. Math. Québec **22** (1998), 213–224.
- [82] J. Mawhin, *Seventy-five years of global analysis around the forced pendulum equation*, Equadiff 9 Proceedings, Masaryk Univ. Brno and Electronic Publ. House, Stony Brooks (1998), 115–145.

- [83] J. Mawhin, *From Tricomi's equation for synchronous motors to the periodically forced pendulum*, Tricomi's Ideas and Contemporary Applied Mathematics (Roma–Torino, 1997), Atti dei Convegni Lincei **147**, Accad. Naz. Lincei, Roma (1998), 251–269.
- [84] J. Mawhin, *Bounded and almost periodic solutions of nonlinear differential equations: variational vs. nonvariational approach*, Calculus of Variations and Differential Equations (Technion, 1998), A. Ioffe, S. Reich and I. Shafrir, eds., Res. Notes Math., Vol. 410, Chapman and Hall/CRC, Boca Raton (1999), 167–184.
- [85] J. Mawhin and M. Willem, *Multiple solutions of the periodic boundary value problem for some forced pendulum-type equations*, J. Differential Equations **52** (1984), 264–287.
- [86] J. Mawhin and M. Willem, *Critical Point Theory and Hamiltonian Systems*, Springer, New York (1989).
- [87] J. Moser, *Stable and Random Motions in Dynamical Systems*, Ann. Math. Studies, Vol. 77, Princeton Univ. Press, Princeton (1973).
- [88] J. Moser, *Monotone twist mappings and the calculus of variations*, Ergodic Theory Dynamical Systems **6** (1986), 401–413.
- [89] J. Moser, *Minimal solutions of variational problems on the torus*, Ann. Inst. H. Poincaré, Anal. Non Linéaire **3** (1986), 229–272.
- [90] J. Moser, *Recent developments in the theory of Hamiltonian systems*, SIAM Rev. **28** (1986), 459–485.
- [91] J. Moser, *Breakdown of stability*, Lecture Notes in Phys., Vol. 247, Springer, Berlin (1986), 492–518.
- [92] J. Moser, *Minimal foliations on a torus*, Topics in Calculus of Variations, CIME Montecatini 1987, Lecture Notes in Math., Vol. 1365, Springer (1989), 62–99.
- [93] J. Moser, *A stability theory for minimal foliations on a torus*, Ergodic Theory Dynamical Systems **8*** (1988), 251–288.
- [94] J. Moser, *Quasi-periodic solutions of nonlinear elliptic partial differential equations*, Bol. Soc. Brasil. Mat. **20** (1989), 29–45.
- [95] J. Moser, *Selected Chapters in the Calculus of Variations*, Lectures in Math. ETH Zürich, Birkhäuser, Basel (2003).
- [96] D. Offin, *Subharmonic oscillations for forced pendulum type equations*, Differential Integral Equations **3** (1990), 965–972.
- [97] D. Offin and Yu Hongan, *Homoclinic orbits in the forced pendulum system*, Conservative Systems and Quantum Chaos (Waterloo, ON, 1992), Fields Inst. Commun., Vol. 8, Amer. Math. Soc., Providence, RI (1996) 1–18.
- [98] Z. Opial, *Sur les intégrales bornées de l'équation $u'' = f(t, u, u')$* , Ann. Polon. Math. **4** (1958), 314–324.
- [99] R. Ortega, *A counterexample for the damped pendulum equation*, Bull. Cl. Sci. Acad. R. Belgique (5) **73** (1987), 405–409.
- [100] R. Ortega, *Stability and index of periodic solutions of an equation of Duffing type*, Boll. Un. Mat. Ital. (7) **3B** (1989), 533–546.
- [101] R. Ortega, *Topological degree and stability of periodic solutions for certain differential equations*, J. London Math. Soc. (2) **42** (1990) 505–516.
- [102] R. Ortega, *Some applications of the topological degree to stability theory*, Topological Methods in DEs and Inclusions, Kluwer, Dordrecht (1995), 377–409.
- [103] R. Ortega, *A boundedness result of Landesman–Lazer type*, Differential Integral Equations **8** (1995), 729–734.
- [104] R. Ortega, *A forced pendulum equation with many periodic solutions*, Rocky Mountain J. Math. **27** (1997), 861–876.
- [105] R. Ortega, *The number of stable periodic solutions of time-dependent Hamiltonian systems with one degree of freedom*, Ergodic Theory Dynamical Systems **18** (1998), 1007–1018.
- [106] R. Ortega, *Counting periodic solutions of the forced pendulum equation*, Nonlinear Anal. **42** (2000), 1055–1062.
- [107] R. Ortega, E. Serra and M. Tarallo, *Non-continuation of the periodic oscillations of a forced pendulum in the presence of friction*, Proc. Amer. Math. Soc. **128** (2000), 2659–2665.
- [108] R. Ortega and M. Tarallo, *Degenerate equations of pendulum-type*, Comm. Contemporary Math. **2** (2000), 127–149.
- [109] R. Ortega and M. Tarallo, *Almost periodic upper and lower solutions*, to appear.

- [110] I.C. Percival, *Variational principles for the invariant toroids of classical dynamics*, J. Phys. A **7** (1974), 794–802.
- [111] I.C. Percival, *A variational principle for invariant tori of fixed frequency*, J. Phys. A **12** (1979), L57–L60.
- [112] H. Poincaré, *Sur un théorème de géométrie*, Rend. Circ. Mat. Univ. Palermo **33** (1912), 375–407.
- [113] P. Pucci and J. Serrin, *Extensions of the mountain pass theorem*, J. Functional Anal. **59** (1984), 185–210.
- [114] P. Rabinowitz, *On a class of functionals invariant under a Z_n action*, Trans. Amer. Math. Soc. **310** (1988), 303–311.
- [115] P. Rabinowitz, *Heteroclinics for a reversible Hamiltonian system*, Ergodic Theory Dynamical Systems **14** (1994), 817–829.
- [116] P. Roselli, *A multiplicity result for the periodically forced N -pendulum with nonzero mean valued forcings*, Nonlinear Anal. **43** (2001), 1019–1041.
- [117] R.Z. Sagdeev, P.A. Usikov and G.M. Zaslavsky, *Nonlinear Physics: from the Pendulum to Turbulence and Chaos*, Harwood Acad. Publ., Chur (1988).
- [118] R. Schaaf and K. Schmitt, *A class of nonlinear Sturm–Liouville problems with infinitely many solutions*, Trans. Amer. Math. Soc. **306** (1988), 853–859.
- [119] E. Serra and M. Tarallo, *A reduction method for periodic solutions of second order subquadratic equations*, Adv. Differential Equations **3** (1998), 199–226.
- [120] E. Serra and M. Tarallo, *A unified approach to boundary value problems at resonance with the first eigenvalue*, Proc. Int. Conf. Dynamical Systems Differential Equations (Springfield, MO, 1996), Discrete Contin. Dynam. Systems, Added Vol. II (1998), 182–195.
- [121] E. Serra, M. Tarallo and S. Terracini, *On the structure of the solution set of forced pendulum-type equations*, J. Differential Equations **131** (1996), 189–208.
- [122] E. Serra, M. Tarallo and S. Terracini, *Subharmonic solutions to second order differential equations with periodic nonlinearities*, Nonlinear Anal. **41** (2000), 649–667.
- [123] G. Tarantello, *On the number of solutions for the forced pendulum equations*, J. Differential Equations **80** (1989), 79–93.
- [124] A. Tineo, *An iterative scheme for the N -competing species problem*, J. Differential Equations **116** (1995), 1–15.
- [125] F. Tricomi, *Sur une équation différentielle de l'électrotechnique*, C. R. Acad. Sci. Paris **193** (1931), 635–636.
- [126] F. Tricomi, *Integrazione di un equazione differenziale presentatasi in elettrotecnica*, Ann. R. Scuola Norm. Sup. Pisa **2** (1933), 1–20.
- [127] A.J. Ureña, *On the multiplicity of—up to constants—periodic solutions for dissipative pendulum-type equations*, to appear.
- [128] J.R. Ward Jr., *A boundary value problem with a periodic nonlinearity*, Nonlinear Anal. **10** (1986), 207–213.
- [129] M. Willem, *Oscillations forcées de l'équation du pendule*, Pub. IRMA Lille **3** (1981), V1–V3.
- [130] Jiangong You, *Invariant tori and Lagrange stability of pendulum-type equations*, J. Differential Equations **85** (1990), 54–65.
- [131] Jiangong You, *Periodic solutions to pendulum type equations*, Nanjing Daxie Xuebao Shuxue Bannian Kan **7** (1990), 218–222 (in Chinese).
- [132] Jiangong You, *Boundedness of solutions and existence of quasiperiodic solutions for a non-conservative pendulum-type equation*, Chinese Science Bull. **21** (1991), 1606–1609.
- [133] Jiangong You, *Global attraction of forced pendulum equations with positive damping*, Acta Math. Sinica **34** (1991), 690–695 (in Chinese).
- [134] Jiangong You, *Boundedness for solutions of non-conservative pendulum-type equations*, Preprint.
- [135] S.F. Zakharin and I.O. Parasyuk, *Forced almost periodic oscillations of a pendulum and their extremal properties* (in Ukrainian), Dopov. Nats. Akad. Nauk Ukr. Mat. Prirodozn. Tekh. Nauki **6** (1998), 19–21

This Page Intentionally Left Blank

Ważewski Method and Conley Index

Roman Srzednicki*

Institute of Mathematics, Jagiellonian University, ul. Reymonta 4, 30-059 Kraków, Poland

E-mail: srzednic@im.uj.edu.pl

Contents

1. Introduction	593
1.1. Historical background of topological methods	593
1.2. An outline of the Ważewski method in a historical context	594
1.3. On the origin of the Conley index theory	600
1.4. Review of the current exposition	601
2. Ważewski method for local semiflows and flows	602
2.1. Local semiflows and Ważewski sets	602
2.2. Properties of Ważewski sets	605
2.3. Versions of the Ważewski theorem	606
3. Ważewski method in ordinary differential equations and inclusions	610
3.1. Polyfacial sets	610
3.2. Equations without the uniqueness property and differential inclusions	614
3.3. Weak inequalities in polyfacial sets	616
3.4. Generalized polyfacial sets	617
4. Ważewski method for retarded functional differential equations	620
4.1. Local semiflows generated by RFDEs	620
4.2. Ważewski-type theorems for RFDEs	621
5. Some topological concepts	626
5.1. Topological pairs, quotient spaces, and pointed spaces	626
5.2. Homotopy types	627
5.3. Absolute neighborhood retracts	629
5.4. Lusternik–Schnirelmann category	630
5.5. Cup-length	632
5.6. Lefschetz theorem and the fixed point index	634
6. Properties of the asymptotic parts of Ważewski sets	636
6.1. Estimates on the category of the asymptotic part	636
6.2. Stationary points of gradient-like local semiflows	637
6.3. Stationary points of local semiflows in the general case	637
7. Isolating blocks and segments	638

*Supported by KBN, grant 2 P03A 041 24.

7.1. Isolating blocks and their structure	638
7.2. Estimates on the cohomology of the invariant part	642
7.3. On the number of stationary points of gradient-like flows	648
7.4. Fixed point index and the index of stationary points	651
7.5. Isolating segments	652
8. Selected applications of the Ważewski method	658
8.1. Asymptotic solutions	659
8.2. Two-point boundary value problems	662
8.3. Detection of chaotic dynamics	664
9. Conley index	667
9.1. Isolated invariant sets and the Conley index	667
9.2. Properties of the Conley index	671
9.3. Examples of Conley indices and an application	675
9.4. Concluding remarks	680
References	680

1. Introduction

The main subject of this note is the *retract method* introduced by Tadeusz Ważewski. It is a method of proving the existence of solutions which remain in a given set and refers to differential equations describing some evolution in time. The sets under consideration should satisfy the condition “all egress points are strict” or its less restrictive variant. Now they are called *Ważewski sets*. The method is based on theorems which roughly assert that there is a solution contained a Ważewski set for all positive values of time if the subset of egress points is not a retract of the whole set (which explains the name of the method). If, moreover, the set is compact then its *invariant part* (i.e., the set of full solutions contained in it) is nonempty. For *isolating blocks*, i.e., compact Ważewski sets which do not contain any full solutions intersecting their boundaries, Charles Conley discovered a homotopical invariant which provides a quantitative information on their invariant parts. It is called the *Conley index*. The Conley index theory, both from a point of view of continuous and discrete-time dynamical systems, was presented by Mischaikow and Mrozek in Chapter 9 of *Handbook of Dynamical Systems*, vol. 2, within the current series of handbooks edited by Elsevier Science B.V. (see [50]).

In this note we describe the Ważewski method in details and provide an information on foundations of the Conley index theory which directly relates to the method and essentially does not overlap with the exposition of Mischaikow and Mrozek. We begin with a short introduction to the method and to the theory related to the index in a historical context.

1.1. Historical background of topological methods

The modern understanding of mechanics begins since the fundamental research of Newton in the XVII century. In order to formulate the rules of motion, Newton introduced the concept of differential equation. The equations which appear in mechanics belong mainly to the class of ordinary differential equations. They are characterized by a distinguished parameter interpreted as time and, if some regularity conditions are imposed, the initial data determine the whole solution. It was clear from the beginning that in general one cannot find analytical formulas for such solutions. Instead of rigorous description, numerical methods usually provide satisfactory approximations of solutions in bounded time-intervals. Possibility of calculation of such approximations contributed mainly to the successful development of applied mechanics.

However, numerical methods fail in general if one is interested in the global behavior of the solution, i.e., in the whole domain, up to the left and right range of time of its existence. For a given initial data, usually it is impossible to determine whether the solution represents a periodic motion and to predict the asymptotic behavior at the limits of its existence. As it was observed by Henri Poincaré at the end of the XIX century, the behavior of solutions can be very complicated and have a chaotic character, hence one cannot expect to determine the full information on the dynamics generated by a given equation. Even a proof of the existence of a solution with prescribed behavior (periodic, almost-periodic, bounded, chaotic, satisfying some boundary conditions, etc.) is usually a difficult task.

Poincaré initiated systematic studies on the global understanding of solutions and dynamics, which are known under the name of qualitative theory of differential equations, or, in a more general context, theory of dynamical systems. Besides analytical arguments he used methods of topology and algebra. Research on limit cycles and indexes of zeroes of planar vector fields, periodic solutions of Hamiltonian systems (in particular, based on his “twist theorem”), and stability of the Solar system belong to his most known results on that field. He also contributed essentially in the development of variational methods applied to boundary value problems.

One of the greatest achievements of Poincaré was the introduction of algebraic topology (called by him “analysis situs”). Among the results which were proved by its application, there were the fixed point theorems of L.E.J. Brouwer (1912) and Salomon Lefschetz (1923) which found natural applications in the qualitative theory of differential equations. Brouwer introduced also the concept of the degree of a vector-field. A related notion of the fixed point index was invented later by Jean Leray. The Brouwer fixed point theorem and the degree were generalized to the infinite-dimensional case by Juliusz Schauder in 1930 and, respectively, by Leray and Schauder in 1934. Together with variational methods, they form the main tools in proofs of results on existence of solutions of initial and boundary value problems in nonlinear differential equations. The idea of their application consists in suitable choice of an operator acting on a function space in which the original problem reduces to the existence of its fixed point or its zero. In variational methods, the existence of a solution of the problem is equivalent to the existence of a critical point of a suitable functional. An essential progress in development of these methods were done by Marston Morse in 1925 who invented the theory of critical points which now bears his name and by Lusternik and Schnirelmann by their research on the concept of category in 1930. It seems that the next major achievement in topological approach to differential equations was done by Tadeusz Ważewski (1896–1972) by introducing the retract method in the middle of the twentieth century.

1.2. An outline of the Ważewski method in a historical context

The following definition provides the notion of a retract introduced by Karol Borsuk in the paper [13] from 1931. Let X be a topological space and let A be its subset.

DEFINITION 1.1. A continuous map $r : X \rightarrow A$ such that $r(a) = a$ for every $a \in A$ is called a *retraction*. A is called a *retract of X* if there exists a retraction $X \rightarrow A$. A continuous map $r : X \rightarrow A$ is called a *strong deformation retraction* if it is equal to the map $x \mapsto h(x, 1)$, where $h : X \times [0, 1] \rightarrow X$ is a continuous map such that $h(x, 0) = x$ and $h(x, 1) \in A$ for every $x \in X$, and $h(a, t) = a$ for every $a \in A$ and $t \in [0, 1]$. A is called a *strong deformation retract of X* if there exists a strong deformation retraction $X \rightarrow A$.

Obviously, a strong deformation retract is also a retract and a retract of a connected set is also connected. Moreover, it is well known that the Brouwer fixed point theorem is equivalent to the fact that the unit sphere S^{n-1} in \mathbb{R}^n is not a retract of the closed unit ball B^n .

In 1947, Ważewski presented the paper [85] in which he proved a theorem on the existence of solutions which are contained in given set for all positive values of time. In the contemporary used mathematical notation the theorem can be described as follows. Assume that v is a continuous vector-field on M , where M is an open subset of \mathbb{R}^n (it can be a smooth manifold without boundary as well). We refer to M as to the *phase-space*. It is assumed that through each point x_0 of M passes a unique saturated solution $t \mapsto \phi(x_0, t)$ of the Cauchy problem

$$\dot{x} = v(x), \tag{1.1}$$

$$x(0) = x_0. \tag{1.2}$$

The map $\phi: (x, t) \mapsto \phi(x, t)$ is called *local flow*; its purely topological description is provided in Definition 2.1. Let us mention here that usually $\phi(x, t)$ is not defined for all t and by the *trajectory* (respectively, the *positive semitrajectory*, the *negative semitrajectory*) of x we mean the set of all points $\phi(x, t)$ (respectively, the set of all points $\phi(x, t)$ with $t \geq 0$, all points $\phi(x, t)$ with $t \leq 0$) whenever they are defined.

Let V be an open subset of the phase space. Let $x \in \partial V$. Some types of behavior of the trajectory of x with respect to V are described in the following

DEFINITION 1.2. x is called an *egress point* of V if there exists an $\varepsilon > 0$ such that $\phi(x, t) \in V$ for $-\varepsilon < t < 0$. If, moreover, $\phi(x, t) \in \setminus \bar{V}$ for $0 < t < \varepsilon$ then x is called a *strict egress point*. Symmetrically, by reversing t to $-t$, one defines an *ingress point* and a *strict ingress point*. Finally, x is called an *outward tangency point* of V if there exists an $\varepsilon > 0$ such that $\phi(x, t) \in \setminus \bar{V}$ for $t \in (-\varepsilon, \varepsilon)$ and $t \neq 0$.

The points distinguished in the above definition can be visualized on Figure 1, where there are shown fragments of trajectories of some planar equation near the boundary of a square. The open vertical sides of the square consist of strict egress points, the open horizontal sides consists of strict ingress points, and the four vertices form the set of outward tangency points.

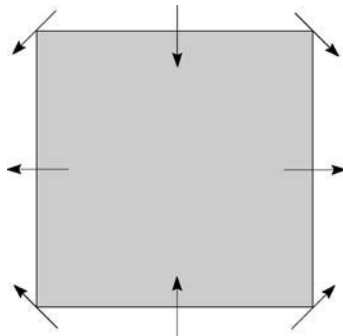

Fig. 1.

Denote by E the set of egress points. There is a distinguished subset V^* of V consisting of points which escape from V in a positive time, i.e., points $x \in V$ for which there exists a $t > 0$ such that $\phi(x, t) \notin V$. For every $x \in V^*$ one can assign the first time in which it gets the boundary of V . That time is called the *escape-time* of x and is denoted by $\sigma(x)$; by definition, it is a positive number such that $\phi(x, [0, \sigma(x))) \subset V$ and $\phi(x, \sigma(x)) \in E$. The latter point is called the *consequent* of x . Both notions are extended to E : for $x \in E$ put $\sigma(x) = 0$ and define the consequent of x as x itself.

Let $Y \subset E$ and let $Z \subset V \cup Y$. The main theorem [85, Theorem 1] is the following:

WAŻEWSKI THEOREM. *If all egress points are strict egress points and*

- $Z \cap Y$ is a retract of Y ,
- $Z \cap Y$ is not a retract of Z

then there exists an $x_0 \in Z$ such that

- *either the positive semitrajectory of x_0 is contained in V*
- *or $x_0 \in V^*$ and the consequent of x_0 belongs to $E \setminus Y$.*

In particular, the second possibility in the conclusion is trivially excluded if $Y = E$ (compare [85, Theorem 2]). If we exchange egress points by ingress points in the statement of the theorem, we obtain a result on the existence of a negative semitrajectory.

Originally, the *Ważewski method* (or the *retract method*) consisted in applications of the theorem in proofs of the existence of solutions representing some special properties, usually referred to its asymptotic behavior. As it was indicated in [85], a suitable choice of the sets Z and Y leads also to proofs of the existence of solutions of some two-point boundary value problems. In [85], Ważewski pointed out also how to drop the assumption on the uniqueness of the Cauchy problem if the considered set Z is compact and V is a *polyfacial set*, which roughly means that it is described by some strong inequalities (compare Sections 3.1 and 3.2).

In the following examples we illustrate the usability of the Ważewski method.

EXAMPLE 1.1. Consider a planar equation given by

$$\begin{aligned} \dot{x} &= f(t, x, y), \\ \dot{y} &= g(t, x, y). \end{aligned} \tag{1.3}$$

in the (x, y) -coordinates. Assume that

$$xf(t, x, y) > 0, \quad \text{if } t \text{ is arbitrary, } |x| = 1, |y| \leq 1, \tag{1.4}$$

$$yg(t, x, y) < 0, \quad \text{if } t \text{ is arbitrary, } |x| \leq 1, |y| = 1. \tag{1.5}$$

After extending the plane by the time variable, (1.3) provides an autonomous equation represented by

$$\dot{t} = 1, \quad \dot{x} = f(t, x, y), \quad \dot{y} = g(t, x, y) \tag{1.6}$$

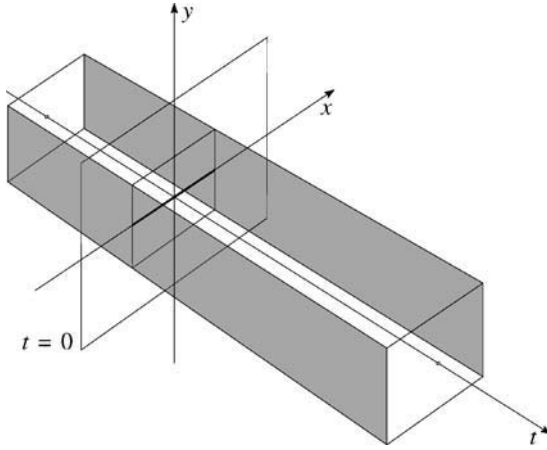

Fig. 2.

in the coordinates of \mathbb{R}^3 . Assume that the uniqueness of the Cauchy problem is guaranteed. Put

$$V := \{(t, x, y) \in \mathbb{R}^3: |x| < 1, |y| < 1\}. \tag{1.7}$$

It is an infinite rectangular tube which part is shown on Figure 2. It follows by the inequalities (1.4) and (1.5) that the set of egress points

$$E := \{(t, x, y) \in \mathbb{R}^3: |x| = 1, |y| < 1\} \tag{1.8}$$

consists of strict egress points. It forms two shaded sides of the tube on the figure. Let

$$Z := \{(0, x, 0) \in \mathbb{R}^3: |x| \leq 1\}, \tag{1.9}$$

i.e., the black bar inside the plane $\{t = 0\}$. It follows that $Z \cap E$ consists of two ends of Z , hence it is not a retract of Z , hence there is a retraction $E \rightarrow Z \cap E$. It follows by the Ważewski theorem that there exists an $x_0, |x_0| < 1$ such that the solution (ϕ, ψ) of (1.3) with $\phi(0) = x_0$ and $\psi(0) = 0$, satisfies

$$|\phi(t)| < 1, \quad |\psi(t)| < 1$$

for each $t \geq 0$.

EXAMPLE 1.2. Consider the boundary-value problem

$$y(0) = x(1) = 0 \tag{1.10}$$

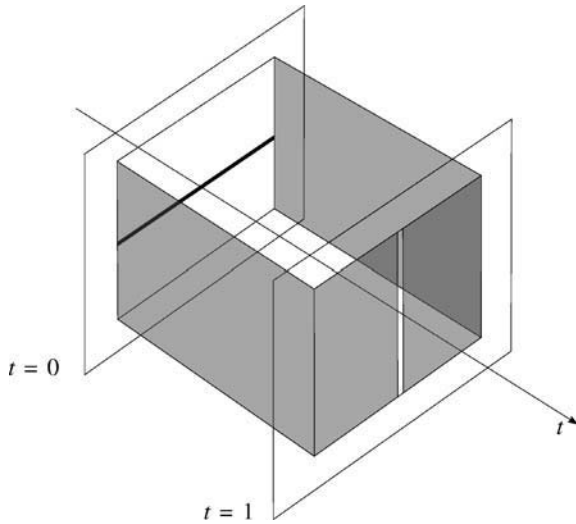

Fig. 3.

associated to (1.3). It means that we are looking for a solution of (1.3) such that its second coordinate at time 0 and the first coordinate at time 1 are equal to zero. In order to solve the problem we consider again the local flow in \mathbb{R}^3 generated by (1.6). Now we put

$$V := \{(t, x, y) \in \mathbb{R}^3: t < 1, |x| < 1, |y| < 1\}. \tag{1.11}$$

The set of egress points of V is equal to

$$E := \{(t, x, y): t \leq 1, |x| = 1, |y| < 1\} \cup \{(1, x, y): |x| \leq 1, |y| < 1\}. \tag{1.12}$$

A fragment of V over the interval $[0, 1]$ is shown on Figure 3. It is the rectangular prism and the corresponding fragment of E consists of its three sides. Let Z be the same as in Example 1.1, i.e., given by (1.9). Put

$$Y := E \setminus \{(1, 0, y): |y| < N\}. \tag{1.13}$$

On the figure, Z is shown as the black bar and Y is represented by the shaded surface. It is easy to see that $Z \cap Y$ is not a retract of Z but it is a retract of Y . It follows by the Ważewski theorem that there exists $x_0 \in (-1, 1)$ such that the solution of (1.6) starting at $(0, x_0, 0)$ either remains in V or intersects $E \setminus Y$. Since $\dot{t} = 1$, the first possibility is ruled out and, moreover, the time in which the solution gets $E \setminus Y$ is equal to 1. Thus it determines the required solution of the boundary value problem (1.3), (1.10).

In the above examples we assumed the uniqueness of solutions of the Cauchy problem associated to (1.3). Actually, that assumption can be dropped and still we can get the exis-

tence of solutions which remain in \bar{V} in Example 1.3 and solve the boundary value problem in Example 1.2. Indeed, if (1.3) does not satisfy the uniqueness property, one can find approximating sequences of smooth functions $\{f_n\}$ and $\{g_n\}$ for f and g , respectively, such that they satisfy the inequalities (1.4) and (1.5). The corresponding solutions obtained for them by the Ważewski theorem are determined by initial points $z_n \in Z$. Their accumulation point z_0 is the initial point of a required solution.

The Ważewski theorem was announced also in [86,87], and later in the proceedings of the Congress of Mathematicians in Amsterdam [89]. Its proof follows easily from a lemma which asserts the continuity of the *consequent map* $V^* \cup E \rightarrow E$ provided the assumption “all egress points are strict” is satisfied (compare [85, Lemma 3]). Actually, the lemma is an immediate consequence of the following fact implicitly stated in the paper:

WAŻEWSKI LEMMA. *If all egress points are strict then the escape-time function*

$$V^* \cup E \ni x \rightarrow \sigma(x) \in [0, \infty)$$

is continuous.

The lemma has important consequences for the homotopy theory methods in differential equations. At present, the name “Ważewski method” refers also to arguments applying Ważewski lemma. Complete proofs of the Ważewski theorem and related results will be presented in Section 2.3.

In the years after publication of [85], the Ważewski method was intensively developed and applied by many authors. Both the assumptions on retraction and egress points in the Ważewski theorem were modified. Improved versions of the theorem using variants of the notion of strong deformation retract were given, among others, in the papers [1,58,62]; the proofs of those versions were based on the Ważewski lemma. In Section 2.3, we provide examples of such results. On the other hand, in [11] Bielecki observed that all results concerning the Ważewski method which are based on the hypothesis “all egress points are strict” can be directly strengthened if strict egress points are replaced by *strong egress points*. (In the above notation, an egress point $x \in E$ is called a strong egress point if for every $t > 0$ there exists $0 < s < t$ such that $\phi(x, s) \notin \bar{V}$.) Later, in [20] (and also in [21]) Charles Conley (1933–1984) presented a version of the Ważewski theorem with a more general and convenient form of that assumption. He introduced the notion of the *exit set* W^- of an arbitrary set W (in a similar way as we defined above the set of strong egress points), and with its use, he defined the concept of *Ważewski set*. We provide its definition later in Section 2.1. At this moment we mention that it is particularly easy to check in one case: if W and W^- are closed then W satisfies the definition of a Ważewski set. Moreover, referring to our previous consideration, the set $V \cup E$ is a Ważewski set provided each egress point is a strong egress point; in that case E is its exit set. The main feature of [21] was the observation that the Ważewski lemma extends to Ważewski sets: the escape-time function $\sigma : x \mapsto \sigma(x)$ defined for points of W such that their positive semitrajectory leaves W , is continuous. (Here, similarly as before, $\sigma(x)$ denotes the first time in which the semitrajectory of x hits W^- .) Our presentation of the results related to the Ważewski theorem in Section 2.3 is inspired by the ideas of Conley.

1.3. On the origin of the Conley index theory

The Ważewski theorem, like the Schauder fixed point theorem is an existence result. Complementary to the Schauder theorem, the Leray–Schauder degree and the fixed point index provide a quantitative information on the number of solutions. In some sense, similar complementary quantitative information on solutions given by the Ważewski method is provided by the *Conley index*, a topological invariant related to Ważewski sets of a special form, called *isolating blocks*. By an isolating block we mean a compact subset B of the phase space of a local flow ϕ such that $B = \overline{\text{int } B}$ and every $x \in \partial B$ is either a strict egress point, or a strict ingress point, or a point of outward tangency of $\text{int } B$ (its definition is stated in Section 7.1 in a slightly more general form). An example of isolating block is shown on Figure 1. For an isolating block B , its exit set B^- consists of all strict egress and outward tangency points. Because of the compactness of B , if some positive semitrajectory is contained in B then its limit set is nonempty and also contained in B . Since the limit set is invariant, it is contained in the invariant part of B

$$\text{Inv}(B) := \{x \in B: \phi(x, t) \in B \forall t\}$$

which is nonempty in this case. The set $\text{Inv}(B)$ is an example of an *isolated invariant set*, i.e., a compact set which is maximal invariant in some of its neighborhood. (Obviously, the block itself is such a neighborhood for $\text{Inv}(B)$.) In the above sense, isolating blocks have several other nice properties due to symmetry with respect to reversing the time-axis. (Sometimes they are defined only as compact Ważewski sets which are simultaneously isolating neighborhoods.)

The first extensive research on isolating blocks for smooth flows appeared in 1971 in the paper [22] by Conley and Richard Easton. In that paper an important theorem was proved:

FIRST CONLEY THEOREM. *Each isolated invariant set is an invariant part of some isolating block.*

Also in 1971, Conley announced another important theorem (compare [19]):

SECOND CONLEY THEOREM. *If S is an isolated invariant set then the homotopy type $[B/B^-, *]$ of the pointed space obtained from B by collapsing B^- to a point $*$, does not depend on the choice of an isolating block B such that $S = \text{Inv}(B)$.*

(We refer to Section 5.2 for rigorous definitions of the notions involved in that statement.) A proof of the second Conley theorem appeared later in [18] (on the Čech cohomology level only) and in [21] in the full generality. Both the theorems ensure the correctness of the following

DEFINITION 1.3. The *Conley index* of an isolated invariant set S , denoted by $h(\phi, S)$, is defined as the homotopy type $[B/B^-, *]$ for an arbitrary isolating block B having S as the invariant part.

In the Conley's publications the index appeared under the names *homotopy index* and *generalized Morse index*. The origin of the later name is the Morse theory. If $f : M \rightarrow \mathbb{R}$ is a Morse function and ϕ is the (local) flow generated by the gradient equation

$$\dot{x} = -\nabla f(x)$$

then each critical point x_0 of f is also an isolated invariant set for ϕ and its Conley index $h(\phi, \{x_0\})$ is equal to the homotopy type of the pointed k -dimensional sphere S^k , where k is the Morse index of x_0 . (Recall that the Morse index is defined as the number of negative eigenvalues of the Hessian of f at x_0 .) Thanks to the above relation between the indexes, some results of the Morse theory were extended to the theory of isolated invariant sets.

A simple application of the Ważewski lemma leads to the conclusion that if $h(\phi, S)$ is nontrivial (i.e., it is not the homotopy type of a one-point space) then S is nonempty. The converse is not true in general (see Example 9.5) and in this respect the Conley index is not a better tool than the Ważewski method. The Conley index has the additivity and multiplicativity properties, which explain in which sense it "counts" solutions in S . The main advantage of the index is its continuation property: two isolated invariant sets (with respect to possibly different flows) which can be linked by a kind of homotopy, have the same Conley indices. This property is in an analogy to the homotopy properties of the Brouwer and Leray–Schauder degrees, and the fixed point index. It enables calculation of the index in a complicated system by its continuation to a simpler one.

1.4. Review of the current exposition

Our exposition is rather self-contained; we present almost all necessary definitions and we prove a majority of the stated results, although in a few cases we provide sketches of proofs only.

In Section 2, we define the Ważewski set (Definition 2.4), state its main properties (Lemma 2.1) and state strong versions of the Ważewski theorem: Theorem 2.1 valid for local semiflows and Theorem 2.2, based on the notion of quasi-isotopic deformation retract (Definition 2.7), valid for local flows. Section 3 presents methods of construction of Ważewski sets for ordinary differential equations. In particular, so-called polyfacial sets and generalized polyfacial sets are defined (Definitions 3.1 and 3.4). Moreover, a version of the Ważewski theorem for equations without the uniqueness property and differential inclusions is stated (Theorem 3.1). The Ważewski method for local semiflows generated by retarded functional differential equations is described in Section 4, where the corresponding main results are Theorems 4.1 and 4.2. Some topological concepts are recalled in Section 5. They include the notions of the quotient space (Definition 5.1), the absolute and pointed homotopy types (Definition 5.2), absolute neighborhood retract (Definition 5.3), relative Lusternik–Schnirelmann category (Definition 5.6), and cup length (Definition 5.9). Moreover, we recall the Lefschetz fixed point theorem (Proposition 5.6) and properties of the fixed point index (Proposition 5.7). In Section 6, we provide some general results on properties of the sets of solutions given by the Ważewski method. In particular, Theorem 6.1 estimates their category and Theorem 6.2 is a result on the existence of stationary points.

Section 7 presents the notion of isolating block (Definition 7.1) and its topological properties. The related results on the category (Theorem 7.1), exact sequences (Theorem 7.3), cup-length (Theorem 7.4), stationary points of gradient-like local flows (Theorem 7.5), and fixed point index (Theorem 7.6) are given. Moreover, we define the notion of an isolating segment (Definition 7.4) and we prove Theorem 7.7, a related to that notion result on the fixed point index of the evolutionary map. In Section 8, we present three applications of results stated in previous sections. The first of them, Theorem 8.1, generalizes a result of Perron on linear equations, the second one is a result on the existence of solutions of two-point boundary value problems under the classical Bernstein–Nagumo condition (Theorem 8.2), and the last one is a result on the existence of chaotic dynamics (Theorem 8.3). An introduction to the Conley index theory is contained in Section 9. Definition 9.1 provides the notion of an isolated invariant set, Theorems 9.1 and 9.2 of Conley lead to the definition of the index, and properties of the index are stated in Theorems 9.3 and 9.4. Some calculations of the index are given in Propositions 9.1 and 9.2, and an example of its applications is given in the proof of Proposition 9.3. Finally, in Section 9.4 we indicate extensions and improvements of the Conley index.

The bibliography contains positions which usually directly refer to topics presented in this note and by far it does not pretend to be the complete list of books and articles on the Ważewski method and the Conley index. We point out that biographical information on Tadeusz Ważewski and Charles Conley can be found in the articles [54] and, respectively, [47].

2. Ważewski method for local semiflows and flows

In this section we introduce the notion of a Ważewski set and we prove Ważewski type theorems in an abstract topological setting. For this reason we begin with the definitions of the basic concepts of the theory of continuous-time dynamical systems.

2.1. Local semiflows and Ważewski sets

Let X be a topological space.

DEFINITION 2.1. A *local semiflow* on X is a continuous map $\phi : D \rightarrow X$, where D is an open subset of $X \times [0, \infty)$ such that for every $x \in X$ the set $\{t \in [0, \infty) : (x, t) \in D\}$ is equal to an interval $[0, \omega_x)$ for some $0 < \omega_x \leq \infty$, if $t \in [0, \omega_x)$ then $\omega_{\phi(x,t)} = \omega_x - t$ and the following equations hold:

$$\phi(x, 0) = x, \tag{2.1}$$

$$\phi(x, s + t) = \phi(\phi(s, x), t). \tag{2.2}$$

If $D = X \times [0, \infty)$ then ϕ is called a *semiflow*.

A *local flow* is again a continuous map $\phi : D \rightarrow X$, but now D is an open subset of $X \times \mathbb{R}$, for every $x \in X$ the set $\{t : (x, t) \in D\}$ is equal to an open interval (α_x, ω_x) , where

$$-\infty \leq \alpha_x < 0 < \omega_x \leq \infty,$$

if $t \in (\alpha_x, \omega_x)$ then $\alpha_{\phi(x,t)} = \alpha_x - t$ and $\omega_{\phi(x,t)} = \omega_x - t$, and Equations (2.1) and (2.2) hold. Finally, if $D = X \times \mathbb{R}$ then a local flow is called a *flow*.

Obviously, a restriction of a local flow $D \rightarrow X$ to $D \cap (X \times [0, \infty))$ is a local semiflow. Ordinary differential equations generate local flows in a well-known way provided they are autonomous and satisfy the uniqueness condition for solutions of the Cauchy problem. In a similar way retarded functional differential equations (compare Section 4.1) and semilinear parabolic equations generate local semiflows.

In the sequel we frequently use the following notation: we write $\phi_t(x)$ instead of $\phi(x, t)$ and if $A \subset X$ and $J \subset \mathbb{R}$ then we write $\phi(A, J)$ instead of $\phi(A \times J)$.

In the following definitions we assume that ϕ is a local semiflow on X . Let $x \in X$.

DEFINITION 2.2. The set

$$\phi^+(x) := \phi(x, [0, \omega_x))$$

is called the *positive semitrajectory* of x . If, moreover, ϕ is a local flow then the sets

$$\phi(x) := \phi(x, (\alpha_x, \omega_x)),$$

$$\phi^-(x) := \phi(x, (\alpha_x, 0])$$

are called, respectively, the *trajectory* and the *negative semitrajectory* of x .

A map $\sigma : \mathbb{R} \rightarrow X$ such that

$$\sigma(0) = x, \quad \phi_t(\sigma(\tau)) = \sigma(t + \tau).$$

is called a *full solution through x* . A set $A \subset X$ is called *invariant* if for each $x \in A$ there exists a full solution σ through x such that $\sigma(\mathbb{R}) \subset A$. The ω -*limit set* of x is defined as

$$\omega(x) := \bigcap_{s \in [0, \omega_x)} \overline{\phi(x, [s, \omega_x))}.$$

Obviously, if σ is a full solution through x then $\sigma(\tau) = \phi_\tau(x)$ for $\tau \geq 0$ in the case of a local semiflow and for $\tau \in \mathbb{R}$ in the case of a local flow. If x is a *stationary point* (i.e., $\phi^+(x) = \{x\}$) then the constant map $t \mapsto x$ is a full solution through x . More general, if x is a *periodic point* (i.e., $\phi_T(x) = x$ for some $T > 0$) then the periodic extension of $t \mapsto \phi_t(x)$ from $[0, T]$ to the whole \mathbb{R} is also a full solution. It is easy to prove that if $\omega(x) \neq \emptyset$ then necessarily $\omega_x = \infty$ and $\omega(x)$ is invariant.

Let ϕ be a local semiflow on X and let $W \subset X$. Two subsets of W are distinguished:

$$W^- := \{x \in W : \phi(x, [0, t]) \not\subset W \ \forall t > 0\},$$

$$W^* := \{x \in W : \exists t > 0 : \phi_t(x) \notin W\}.$$

DEFINITION 2.3. W^- is called the *exit set* of W . The complement of W^* in W , i.e., the set $W \setminus W^*$ is called the *asymptotic part* of W .

Clearly, $W^- \subset W^*$ and $W \setminus W^*$ consists of all points $x \in W$ such that the whole positive semitrajectory $\phi(x, [0, \omega_x))$ is contained in W , which justifies its name. Note that if W is given, usually it is difficult to determine the set W^* (hence also the asymptotic part), since one should follow the whole positive semitrajectory of every point $x \in W$ unless it reaches the complement of W . It is even difficult to check whether $W \setminus W^*$ is nonempty. The Ważewski method provides answers to that question in some reasonable situations. On the other hand, the set W^- can be determined easier, because in order to verify whether $x \in W^-$ one needs to know the position of $\phi_t(x)$ for $t \in (0, \varepsilon)$, where $\varepsilon > 0$ is arbitrarily small.

DEFINITION 2.4. We call W a *Ważewski set* provided

- (a) if $x \in W$, $t > 0$, and $\phi(x, [0, t]) \subset \overline{W}$ then $\phi(x, [0, t]) \subset W$,
- (b) W^- is closed relative to W^* .

That definition seems to be difficult to verify in practice, at least because it is difficult to determine the set W^* . However, in the following result we indicate that in a reasonable case we do not need any information on W^* :

PROPOSITION 2.1. *If both W and W^- are closed subsets of X then W is a Ważewski set.*

In Section 1.2, we defined the notions of egress and strict egress points for an open set in the phase-space (Definition 1.2) and with their help we stated the Ważewski theorem. Using the notion of a Ważewski set we can formulate more general results. In fact, it is easy to observe that if V is an open set and every egress point is a strict egress point then $W := V \cup E$ is a Ważewski set, $W^- = E$, and $W^* = V^* \cup E$. In the following example we show that the above implication cannot be reversed.

EXAMPLE 2.1. Consider the flow generated by the equation $\dot{x} = 1$ on \mathbb{R} . Put

$$V := (-\infty, 0) \cup \bigcup_{n=1}^{\infty} \left(\frac{1}{2^n - 2^{n+2}}, \frac{1}{2^n} \right).$$

Here the set E consists of 0 and the points $1/2^n$ for $n \geq 1$. It follows that 0 is not a strict egress point although $E = W^-$ and $V \cup E$ is a Ważewski set.

In [11], there is an example illustrating a similar conclusion in which V is homeomorphic to a ball in \mathbb{R}^3 .

2.2. Properties of Ważewski sets

Let W be an arbitrary subset of X .

DEFINITION 2.5. The function $\sigma : W^* \rightarrow [0, \infty)$,

$$\sigma(x) := \sup\{t \in [0, \infty) : \phi(x, [0, t]) \subset W\}$$

is called the *escape-time function* of W .

It follows by (2.1) and (2.2) that

$$\sigma(\phi_t(x)) = \sigma(x) - t, \quad \text{if } 0 \leq t \leq \sigma(x). \tag{2.3}$$

The most important properties of Ważewski sets (including the Ważewski lemma from Section 1.2) are summarized in the following

LEMMA 2.1. *If W is a Ważewski set and σ is its escape-time function then*

- (i) *if $x \in W^*$ then $\phi_{\sigma(x)}(x) \in W^-$,*
- (ii) *$x \in W^-$ if and only if $x \in W^*$ and $\sigma(x) = 0$,*
- (iii) *σ is continuous,*
- (iv) *W^* is open relative to W .*

PROOF. Ad (i). It is clear that if $x \in W^*$ then $\phi(x, [0, \sigma(x)]) \subset \overline{W}$, hence $\phi_{\sigma(x)}(x) \in W$ by (a). Moreover $\phi(x, [0, \sigma(x) + t]) \not\subset W$ for every $t > 0$, hence, by (2.2), $\phi_{\sigma(x)}(x) \in W^-$. Thus (i) is proved.

Ad (ii). If $x \in W^-$ then, clearly, $\sigma(x) = 0$. On the other hand, if $\sigma(x) = 0$, then $x \in W^-$ by (2.1) and (i), hence (ii) follows.

Ad (iii). For the proof of (iii) assume that $x \in W^*$ and $\varepsilon > 0$. At first we prove that there exists a neighborhood U of x such that $\sigma(y) < \sigma(x) + \varepsilon$ for every $y \in U \cap W^*$. Indeed, $\phi(x, [0, \sigma(x) + \varepsilon]) \not\subset W$, hence, by (a), there exists a $t \in [\sigma(x), \sigma(x) + \varepsilon]$ such that $\phi_t(x) \notin \overline{W}$. By continuity of ϕ , there exists a neighborhood U of x such that $\phi_t(U) \subset X \setminus \overline{W}$. It is clear, that $\sigma(y) < t$ for every $y \in U \cap W^*$, hence the assertion follows.

Now we prove that there exists a neighborhood V of x such that $\sigma(x) - \varepsilon < \sigma(y)$ if $y \in V \cap W^*$. There is nothing to prove in the case $\sigma(x) = 0$, hence we can assume without loss of generality that $0 < \varepsilon < \sigma(x)$. Let $t \in [\sigma(x) - \varepsilon, \sigma(x))$. Then $\phi(x, [0, t]) \subset W^* \setminus W^-$. By (b), there is an open set Z such that $Z \cap W^* = W^* \setminus W^-$. By a standard argument, the continuity of ϕ and the compactness of $[0, t]$ imply the existence of a neighborhood V of x such that $\phi(V, [0, t]) \subset Z$. Let $y \in V \cap W^*$. By (i), $\phi_{\sigma(y)}(y) \in W^-$. Since W^- is disjoint from Z , $\sigma(y) > t$ and the proof of (iii) is finished.

Ad (iv). Finally, in order to prove (iv) assume that $x \in W^*$. By (i) and (a) there exists a $t > \sigma(x)$ such that $\phi_t(x) \notin \overline{W}$. Thus, if y belongs to some neighborhood of x then $\phi_t(y) \notin W$ and the proof of the lemma is finished. \square

We consider also the *extended escape-time function* given by

$$\sigma^+ : W \ni x \rightarrow \sup\{t \geq 0: \phi(x, [0, t]) \subset W\} \in [0, \infty].$$

Actually, that function is not continuous even if W is a compact Ważewski set as an obvious example, in which a stationary point belongs to the closure of W^- , shows. However, the following statement can be easily proved:

LEMMA 2.2. *If both W and W^- are compact then σ^+ is continuous.*

PROOF. Since W is compact, $\sigma^+(x) = \infty$ if and only if $x \in W \setminus W^*$, hence, by Lemma 2.1(iii), it suffices to prove that σ^+ is continuous at each x_0 such that $\sigma^+(x_0) = \infty$. The required continuity follows from the fact that $\text{Inv}^+(B)$ is compact (see Lemma 2.1(iv) and disjoint from W^- . Indeed, if $r > 0$ then there exists an open neighborhood U of x_0 in W such that $\phi(y, [0, r]) \cap W^- = \emptyset$, hence $\sigma^+(y) \geq r$ for every $y \in U$. \square

2.3. Versions of the Ważewski theorem

The Ważewski theorem appears in the literature in various forms and each of them is a direct application of Lemma 2.1 stated above, especially its part (iii) (i.e., the Ważewski lemma). Our purpose is to formulate the theorem in a form convenient for applications. In fact, we present two theorems. The first one is a direct generalization of the main theorems of [85] and [20] obtained in a possibly most “economic” way. It is sufficient for a great majority of applications existing in the literature. However, as we show in a relatively simple example, it is sometimes convenient to have its stronger version and such a version will be presented at the end of the current section. In any case we should extend the notion of a strong deformation retract given in Definition 1.1. To this purpose we follow the ideas from the papers [58,62].

Assume that X is a topological space and A and B are subsets of X such that $A \subset B$.

DEFINITION 2.6. A is called a *strong deformation retract of B in X* if there exists a continuous map $h : B \times [0, 1] \rightarrow X$ (for which we also write $h_t(x)$ instead of $h(x, t)$) such that

- (a) $h(x, 0) = x$ for every $x \in B$,
- (b) $h(x, t) = x$ for every $x \in A$ and $t \in [0, 1]$,
- (c) $h_1(B) \subset A$.

Obviously, in the case $B = X$, A is a strong deformation retract of B in the usual sense (see Definition 1.1). Moreover, if A is a strong deformation retract of B in X then A is a retract of B , if $X' \supset X$ then A is also a strong deformation retract of B in X' , and if A is a strong deformation retract of X then A is also a strong deformation retract of B in X for every B such that $A \subset B \subset X$. A comparison among various types of retracts can be visualized on Figure 4. Here X is the grey rectangle with a hole, A is its bottom edge, and L and R are the circles—only R surrounds the hole. It is readily seen that A is a strong

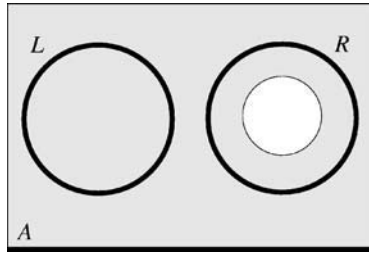

Fig. 4.

deformation retract of $A \cup L$ in X , A is a retract of $A \cup R$, and A is not a strong deformation retract of $A \cup R$ in X .

In the following sequence of results we assume that

- W is a Ważewski set,
- σ is the escape-time function of W ,
- Z is a subset of W ,
- Y is a subset of W^- such that $Z \cap W^- \subset Y$.

THEOREM 2.1 (Ważewski theorem—an improved statement). *If Y is not a strong deformation retract of $Z \cup Y$ in $(W \setminus W^-) \cup Y$ then there exists an $x_0 \in Z$ such that*

- either $\phi^+(x_0) \subset W \setminus W^-$,
- or else $x_0 \in W^*$ and $\phi_{\sigma(x_0)}(x_0) \in W^- \setminus Y$.

PROOF. Assume that the conclusion is false. It follows that $Z \subset W^*$ and for every $x \in Z$ its consequent $\phi_{\sigma(x)}(x)$ is contained in Y . For every $x \in Z \cup Y$ and every $s \in [0, \sigma(x)]$ the point $\phi_s(x) \notin W^- \setminus Y$, hence, by Lemma 2.1, the map

$$(Z \cup Y) \times [0, 1] \ni (x, t) \rightarrow \phi_{t\sigma(x)}(x) \in (W \setminus W^-) \cup Y$$

is continuous and satisfies (a)–(c) in Definition 2.6 contradictory to the assumption, hence the result follows. □

As an immediate consequence we get

COROLLARY 2.1. *If Y is not a retract of $Z \cup Y$ then the conclusion of Theorem 2.1 holds.*

Theorem 2.1 does not follow from Corollary 2.1 as an example based on Figure 4 shows. The original Ważewski theorem stated in Section 1.2 is a corollary of the above one. We repeat it below in a more general setting (as we already mentioned in Section 2.1, Ważewski sets naturally generalize the sets considered in [85]).

COROLLARY 2.2. *If $Z \cap Y$ is a retract of Y and $Z \cap Y$ is not a retract of Z then the conclusion of Theorem 2.1 holds.*

PROOF. It suffices to prove that under the imposed hypotheses there is no retraction $Z \cup Y \rightarrow Y$. Indeed, if there exists a retraction of $Z \cup Y$ onto Y , its composition with a retraction $Y \rightarrow Z \cap Y$ provides a retraction $Z \rightarrow Z \cap Y$ contrary to the assumption. \square

In the case $Y = W^-$, there is an essential simplification in the statement of Theorem 2.1:

COROLLARY 2.3. *If W^- is not a strong deformation retract of $Z \cup W^-$ in W then there exists an $x_0 \in Z$ such that $\phi^+(x_0) \subset W$.*

In particular, the version of the Ważewski theorem given in [20] is the following

COROLLARY 2.4 (Ważewski theorem—the Conley’s version). *If W^- is not a strong deformation retract of W then there exists an $x_0 \in W$ such that $\phi^+(x_0) \subset W$.*

In the case of compact W one can get the full solution contained in W .

COROLLARY 2.5. *Let W be a compact set. If W^- is not a strong deformation retract of W then there exists an $x_0 \in W$ such that $\emptyset \neq \omega(x_0) \subset W$. In particular, W contains a nonempty invariant set.*

PROOF. By Corollary 2.4, there exists an x such that $\phi^+(x) \subset W$. Since W is compact, the ω -limit set of x is nonempty. Since the latter set is invariant, the result follows. \square

Throughout remainder of this section we will consider local flows. The last version of the Ważewski theorem presented in this section is due to Andrzej Pliś in [62]. In order to state it, we again modify the notion of a strong deformation retract. Let X be a topological space and let A be a subset of $B \subset X$.

DEFINITION 2.7. A is called a *quasi-isotopic deformation retract of B in X* if there exists a continuous map $h : B \times [0, 1] \rightarrow X$ such that the conditions (a), (b), and (c) in Definition 2.6 are satisfied, and

(d) $B \ni x \rightarrow h_t(x) \in h_t(B)$ is a homeomorphism if $0 \leq t < 1$.

In the case $B = X$ we simply call A a *quasi-isotopic deformation retract of X* . Obviously, a quasi-isotopic deformation retract of B in X is a strong deformation retract of B in X . The following version of the Ważewski theorem essentially appeared in [62].

THEOREM 2.2 (Ważewski theorem—the version of Pliś). *Let ϕ be a local flow. If Y is not a quasi-isotopic deformation retract of $Z \cup Y$ in $(W \setminus W^-) \cup Y$ then the conclusion of Theorem 2.1 holds.*

PROOF. We assume that the conclusion is false. It follows that $Z \subset W^*$ and $\phi_{\sigma(x)}(x) \in Y$ for $x \in Z$. As in the proof of Theorem 2.1, for $x \in Z \cup Y$ and $t \in [0, 1]$ we put

$$h(x, t) := \phi(x, t\sigma(x))$$

and using Lemma 2.1 we conclude that $h(x, t) \in (W \setminus W^-) \cup Y$ and h is continuous and satisfies (a)–(c) in Definition 2.6. Thus, in order get a contradiction by proving that Y is a quasi-isotopic deformation retract of $Z \cup Y$ in $(W \setminus W^-) \cup Y$ it remains to prove that if $t < 1$ then h_t is a homeomorphism as a map $Z \cup Y \rightarrow h_t(Z \cup Y)$. Fix $t < 1$ and for $y \in h_t(Z \cup Y)$ put

$$g(y) := \phi(y, -(1-t)^{-1}t\sigma(y)).$$

Let $y = h_t(x)$ and $x \in Z \cup Y$. Since $\sigma(y) = (1-t)\sigma(x)$ by (2.3) and $y = \phi(x, t\sigma(x))$,

$$g(y) = \phi(y, -t\sigma(x)) = x.$$

It follows that $g : h_t(Z \cup Y) \rightarrow Z \cup Y$ and $g \circ h_t$ is equal to the identity. On the other hand,

$$(h_t \circ g)(h_t(x)) = h_t(x),$$

hence $h_t \circ g$ is equal to the identity on $h_t(Z \cup Y)$. Thus h_t is a homeomorphism (and g is its inverse), which concludes the proof. \square

Obviously, Theorem 2.2 implies Theorem 2.1 as a corollary in the case ϕ is a local flow. Using an example based on Figure 5, below we indicate that it is a stronger result.

EXAMPLE 2.2. Let the phase-space of a local flow be equal to \mathbb{R}^3 and let W be equal to a cube as shown on Figure 5. Assume that the shaded rear and front sides of the cube form the exit set W^- . Let the set Z consists of two linked disjoint arcs, each of them is attached by its ends to one of the components of W^- . We claim that there exists a positive semitrajectory starting in Z and contained in W .

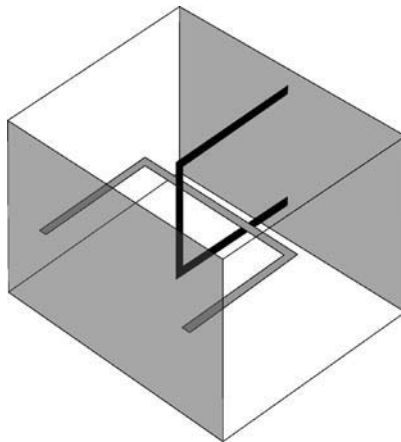

Fig. 5.

Corollary 2.3 is useless in attempts to prove the claim because W^- is a strong deformation retract of $Z \cup W^-$ in W . Indeed, it suffices to push each of the components of Z to the corresponding side of the cube. Nevertheless, we assert that W^- is not a quasi-isotopic deformation retract of $Z \cup W^-$ in W , hence, by Theorem 2.2, there is a required positive semitrajectory.

In order to verify the assertion, assume on the contrary that W^- is a quasi-isotopic deformation retract of $Z \cup W^-$ in W and denote by h an associated homotopy which satisfies the conditions (a)–(d). Let Γ_1 and Γ_2 be two sets homeomorphic to the circle S^1 , each of them is contained in a different components of $Z \cup W^-$ and surrounds the corresponding hole. Thus the *linking number* (compare [17, II.15] in the smooth case or [28, VII.4.17] in the purely topological setting) of Γ_1 and Γ_2 is equal to ± 1 . On the other hand, since both the sets are compact, h is continuous, and (c) is valid, there exists an $\varepsilon > 0$ such that if $1 - \varepsilon < t < 1$ then each of the sets $h_t(\Gamma_i)$ is so close to the side to which it is attached that there is no link between $h_t(\Gamma_1)$ and $h_t(\Gamma_2)$. Thus their linking number is equal to 0. This is a contradiction, since $h_s(\Gamma_1) \cap h_s(\Gamma_2) = \emptyset$ for every $s \in [0, t]$ by (d), which implies that the linking number is preserved under the continuation over the interval $[0, t]$.

REMARK 2.1. In Example 2.2, we concluded by Theorem 2.2 that for every local flow there is a positive semitrajectory starting at Z and contained in W . Actually, in this example the same conclusion holds for local semiflows. Indeed, this is a consequence of the homotopy property of the linking number and the modified Theorem 2.2 valid for local semiflows, for which the notion of quasi-isotopic deformation retract is changed by substituting the condition

(e) if $x, y \in B$, $t < 1$, and $h_t(x) = h_t(y)$ then $h_s(x) = h_s(y)$ for every $s \in (t, 1]$, instead of (d) in Definition 2.7.

3. Ważewski method in ordinary differential equations and inclusions

Abstract local flows and semiflows, for which we describe the Ważewski method in Section 2, arise in the theory of differential equations. Here we present how to construct Ważewski sets in ordinary differential equations and give some extensions of the method to equations which do not generate local semiflows.

3.1. Polyfacial sets

A usual construction of Ważewski sets is based on existence of functions which behave similarly to Liapunov functions on some parts of their zero-levels. In the sequel by M we denote a smooth (i.e., of C^∞ class) Riemannian manifold without boundary, by TM its tangent bundle, by the dot \cdot the induced scalar product in each tangent space $T_x M$, and by $\nabla f(x)$ the corresponding gradient of a function $f : M \rightarrow \mathbb{R}$ differentiable at x . Let v be a vector-field on M , i.e., a continuous map $v : M \rightarrow TM$ such that $v(x) \in T_x M$ for every $x \in M$. Let p and q be nonnegative integers, $p + q \geq 1$, and for $i = 1, \dots, p$

and $j = 1, \dots, q$ let ℓ^i and m^j be continuous functions $M \rightarrow \mathbb{R}$ of C^1 -class in some neighborhoods of their zero levels. Put

$$V := \{x \in M: \ell^i(x) < 0 \forall i = 1, \dots, p, m^j(x) < 0 \forall j = 1, \dots, q\}$$

and for the above i and j define

$$L^i := \{x \in \partial V: \ell^i(x) = 0\}, \tag{3.1}$$

$$M^j := \{x \in \partial V: m^j(x) = 0\}. \tag{3.2}$$

(We do not exclude the possibility $p = 0$ or $q = 0$; in such a case one of the corresponding families of functions and sets is empty.)

DEFINITION 3.1. The set V is called a *polyfacial set determined by the set of functions* $\{\ell^i, m^j\}$. If, moreover,

$$v(x) \cdot \nabla \ell^i(x) > 0, \quad \text{if } x \in L^i, \tag{3.3}$$

$$v(x) \cdot \nabla m^j(x) < 0, \quad \text{if } x \in M^j \tag{3.4}$$

for every $i = 1, \dots, p$ and every $j = 1, \dots, q$ then it is called a *polyfacial set for the vector-field* v (or, alternatively, for the differential equation (1.1)).

The concept of a polyfacial set comes from the original paper [85]. In that paper the subsets L^i were called its *positive faces*, while M^j were its *negative faces*, which terminology is justified by (3.3) and (3.4). (Here we try to avoid that terminology because, as we will see soon, L^i is contained in the exit set $\overline{V^-}$.)

Throughout reminder of this section we assume that V is the polyfacial set for v determined by $\{\ell^i, m^j\}$. Assume that Equation (1.1) generates a local flow ϕ . It follows by (3.3) that if $x \in L^i$ then there exists an $\varepsilon > 0$ such that $\ell^i(\phi_t(x)) > 0$ (hence $\phi_t(x) \notin \overline{V}$) for each $t \in (0, \varepsilon)$ and $\ell^i(\phi_t(x)) < 0$ for each $t \in (-\varepsilon, 0)$. If $x \in M^j$ then (3.4) implies the reversed inequalities for $m^j(\phi_t(x))$. Recall, that in Definition 1.2 we provided the notions of strict egress, strict ingress, and outer tangency points on the boundary of a given open set.

PROPOSITION 3.1. *If $x \in \partial V$ then*

- (i) *x is a strict egress point if and only if $x \in L^i$ for some $i = 1, \dots, p$ and $x \notin M^j$ for every $j = 1, \dots, q$,*
- (ii) *x is a strict ingress point if and only if $x \in M^j$ for some $j = 1, \dots, q$ and $x \notin L^i$ for every $i = 1, \dots, p$,*
- (iii) *x is an outward tangency point if and only if $x \in L^i \cap M^j$ for some $i = 1, \dots, p$ and $j = 1, \dots, q$,*
- (iv) *x is a strict egress or strict ingress, or outward tangency point (hence no other possibility holds).*

PROOF. Let $x \in \partial V$.

Ad (i). Assume that x is a strict egress point. Then $x \notin M^j$ for every j . Since

$$\partial V \subset \bigcup_{i=1}^p L^i \cup \bigcup_{j=1}^q M^j, \tag{3.5}$$

the implication from the left to the right follow. On the other hand, assume that $x \in L^{i_0}$ for some i_0 and $x \notin M^j$ for every j . One has $\ell^i(x) \leq 0$ for every i and $m^j(x) \leq 0$ for every j since $x \in \overline{V}$. It follows by the assumption that $m^j(x) < 0$ for every j , hence also $m^j(\phi_t(x)) < 0$ for $t < 0$ such that $|t|$ is small. If $\ell^i(x) < 0$ then, as before, $\ell^i(\phi_t(x)) < 0$ for $t < 0$ with $|t|$ small. The other possibility $\ell^i(x) = 0$ implies that $\phi(x, (0, \varepsilon_i)) \subset \setminus \overline{V}$ and $\ell^i(\phi_t(x)) < 0$ if $-\varepsilon_i < t < 0$ for some $\varepsilon_i > 0$. Thus, there exists an $\varepsilon > 0$ such that $\phi_t(x) \in V$ if $-\varepsilon < t < 0$. Moreover, $\phi(x, (0, \varepsilon_{i_0})) \subset \setminus \overline{V}$, hence the result follows.

Ad (ii). After reversing the time-direction it follows from (i).

Ad (iii). Assume that x is an outward tangency point. It follows by (3.5) and (i) and (ii) that $x \in L^i$ for some i and $x \in M^j$ for some j . The other implication is obvious.

Ad (iv). It follows by (3.5) and (i), (ii), and (iii). □

Denote by E the set of strict egress points and by T the set of outward tangency points. As an immediate consequence of Proposition 3.1 we get the following equations

$$E = \bigcup_{i=1}^p L^i \setminus \bigcup_{j=1}^q M^j, \tag{3.6}$$

$$E \cup T = \bigcup_{i=1}^p L^i. \tag{3.7}$$

Proposition 3.1 indicates also which subsets of \overline{V} are Ważewski sets. Usually there are infinitely many of them. In the following straightforward result two of them are distinguished:

PROPOSITION 3.2.

- (i) *The set $V \cup E$ is a Ważewski set and its exit set is equal to E .*
- (ii) *The set \overline{V} is a Ważewski set and its exit set is equal to $E \cup T$.*

The sets considered in [85] assumed the form (i). Ważewski sets obtained from polyfacial sets have an advantage in comparison to some other constructions: they are stable with respect to small perturbations of the vector-field (since the inequalities (3.3) and (3.4) are strict). In the following definition we distinguish a special class of polyfacial sets.

DEFINITION 3.2. Let V be a polyfacial set determined by $\{\ell^i, m^j\}$. It is called *regular* if for every $x \in \partial V$ the set $\{\nabla \ell^{i_1}(x), \dots, \nabla \ell^{i_r}(x), \nabla m^{j_1}(x), \dots, \nabla m^{j_s}(x)\}$ is linearly independen-

dent provided $1 \leq i_1 < \dots < i_r \leq p$ and $1 \leq j_1 < \dots < j_s \leq q$, and

$$\begin{aligned} \{i_1, \dots, i_r\} &= \{i = 1, \dots, p: \ell^i(x) = 0\}, \\ \{j_1, \dots, j_s\} &= \{j = 1, \dots, q: m^j(x) = 0\}. \end{aligned}$$

REMARK 3.1. If V is a regular polyfacial set then \overline{V} is a topological submanifold with boundary in M and the exit set $\overline{V}^- = E \cup T$ is a topological submanifold of ∂V . In particular, all homology and cohomology functors for the pair $(\overline{V}, \overline{V}^-)$ coincide. One can prove that for every such functor H ,

$$H(\overline{V}, \overline{V}^-) = H(V \cup E, E).$$

If, moreover, $p = q = 1$, i.e., $V = \{\ell < 0, m < 0\}$ then the set \overline{V} is a C^1 -class submanifold with corners and the exit set is a C^1 -class submanifold with boundary.

In practice, the Ważewski method is most frequently applied to non-autonomous equations. Let U be an open subset of $\mathbb{R} \times M$ and let $w : U \rightarrow TM$ be time-dependent vector-field, i.e., a continuous map such that $w(t, x) \in T_x M$ for every $(t, x) \in U$. Assume that it generates the equation

$$\dot{x} = w(t, x) \tag{3.8}$$

for which the Cauchy problem $x(t_0) = x_0$ has the unique solution. We consider the induced system

$$\begin{aligned} \dot{t} &= 1, \\ \dot{x} &= w(t, x) \end{aligned} \tag{3.9}$$

in the extended phase space U and the vector-field $v := (1, w)$ on its right-hand side. All the previous results can be applied to v since U is also a manifold without boundary. In the case $M = \mathbb{R}^n$ the inequalities (3.3) and (3.4) assume the forms

$$\frac{\partial \ell^i}{\partial t}(t, x) + \sum_{k=1}^n \frac{\partial \ell^i}{\partial x_k}(t, x) w_k(t, x) > 0, \quad \text{if } (t, x) \in L^i, \tag{3.10}$$

$$\frac{\partial m^j}{\partial t}(t, x) + \sum_{k=1}^n \frac{\partial m^j}{\partial x_k}(t, x) w_k(t, x) < 0, \quad \text{if } (t, x) \in M^j. \tag{3.11}$$

In particular, the set $\{(t, x, y) \in \mathbb{R}^3: |x| < 1, |y| < 1\}$ considered in Example 1.1 and shown on Figure 2 is a polyfacial set determined by the functions

$$\ell : (t, x, y) \mapsto x^2 - 1, \quad m : (t, x, y) \mapsto y^2 - 1$$

and the set $\{(t, x, y) \in \mathbb{R}^3: t < 1, |x| < 1, |y| < 1\}$ in Example 1.2 (see Figure 3) is a polyfacial set determined by the functions

$$\ell^1: (t, x, y) \mapsto x^2 - 1, \quad \ell^2: (t, x, y) \mapsto t - 1, \quad m: (t, x, y) \mapsto y^2 - 1.$$

3.2. Equations without the uniqueness property and differential inclusions

Using polyfacial sets, in this section we extend the Ważewski method to the case in which the vector-field $v: M \rightarrow TM$ does not satisfy the uniqueness property of the initial value problem (1.1), (1.2). Since it does not involve any essential difficulty, we will extend the Ważewski method even further: we will consider differential inclusions. The idea of an extension to equations without uniqueness comes from the original paper [85] of Ważewski, while the extension to differential inclusions was initiated by Bielecki in [12] (he used the term *paratingent equations*). Our presentation is based on the Bielecki’s approach.

As in Section 3.1, we assume that M is Riemannian manifold with a given metric. Let F be a multivalued vector-field on M , i.e., for every $x \in M$ we assign a nonempty compact and convex set $F(x) \subset T_xM$. In what follows we assume that F is *upper semi-continuous*, i.e., for every $x \in M$ and every ε there exists a neighborhood U of x such that if $y \in U$ then $F(y)$ is contained in the ε -neighborhood $N(F(x), \varepsilon)$ of $F(x)$ in TM . (In particular, every single-valued continuous vector-field has that property.) By a solution of a *differential inclusion*

$$\dot{x} \in F(x) \tag{3.12}$$

we mean an absolutely continuous mapping $t \mapsto x(t)$ defined in some interval such that $\dot{x}(t) \in F(x(t))$ for almost every t . We assume also that the domain of x is maximal, i.e., the solution is saturated.

Below we assume that V be a polyfacial set determined by $\{\ell^i, m^j\}, i = 1, \dots, p, j = 1, \dots, q, p + q \geq 1$, and the sets L^i, M^j , and let E are given by, respectively, (3.1), (3.2), and (3.6).

DEFINITION 3.3. V is called a *polyfacial set for (3.12)* if for every i and j ,

$$\begin{aligned} y \cdot \nabla \ell^i(x) &> 0, \quad \text{for all } y \in F(x) \text{ and } x \in L^i, \\ y \cdot \nabla m^j(x) &< 0, \quad \text{for all } y \in F(x) \text{ and } x \in M^j. \end{aligned}$$

In the sequel we assume that V is a polyfacial set for (3.12). Our aim is to prove the following extension of the Ważewski theorem, which essentially were given in [12]:

THEOREM 3.1. *Let $Y \subset E$ and $Z \subset V \cup Y$. Assume that Z and $E \setminus Y$ are compact and Y is not a quasi-isotopic deformation retract of $Z \cup Y$ in $V \cup E$. Then there exists a solution x of (3.12) such that $x(0) \in Z$ and*

- either $x(t) \in \bar{V}$ for all $t \geq 0$
- or there exists a $t_0 > 0$ such that $x(t) \in \bar{V}$ if $t \in [0, t_0]$ and $x(t_0) \in E \setminus Y$.

PROOF. We will base on the results stated in [4], although they concern the case $M = \mathbb{R}^n$ only. In the case of an arbitrary manifold M they can be stated in a similar way. Let v_n be a sequence of locally Lipschitz vector-fields such that their graphs in TM approximate the graph of F and preserve the strong inequalities (3.3) and (3.4) (compare [4, Theorem 1.12.1]). By Theorem 2.2, for each n either there exists a point $x_n \in Z$ such that the solution of the equation

$$\dot{x} = v_n(x)$$

starting at x_n remains in V or there exists an y_n and $t_n > 0$ such that the solution starting at y_n remains in V for $t \in [0, t_n]$ and $y_n(t_n) \in E \setminus Y$. At least one of the sequences $\{x_n\}$ and $\{y_n\}$ must be infinite. An accumulation point of that infinite sequence has the required properties (compare First Proof of Theorem 2.1.3 in [4]; observe moreover that the time t_0 in the conclusion is positive since the distance between Z and $E \setminus Y$ is nonzero). \square

We get the following corollary as an immediate consequence of the theorem in the case $Y = E$:

COROLLARY 3.1. *If $H(V \cup E, E) \neq 0$, where H is the singular homology functor with coefficients in a given ring, then there exists a solution x of (3.12) such that $x(t) \in \bar{V}$ for all $t \geq 0$.*

PROOF. Indeed, by the assumption there exists a singular chain c in $V \cup E$ which is a homologically nontrivial cycle with respect to the pair $(V \cup E, E)$, hence its support $Z := |c|$ cannot be continuously deformed to E . Thus Z is compact and satisfies the assumption of Theorem 3.1, hence the result follows. \square

The questions concerning the existence of solutions contained in a given set are important in the theory of differential inclusions; the area of research related to them bears the name *viability theory* (compare [3,4]). In that theory, a set W is called *viable at x_0* if $x_0 \in W$ and there exists a solution x with $x(0) = x_0$ and $x(t) \in W$ for all $t \geq 0$.

Apart from the Bielecki’s paper, Ważewski-type theorems for equations without uniqueness and differential inclusions appeared in several publications, compare for example [6–9,40,43]. Opposite to the approximation argument in the above proof, a purely topological approach based on set-valued retractions was frequently presented and the obtained results were limited in practice to questions of lack of connectedness. Recently, in the paper [35], Gabor and Quincampoix applied homology theory methods for *admissible* multivalued mappings (see [33]) to obtain stronger results in that topological setting. In particular, [35] contains a theorem similar to Corollary 3.1 valid for closed sets which resemble the Ważewski ones. We state it below.

Assume that $M = \mathbb{R}^n$. F is called a *Marchaud map* if there exists a $C > 0$ such that

$$\sup\{|y|: y \in F(y)\} \leq C(1 + |x|)$$

for every $x \in \mathbb{R}^n$. For $x_0 \in \mathbb{R}^n$ denote by $S_F(x_0)$ the set of solutions of the initial value problem (3.12), (1.2). We extend the notion of exit set and escape-time function to the case of differential inclusions; for $W \subset \mathbb{R}^n$ put

$$W^- := \{x_0 \in \partial W: \exists x \in S_F(x_0) \forall t > 0: x([0, t]) \not\subset W\}$$

and for each solution x of (3.12) satisfying $x(0) \in W$ define

$$\Sigma(x) := \sup\{t \geq 0: x([0, t]) \in W\}.$$

THEOREM 3.2 (compare Theorem A and Remark 2.1 in [35]). *Let F be a Marchaud map and let W and W^- be closed subsets of \mathbb{R}^n . Assume that for every $x_0 \in W^-$ and every $x \in S_F(x_0)$,*

$$x([0, \Sigma(x)]) \subset W^-$$

provided $\Sigma(x) < \infty$. If $\check{H}(W, W^-) \neq 0$ then there exists a solution x of (3.12) such that $x(t) \in W$ for all $t \geq 0$, where \check{H} denotes the Čech homology functor with compact supports and coefficients in \mathbb{Q} .

In the case of Marchaud maps, Theorem 3.2 generalizes Corollary 3.1 if the considered polyfacial set V is regular (see Definition 3.2) and the ring of coefficients of H is equal to \mathbb{Q} . Indeed, in that case the Čech and singular homologies coincide by Remark 3.1, but Theorem 3.2 allows empty interior of W and sliding along W^- . In the next section we indicate that for regular polyfacial sets there is a stronger version of Corollary 3.1 which also allows sliding along the boundary.

3.3. Weak inequalities in polyfacial sets

The proof of Theorem 3.1 was essentially based on the strong inequalities (3.13) and (3.13). One can ask whether the replacement of those strong inequalities by the weak ones still provides results similar to that theorem. That question was considered in the paper [37]; in particular, for regular polyfacial sets. The following version of the Ważewski theorem is based on [37, Theorem 3].

THEOREM 3.3. *Let V be a regular polyfacial set determined by $\{\ell^i, m^j\}$, and let L^j, M^i , and E be given by, respectively, (3.1), (3.2), and (3.6). Let Y and Z satisfy the assumptions of Theorem 3.1. Assume moreover that F is a multivalued vector-field such that the weak inequalities*

$$\begin{aligned} y \cdot \nabla \ell^i(x) &\geq 0, & \text{for all } y \in F(x) \text{ and } x \in L^i, \\ y \cdot \nabla m^j(x) &\leq 0, & \text{for all } y \in F(x) \text{ and } x \in M^j. \end{aligned}$$

are satisfied for every i and j . Then the conclusion of Theorem 3.1 holds.

PROOF. The idea of a proof is to add to the right-hand side of (3.12) a sequence of perturbation terms of the form $\phi_n h$, where h is a bounded vector-field satisfying

$$\begin{aligned} h(x) \cdot \nabla \ell^i(x) &> 0, & \text{if } x \in L^i, \\ h(x) \cdot \nabla m^j(x) &< 0, & \text{if } x \in M^j, \end{aligned}$$

for every i and j , and ϕ_n is a sequence of continuous, positive-valued functions such that ϕ_n tends to zero uniformly on compact sets. It follows that one can apply Theorem 3.1 to the inclusions

$$\dot{x} \in F(x) + \phi_n(x)h(x).$$

As in the proof of Theorem 3.1, the required point x_0 is obtained as an accumulation point of the obtained sequence of points. The vector-field h can be constructed as follows: for every x_0 in the boundary of V find a vector w such that

$$w \cdot \nabla \ell^i(x_0) > 0, \quad w \cdot \nabla m^j(x_0) < 0$$

if $\ell^i(x_0) = 0$ and $m^j(x_0) = 0$. Such a vector exists thanks to the linear independence of the gradients (in order to verify that assertion one can adapt the argument in the proof of Farkas Lemma in linear programming). The vector w can be extended to a vector-field in a neighborhood of x_0 such that the strong inequalities are preserved. Those vector-fields defined locally can be glued using a partition of unity to the global vector-field satisfying the required properties. Details of the construction in the case $M = \mathbb{R}^n$ can be found in [37]. □

3.4. Generalized polyfacial sets

Let us return to the case in which $v : M \rightarrow TM$ is a vector-field on the Riemannian manifold M . If v generates a local flow ϕ , one can still obtain a Ważewski set on the similar way to the one described in Section 3.1 if a more general type of inequalities than (3.3) and (3.4) occurs. Let $n : M \rightarrow \mathbb{R}$ be a C^1 -function, let N be equal to the set $\{x \in M : n^k(x) \leq 0\}$, and let $x_0 \in N$ be such that

$$v(x_0) \cdot \nabla n(x_0) = 0. \tag{3.13}$$

In order to get the outward tangency property of the trajectory of x_0 with respect to N , the value of the function $t \mapsto n(\phi_t(x_0))$ should assume a sharp local minimum at $t = 0$. This is guaranteed if its second derivative at $t = 0$ exists and is positive (or, more generally, the lowest-order nonzero derivative is even and positive). By a simple calculation we conclude that the second-order criterium is satisfied if the function

$$v \cdot \nabla n : M \ni x \rightarrow \nabla n(x) \cdot v(x) \in \mathbb{R}$$

is differentiable at x_0 and the condition

$$v(x_0) \cdot \nabla(v \cdot \nabla n)(x_0) > 0 \tag{3.14}$$

holds. That observation leads to the following generalization of the notion of polyfacial set (compare [24,25]). Let $p + q + r \geq 1$ and let ℓ^i for $i = 1, \dots, p$, m^j for $j = 1, \dots, q$, and n^k for $k = 1, \dots, r$ be continuous functions $M \rightarrow \mathbb{R}$ of C^1 -class in some neighborhoods of their zero levels. Similarly as in Section 3.1, put

$$V := \{x \in M: \ell^i(x) < 0 \ \forall i, \ m^j(x) < 0 \ \forall j, \ n^k(x) < 0 \ \forall k\},$$

$$L^i := \{x \in \partial V: \ell^i(x) = 0\},$$

$$M^j := \{x \in \partial V: m^j(x) = 0\},$$

$$N^k := \{x \in \partial V: n^k(x) = 0\}.$$

DEFINITION 3.4. The set V is called a *generalized polyfacial set determined by* $\{\ell^i, m^j, n^k\}$. It is called a *generalized polyfacial set for* v (or, alternatively, for (1.1)) provided the inequalities (3.3) and (3.4) hold for every $i = 1, \dots, p$ and $j = 1, \dots, q$, and, moreover, for every $k = 1, \dots, r$ the function $v \cdot \nabla n^k$ is of C^1 -class in a neighborhood of its zero level, and for every $x \in N^k$ one of the following conditions is satisfied:

$$v(x) \cdot \nabla n^k(x) > 0, \tag{3.15}$$

$$v(x) \cdot \nabla n^k(x) < 0, \tag{3.16}$$

$$v(x) \cdot \nabla n^k(x) = 0, \quad \overline{v(x) \cdot \nabla(v \cdot \nabla n^k)}(x) > 0. \tag{3.17}$$

In the case $M = \mathbb{R}^n$, the expressions which appear on the left sides of the inequalities assume the forms

$$v(x) \cdot \nabla n^k(x) = \sum_{i=1}^n \frac{\partial n^k}{\partial x_i}(x) v_i(x), \tag{3.18}$$

$$v(x) \cdot \nabla(\nabla n^k \cdot v)(x) = \sum_{i,j=1}^n \left(\frac{\partial^2 n^k}{\partial x_i \partial x_j}(x) v_i(x) v_j(x) + \frac{\partial n^k}{\partial x_i}(x) \frac{\partial v_i}{\partial x_j}(x) v_j(x) \right) \tag{3.19}$$

whenever their right-hand sides are defined. They can be directly translated to the case of Equation (3.9) in \mathbb{R}^{n+1} in order to get analogous inequalities to (3.11) and (3.10). In particular, for a scalar second order equation

$$x'' = g(t, x, x'), \tag{3.20}$$

where $g: \mathbb{R}^3 \rightarrow \mathbb{R}$ is continuous, the corresponding equation of the form (3.9) is given by

$$\dot{i} = 1, \quad \dot{x} = y, \quad \dot{y} = g(t, x, x'), \tag{3.21}$$

i.e., $v(t, x, y) = (1, y, g(t, x, x'))$, and the counterparts of (3.18) and (3.19) are

$$\begin{aligned} &v(t, x, y) \cdot \nabla n^k(t, x, y) \\ &= \frac{\partial n^k}{\partial t}(t, x, y) + \frac{\partial n^k}{\partial x}(t, x, y)y + \frac{\partial n^k}{\partial y}(t, x, y)g(t, x, y), \end{aligned} \tag{3.22}$$

$$\begin{aligned} &v(t, x, y) \cdot \nabla(\nabla n^k \cdot v)(t, x, y) \\ &= \begin{bmatrix} 1 & y \end{bmatrix} \begin{bmatrix} \frac{\partial^2 n^k}{\partial t^2}(t, x) & \frac{\partial^2 n^k}{\partial t \partial x}(t, x) \\ \frac{\partial^2 n^k}{\partial x \partial t}(t, x) & \frac{\partial^2 n^k}{\partial x^2}(t, x) \end{bmatrix} \begin{bmatrix} 1 \\ y \end{bmatrix} + \frac{\partial n^k}{\partial x}(t, x)g(t, x, y). \end{aligned} \tag{3.23}$$

Let us return to the general case and for $k = 1, \dots, r$ define

$$\begin{aligned} N_-^k &:= \{x \in N^k : x \text{ satisfies (3.15)}\}, \\ N_+^k &:= \{x \in N^k : x \text{ satisfies (3.16)}\}, \\ N_0^k &:= \{x \in N^k : x \text{ satisfies (3.17)}\}. \end{aligned}$$

Assume again that v generates a local flow ϕ , i.e., (1.1) satisfies the uniqueness property of the corresponding Cauchy problem. Taking into account remarks on the beginning of the current section, by an argument similar to the one in the proof of Proposition 3.1 one can observe that the sets of strict egress points E and the set of outward tangency points T of V are determined by

$$E = \left(\bigcup_{i=1}^p L^i \cup \bigcup_{k=1}^r N_-^k \right) \setminus \left(\bigcup_{j=1}^q M^j \cup \bigcup_{k=1}^r (N_+^k \cup N_0^k) \right), \tag{3.24}$$

$$E \cup T = \bigcup_{i=1}^p L^i \cup \bigcup_{k=1}^r (N_-^k \cup N_0^k) \tag{3.25}$$

and the same assertion as in Proposition 3.2 holds:

PROPOSITION 3.3. *If V is a generalized polyfacial set for v then:*

- (i) *the set $V \cup E$ is a Ważewski set and its exit set is equal to E ,*
- (ii) *the set \overline{V} is a Ważewski set and its exit set is equal to $E \cup T$.*

REMARK 3.2. If V is a generalized polyfacial set is determined by only one function n , i.e., $V = \{n < 0\}$, and $\nabla n(x) \neq 0$ for every x such that $n(x) = 0$ then \overline{V} is a C^1 -class submanifold with boundary in the phase-space M and the set $\overline{V^-}$ is a C^1 -class submanifold with boundary in ∂V . Moreover, the same properties on homology or cohomology as stated in Remark 3.1 hold.

REMARK 3.3. Let V be a generalized polyfacial set for (1.1). If (1.1) satisfies the uniqueness property then Theorem 2.2 holds for the sets described in Proposition 3.3. On the other hand, if it does not satisfy the uniqueness property, a theorem similar to Theorem 3.1 can be formulated for those sets provided there is a sequence of locally Lipschitzean vector-fields v_n approximating v such that (3.15), (3.16), and (3.17) with v replaced by v_n hold on, respectively, N_-^k , N_+^k , and N_0^k . This can be justified by analyzing the argument in the proof of Theorem 3.1.

4. Ważewski method for retarded functional differential equations

Now we consider local semiflows generated by retarded functional differential equations (RFDEs). We provide results concerning the Ważewski method for those equations which go beyond direct substitutions of the abstract Ważewski-type theorems from Section 2 to those semiflows.

4.1. Local semiflows generated by RFDEs

Let M be a Riemannian manifold. For each continuous function $x : J \rightarrow M$, where $J \subset \mathbb{R}$, and for each $t \in \mathbb{R}$ put $x_t(\tau) := x(t + \tau)$ whenever it is defined. For some $r > 0$ let $\mathbf{C} := C([-r, 0], M)$ be the set of continuous mappings $u : [-r, 0] \rightarrow M$ endowed with the topology of uniform convergence. Let $F : \mathbf{C} \rightarrow TM$ be a continuous map such that $F(u) \in T_{u(0)}M$ for every $u \in \mathbf{C}$. By a solution of the retarded functional differential equation

$$\dot{x}(t) = F(x_t) \tag{4.1}$$

we mean a continuous function $x : [-r, \omega) \rightarrow M$ such that (4.1) is satisfied for $t \in [0, \omega)$ and $\omega > 0$ is maximal. (Here and in the sequel $\dot{x}(t)$ denotes the right-hand side derivative in the case t is equal to the left end of the interval in which x is defined.) Moreover, if for every $u \in \mathbf{C}$ there is the unique solution x of (4.1) satisfying the initial condition

$$x|_{[-r, 0]} = u \tag{4.2}$$

then the right end of the domain interval of x is denoted by ω_u (i.e., $x : [-r, \omega_u) \rightarrow M$) and for $t \in [0, \omega_u)$ we define $\phi(u, t) := x_t$ (hence, in particular, $\phi(u, t)(0) = x(t)$). The mapping ϕ defined in this way is a local semiflow on the space \mathbf{C} .

Now let us consider a nonautonomous equation, i.e., an equation of the form

$$\dot{x}(t) = G(t, x_t), \tag{4.3}$$

where $G : U \rightarrow TM$ is continuous on an open subset U of $\mathbb{R} \times \mathbf{C}$ and $G(t, u) \in T_{u(0)}M$ for every $(t, u) \in U$. In this case the description of the corresponding local semiflow is slightly more complicated. Let $(\sigma, u) \in U$ and let $x : [\sigma - r, \omega) \rightarrow M$ be a solution of (4.3) (i.e., x satisfies the equation on $[\sigma, \omega)$ and $\omega > \sigma$ is maximal) which satisfies

$$x_\sigma|_{[-r, 0]} = u. \tag{4.4}$$

In this case we call x a solution of (4.3) with the initial condition (σ, u) . If for every (σ, u) there exists the unique such solution x , we define $\omega_{(\sigma,u)}$ in such a way that

$$\sigma + \omega_{(\sigma,u)} = \omega$$

(recall that ω is the right end of the interval of the existence of x) and for $t \in [0, \omega_{(\sigma,u)})$ we put

$$\psi((\sigma, u), t) := (\sigma + t, x_{\sigma+t}).$$

It is easy to check that ψ obtained in this way is a local semiflow on U .

4.2. Ważewski-type theorems for RFDEs

Our presentation of the basic results concerning the Ważewski method in Section 2.3 was purely topological, hence it also directly applies to local semiflows described in the previous section. However, since their phase-spaces are infinite-dimensional, usually the theorems given in Section 2.3 have limited applications, at least because the sphere in such a space is a retract of the ball. Therefore one should provide separate Ważewski-type theorems more suitable for retarded functional differential equations. To this aim we will follow an idea in the paper [67] by Rybakowski. Actually, it was preceded by [57], in which considered conditions were too restrictive, and [49], where the idea later used in [67] appeared in a special case. We will not provide Rybakowski’s approach in the full generality, because it would require the introduction of several new concepts, but we rather concentrate on results which can be directly used in applications.

In the current section we assume the uniqueness of the Cauchy problem for the considered equations, hence they generated local semiflows as it was described above. At first we will deal with the autonomous case, i.e., with the local flow ϕ generated by Equation (4.1) on \mathbf{C} . As in Section 3.1, let V be a polyfacial set determined by $\{\ell^i, m^j\}$, i.e.,

$$V := \{x \in M: \ell^i(x) < 0 \forall i, m^j(x) < 0 \forall j\}.$$

Recall that L^i and M^j denote the sets of zeros of ℓ^i and, respectively, m^j on the boundary of V (see (3.1) and (3.2)).

DEFINITION 4.1. The set V is called a *polyfacial set* for (4.1) if

$$F(u) \cdot \nabla \ell^i(u(0)) > 0, \quad \text{if } u(0) \in L^i \text{ and } u([-r, 0)) \subset V, \tag{4.5}$$

$$F(u) \cdot \nabla m^j(u(0)) < 0, \quad \text{if } u(0) \in M^j \text{ and } u([-r, 0)) \subset V \tag{4.6}$$

for $u \in \mathbf{C}$, $i = 1, \dots, p$, and $j = 1, \dots, q$.

EXAMPLE 4.1 (compare Example 3.1 in [67]). Consider the scalar equation

$$\dot{x} = -ax(t) - bx(t - r), \tag{4.7}$$

where $a, b \in \mathbb{R}$. If $|a| \geq |b|$ then for an arbitrary $w > 0$, the interval $(-w, w)$ is a polyfacial set for (4.7) determined by the functions $t \mapsto \pm t - w$.

In the sequel we assume that V is a polyfacial set for (4.1); in particular we assume that (4.5) and (4.6) are satisfied. Let the set E be given by the formula (3.6). Put

$$\begin{aligned} \tilde{V} &:= \{v \in \mathbf{C} : v(\tau) \in V \ \forall \tau \in [-r, 0]\}, \\ \tilde{E} &:= \{u \in \mathbf{C} : u(0) \in E, \ u(\tau) \in V \ \forall \tau \in [-r, 0]\}. \end{aligned}$$

PROPOSITION 4.1. *The set $W := \tilde{V} \cup \tilde{E}$ is a Ważewski set for the local semiflow ϕ generated by (4.1) on \mathbf{C} and its exit set W^- is equal to \tilde{E} .*

PROOF. The set W consists of two parts. It is obvious that there are no elements of W^- contained in \tilde{V} . Moreover, by (4.5), each element of \tilde{E} is in W^- , hence $W^- = \tilde{E}$. The latter set is equal to $W \cap \partial \tilde{V}$, hence it is closed in W , so (b) in Definition 2.4 holds. If the positive semitrajectory of a point in \tilde{V} reaches the boundary of \tilde{V} , the first point of intersection belongs to \tilde{E} by (4.5) and (4.6), hence also (a) is satisfied and the result follows. □

Thus all Ważewski-type theorems for semiflows stated in Section 2.3 can be applied W . Here we do not repeat them, but instead we indicate other, more useful results. In the following theorems we assume that

- $Y \subset E$,
- $Z \subset V \cup Y$,
- $\pi : \overline{Z} \cap (Z \cup Y) \rightarrow \mathbf{C}$ is a continuous map.

The first result is a counterpart of Theorem 2.1.

THEOREM 4.1. *Assume that for every $z \in \overline{Z} \cap (Z \cup Y)$,*

$$\pi(z)(0) = z, \quad \pi(z)([-r, 0]) \subset V.$$

If Y is not a strong deformation retract of $Z \cup Y$ in $V \cup Y$ then there exists a $z_0 \in Z$ such that the solution $x : [-r, \omega) \rightarrow M$ of Equation (4.1) with the initial condition $x|_{[-r, 0]} = \pi(z_0)$ satisfies

- *either $x([0, \omega)) \subset V$*
- *or else there exists $t_0 \in (0, \omega)$ such that*

$$x([0, t_0]) \subset V, \quad x(t_0) \in E \setminus Y.$$

PROOF. Assume on the contrary that the conclusion does not hold. In our notation it means that for every $z \in \overline{Z} \cap (Z \cup Y)$,

$$\pi(z) \in W^*, \quad \sigma(\pi(z)) \in Y,$$

where $\sigma : W^* \rightarrow [0, \infty)$ is the escape-time function. By Lemma 2.1 and Proposition 4.1, σ is continuous. For $y \in Z \cup Y$ and $t \in [0, 1]$ define

$$h(y, t) := \begin{cases} \phi(\pi(y), t\sigma(\pi(y)))(0), & \text{if } y \in Z, \\ y, & \text{if } y \in Y. \end{cases}$$

It is easy to verify that h satisfies the conditions required in Definition 2.6. □

The presented below counterpart of Corollary 2.1 cannot be directly derived from Theorem 4.1 because of a weaker hypothesis imposed on π . Nevertheless, its proof based on already presented arguments is straightforward.

THEOREM 4.2. *Assume that for every $z \in Z \setminus Y$,*

$$\pi(z)([-r, 0]) \subset V$$

and for every $y \in \overline{Z} \cap Y$,

$$\pi(y)(0) = y, \quad \pi(y)([-r, 0]) \subset V.$$

If Y is not a retract of $Z \cup Y$ then the conclusion of Theorem 4.1 holds.

PROOF. If the conclusion is false then the map $r : Z \cup Y \rightarrow Y$ given by the formula

$$r(y) := \begin{cases} \phi(\pi(y), \sigma(\pi(y)))(0), & \text{if } y \in Z, \\ y, & \text{if } y \in Y, \end{cases}$$

is a retraction which contradicts to the assumption. □

Essentially, the above theorems were stated in [67, Section 3]. In order to match to our presentation in Section 2.3, we strengthened them slightly (in particular, by considering the set Y). However, a direct strengthening of Theorem 4.1 in order to get a counterpart of Theorem 2.2 is not possible. A counterexample with a suitable choice of V , Z , and the maps F and π can be based on Figure 5. (Such a counterexample does not contradict to Remark 2.1.) The theorems can be extended to equations without the uniqueness property in a similar way as described in Section 3.2 (compare [67, Section 4]).

In the theorems we assumed the existence of a map π having some special properties. One can ask whether such a mapping can be constructed for a given polyfacial set V and a set Z . In practice this is always possible; if the polyfacial set is regular (see Definition 3.2) then, by Remark 3.1, \overline{V} is a topological manifold with boundary and thus it has a *collar*,

i.e., there is an embedding of $\partial V \times [0, 1]$ into \bar{V} for which $\partial V \times \{0\}$ corresponds to ∂V (compare [17, Section VI.9]). Now it is easy to construct π such that $\pi(z)$ is equal to the constant map $\tau \mapsto z$ if z is outside of the image of the embedding.

One can formulate similar theorems for the nonautonomous equation (4.3). Formally, contrary to the case of ordinary differential equations, they are not direct consequences of the results stated for the autonomous ones by attaching the equation $\dot{t} = 1$, at least because the phase-space of the local flow generated by (4.3) does not coincide with $C([-r, 0], \mathbb{R} \times M)$. However, in spite of slightly greater complexity, there are no essential problems in their formulating and proving—that can be done in the same way as above for the autonomous case.

We skip the statements of those general theorems and for simplicity concentrate on the case $M = \mathbb{R}^n$ where we assume that the domain U of the function G on the right-hand side of the equation (4.3) is equal to $\mathbb{R} \times \mathbf{C}$ and $\mathbf{C} = C([-r, 0], \mathbb{R}^n)$. (For a more general situation the reader is referred to [67].) Let V be a polyfacial set in \mathbb{R}^{n+1} determined by $\{\ell^i, m^j\}$ and let E be given by (3.6). The counterparts of (4.5) and (4.6) are

$$\begin{aligned} \frac{\partial \ell^i}{\partial t}(\sigma, x(\sigma)) + \sum_{k=1}^n \frac{\partial \ell^i}{\partial x_k}(\sigma, x(\sigma)) G_k(\sigma, x_\sigma) > 0, \\ \text{if } x_\sigma \in \mathbf{C}, (\sigma, x(\sigma)) \in L^i, (\tau, x(\tau)) \subset V \forall \tau \in [\sigma - r, \sigma], \end{aligned} \quad (4.8)$$

$$\begin{aligned} \frac{\partial m^j}{\partial t}(\sigma, x(\sigma)) + \sum_{k=1}^n \frac{\partial m^j}{\partial x_k}(\sigma, x(\sigma)) G_k(\sigma, x_\sigma) < 0, \\ \text{if } x_\sigma \in \mathbf{C}, (\sigma, x(\sigma)) \in M^j, (\tau, x(\tau)) \subset V \forall \tau \in [\sigma - r, \sigma], \end{aligned} \quad (4.9)$$

The following result resembles Theorems 4.1 and 4.2.

THEOREM 4.3. *Assume that (4.8) and (4.9) are satisfied and one of the following conditions hold:*

(i) *for every $(\sigma, z) \in \bar{Z} \cap (Z \cup Y)$,*

$$\pi((\sigma, z))(0) = z, \quad (\sigma + \tau, \pi(\sigma, z)(\tau)) \in V \forall \tau \in [-r, 0],$$

and Y is not a strong deformation retract of $Z \cup Y$ in $V \cup Y$,

(ii) *for every $(\sigma, z) \in Z \setminus Y$,*

$$\pi(\sigma, z)([-r, 0]) \subset V$$

and for every $(\sigma, y) \in \bar{Z} \cap Y$,

$$\pi((\sigma, y))(0) = z, \quad (\sigma + \tau, \pi(\sigma, y)(\tau)) \in V \forall \tau \in [-r, 0],$$

and, moreover, Y is not a retract of $Z \cup Y$.

Then there exists a $(\sigma_0, z_0) \in Z$ such that the solution $x : [-r + \sigma_0, \omega) \rightarrow \mathbb{R}^n$ of the equation (4.1) with the initial condition $x_{\sigma_0}|_{[-r, 0]} = \pi(\sigma_0, z_0)$ satisfies

- either $(t, x(t)) \subset V$ for every $t \in [\sigma_0, \omega)$
- or else there exists $t_0 \in (\sigma_0, \omega)$ such that

$$(t, x(t)) \in V \quad \forall t \in [\sigma_0, t_0), \quad (t_0, x(t_0)) \in E \setminus Y.$$

PROOF. One can follow the ideas of the proofs of Theorems 4.1 and 4.2. Define

$$\begin{aligned} \tilde{V} &:= \{(\sigma, u) \in \mathbb{R} \times \mathbf{C} : (\sigma + \tau, u(\tau)) \in V \quad \forall \tau \in [-r, 0]\}, \\ \tilde{E} &:= \{(\sigma, u) \in \mathbb{R} \times \mathbf{C} : (\sigma, u(0)) \in E, (\sigma + \tau, u(\tau)) \in V \quad \forall \tau \in [-r, 0]\}. \end{aligned}$$

Their union is a Ważewski set for the local semiflow ψ on $\mathbb{R} \times \mathbf{C}$ described in the previous section and the continuity of its escape-time function is used in definitions of the suitable mappings. Details are straightforward and are omitted here. □

The equation considered in the following two examples of application of Theorem 4.3 is taken from [67, Example 3.2]. Similar applications for ordinary differential equation were given in Examples 1.1 and 1.2.

EXAMPLE 4.2. In the planar equation

$$\begin{aligned} \dot{x}(t) &= ax(t) + bx(t - r) + f(t, x_t, y_t), \\ \dot{y}(t) &= -cy(t) + dy(t - r) + g(t, x_t, y_t) \end{aligned} \tag{4.10}$$

let $a, c > 0$ and let

$$(f, g) : \mathbb{R} \times \mathbf{C} \times \mathbf{C} \rightarrow \mathbb{R}^2,$$

where $\mathbf{C} = C([-r, 0], \mathbb{R})$, be a continuous map. Assume that (4.10) satisfies the uniqueness of the Cauchy problem,

$$|f(t, u, v)| < |a| - |b|$$

for all $(t, u, v) \in \mathbb{R} \times \mathbf{C} \times \mathbf{C}$ for which

$$\begin{aligned} |u(0)| &= 1, & |v(0)| &\leq 1, \\ |u(\tau)| &< 1, & |v(\tau)| &< 1 \quad \forall \tau \in [-r, 0), \end{aligned}$$

and

$$|g(t, u, v)| < |c| - |d|$$

for all $(t, u, v) \in \mathbb{R} \times \mathbb{C} \times \mathbb{C}$ for which

$$\begin{aligned} |u(0)| &\leq 1, & |v(0)| &= 1, \\ |u(\tau)| &< 1, & |v(\tau)| &< 1 \quad \forall \tau \in [-r, 0]. \end{aligned}$$

Let the sets V , E , and Z be the same as in Example 1.1, i.e., they are given by, respectively, (1.7), (1.8), and (1.9) (see also Figure 2). V is a polyfacial set for (4.10). Define $\pi : Z \cup E \rightarrow \mathbb{C} \times \mathbb{C}$ by

$$\pi(t, x, y)(\tau) := \left(\frac{r + \tau}{r}x, y \right)$$

for $(t, x, y) \in Z \cup E$ and $\tau \in [-r, 0]$. By Theorem 4.3 we conclude that there is an $x_0 \in (-1, 1)$ such that the graph of the solution of (4.10) starting at $(0, \pi(0, x_0, 0))$ is contained in V .

EXAMPLE 4.3. We associate the boundary value problem (1.10) to Equation (4.10) in Example 4.2. As in Example 1.2, we define V , E , Z , and Y by, respectively (1.11), (1.12), (1.9), and (1.13). Recall, that those sets are shown on Figure 3. Let π be the mapping defined in Example 4.2. By Theorem 4.3 we conclude the existence of a solution of the problem (4.10), (1.10) which starts at $(0, \pi(0, x_0, 0))$ for some $x_0 \in (-1, 1)$.

5. Some topological concepts

In order to state variants of the Ważewski theorem, we have already defined the notion of retract and its modifications. In this section we recall several other topological notions and results which will be used in description of properties of the sets of solutions obtained by the Ważewski method.

5.1. Topological pairs, quotient spaces, and pointed spaces

By a *topological pair* we mean a pair (X, A) consisting of a topological space X and its subset A . If A is closed in X then (X, A) is called a *closed pair*. If $x_0 \in X$, we frequently write (X, x_0) for the topological pair $(X, \{x_0\})$. Let (X, A) and (Y, B) be topological pairs. We write $f : (X, A) \rightarrow (Y, B)$ if f is continuous map $X \rightarrow Y$ and $f(A) \subset B$.

Now we recall the notion of quotient space. We impose a special attention to the case in which the empty space is involved. Let (X, A) be a topological pair.

DEFINITION 5.1. The *quotient space* X/A is the set whose elements are all points of $X \setminus A$ and the set A (denoted by $[A]$ in order to avoid confusions), i.e.,

$$X/A := (X \setminus A) \cup \{[A]\},$$

endowed with the topology for which $U \subset X/A$ is open if and only if the set $\{x \in X: [x] \in U\}$ is open in X , where

$$[x] := \begin{cases} x, & \text{if } x \in X \setminus A, \\ [A], & \text{if } x \in A. \end{cases}$$

It follows that the *quotient map*

$$q : X \ni x \rightarrow [x] \in X/A$$

is continuous. By definition, X/\emptyset is equal to $X \cup \{\emptyset\}$ and its topology is equal to the direct sum topology of X and the one-point space $\{\emptyset\}$. In particular, \emptyset/\emptyset is equal to $\{\emptyset\}$. Since $[A]$ is distinguished in X/A in a canonical way, in order to simplify the notation, for an arbitrary pair (X, A) we write shortly $(X/A, *)$ instead of $(X/A, [A])$.

For presentation of results involving quotient spaces we use the Čech cohomology functor $\check{H}^* = \{\check{H}^q\}_{q \in \mathbb{Z}}$ having coefficients in a fixed commutative ring-with-unit R . We recall that it is isomorphic to the Alexander–Spanier cohomology functor (compare [71]).

REMARK 5.1. By the strong excision of the Čech cohomology, if (X, A) is a closed pair then the quotient map induces an isomorphism

$$\check{H}^*(q) : \check{H}^*(X/A, *) \xrightarrow{\cong} \check{H}^*(X, A).$$

By a *pointed space* we mean a topological pair (X, x_0) , where $x_0 \in X$. In this case x_0 is called the *base point*. For example, $(X/A, *)$ is a pointed space with the base point $*$ equal to $[A]$. Let (X, x_0) and (Y, y_0) be two pointed spaces. In this case $f : (X, x_0) \rightarrow (Y, y_0)$ means $f : X \rightarrow Y$ continuous such that $f(x_0) = y_0$. We put

$$X \vee Y := X \times \{y_0\} \cup \{x_0\} \times Y$$

and define the *wedge sum* of (X, x_0) and (Y, y_0) by

$$(X, x_0) \vee (Y, y_0) := (X \vee Y, (x_0, y_0)).$$

Similarly, we put

$$X \wedge Y := X \times Y / (X \vee Y),$$

$$(X, x_0) \wedge (Y, y_0) := (X \wedge Y, *)$$

and call $(X, x_0) \wedge (Y, y_0)$ the *smash product* of (X, x_0) and (Y, y_0) .

5.2. Homotopy types

Recall that maps $f, g : X \rightarrow Y$ are *homotopic* (denoted $f \simeq g$) if for some continuous map $h : X \times [0, 1] \rightarrow Y$, f is equal to $x \mapsto h(x, 0)$ and g is equal to $x \mapsto h(x, 1)$. If, moreover,

$f, g : (X, x_0) \rightarrow (Y, y_0)$ then they are called *pointed-homotopic* (denoted $f \simeq_* g$) if the map h additionally satisfies $h(x_0, t) = y_0$ for every $t \in [0, 1]$.

DEFINITION 5.2. We say that topological spaces X and Y have the same *homotopy type* (and we write $X \simeq Y$) if for some maps $f : X \rightarrow Y$ and $g : Y \rightarrow X$ (called *homotopy equivalences*),

$$g \circ f \simeq \text{id}_X, \quad f \circ g \simeq \text{id}_Y.$$

We say that the pointed spaces (X, x_0) and (Y, y_0) have the same *pointed homotopy type* (we write $(X, x_0) \simeq_* (Y, y_0)$) if there exist $f : (X, x_0) \rightarrow (Y, y_0)$ and $g : (Y, y_0) \rightarrow (X, x_0)$ such that

$$g \circ f \simeq_* \text{id}_X, \quad f \circ g \simeq_* \text{id}_Y.$$

The *absolute homotopy type* (shortly: *homotopy type*) of X is the equivalence class of X in the relation \simeq . It is denoted by $[X]$. Similarly, the *pointed homotopy type* of (X, x_0) is the equivalence class of (X, x_0) in the relation \simeq_* and is denoted by $[X, x_0]$.

Obviously, $[X, x_0]$ is a more restrictive class of spaces than $[X]$. Since a homology or cohomology functor H is homotopy invariant, we define

$$H[X] := H(X), \quad H[X, x_0] := H(X, x_0).$$

One can prove that the following definitions of the *wedge sum* and *smash product* of homotopy types are correctly stated:

$$\begin{aligned} [X, x_0] \vee [Y, y_0] &:= [(X, x_0) \vee (Y, y_0)], \\ [X, x_0] \wedge [Y, y_0] &:= [(X, x_0) \wedge (Y, y_0)]. \end{aligned}$$

We distinguish the *trivial pointed homotopy type*:

$$\bar{0} := [\{[\emptyset]\}, [\emptyset]],$$

i.e., the homotopy type of a pointed one-point space, which is the neutral element with respect to the wedge sum.

REMARK 5.2. There is no inverse to a nontrivial pointed homotopy type with respect to the wedge sum, i.e.,

$$[X, x_0] \vee [Y, y_0] = \bar{0}$$

implies

$$[X, x_0] = \bar{0}, \quad [Y, y_0] = \bar{0}.$$

Indeed, if there is a continuous map $F : X \vee Y \times [0, 1] \rightarrow X \vee Y$ such that

$$F((x, y), 0) = (x, y), \quad F((x, y), 1) = F((x_0, x_0), t) = (x_0, x_0)$$

for every t, x, y then the map $G : X \times [0, 1] \rightarrow X$ defined by

$$G(x) := \begin{cases} \pi F((x, y_0), t), & \text{if } F((x, y_0), t) \in X \times \{y_0\}, \\ x_0, & \text{otherwise,} \end{cases}$$

where $\pi : X \times Y \rightarrow X$ denotes the projection, provides

$$(X, x_0) \simeq_* (\{x_0\}, x_0).$$

The following simple lemma is useful in the Ważewski method.

LEMMA 5.1. *If A is a strong deformation retract of X then*

$$[X/A, *] = \bar{0}.$$

In the following example we illustrate the difference between the absolute and pointed homotopy types.

EXAMPLE 5.1. The unit zero- and one-dimensional spheres S^0 and S^1 are, respectively, the set $\{-1, 1\}$ and the circle $\{x : |x| = 1\}$ in \mathbb{C} . They naturally provide pointed spaces $(S^0, 1)$ and $(S^1, 1)$. By definition, $S^0 \vee S^1$ is homeomorphic to the disjoint union of S^1 and a one-point space, hence it is homeomorphic to S^1/\emptyset and

$$[S^0 \vee S^1] = [S^1/\emptyset].$$

On the other hand, each homotopy equivalence $S^0 \vee S^1 \rightarrow S^1/\emptyset$ transforms the base point $(1, 1)$ of $(S^0, 1) \vee (S^1, 1)$ to a point in the other component of S^1/\emptyset then $[\emptyset]$, hence

$$[S^0, 1] \vee [S^1, 1] = [(S^0, 1) \vee (S^1, 1)] \neq [S^1/\emptyset, *].$$

5.3. Absolute neighborhood retracts

We recall the topological notions of absolute and Euclidean neighborhood retracts.

DEFINITION 5.3 (compare [14,33]). A metrizable space X is called an *absolute neighborhood retract* (shortly: ANR) if there is an open set U in a normed space E and a map $h : X \rightarrow E$ which is a homeomorphism onto its image $h(X)$ such that $h(X)$ is a retract of U .

REMARK 5.3. There is an equivalent definition: A metrizable space X is an ANR if and only if for each closed subset A of a metrizable space W and every continuous map $f: A \rightarrow X$ there exists a neighborhood U of A in W and a continuous map $F: U \rightarrow X$ such that $F|_A = f$ (compare [14, Theorem IV(4.2)(ii)]).

We refer to [14] for other properties of ANRs.

DEFINITION 5.4 (compare [28]). A metrizable space X is called an *Euclidean neighborhood retract* (shortly: ENR) if there is an $n \in \mathbb{N}$, an open set U in \mathbb{R}^n , and a map $h: X \rightarrow \mathbb{R}^n$ which is a homeomorphism onto its image $h(X)$ such that $h(X)$ is a retract of U .

The class of ENRs coincides with the class of locally compact, separable, and finite-dimensional ANRs. Examples of ENRs include all compact polyhedra and manifolds with boundary. The Hilbert cube is a compact ANR which is not an ENR.

5.4. Lusternik–Schnirelmann category

We provide the concept of the Lusternik–Schnirelmann category for topological pairs, which appears to be very convenient in connection to the Ważewski method. At first we recall the notion of contractibility.

DEFINITION 5.5. A set $A \subset X$ is called *contractible in X* if there exists a continuous map $h: A \times [0, 1] \rightarrow X$ such that $h(x, 0) = x$ for every $x \in A$ and $h(x, 1) = h(y, 1)$ for every $x, y \in A$.

Notice that the above definition is also valid also for $A = \emptyset$. Let (X, Y) be a closed pair. Motivated by the definition posed by Reeken, Fournier, and Willem (compare [31]) we put

DEFINITION 5.6. The *relative category* $\text{cat}_{X,Y}(A)$ of a closed set $A \subset X$ is an element of $\mathbb{N} \cup \{\infty\}$ such that

$$\begin{aligned} \text{cat}_{X,Y}(A) &:= 0, && \text{if } Y \text{ is a strong deformation retract of } A \cup Y \text{ in } X. \\ \text{cat}_{X,Y}(A) &\leq n, && \text{if there exist closed sets } A_i \subset A, i = 0, \dots, n, \text{ such that} \\ &&& A = \bigcup_{i=0}^n A_i, \\ &&& A_i \text{ is contractible in } X \text{ for } i = 1, \dots, n, \text{ and} \\ &&& Y \text{ is a strong deformation retract of } A_0 \cup Y \text{ in } X. \end{aligned}$$

(Compare Definition 2.6 for the notion of a strong deformation retract in a space.)

Formally, we did not exclude any possibility in which the empty set appears. In particular, for closed $A \subset X$ we define

$$\text{cat}_X(A) := \text{cat}_{X,\emptyset}(A).$$

It follows that if $X \neq \emptyset$ then $\text{cat}_X(A)$ is the minimal number of closed contractible in X subsets of A which cover A (since $A_0 = \emptyset$) or, if such a number does not exist, it is equal to ∞ .

DEFINITION 5.7. Define

$$\text{cat}(X, Y) := \text{cat}_{X,Y}(X),$$

$$\text{cat}(X) := \text{cat}_X(X)$$

and call them the *category of* (X, Y) and, respectively the *category of* X .

It is easy to check that for a closed $A \subset X$,

$$\text{cat}_X(A) \leq \text{cat}(A), \tag{5.1}$$

$$\text{cat}_{X,Y}(A) \leq \text{cat}_X(A) \leq \text{cat}_{X,Y}(A) + \text{cat}_X(Y). \tag{5.2}$$

In particular,

$$\text{cat}(X, Y) \geq \text{cat}(X) - \text{cat}_X(Y) \geq \text{cat}(X) - \text{cat}(Y) \tag{5.3}$$

and if x_0 is a point in X then

$$\text{cat}_{X,x_0}(A) \leq \text{cat}_X(A) \leq \text{cat}_{X,x_0}(A) + 1. \tag{5.4}$$

EXAMPLE 5.2. In the notation used in Example 5.1,

$$\text{cat}(S^1) = \text{cat}(S^1/\emptyset, *) = \text{cat}((S^0, 1) \vee (S^1, 1)) = 2, \quad \text{cat}(S^1/\emptyset) = 3.$$

It follows immediately by definition that the category is an invariant of the absolute and pointed homotopy types. Hence we can put the following definitions:

DEFINITION 5.8. The categories of the homotopy types are defined as

$$\text{cat}[X] := \text{cat}(X),$$

$$\text{cat}[X, x_0] := \text{cat}(X, x_0).$$

We list the basic properties of the category.

PROPOSITION 5.1 (compare [31]). *Let A and B be closed subsets of X .*

- (i) *If $A \subset B$ then $\text{cat}_{X,Y}(A) \leq \text{cat}_{X,Y}(B)$.*
- (ii) *$\text{cat}_{X,Y}(A \cup B) \leq \text{cat}_{X,Y}(A) + \text{cat}_X(B)$.*
- (iii) *If there exists a continuous map $h : A \times [0, 1] \rightarrow X$ such that $h(x, 0) = x$ for $x \in A$, $h(x, t) = x$ for $x \in A \cap Y$ and $t \in [0, 1]$ then*

$$\text{cat}_{X,Y}(h_1(A)) \leq \text{cat}_{X,Y}(A).$$

(iv) *If both X and Y are ANRs then there exists a closed neighborhood U of A such that*

$$\text{cat}_{X,Y}(U) = \text{cat}_{X,Y}(A).$$

PROOF. Proofs of (i), (ii), and (iii) are immediate. As for (iv), we refer to [31, Proposition 2.9]. □

PROPOSITION 5.2. *If (X, A) is a closed pair of ANRs then*

$$\text{cat}(X, A) \geq \text{cat}(X/A, *) \geq \text{cat}(X/A) - 1.$$

PROOF. We can assume that $\text{cat}(X, A) = n < \infty$. Let $A_i, i = 0, \dots, n$, be a closed covering of X such that $A \subset A_0$, A is a strong deformation retract of A_0 , and A_i are contractible in X for $i \geq 1$. Since X and A are ANRs, as in the proof of [31, Proposition 2.9] one can find a closed neighborhood U_0 of A_0 for which A is a strong deformation retract. For $i = 1, \dots, n$ define A'_i as $A_i \setminus \text{int} U_0$, hence $A'_i \cap A = \emptyset$. Using the subsets $U_0/A, A'_1, \dots, A'_n$ of X/A one gets

$$\text{cat}(X/A, *) \leq n,$$

hence the left inequality follows. The right-hand inequality is given in (5.4). □

5.5. Cup-length

Here we use the cup-product (denoted by \smile) in the Čech cohomologies (compare [28] for results which concern that notion and which we apply in the sequel). We provide the notion of cup-length in the context of pair of spaces, compare [31, Definition 3.2]. Notice that in our definition, the cup-length of a pair is shifted by one with respect to the cup-length considered in that paper.

DEFINITION 5.9. The *cup-length* of a topological pair (X, Y) is an element $\ell(X, Y)$ of $\mathbb{N} \cup \{\infty\}$ which satisfies

$$\begin{aligned} \ell(X, Y) = 0, & \quad \text{if } \check{H}^*(X, Y) = 0, \\ \ell(X, Y) = 1, & \quad \text{if } \check{H}^0(X, Y) \neq 0, \check{H}^q(X) = 0 \text{ for } q \geq 1, \\ \ell(X, Y) \geq n, & \quad \text{if there exist } q \geq 0, v \in \check{H}^q(X, Y), q_i \geq 1, \text{ and } u_i \in \check{H}^{q_i}(X) \\ & \quad \text{for } i = 1, \dots, n - 1 \text{ such that } v \smile u_1 \smile \dots \smile u_{n-1} \neq 0. \end{aligned}$$

We write $\ell(X) := \ell(X, \emptyset)$. It follows $\ell(\emptyset) = 0, \ell(X) = 1$ if $X \neq \emptyset$ and $\check{H}^q(X) = 0$ for $q \geq 1$, and $\ell(X) \geq n$ if there exists $q_i \geq 1$ and $u_i \in \check{H}^{q_i}(X), i = 1, \dots, n - 1$, such that

$u_1 \smile \cdots \smile u_{n-1} \neq 0$. Indeed, it suffices to put $v = 1 \in \check{H}^0(X, \emptyset)$. Moreover, if $x_0 \in X$ then

$$\ell(X, \{x_0\}) \leq \ell(X) \leq \ell(X, \{x_0\}) + 1, \tag{5.5}$$

since $\check{H}^q(X, \{x_0\}) = \check{H}^q(X)$ for $q \geq 1$. Moreover, it follows that the cup-length is an invariant of the Čech cohomology ring of (X, x_0) , hence also of the pointed homotopy type $[X, x_0]$. Thus we can put

DEFINITION 5.10. The cup-lengths of the homotopy types are defined as

$$\begin{aligned} \ell[X] &:= \ell(X), \\ \ell[X, x_0] &:= \ell(X, x_0). \end{aligned}$$

PROPOSITION 5.3. If (X, A) is a closed pair then

$$\ell(X, A) \geq \ell(X/A, *) \geq \ell(X/A) - 1.$$

PROOF. Assume $\ell(X/A, *) \geq n$. The diagram

$$\begin{array}{ccccccc} \check{H}^*(X/A, *) \otimes \check{H}^*(X/A) \otimes \cdots \otimes \check{H}^*(X/A) & \xrightarrow{\smile} & \check{H}^*(X/A, *) & & & & \\ \cong \downarrow & & \downarrow & & \downarrow & & \downarrow \cong \\ \check{H}^*(X, A) \otimes \check{H}^*(X) \otimes \cdots \otimes \check{H}^*(X) & \xrightarrow{\smile} & \check{H}^*(X, A) & & & & \end{array}$$

with the vertical lines induced by the quotient map, is commutative. By Remark 5.1 and the commutativity, if

$$v \smile u_1 \smile \cdots \smile u_{n-1} \neq 0$$

in $\check{H}^*(X/A, *)$, then the corresponding element in $\check{H}^*(X, A)$ is also nonzero, hence $\ell(X, A) \geq n$ and the left inequality follows. The right-hand inequality is given in (5.5). \square

The most important result concerning the notion of cup-length relates it to the Lusternik–Schnirelmann category.

PROPOSITION 5.4 (compare Theorem 3.6 in [31]). If (X, Y) is a closed pair then

$$\text{cat}(X, Y) \geq \ell(X, Y).$$

5.6. Lefschetz theorem and the fixed point index

Recall that if $f : (X, A) \rightarrow (X, A)$ is a continuous map, H is a homology or cohomology functor over \mathbb{Q} , and the vector-spaces $H_q(X, A)$ are finitely dimensional and equal to zero for almost all q then the *Lefschetz number* of f (with respect to H) is defined as

$$\Lambda(f) := \sum_{q=0}^{\infty} (-1)^q \operatorname{tr} H_q(f),$$

where $\operatorname{tr} H_q(f)$ denotes the trace of the endomorphism $H_q(f)$ of $H_q(X, A)$. If f is equal to the identity on (X, A) then its Lefschetz number is denoted by $\chi(X, A)$ and is called the Euler characteristic of (X, A) (with respect to H), i.e.,

$$\chi(X, A) = \sum_{q=0}^{\infty} (-1)^q \dim H_q(X, A).$$

If (X, A) is a pair of compact ANRs then the Lefschetz number is always defined and independent of the choice of H , and

$$\Lambda(f) = \Lambda(f|_X) - \Lambda(f|_A),$$

where $f|_X : X \rightarrow X$ and $f|_A : A \rightarrow A$ are the restrictions of f . In particular,

$$\chi(X, A) = \chi(X) - \chi(A).$$

Since homologies and cohomologies are homotopy invariants, we define

$$\begin{aligned} \chi[X] &:= \chi(X), \\ \chi[X, x_0] &:= \chi(X, x_0) = \chi[X] - 1. \end{aligned}$$

PROPOSITION 5.5. *If (X, A) is a closed pair and the Euler characteristic with respect to the Čech cohomologies $\check{\chi}(X, A)$ is defined then*

$$\check{\chi}(X, A) = \check{\chi}(X/A, *) = \check{\chi}(X/A) - 1.$$

Moreover, if X and A are compact ENRs then X/A is also a compact ENR and

$$\chi(X, A) = \chi(X/A, *) = \chi(X/A) - 1$$

does not depend on the choice of homology or cohomology.

PROOF. This is a consequence of Remark 5.1 and [28, Chapter IV.8]. □

The Lefschetz number is used in formulation of the following well-known result:

PROPOSITION 5.6 (Lefschetz Fixed Point Theorem). *If X is a compact ANR, $f : X \rightarrow X$ is a continuous map, and $\Lambda(f) \neq 0$ then f has a fixed point.*

Assume that X is an ENR. For a continuous map $f : D \rightarrow X$, where $D \subset X$, define its set of fixed points as

$$\text{Fix}(f) := \{x \in D: f(x) = x\}.$$

DEFINITION 5.11. A set P is called an *isolated set of fixed points* of f if it is compact and there exists an open set U in X such that $U \subset D$ and

$$P = U \cap \text{Fix}(f).$$

If Q is an isolated set of fixed points of $g : D \rightarrow X$, we write $(f, P) \simeq (g, Q)$ (and call (f, P) *homotopic to* (g, Q)) if for every $t \in [0, 1]$ there exist a map $f_t : D \rightarrow X$ such that

$$F : D \times [0, 1] \ni (x, t) \rightarrow (f_t(x), t) \in X \times [0, 1]$$

is continuous and there exists an isolated set P^* of fixed points of F such that $f_0 = f$, $f_1 = g$, $P = \{x: (x, 0) \in P^*\}$, and $Q = \{x: (x, 1) \in P^*\}$.

To such an isolated set P one can associate an integer number $\text{ind}(f, P)$, called the *fixed point index*, see the book [28]. We use a slightly different notation with respect to that in the book of Dold; our $\text{ind}(f, P)$ means the same as the index of $f|_U$ in [28]. Below we list its properties:

PROPOSITION 5.7 (compare [28]).

- (i) (Solvability) *If $\text{ind}(f, P) \neq 0$ then $P \neq \emptyset$.*
- (ii) (Additivity) *If P and Q are isolated sets of fixed points of f and $P \cap Q = \emptyset$ then*

$$\text{ind}(f, P \cup Q) = \text{ind}(f, P) + \text{ind}(f, Q).$$

- (iii) (Multiplicativity) *If $f : X \rightarrow X$ and $g : Y \rightarrow Y$, P and Q are isolated sets of fixed points of f and g , respectively, then*

$$\text{ind}(f \times g, P \times Q) = \text{ind}(f, P) \text{ind}(g, Q).$$

- (iv) (Homotopy Invariance) *If $(f, P) \simeq (g, Q)$ then $\text{ind}(f, P) = \text{ind}(g, Q)$.*
- (v) (Commutativity) *If $f : D \rightarrow X'$ and $f' : D' \rightarrow X$, where $D \subset X$ and $D' \subset X'$, and P is an isolated set of fixed points of $f' \circ f$ then $f(P)$ is an isolated set of fixed points of $f \circ f'$ and*

$$\text{ind}(f' \circ f, P) = \text{ind}(f \circ f', f(P)).$$

- (vi) (Lefschetz Property) *If X is compact and $f : X \rightarrow X$ then*

$$\text{ind}(f, \text{Fix } f) = \Lambda(f).$$

6. Properties of the asymptotic parts of Ważewski sets

Roughly speaking, abstract Ważewski-type theorems provide sufficient conditions for

$$W \setminus W^* \neq \emptyset$$

if W is a Ważewski set. Here we consider the question what additional information on that asymptotic part can be obtained from the properties of W and W^- ; in particular whether it contains stationary or periodic points and what is its topology. In this section we concentrate on qualitative results valid for local semiflows. For some more accurate results which are easier to handle if local flows are considered we refer to the next section.

6.1. Estimates on the category of the asymptotic part

We assume that ϕ be a local semiflow on X . It seems that the paper [63] of Pożniak was the first one in which the notion of category appeared in the context of the Ważewski method and Conley index. We base on some ideas from that paper.

THEOREM 6.1. *Let $W \subset X$ be a Ważewski set, Assume that both W and W^- are ANRs closed in X and Z is a closed subset of W . Then*

$$\text{cat}_W(Z \setminus W^*) \geq \text{cat}_{W, W^-}(Z).$$

PROOF. $Z \setminus W^*$ is closed by Lemma 2.1. By Proposition 5.1, there exists U , a closed neighborhood of $Z \setminus W^*$ in W such that $\text{cat}_W(W \setminus W^*) = \text{cat}_W(U)$. Put $V := Z \setminus \text{int } U$ (where int denotes the interior relative to W). It follows by Proposition 5.1

$$\text{cat}_W(Z \setminus W^*) = \text{cat}_W(U) = \text{cat}_W(U) + \text{cat}_{W, W^-}(V) \geq \text{cat}_{W, W^-}(Z)$$

since $Z = U \cup V$ and $V \subset W^*$, hence W^- is a strong deformation retract of $V \cup W^-$ in W . □

Under the imposed conditions on W and W^- , the above theorem can be regarded as an extension of Corollary 2.3, since if W^- is not a strong deformation retract of $Z \cup W^-$ in W then, by definition, $\text{cat}_{W, W^-}(Z) \geq 1$, hence $\text{cat}(Z \setminus W^*) \geq 1$, hence $Z \setminus W^*$ is nonempty.

COROLLARY 6.1. *If W is a Ważewski set and W and W^- are closed ANRs then*

$$\text{cat}_W(W \setminus W^*) \geq \text{cat}(W, W^-).$$

Recall that $\text{cat}(W, W^-)$ can be estimated using (5.3) or Proposition 5.2. Another estimate using the notion of cup-length is given by Proposition 5.4.

6.2. Stationary points of gradient-like local semiflows

Let ϕ be a local semiflow on X .

DEFINITION 6.1. $g : X \rightarrow \mathbb{R}$ is called a *Liapunov function* for ϕ provided it is decreasing along nonconstant trajectories, i.e.,

$$g(\phi_s(x)) > g(\phi_t(x))$$

if $s < t$ whenever x is not a stationary point. ϕ is called a *gradient-like* local semiflow if there exists a Liapunov function for ϕ .

An example which justifies the name is a gradient local flow on a Riemannian manifold, i.e., the local flow generated by

$$\dot{x} = -\nabla g(x) \tag{6.1}$$

for a C^1 -class function g . In this case stationary points are critical points of g .

It is not difficult to prove the following result:

PROPOSITION 6.1. *If ϕ is gradient-like then each nonempty ω -limit set consists of stationary points.*

By Corollary 2.5, it immediately follows:

COROLLARY 6.2. *If a local semiflow ϕ on X is gradient-like, $W \subset X$ is a compact Ważewski set and W^- is not a strong deformation retract of W then W contains a stationary point of ϕ .*

6.3. Stationary points of local semiflows in the general case

Results on the existence of stationary points of semiflows without any gradient-like structure can be obtained using fixed points theorems. The most useful for our purposes is the Lefschetz theorem. It is applied in a proof of the following result:

THEOREM 6.2 (compare Corollary 1 in [73]). *If ϕ is a local semiflow on X , W and W^- are compact ANRs in X , and*

$$\chi(W, W^-) = \chi(W) - \chi(W^-) \neq 0$$

then W contains a stationary point of ϕ .

PROOF. *Step 1.* At first we prove that for every $T > 0$ there exists a point $x \in W$ such that $\phi_T(x) = x$. Let S^1 be the unit circle in the complex plane \mathbb{C} . In the topological direct sum

$$W \amalg (W^- \times S^1),$$

i.e., a disjoint union of W and $W^- \times S^1$ endowed with the inductive topology, identify each point of $W^- \subset W$ with a point of $W^- \times S^1$ via the map $j : w \mapsto (w, 1)$. The resulting quotient space is the adjunction

$$\tilde{W} := W \cup_j (W^- \times S^1).$$

Define a semiflow ψ on \tilde{W} by

$$\psi(z, t) := \begin{cases} \phi(z, t), & \text{if } z \in W \text{ and } \sigma^+(z) \geq t, \\ (\phi(z, \sigma^+(z)), \exp(\pi i(t - \sigma^+(z))/T)), & \text{if } z \in W \text{ and } \sigma^+(z) \leq t, \\ (x, \alpha \exp(\pi i t/T)), & \text{if } z = (x, \alpha) \in W^- \times S^1. \end{cases}$$

The set \tilde{W} is a compact ANR since W , W^- , and $W^- \times S^1$ are ANRs, and

$$\chi(\tilde{W}) = \chi(W) + \chi(W^- \times S^1) - \chi(W^-) = \chi(W) - \chi(W^-) \neq 0.$$

Since $\phi_T \simeq \text{id}$, there exists $z \in \tilde{W}$ such that $\psi_T(z) = z$ by the Lefschetz fixed point theorem (Proposition 5.6). It follows by the definition of ψ that $\psi_T(z) = z$ if and only if

$$z \in W, \quad \phi_T(z) = z, \quad \phi^+(z) = \phi(z, [0, T]) \subset W,$$

hence the required conclusion follows.

Step 2. Now we can use a standard argument to prove that ϕ has a stationary point in W (compare [32, Proposition 7(4.8)]). By Step 1, there exists $x_n \in \tilde{W}$ such that $\phi(x_n, 2^{-n}) = x_n$. An accumulation point of the sequence $\{x_n\}$ is a stationary point of ϕ , hence the result follows. □

7. Isolating blocks and segments

We continue the series of results on properties of the asymptotic part of a Ważewski set. Here we additionally assume that the considered local semiflow is a local flow and the Ważewski set is an isolating block. These assumptions enable us to provide various quantitative properties of the invariant part of the set in an easier way.

7.1. Isolating blocks and their structure

Let ϕ be a local flow on a metrizable space X . At first we should fix terminology concerning behavior of ϕ with respect to a given subset of X . Recall, that we have already defined the exit set and the asymptotic part in Section 2.1, the extended escape-time function in Section 2.2, and we mentioned on an invariant part in Section 1.3. Let $Z \subset X$. We provide

a list of notions related to Z which will be of our interest (for the full account we repeat the definitions of Z^- , $\text{Inv}(Z)$, and σ^+). Define the sets

$$\begin{aligned} Z^- &:= \{x \in Z: \phi(x, [0, t]) \not\subset Z \ \forall t > 0\}, \\ Z^+ &:= \{x \in Z: \phi(x, [-t, 0]) \not\subset Z \ \forall t > 0\}, \\ \text{Inv}^\pm(Z) &:= \{x \in Z: \phi^\pm(x) \subset Z\}, \\ \text{Inv}(Z) &:= \text{Inv}^-(Z) \cap \text{Inv}^+(Z), \end{aligned}$$

and functions $\sigma^\pm: Z \rightarrow [0, \infty]$ by

$$\begin{aligned} \sigma^+(x) &:= \sup\{t \geq 0: \phi(x, [0, t]) \subset Z\}, \\ \sigma^-(x) &:= \sup\{t \geq 0: \phi(x, [-t, 0]) \subset Z\}. \end{aligned}$$

Obviously, $\text{Inv}^+(Z)$ is the asymptotic part of Z ; it is also called the *positive invariant part*, and $\text{Inv}(Z)$ is the *invariant part of Z* . Moreover, $\text{Inv}^-(Z)$ is called the *negative invariant part* and Z^+ is called the *entrance set* of Z . (It should be pointed out that all the above notions are defined with respect to a fixed ϕ and Z . In fact, a more proper notation should indicate on ϕ , for example $\text{Inv}_\phi(Z)$ instead of $\text{Inv}(Z)$, $\sigma_{\phi, Z}^\pm$ instead of σ^\pm , etc. Nevertheless, for simplicity we avoid that notation whenever it does not lead to confusions.)

In Section 1.3, it was given a rough definition of the concept of isolating block. Here we state it in a slightly more general context.

DEFINITION 7.1. A set $B \subset X$ is called an *isolating block* if

$$B = \overline{\text{int } B},$$

B , B^- , and B^+ are compact, and for every $x \in \partial B \setminus (B^- \cup B^+)$,

$$\begin{aligned} \sigma^-(x) < \infty, \quad \sigma^+(x) < \infty, \\ \phi(x, [-\sigma^-(x), \sigma^+(x)]) \subset \partial B. \end{aligned}$$

(In practice, one usually considers isolating blocks without sliding on the boundary, i.e., $\partial B = B^+ \cup B^-$). By Proposition 2.1 and Lemma 2.2 we get immediately the following properties of isolating blocks:

PROPOSITION 7.1. *If B is an isolating block then*

- (i) *B is a Ważewski set for both ϕ and its reverse obtained by the transformation $t \mapsto -t$ of time,*
- (ii) *the functions σ^\pm are continuous.*

In the sequel we assume that B is an isolating block. In particular, it follows by Corollary 2.5 that if B^- or B^+ is not a strong deformation retract of B then its invariant part

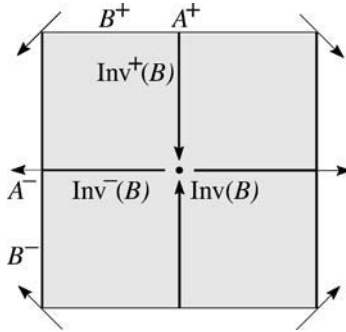

Fig. 6.

$Inv(B)$ is nonempty. Our aim is to provide a more accurate information on its properties that it was given for $W \setminus W^*$ in Section 6. For this reason we introduce some other concepts related to B . Denote by $A(B)$ (or shortly A , if it does not lead to confusions) the subset of B given by

$$A := A(B) := Inv^-(B) \cup Inv^+(B).$$

It follows, in particular, that its exit and entrance sets are given as

$$A^\pm = A \cap B^\pm.$$

Below we frequently use abbreviated notation for the invariant part of the isolating block B ; we put:

$$I := Inv(B).$$

The position of the mentioned sets in the block B can be seen on Figure 6.

Let B be an isolating block (with respect to the flow ϕ).

DEFINITION 7.2. A set $Z \subset B$ is called *B-invariant* if for every $x \in Z$ the connected component of $\phi(x) \cap B$ containing x is a subset of Z .

The connected component which appears in the above definition is equal to $\phi(x, \Delta)$, where Δ is the closed interval having $\sigma^-(x)$ and $\sigma^+(x)$ as the ends. In particular, it is equal to $\phi(x)$ if $x \in I$. The sets A and $Inv^\pm(B)$ are examples of B -invariant sets.

For $n \in \mathbb{N}$ define

$$A_n := \{x \in A : \sigma^-(x) \geq n, \sigma^+(x) \geq n\},$$

$$B_n := \{x \in B : \sigma^-(x) + \sigma^+(x) \geq n\} \supset A.$$

In particular, B_n is B -invariant, $A_0 = A$, $B_0 = B$, and $B_n^\pm = B^\pm \cap B_n$. We list some properties of those sets:

LEMMA 7.1.

- (i) B_n is a neighborhood of A in B and for every neighborhood U of A there exists n such that $B_n \subset U$.
- (ii) For every n there exists a compact set $D_n \subset B$,

$$B_{n+1} \cup B^- \subset D_n \subset B_n \cup B^-$$

such that D_n is a strong deformation retract of $Z \cup B^-$ for every B -invariant set Z such that $B_n \subset Z$. In particular, D_n is a strong deformation retract of B as well as of $B_n \cup B^-$.

- (iii) For every neighborhood V of I there exists n such that $A_n \subset V$.
- (iv) A_{n+1} is a strong deformation retract of A_n for every n .
- (v) $\text{Inv}^\pm(B) \cap A_{n+1}$ is a strong deformation retract of $\text{Inv}^\pm(B) \cap A_n$ for every n .

PROOF. In the proof we frequently refer to the continuity of σ^\pm (see Proposition 7.1).

Ad (i) and (iii). They immediately follow by that continuity.

Ad (ii). Let $f : B^- \rightarrow [0, 1]$ be a continuous function such that $f(x) = 0$ if $\sigma^-(x) \leq n$ and $f(x) = 1$ if $\sigma^-(x) \geq n + 1$. Define $g : B^- \rightarrow [0, n + 1]$ by

$$g(x) = \begin{cases} f(x)\sigma^-(x), & \text{if } \sigma^-(x) \leq n + 1, \\ n + 1, & \text{if } \sigma^-(x) \geq n + 1. \end{cases}$$

In particular, $g(x) \leq \sigma^-(x)$ for $x \in B^-$. The set

$$D_n := B_{n+1} \cup \{\phi(x, -t) \in B : x \in B^-, t \leq g(x)\}$$

has the required properties. Indeed, the map r defined by

$$r(x) := \begin{cases} \phi(x, \sigma^+(x)), & \text{if } \sigma^-(x) + \sigma^+(x) \leq n, \\ \phi(x, \sigma^+(x) - g(\phi(x, \sigma^+(x))))), & \text{if } n \leq \sigma^-(x) + \sigma^+(x) \leq n + 1 \\ & \text{and } g(\phi(x, \sigma^+(x))) \leq \sigma^+(x), \\ x, & \text{if } n \leq \sigma^-(x) + \sigma^+(x) \leq n + 1 \\ & \text{and } g(\phi(x, \sigma^+(x))) \geq \sigma^+(x) \\ & \text{or if } x \in B_{n+1} \end{cases}$$

is a strong deformation retraction $B \rightarrow D_n$ and each its restriction to $Z \cup B^- \rightarrow D_n$ is a strong deformation retraction as well.

Ad (iv) and (v). The map $s : A_n \rightarrow A_{n+1}$,

$$s(x) := \begin{cases} \phi(x, n + 1 - \sigma^-(x)), & \text{if } \sigma^-(x) \leq n + 1, \\ \phi(x, \sigma^+(x) - n - 1), & \text{if } \sigma^+(x) \leq n + 1, \\ x, & \text{otherwise} \end{cases}$$

is a strong deformation retraction required in (iv); its restrictions apply to (v). □

As a consequence we get the following estimate on the category of I :

THEOREM 7.1 (compare Theorem 3.1 in [63]). *If B and B^- are ANRs then*

$$\text{cat}(I) \geq \text{cat}(B, B^-).$$

PROOF. Lemma 7.1(iii) implies

$$I = \bigcap_{n \in \mathbb{N}} A_n \cap \text{Inv}^+(B),$$

hence the result follows by Proposition 5.1(iv), Corollary 6.1, and Lemma 7.1(v). □

7.2. Estimates on the cohomology of the invariant part

We begin with the case B^- or B^+ empty. It follows I is an *attractor* (or, in other terminology, an *asymptotically stable set*) for the flow ϕ or, respectively, its reverse. In that case we have a satisfactory information on the topology of I given by the following result:

THEOREM 7.2. *If $B^- = \emptyset$ or $B^+ = \emptyset$ then the inclusion $I \hookrightarrow B$ induces an isomorphism $\check{H}^*(B) \rightarrow \check{H}^*(I)$.*

PROOF. Assume that $B^- = \emptyset$ (for a proof in the other case it suffices to reverse the direction of time). For every $t \geq 0$ the inclusion $\phi_t(B) \hookrightarrow B$ induces an isomorphism in the cohomologies,

$$\bigcap_{t \geq 0} \phi_t(B) = I,$$

hence the result is an immediate consequence of the continuity property of the Čech cohomologies (compare [71]). □

REMARK 7.1. Actually, it is not difficult to prove a stronger result: $I \hookrightarrow B$ is a *shape equivalence* (compare [38]; more information on the notion of shape can be found in [15]). In [38], there is an example in which B is an annular region of the plane and I is the *Warsaw circle*, hence, in general, the shape equivalence cannot be further improved to the homotopy equivalence.

On the other hand, if neither B^- nor B^+ is empty, usually one cannot get enough information from B to determine the topology of I , as it is indicated on the following example:

EXAMPLE 7.1. Let ϕ be a local flow generated by a vector-field v in \mathbb{R}^n . Assume that B is an isolating block for ϕ and there exists an $x_0 \in \text{int } B$ such that $0 < \sigma^\pm(x_0) < \infty$. In particular, $x_0 \notin I$, hence $v(x_0) \neq 0$. Let D be an $(n - 1)$ -dimensional disc centered at

x_0 and contained in the affine hyperplane perpendicular to $v(x_0)$ such that v is transversal to D . By the continuity of σ^\pm , we can assume that

$$0 < \sigma^\pm(y) < \infty, \quad \text{for every } y \in D. \tag{7.1}$$

Let K be an arbitrary compact set contained in D and let $g : \mathbb{R}^n \rightarrow [0, \infty)$ be a continuous function such that

$$K = \{x \in \mathbb{R}^n : g(x) = 0\}.$$

It follows by (7.1) that B is an isolating block for the local flow generated by

$$\dot{x} = g(x)v(x),$$

its invariant part is equal to $I \cup K$, and $I \cap K = \emptyset$. The latter implies that $\check{H}^*(K)$ is a direct factor of $\check{H}^*(I \cup K)$. Except of some limitations which we do not precise here, $\check{H}^q(K)$ is an arbitrary countably generated Abelian group if $0 \leq q \leq n - 2$ and is equal to zero if $q \geq n - 1$ since K is homeomorphic to a subset of \mathbb{R}^{n-1} , hence $\check{H}^q(I \cup K)$ is at least as complicated.

From the above example we conclude that the Čech cohomology of the invariant part of B can be almost arbitrarily complex. Thus, in general one can at most expect to estimate the “lower bound” of the cohomology of I . We provide several results in this direction. A majority of them can be duplicated by substituting B^+ instead of B^- , etc.

Our first aim is to present an exact sequence which connects the cohomologies of I , (B, B^-) , and A^- due to Churchill in [18].

PROPOSITION 7.2 (compare Lemma 4.3 in [18]). *The inclusion $(A, A^-) \hookrightarrow (B, B^-)$ induces an isomorphism $H^*(B, B^-) \rightarrow \check{H}^*(A, A^-)$.*

PROOF. By Lemma 7.1, the homotopy and excision properties of the cohomology imply that the inclusions induce a sequence of isomorphisms

$$\check{H}^*(B, B^-) \cong \check{H}^*(D_n, B^-) \cong H^*(B_n \cup B^-, B^-) \cong H^*(B_n, B_n^-)$$

for every n . It follows that the inclusion $(B_{n+1}, B_{n+1}^-) \hookrightarrow (B_n, B_n^-)$ induces an isomorphism, hence there is also an isomorphism

$$\check{H}^*(B, B^-) \cong \text{dir lim } \check{H}^*(B_n, B_n^-)$$

induced by the inclusions. Since

$$\bigcap_{n \in \mathbb{N}} (B_n, B_n^-) = (A, A^-),$$

the result follows by the continuity of the Čech cohomology. □

PROPOSITION 7.3 (compare Proposition 4.6 in [18]). *The inclusion $I \hookrightarrow A$ induces an isomorphism $\check{H}^*(A) \rightarrow \check{H}^*(I)$.*

PROOF. It follows by Lemma 7.1 that the inclusion $A_{n+1} \hookrightarrow A_n$ induces an isomorphism in cohomologies and

$$\bigcap_{n \in \mathbb{N}} A_n = I,$$

hence the result follows by the properties of homotopy and continuity of the Čech cohomology. □

THEOREM 7.3 (compare Theorem 4.7 in [18]). *There exists an exact sequence*

$$\dots \xrightarrow{\delta^{q-1}} \check{H}^q(B, B^-) \xrightarrow{\beta^q} \check{H}^q(I) \xrightarrow{\gamma^q} \check{H}^q(A^-) \xrightarrow{\delta^q} \check{H}^{q+1}(B, B^-) \xrightarrow{\beta^{q+1}} \dots$$

in which β^q is induced by the inclusion for every $q \in \mathbb{Z}$.

PROOF. By Propositions 7.2 and 7.3, it suffices to substitute $\check{H}^q(A, A^-) \rightarrow \check{H}^q(A)$ by β^q in the exact sequence of the pair (A, A^-) . □

The above result is not completely satisfactory since the term $\check{H}^*(A^-)$ in the exact sequence cannot be determined from B and B^- alone. Nevertheless, some estimates can be obtained by its application. In the following corollary and example, χ and $\check{\chi}$ denote the Euler characteristic with respect to singular cohomologies and, respectively, Čech cohomologies. A standard fact from homological algebra on exact sequences and the corresponding Euler characteristics leads to the following

COROLLARY 7.1. *If two Euler characteristics among $\check{\chi}(I)$, $\check{\chi}(B, B^-)$, and $\check{\chi}(A^-)$ are defined, then the third one is also defined and*

$$\check{\chi}(I) = \check{\chi}(B, B^-) + \check{\chi}(A^-).$$

EXAMPLE 7.2. Let a 2-dimensional manifold be the phase space of the considered local flow. Assume that an isolating block B is a manifold with boundary and B^- is a submanifold with boundary of ∂B (for example, given as a generalized polyfacial set like in Remark 3.2). In that case B and B^- are compact ENRs, hence the Čech cohomologies of (B, B^-) are isomorphic to the corresponding singular cohomologies. Moreover, $\check{H}^q(B, B^-)$ is finite-dimensional for every q and equal to zero if $q \geq 3$ and B^- is the union of components each of which is homeomorphic to the circle S^1 or to the interval $[0, 1]$. Thus the set A^- consists of the union of some number of the components of B^- homeomorphic to the circle and a set K homeomorphic to a compact subset of \mathbb{R} . If K has infinitely many components then from the exact sequence in Theorem 7.3 we conclude that $\check{H}^0(I)$ is infinitely generated (hence I has infinitely many components) because

$\text{Im } \gamma^0 = \ker \delta^0$ and $\ker \delta^0$ is infinite-dimensional since $\dim \check{H}^1(B, B^-) < \infty$. In the opposite case, the subset K consists of a finite number of isolated points and sets homeomorphic to $[0, 1]$. Since the Euler characteristic of the circle is equal to zero,

$$\check{\chi}(A^-) = \dim \check{H}^0(K) \geq 0.$$

In particular, as a consequence of Corollary 7.1 we get

$$\check{\chi}(I) \geq \chi(B, B^-). \tag{7.2}$$

Denote by 1 the unit element in the ring of coefficients R of the Čech cohomology. The following notation will also be used: if $(Y, Y') \subset (X, X')$ and $u \in \check{H}^*(X, X')$ then $u|_{(Y, Y')}$ denotes the image of u under the homomorphism induced by the inclusion $(Y, Y') \hookrightarrow (X, X')$. The next theorem is an equivalent version of a result of Floer (compare [30, Proposition 2]—it is written there that another version of that result was stated by Benci in an unpublished report). The proof given here is taken from [77].

THEOREM 7.4. *If for $u \in \check{H}^*(B)$ there exists $v \in \check{H}^*(B, B^-)$ such that $u \smile v \neq 0$ then $u|_I \neq 0$ in $\check{H}^*(I)$.*

PROOF. In the commutative diagram

$$\begin{array}{ccc} \check{H}^*(B) \otimes \check{H}^*(B, B^-) & \xrightarrow{\smile} & \check{H}^*(B, B^-) \\ \downarrow & & \downarrow \cong \\ \check{H}^*(A) \otimes \check{H}^*(A, A^-) & \xrightarrow{\smile} & \check{H}^*(A, A^-) \end{array}$$

the vertical arrows are generated by the inclusions and those induced by $(A, A^-) \hookrightarrow (B, B^-)$ is an isomorphism by Proposition 7.2, hence

$$u|_A \smile v|_{(A, A^-)} = (u \smile v)|_{(A, A^-)} \neq 0.$$

Thus $u|_A \neq 0$. Since $I \hookrightarrow A$ induces an isomorphism by Proposition 7.3,

$$u|_I = (u|_A)|_I \neq 0,$$

hence the result follows. □

By Theorem 7.4, if $v \in \check{H}^*(B, B^-)$ is nonzero then $1 \smile v = v \neq 0$ (where 1 is treated as the element of $\check{H}^0(B)$), hence $1|_I \neq 0$, which means $I \neq \emptyset$. Thus, in the case of isolating block, Theorem 7.4 is a generalization of a weaker variant of Corollary 2.5, in which the condition $\check{H}^*(B, B^-) \neq 0$ replaces the condition B^- is not a strong deformation retract of B .

In the following simple example we explain the meaning of Theorem 7.4.

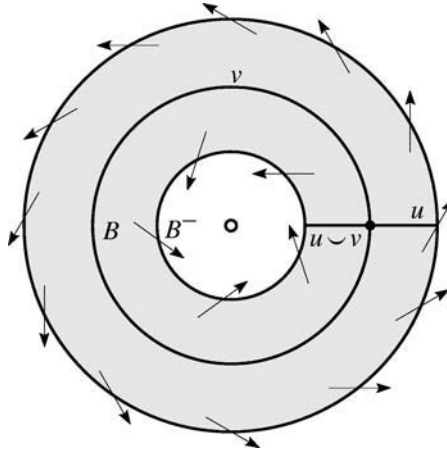

Fig. 7.

EXAMPLE 7.3. Consider the flow on the punctured plane $\mathbb{R}^n \setminus 0$ such the annulus

$$B = \{(r, \theta): 1 \leq r \leq 2\}$$

(written in the polar coordinates) is an isolating block for the flow and its exit set B^- is equal the boundary of B , see Figure 7. Assume for simplicity that $R = \mathbb{Z}_2$, hence there is one generator u of $\check{H}^1(B)$ and one generator v of $\check{H}^1(B, B^-)$. On the figure, they are represented by their supports: u as the vertical segment and v as the circle inside B . Their cup-product $u \smile v$, represented as the intersection of the supports of u and v , is the generator of $\check{H}^2(B, B^-)$. It follows, by Theorem 7.4 that $u|_{\text{Inv}(B)} \neq 0$.

Actually, in that particular example (which was chosen because of its visualization on the plane) the same conclusion is given by Theorem 7.2. This is not the case in the next example which is a direct generalization of the above one.

EXAMPLE 7.4. Now we use different letters to denote the sets considered in the previous example: put

$$G := \{(r, \theta) \in \mathbb{R}^2: 1 \leq r \leq 2\},$$

$$H := \{(r, \theta) \in \mathbb{R}^2: r \in \{1, 2\}\}.$$

As usual, D^q and S^{q-1} denote the unit ball and, respectively, the unit sphere centered at zero in \mathbb{R}^q . Consider a local flow in the phase space

$$X = (\mathbb{R}^2 \setminus 0) \times \mathbb{R}^{m+n}$$

and assume that the isolating block and its exit set are given by

$$B := G \times D^m \times D^n, \\ B^- := H \times D^m \times D^n \cup G \times S^{m-1} \times D^n.$$

We assume again that $R = \mathbb{Z}_2$ and let $u \in \check{H}^1(G)$, $v \in \check{H}^1(G, H)$, and $z \in \check{H}^m(D^m \times D^n, S^{m-1} \times D^n)$ be the generators. It follows that

$$(u \times 1) \smile (v \times z) = (u \smile v) \times z \neq 0,$$

where \times denotes the cohomological cross-product (compare [28]) and $1 \in \check{H}^0(D^m \times D^n)$ is the unit element, hence Theorem 7.4 implies

$$(u \times 1)|_I \neq 0.$$

From that conclusion we can get slightly more information than just $\check{H}^1(I) \neq 0$. Let

$$\pi : G \times D^m \times D^n \rightarrow G$$

be the projection. For an arbitrarily chosen $\theta_0 \in [0, 2\pi)$ put

$$R := \{(r, \theta) \in G : \theta = \theta_0\}.$$

We assert that

$$\pi(I) \cap R \neq \emptyset.$$

Indeed, since $\check{H}^1(\pi)(u) = u \times 1$,

$$u|_{\pi(I)} \neq 0.$$

Since the inclusion $G \hookrightarrow (G, G \setminus R)$ induces an isomorphism in \check{H}^1 , there exists $w \in \check{H}^1(G, G \setminus R)$ such that $u = w|_G$. It follows that

$$w|_{(\pi(I), \pi(I) \setminus R)} \neq 0,$$

hence $\pi(I) \setminus R \not\subseteq \pi(I)$ which verifies the assertion.

The conclusions in the above example do not follow from Theorem 7.2 if $n \geq 1$. It should also be noted that the usage of the Čech cohomologies is essential; in general the above results are non valid for the singular cohomologies by the example mentioned in Remark 7.1. In the paper [30], the version of Theorem 7.4 was formulated using the notion of cup-length. The following immediate consequence of Theorem 7.4 estimates the cup-length of the invariant part of an isolating block.

COROLLARY 7.2. $\ell(I) \geq \ell(B, B^-)$.

7.3. On the number of stationary points of gradient-like flows

Let $g : X \rightarrow \mathbb{R}$ be a Liapunov function for a local flow ϕ on X . For $a \in \mathbb{R}$ we write

$$g_a := g^{-1}(a).$$

DEFINITION 7.3. The set g_a is called a *level of g* . It is called a *critical level* if it contains a stationary point; in this case a is called a *critical value*. In the other case it is called *noncritical*.

For $a < b$ put

$$g_a^b := g^{-1}([a, b]).$$

Now we recall the most fundamental result concerning the notion of category. Usually, it is stated for gradient flows. Here we provide its topological version.

PROPOSITION 7.4. *Let g be a Liapunov function on X . If g_a^b is a compact ANR, g_a and g_b are noncritical levels then*

$$\#\{x \in X: x \text{ stationary, } a < g(x) < b\} \geq \text{cat}(g_a^b, g_a).$$

PROOF. Put $k =: \text{cat}(g_a^b, g_a)$. First of all observe that $k \leq \infty$ since the category of a compact ANR is finite (which is easy to prove; see [16]) and (5.2) holds. We can assume that the number of stationary points is finite and $k \geq 1$; otherwise there is nothing to prove. Thus there is a finite number of critical levels between a and b . We adapt the standard mini-max argument. For $i = 1, \dots, k$ define

$$\begin{aligned} \mathcal{C}_i &:= \{C \subset g_a^b: C \text{ compact, } \text{cat}_{g_a^b, g_a}(C) \geq i\}, \\ c_i &:= \inf_{C \in \mathcal{C}_i} \max_{x \in C} g(x). \end{aligned}$$

We claim that c_i is a critical value. Indeed, in the other case there exists an $\varepsilon > 0$ such that $a < c_i - \varepsilon < c_i + \varepsilon < b$ and there are no critical values in the interval $[c_i - \varepsilon, c_i + \varepsilon]$ since the set of critical values is finite. It follows that $g_{c_i - \varepsilon}^{c_i + \varepsilon}$ is an isolating block and $g_{c_i - \varepsilon}$ is its exit set. Since that set has the invariant part empty by Remark 6.1, there is a strong deformation retraction $r : g_{c_i - \varepsilon}^{c_i + \varepsilon} \rightarrow g_{c_i - \varepsilon}$. It follows that if $C \in \mathcal{C}_i$ and $\max_{x \in C} g(x) < c_i + \varepsilon$ then $r(C) \in \mathcal{C}_i$ and

$$\max_{x \in r(C)} g(x) = c_i - \varepsilon$$

which is a contradiction. The critical values c_i are ordered

$$a < c_1 \leq \dots \leq c_k < b$$

since $\mathcal{C}_j \subset \mathcal{C}_i$ if $i < j$. Denote by K_{c_i} the set of stationary points contained in g_{c_i} . It suffices to prove that if $c_i = c_{i+q}$ then

$$\text{cat}_{g_a^b}(K_{c_i}) = q + 1,$$

since in that case K_{c_i} contain at least $q + 1$ different points.

Let $\varepsilon > 0$ be such that $a < c_i - \varepsilon < c_i + \varepsilon < b$ and $c_i = c_{i+q}$ is the only critical value in $[c_i - \varepsilon, c_i + \varepsilon]$. Since there exists $C \in \mathcal{C}_{i+q}$ such that $C \subset g_a^{c_i+\varepsilon}$, by Proposition 5.1(i),

$$\text{cat}_{g_a^b, g_a}(g_a^{c_i+\varepsilon}) \geq i + q. \tag{7.3}$$

It follows also by the choice of c_i that

$$\text{cat}_{g_a^b, g_a}(g_a^{c_i-\varepsilon}) \leq i - 1. \tag{7.4}$$

Denote $B := g_{c_i-\varepsilon}^{c_i+\varepsilon}$. It is an isolating block, $B^- = g_{c_i-\varepsilon}$ and $\text{Inv}(B) = K_{c_i}$ by Remark 6.1. We can apply Proposition 5.1(iv) since g_a is an ANR. Indeed, let $\delta > 0$ be such that there are no critical points in $[a, a + \delta]$. It follows that g_a is a strong deformation retract of $\{x: a \leq g(x) < a + \delta\}$. The latter set is open in g_a^b , hence it is an ANR by Theorem of Hanner (compare [13]) and g_a is an ANR as well. Thus, by Lemma 7.1 and by Proposition 5.1(iii) and (iv), for n and m sufficiently large we have the following sequence of equations:

$$\text{cat}_{g_a^b}(K_{c_i}) = \text{cat}_{g_a^b}(A_m) = \text{cat}_{g_a^b}(A) = \text{cat}_{g_a^b}(B_n).$$

Thus, again by Lemma 7.1 and Proposition 5.1,

$$\begin{aligned} i + q &\leq \text{cat}_{g_a^b, g_a}(g_a^{c_i+\varepsilon}) = \text{cat}_{g_a^b, g_a}(g_a^{c_i-\varepsilon} \cup D_n) \leq \text{cat}_{g_a^b, g_a}(g_a^{c_i-\varepsilon}) + \text{cat}_{g_a^b}(B_n) \\ &\leq i - 1 + \text{cat}_{g_a^b}(K_{c_i}), \end{aligned}$$

which finishes the proof. □

THEOREM 7.5. *If ϕ is gradient-like and B and B^- are ANR-s then*

$$\#\{x \in I: x \text{ stationary}\} \geq \text{cat}(B, B^-).$$

PROOF. Let $g : X \rightarrow \mathbb{R}$ be a Liapunov function. In the topological direct sum

$$B \sqcup (B^- \times (-\infty, 0]) \sqcup (B^+ \times [0, \infty))$$

identify each element of $B^- \subset B$ with an element of $B^- \times (-\infty, 0]$ via the map $j^- : z \rightarrow (z, 0)$ and, similarly, each element of $B^+ \subset B$ with an element of $B^+ \times [0, \infty)$ via the map $j^+ : z \mapsto (z, 0)$. Denote the obtained adjunction by \tilde{B} , i.e.,

$$\tilde{B} := B \cup_{j^-} (B^- \times (-\infty, 0]) \cup_{j^+} (B^+ \times [0, \infty)).$$

In a natural way we define a flow $\psi : \tilde{B} \times \mathbb{R} \rightarrow \tilde{B}$ as an extension of ϕ restricted to B . If $z \in B$ put

$$\psi(z, t) := \begin{cases} \phi(z, t) \in B, & \text{if } -\sigma^-(x) \leq t \leq \sigma^+(x), \\ (\phi(x, \sigma^+(x)), \sigma^+(x) - t) \in B^- \times (-\infty, 0], & \text{if } t \geq \sigma^+(x), \\ (\phi(x, -\sigma^-(x)), \sigma^-(x) - t) \in B^+ \times [0, \infty), & \text{if } t \leq -\sigma^-(x), \end{cases}$$

if $(x, \tau) \in B^- \times (-\infty, 0]$ put

$$\psi((x, \tau), t) := \begin{cases} (x, \tau - t), & \text{if } t \geq \tau, \\ \psi(x, t - \tau), & \text{if } t \leq \tau, \end{cases}$$

and similarly, if $(x, \tau) \in B^+ \times [0, \infty)$ put

$$\psi((x, \tau), t) := \begin{cases} \psi(x, t - \tau), & \text{if } t \geq \tau, \\ (x, \tau - t), & \text{if } t \leq \tau. \end{cases}$$

Define also a function $G : \tilde{B} \rightarrow \mathbb{R}$,

$$G(z, t) := \begin{cases} g(z), & \text{if } z \in B, \\ g(x) + \tau, & \text{if } z = (x, \tau) \in B^- \times (-\infty, 0] \text{ or } B^+ \times [0, \infty). \end{cases}$$

G is a Liapunov function for ψ and the stationary points of ϕ restricted to B and ψ coincide. Let $a < b$ be such that

$$a < \min g(B) \leq \max g(B) < b$$

It follows that a and b are noncritical values of G . Put

$$M := \{(x, \tau) \in B^- \times (-\infty, 0], \tau \geq b - g(x)\},$$

$$N := \{(x, \tau) \in B^+ \times [0, \infty), \tau \leq a - g(x)\},$$

hence

$$G_a^b = B \cup M \cup N$$

and G_a^b is a compact ANR since M and N are compact ANRs as retracts of ANRs $B^- \times (-\infty, 0]$ and $B^+ \times [0, \infty)$ and the intersections of B with M and N coincide with B^- and B^+ , respectively. Using the definition of the relative category it is easy to prove that

$$\text{cat}(G_a^b, G_a) = \text{cat}(B, B^-).$$

The result is a consequence of Proposition 7.4. □

EXAMPLE 7.5. The following fact was essential in the proof of an Arnold’s conjecture by Conley and Zehnder (compare [23]): if

$$B = T^q \times D^m \times D^n,$$

is an isolating block for a gradient-like flow, where T^q is the q -dimensional torus, and

$$B^- = T^q \times S^{m-1} \times D^n$$

then there are at least $q + 1$ stationary points contained in B . Indeed, in this case

$$\ell(B, B^-) = q + 1$$

hence the result follows by Proposition 5.4 and Theorem 7.5.

REMARK 7.2. Results on the existence and the number of critical points of functionals are essential in variational methods. Since the spaces considered in those methods are infinite-dimensional, usually direct applications of results based on algebraic topology fail there. For some functionals it is possible, however, to pass to a finite dimension by the saddle-point reduction due to Amann and Zehnder (compare [2]). In particular, it was applied in the paper [23] to reduce the initial problem to calculation of the number of critical points inside the isolating block mentioned in Example 7.5.

7.4. Fixed point index and the index of stationary points

Using Theorem 6.2 one can check whether the set of stationary points inside of an isolating block is nonempty. Below we provide quantitative information on properties of that set using the notion of fixed point index.

Assume that X is a ENR, ϕ is a local flow on X , and B is an isolating block.

LEMMA 7.2. For every $T > 0$,

$$I_T := \{x \in I: \phi_T(x) = x\}$$

is an isolated set of fixed points of ϕ_T .

Let U be an open subset of X such that \overline{U} is compact and there are no stationary points of ϕ in ∂U . It follows that there is an $\varepsilon > 0$ such that the set

$$K_t(U) := \{x \in U: \phi_t(x) = x\}$$

is an isolated set of fixed points of ϕ_t for every t such that $0 < t < \varepsilon$. By Proposition 5.7(iv), the indexes of $K_s(U)$ and $K_t(U)$ coincide if s and t are nonzero and small, hence we can define an integer number

$$i(\phi, U) := \lim_{0 < t \rightarrow 0} \text{ind}(\phi_t, K_t(U)).$$

We call the number $i(\phi, U)$ the *index of stationary points of ϕ in U* (compare [72, Section 4]). It inherits properties of the fixed point index. It can be proved that if $X = \mathbb{R}^n$ and ϕ is generated by a C^1 -class vector-field v then

$$i(\phi, U) = (-1)^n \text{deg}(0, v, U),$$

where deg denotes the Brouwer degree.

THEOREM 7.6 (compare Theorem 4.4 in [72]). *If B is an isolating block on X and B and B^- are ENRs, and $T > 0$ then*

$$\text{ind}(\phi_T, I_T) = \chi(B, B^-),$$

$$i(\phi, \text{int } B) = \chi(B, B^-).$$

PROOF. The second equation is a consequence of the first one and the definition of the index. Since the first equation is a particular case of the more general equation in Theorem 7.7 below, we do not provide its rigorous proof here. We mention only that it can be proved by a careful examination of Step 1 in the proof of Theorem 6.2. Indeed, the corresponding indexes of ϕ_T in B and ψ_T at I_T coincide by Proposition 5.7(v) and the index of fixed points of ψ_T is equal to $\chi(\tilde{B})$ by (vi) in that proposition. By those facts it is easy to conclude the required property; for a detailed argument we refer to the proof of Theorem 7.7 (or to [72]). □

It should be pointed out that all proper T -periodic points do not contribute to $\text{ind}(\phi_T, I_T)$ since both indexes are equal to the same number $\chi(B, B^-)$. In the case of a local flow generated by a smooth vector-field on a Riemannian manifold, B being a manifold with boundary and B^- its submanifold (like in Remark 3.2) the above result is a particular case of the formula of Pugh generalizing the Poincaré index formula (compare [34,64]).

EXAMPLE 7.6. The index of stationary points contained in the isolating block in Figure 1 or Figure 6 is equal to -1 , while in the isolating block in Figure 7 it is equal to 0.

EXAMPLE 7.7. As in Example 7.2, we assume that X is a 2-dimensional manifold, the isolating block B is a manifold with boundary, and B^- is a submanifold with boundary of ∂B . Assume that the invariant part I of B consists only of a single stationary point. It follows by (7.2) and Theorem 7.6 that

$$i(\phi, \text{int } B) \leq 1.$$

7.5. Isolating segments

It is convenient to use special kinds of isolating blocks if the considered local semiflow is generated by a nonautonomous equation in its extended phase space. As in Section 3.1, let

M be a smooth Riemannian manifold, U open subset of $\mathbb{R} \times M$, and let $w : U \rightarrow TM$ be a continuous mapping such that $w(t, x) \in T_x M$. We assume that the system (3.9) satisfies the uniqueness property of the Cauchy problem and let ϕ be the induced local flow on U . It follows that ϕ is of a special form: there is a map $\Phi : (\sigma, \tau, x) \mapsto \Phi_{\sigma, \tau}(x)$, called the *evolutionary operator for (3.8)*, such that

$$\phi_t(\sigma, x) = (\sigma + t, \Phi_{\sigma, \sigma+t}(x))$$

for $(\sigma, x) \in U$. In particular,

$$\Phi_{s,s} = \text{id}, \quad \Phi_{s,u} = \Phi_{t,u} \circ \Phi_{s,t}.$$

Actually, basing on that properties, the evolutionary operator can be defined in a purely topological way and the results presented below are valid in that more general setting; here we do not develop that approach.

At first we fix the notation concerning the extended phase space. For a subset Z of $\mathbb{R} \times M$ we put

$$Z_t := \{x \in M : (t, x) \in Z\}$$

and by π_1 and π_2 we denote the projections $\mathbb{R} \times M \rightarrow \mathbb{R}$ and, respectively, $\mathbb{R} \times M \rightarrow M$. Let a and b be real numbers, $a < b$.

DEFINITION 7.4. A compact set $W \subset U$ is called an *isolating segment over $[a, b]$* for (3.8) if the exit and entrance sets W^\pm with respect to the local flow ϕ are also compact and

$$\partial W = W^+ \cup W^-$$

(hence W is an isolating block for ϕ), there exist compact subsets W^{--} and W^{++} of ∂W (called, respectively, the *proper exit set* and the *proper entrance set*) such that

$$W^- = (\{b\} \times W_b) \cup W^{--}, \quad W^+ = (\{a\} \times W_a) \cup W^{++},$$

and there exists a homeomorphism

$$h : [a, b] \times W_a \rightarrow W$$

satisfying $\pi_1 \circ h = \pi_1$ such that

$$h([a, b] \times W_a^{--}) = W^{--}, \quad h([a, b] \times W_a^{++}) = W^{++}.$$

It follows, in particular, that if B is an isolating block for an autonomous equation (1.1) satisfying $\partial B = B^+ \cup B^-$ then for every a and b the set $W = [a, b] \times B$ is an isolating segment and

$$W^{--} = [a, b] \times B^-, \quad W^{++} = [a, b] \times B^+.$$

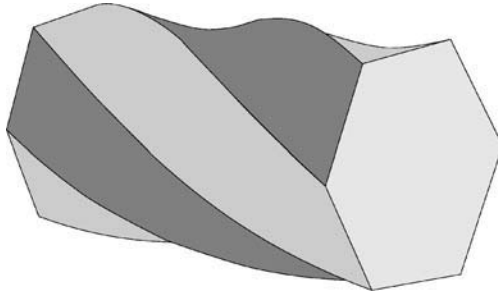

Fig. 8.

A more complicated example of an isolating segment is drawn in Figure 8. Here W is equal to the twisted prism with hexagonal base and each of the sets W^{--} and W^{++} consists of three disjoint ribbons winding around the prism.

Isolating segments are useful in proofs of results concerning the existence of solutions of two-point boundary value problems, as we show below in the case of the periodic problem. In [78], a more general notion of *isolating chain* was considered. (By definition, it is an isolating block being the union of contiguous isolating segments in the extended phase space of a nonautonomous equation.)

Let W be an isolating segment over $[a, b]$. A homeomorphism h in Definition 7.4 induces a homeomorphism

$$m : (W_a, W_a^{--}) \rightarrow (W_b, W_b^{--}), \quad m(x) := \pi_2 h(b, \pi_2 h^{-1}(a, x)).$$

We call m a *monodromy homeomorphism* of the isolating segment W . It depends on h , however one can prove the monodromy homeomorphisms determined by different choices of h are homotopic each to the other. It follows that the isomorphism in homologies

$$\mu_W := H(m) : H(W_a, W_a^{--}) \rightarrow H(W_b, W_b^{--})$$

is an invariant of W .

DEFINITION 7.5. An isolating segment W over $[a, b]$ is called *periodic* if $W_a = W_b$, $W_a^{--} = W_b^{--}$, and $W_a^{++} = W_b^{++}$.

The segment shown in Figure 8 is periodic. If W is periodic then μ_W is an automorphism of $H(W_a, W_a^{--})$. Let H has coefficients in \mathbb{Q} . If, moreover, both W_a and W_a^{--} are ANRs then the Lefschetz number $\Lambda(m)$ is defined and independent of the choice of the monodromy homeomorphism. Thus we can define

$$\Lambda_W := \Lambda(m).$$

THEOREM 7.7 (compare Theorem 7.1 in [74]). *Let W be a periodic isolating segment over $[a, b]$. Then the set*

$$K_W := \{x \in W_a : \Phi_{a,b}(x) = x, \Phi_{a,t}(x) \in W_t \forall t \in [a, b]\}$$

is an isolated set of fixed points of $\Phi_{a,b}$ and if W , W^{--} , and W^{++} are ENRs then

$$\text{ind}(\Phi_{a,b}, K_W) = \Lambda_W.$$

PROOF. Observe first that $\partial W_a = W_a^{--} \cup W_a^{++}$. Indeed, by the open mapping theorem, $h^{-1}(\text{int } W)$ is open in $\mathbb{R} \times M$. Since $\partial W = W^- \cup W^+$,

$$h^{-1}(\text{int } W) = (a, b) \times (W_a \setminus (W_a^{--} \cup W_a^{++})).$$

Thus the image of $h^{-1}(\text{int } W)$ under the projection π_2 onto M is equal to $W_a \setminus (W_a^{--} \cup W_a^{++})$ and is also open, hence it is equal to the interior of W_a and the assertion follows. Since K_W does not intersect ∂W_a , it is open and compact in the set of fixed points of $\Phi_{a,b}$, hence it is isolated.

For a proof of the rest of the conclusion we define a map $m_t : W_t \rightarrow W_a$, where $a \leq t \leq b$, by

$$m_t(x) := \pi_2 h(b, \pi_2 h^{-1}(t, x))$$

(recall that we assume $W_a = W_b$). In particular, $m_a = m$ and $m_b = \text{id}$. Moreover, for $x \in W_a$ put

$$\tau(z) := a + \sigma^+(a, z) \leq b,$$

where σ^+ is the escape-time function for W (with respect to ϕ). We use a similar adjunction as in the proof of Theorem 6.2:

$$Z := W_a \cup_j (W_a^{--} \times S^1),$$

where $j : x \mapsto (x, 1)$ for $x \in W_a^{--}$ (i.e., in the disjoint union of W_a and $W_a^{--} \times S^1$ we identify W_a^{--} with $W_a^{--} \times \{1\}$). By assumptions, Z is an ENR. Define a map $\Psi : Z \times [a, b] \rightarrow Z$ by

$$\Psi(z, t) := \begin{cases} m_t(\Phi_{a,t}(z)), & \text{if } z \in W_a, \tau(z) \geq t, \\ (m_{\tau(z)}(\Phi_{a,\tau(z)}(z)), \exp\{\pi i \frac{t-\tau(z)}{b-a}\}), & \text{if } z \in W_a, \tau(z) < t, \\ (m(x), \alpha \exp\{\pi i \frac{t-a}{b-a}\}), & \text{if } z = (x, \alpha) \in W_a^{--} \times S^1. \end{cases}$$

It is easy to check that Ψ is continuous. Put $\Psi_t(z) := \Psi(z, t)$. In particular,

$$\Psi_a|_{W_a^{--} \times S^1} = m|_{W_a^{--}} \times \text{id}_{S^1},$$

hence $\Lambda(\Psi_a|_{W_a^{--} \times S^1}) = 0$. Since $\Psi_a \simeq \Psi_b$, it follows by the Mayer–Vietoris exact sequence

$$\begin{aligned} \Lambda(\Psi_b) &= \Lambda(\Psi_a) = \Lambda(\Psi_a|_{W_a}) + \Lambda(\Psi_a|_{W_a^{--} \times S^1}) - \Lambda(\Psi_a|_{W_a^{--}}) \\ &= \Lambda(m|_{W_a}) - \Lambda(m|_{W_a^{--}}) = \Lambda_W. \end{aligned}$$

It follows by the construction of Ψ that

$$\text{Fix}(\Psi_b) = K_W.$$

By the commutativity property of the fixed point index and the Lefschetz theorem (see Proposition 5.7(v) and (vi)),

$$\text{ind}(\Phi_{a,b}, K_W) = \text{ind}(\Psi_b, K_W) = \Lambda_W,$$

which terminates the proof of the theorem. □

As an immediate consequence of Proposition 5.7(i) and Theorem 7.7 we get

COROLLARY 7.3. *If W is a periodic isolating segment over $[a, b]$ and $\Lambda_W \neq 0$ then the periodic problem*

$$x(a) = x(b)$$

associated to Equation (3.8) has a solution.

Let $T > 0$ and $U = \mathbb{R} \times M$. An important special case of the theorem arises if w is T -periodic in t , i.e., if

$$w(t, x) = w(t + T, x)$$

for every $t \in \mathbb{R}$ and $x \in M$. In this case

$$\Phi_{s,t} = \Phi_{s+T,t+T}. \tag{7.5}$$

The map $\Phi_{0,T}$ is called the *Poincaré map* and its fixed points are initial points of T -periodic solutions of (3.8). In particular, if $\Lambda_W \neq 0$ then at least one T -periodic solution exists. If w does not depend on t , B is an isolating block for w and $W = [0, T] \times B$ then the first equation in Theorem 7.6 is a corollary of Theorem 7.7 as we have pointed out already. The following three examples illustrating the above results are taken from [74].

EXAMPLE 7.8. Consider a planar differential equation

$$\dot{z} = e^{2\pi it} \bar{z}^2 + f(t, z), \tag{7.6}$$

where $z \in \mathbb{C}$ and $f : \mathbb{R} \times \mathbb{C} \rightarrow \mathbb{C}$ is continuous, $f(t + 1, z) = f(t, z)$ for all t and z , and

$$\lim_{|z| \rightarrow \infty} \frac{f(t, z)}{|z|^2} = 0 \quad \text{uniformly in } t \in \mathbb{R}.$$

One can find an isolating segment W over $[0, 1]$ for (7.6) which is the twisted prism over a hexagonal base like on the Figure 8 (see [74]; actually it is a regular polyfacial set—compare Definition 3.2). Its monodromy homeomorphism m is equal to the rotation by the angle $\frac{2\pi}{3}$. Thus m is homotopic to the identity on the hexagon W_0 and alternates the three disjoint segments forming W_0^{--} , hence

$$\Lambda_W = \Lambda(m|_{W_0}) - \Lambda(m|_{W_0^{--}}) = 1 - 0 = 1.$$

By Corollary 7.3 we conclude that (7.6) has a 1-periodic point.

EXAMPLE 7.9. We consider a particular case of (7.6),

$$\dot{z} = e^{2\pi i t} \bar{z}^2 + \bar{z}. \tag{7.7}$$

Here 0 is a 1-periodic solution, hence we are looking for another one. There is another isolating segment $Z \subset W$ over $[0, 1]$ for (7.7)

$$Z := [0, 1] \times \{z \in \mathbb{C}: |\Re z| \leq \delta, |\Im z| \leq \delta\}$$

for $0 < \delta$ sufficiently small. Here Z is a prism with rectangular base and Z^{--} consists of its top and bottom sides. It is easy to observe that

$$\Lambda_Z = \chi(Z_0) - \chi(Z_0^{--}) = 1 - 2 = -1.$$

If $K_W = K_Z = \{0\}$ then

$$1 = \Lambda_W = \Lambda_Z = -1,$$

which is a contradiction, hence (7.7) has a nonzero 1-periodic solution.

EXAMPLE 7.10. We consider another equation

$$\dot{z} = e^{2\pi i t} \bar{z}^2 + z. \tag{7.8}$$

Here we try again to get a nonzero periodic solution. Now there is an isolating segment $U \subset W$,

$$U := [0, 1] \times \{z \in \mathbb{C}: |z| < \varepsilon\}$$

for $0 < \varepsilon$ small. However, it is easy to observe that

$$\Lambda_U = \chi(D^2) - \chi(S^1) = 1 - 0 = 1,$$

hence we cannot predict the existence of nonzero 1-periodic solution as it was done in the previous example. In fact, we are able to prove the existence of a 3-periodic solution. Let

$$\tilde{W} := W \cup \tau_1(W) \cup \tau_2(W),$$

where τ_T for a real number T is the translation of $\mathbb{R} \times \mathbb{C}$ given by

$$\tau_T(x, z) := (x + T, z).$$

\tilde{W} is an isolating segment over $[0, 3]$ which consists of glued three copies of W . Its monodromy homeomorphism can be obtained as the composition of three rotations by the angle $\frac{2\pi}{3}$, hence it is equal the identity and thus

$$\Lambda_{\tilde{W}} = 1 - 3 = -2.$$

Put also

$$\tilde{U} := [0, 3] \times \{z \in \mathbb{C}: |z| < \varepsilon\},$$

hence

$$\Lambda_{\tilde{W}} = -2 \neq 1 = \Lambda_{\tilde{U}}$$

and the conclusion follows.

Actually, the results given in the above examples extend to equations with Fourier–Taylor polynomials on the right-hand side, see, for example, [74]. Moreover, Theorem 7.7 can be generalized to the case of two point boundary value problems of the form

$$x(a) = g(x(b))$$

for some function $g : M \rightarrow M$ (see [76]) and to *periodic isolating chains* (see [78]).

8. Selected applications of the Ważewski method

We provide some applications of the results stated above. We begin with an application to problems concerning asymptotic properties of solutions, then we present a proof of a classical result on the existence of solutions of two-point boundary value problems for a second-order equation, and finally we state a result on the existence of a kind of chaotic dynamics.

8.1. Asymptotic solutions

The most natural applications of the Ważewski method refer to the existence of solutions remaining in a given set; for instance, theorems on bounded solutions can be provided in this way. If the considered sets in the extended phase space contract as time tends to infinity, the obtained solutions represent the corresponding asymptotic properties. There are many results of this type in the literature. In particular, theorems on solutions which tend to constant mappings are contained, for example, in [48,66,84,88] (the result in [48] is reproduced also in [65]) and results on asymptotic coincidence of solutions of two systems are, among others, in [45,53,55,56,82]. Some other asymptotic results for ordinary equations are given in [10,25,39,41,46,69,83], for retarded differential equations in [27,80], for partial differential equations of the first order in [59,60], and for the second order in [61]. For an illustration of this kind of applications of the Ważewski method, here we provide a proof of an asymptotic result for a linear equation. Let $A = (a_{ij})$ and $B = (b_{ij})$ be continuous real $(n \times n)$ -matrix-valued functions and we consider an equation

$$\dot{x} = A(t)x + B(t)x \tag{8.1}$$

in \mathbb{R}^n . We assume that $A(t)$ is diagonal for every t , i.e.,

$$a_{ij} = 0 \quad \text{if } i \neq j \tag{8.2}$$

and consider the question of estimating the size of B in order to get the existence of linearly independent solutions x_1, \dots, x_n of (8.1), where $x_k = (x_k^1, \dots, x_k^n)$ for $k = 1, \dots, n$, such that $x_k^i(t)/x_k^k(t) \rightarrow 0$ if $t \rightarrow \infty$ and $i \neq k$. In particular, if $B(t) = 0$ for every t and $x_k(t_0)$ is equal to the k th vector of the canonical basis of \mathbb{R}^n for some $t_0 \in \mathbb{R}$ then clearly x_k are linearly independent and $x_k^i = 0$ for $i \neq k$. If B is nonzero then such estimates were obtained by Perron and later they were improved by Szmydtówna in [81] and Onuchic in [55] using the method of Ważewski. Here we follow [55].

THEOREM 8.1 (compare Theorem II-1 in [55]). *Assume (8.2). Let $R > 0$ and let $h : [R, \infty) \rightarrow (0, \infty)$ be a continuous function such that for all $i \neq j$,*

$$|a_{ii}(t) - a_{jj}(t)| < h(t) \quad \text{for every } t \geq R, \tag{8.3}$$

$$\int_R^\infty |b_{ij}(t)| e^{H(t)} dt < \infty, \tag{8.4}$$

$$\int_R^\infty |b_{ii}(t) - b_{jj}(t)| e^{H(t)} dt < \infty, \tag{8.5}$$

where $H(t) := \int_R^t h(s) ds$. Then there exist linearly independent solutions x_1, \dots, x_n of (8.1) such that for every $i, k = 1, \dots, n$ and $i \neq k$,

$$\lim_{t \rightarrow \infty} \frac{x_k^i(t)}{x_k^k(t)} = 0.$$

PROOF. Let g and ϕ be functions $\mathbb{R} \rightarrow \mathbb{R}$ given by

$$g(t) := \sum_{i \neq j} (|b_{ii}(t) - b_{jj}(t)| + |b_{ij}(t)|) + e^{-H(t)-t},$$

$$\phi(t) := e^{-H(t)} \int_t^\infty g(s)e^{H(s)} ds.$$

It follows that ϕ is a C^1 -class function satisfying the differential equation

$$\phi'(t) + h(t)\phi(t) + g(t) = 0. \tag{8.6}$$

Moreover,

$$\phi(t) > 0 \quad \text{for every } t \in \mathbb{R} \tag{8.7}$$

since the last term in $g(t)$ is greater than 0 and

$$\lim_{t \rightarrow \infty} \phi(t) = 0 \tag{8.8}$$

since (8.4) and (8.5) hold. In particular, there exists $T > R$ such that

$$\phi(t) < 1 \quad \text{if } t > T. \tag{8.9}$$

For every $k = 1, \dots, n$ put

$$V_k := \{(t, v) \in \mathbb{R} \times \mathbb{R}^n : t > T, v^k \neq 0, |v^i| < \phi(t)|v^k| \ \forall i \neq k\}.$$

For $i \neq k$ define

$$L^i := \{(t, v) \in \mathbb{R} \times \mathbb{R}^n : t > T, v^k \neq 0, |v^i| = \phi(t)|v^k|, |v^j| \leq \phi(t)|v^k| \ \forall j \neq k\}.$$

Equation (8.1) generates a flow in the extended phase space $\mathbb{R} \times \mathbb{R}^n$. We show that

$$E_k := \bigcup_{i \neq k} L^i$$

is the set of egress points of V_k with respect to that flow and each egress point is a strict egress point. To this aim it suffices to prove that

$$(1, A(t)v + B(t)v) \cdot \nabla \ell^i(t, v) > 0 \quad \text{for } (t, x) \in L^i, \tag{8.10}$$

where

$$\ell^i : \mathbb{R} \times \mathbb{R}^n \ni (t, v) \rightarrow \frac{1}{2}((v^i)^2 - \phi^2(t)(v^k)^2) \in \mathbb{R}.$$

Indeed, the only solutions passing through $\partial V_k \setminus E_k$ are the zero solution and solutions through $t = T$, hence no one of them initiates at V_k . For a proof of (8.10), let $(t, v) \in L^i$. We have

$$\begin{aligned} & (1, A(t)v + B(t)v) \cdot \nabla \ell^i(t, v) \\ &= \phi^2(t)(v^k)^2(a_{ii}(t) - a_{kk}(t) + b_{ii}(t) - b_{kk}(t)) - \phi'(t)\phi(t)(v^k)^2 \\ &\quad - \phi^2(t)v^k \sum_{j \neq k} b_{kj}(t)v^j + v^i \sum_{j \neq i} b_{ij}(t)v^j \end{aligned}$$

because $(v^i)^2 = \phi^2(t)(v^k)^2$. Since (8.6), (8.7), and (8.9) hold, and $|v^j| \leq \phi(t)|v^k|$ for every j , we get the following estimates

$$\begin{aligned} & (1, A(t)v + B(t)v) \cdot \nabla \ell^i(t, v) \\ & \geq \phi^2(t)(v^k)^2(a_{ii}(t) - a_{kk}(t) + b_{ii}(t) - b_{kk}(t)) - \phi'(t)\phi(t)(v^k)^2 \\ & \quad - \phi^3(t)(v^k)^2 \sum_{j \neq k} |b_{kj}(t)| - \phi^2(t)(v^k)^2 \sum_{j \neq i} |b_{ij}(t)| \\ & \geq \phi(t)(v^k)^2 \left(-\phi'(t) - |a_{kk}(t) - a_{ii}(t)|\phi(t) - |b_{kk}(t) - b_{ii}(t)| \right. \\ & \quad \left. - \sum_{j \neq k} |b_{kj}(t)| - \sum_{j \neq i} |b_{ij}(t)| \right) \\ & > \phi^2(t)(v^k)^2(-\phi'(t) - h(t)\phi(t) - g(t)) = 0, \end{aligned}$$

hence (8.10) is proved. Thus

$$W_k := V_k \cup E_k$$

is a Ważewski set and E_k is its exit set. Choose an $\varepsilon > 0$ such that if $M = (m_{ij})$ is an $(n \times n)$ -matrix satisfying $m_{ii} = 1$ and $|m_{ij}| < \varepsilon$ for $i \neq j$ then M is nondegenerate. Let t_0 be such that $\phi(t_0) < \varepsilon$. Define

$$Z_k := \{(t, v) \in \mathbb{R} \times \mathbb{R}^n : t = t_0, v^k = 1, |v^i| \leq \phi(t_0) \forall i \neq k\}.$$

Thus $Z_k \subset W_k$, Z_k is homeomorphic to the disk D^{n-1} , and $Z_k \cap E_k$ is homeomorphic to the sphere S^{n-2} , hence it is not a retract of Z_k . Moreover, there is a retraction

$$r = (r_0, r_1, \dots, r_n) : E_k \rightarrow Z_k \cap E_k$$

given by

$$r_0(t, v) = t_0, \quad r_k(t, v) = 1,$$

$$r_i(t, v) = \frac{\phi(t_0)}{\phi(t)} \frac{v^i}{|v^k|} \quad \text{for } 1 \leq i \neq k$$

since (8.7) holds. It follows by the original Ważewski theorem (see Corollary 2.2) that there exists a solution x_k of (8.1) such that

$$\begin{aligned} (t_0, x_k(t_0)) &\in Z_k \setminus E_k, \\ (t, x_k(t)) &\in V_k \quad \text{for } t \geq t_0. \end{aligned}$$

It follows by the choice of t_0 and ε that the matrix having the vectors $x_k(t_0)$ as the columns for $k = 1, \dots, n$, is nondegenerate, hence the solutions x_1, \dots, x_n are linearly independent. Moreover, if $i \neq k$,

$$|x_k^i(t)| < \phi(t) |x_k^k(t)|$$

for every $t \geq t_0$, hence the theorem follows by (8.8). □

8.2. Two-point boundary value problems

It was already indicated in [85] how to apply the Ważewski theorem in proofs of the existence of solutions of two-point boundary value problems characterized by separate conditions at the initial and final values of time (like (1.10); compare Example 1.2). Later, there appeared several papers on those applications, for example [5,7,26,40,42]. Another approach, based on the Lefschetz fixed point theorem, was applied in [74,76] to the periodic problem and its generalizations (see Section 7.5). We illustrate those applications of the Ważewski method by providing a proof of a classical result on the existence of solutions of several boundary value problems associated to the second order scalar differential equation (3.20), i.e.,

$$x'' = g(t, x, x')$$

with continuous $g : \mathbb{R}^3 \rightarrow \mathbb{R}$, satisfying the Bernstein–Nagumo growth conditions. For $a < b$ we consider the boundary-value conditions

$$x(a) = x(b) = 0 \quad \text{(Dirichlet),} \tag{8.11}$$

$$x'(a) = x'(b) = 0 \quad \text{(Neumann),} \tag{8.12}$$

$$\begin{cases} -\alpha x(a) + \beta x'(a) = 0, \\ \gamma x(b) + \delta x'(b) = 0 \end{cases} \quad \text{(Sturm–Liouville; } \alpha, \beta, \gamma, \delta > 0), \tag{8.13}$$

$$\begin{cases} x(a) = x(b), \\ x'(a) = x'(b) \end{cases} \quad \text{(periodic).} \tag{8.14}$$

THEOREM 8.2 (Bernstein–Nagumo). *If there exists an $R > 0$ and a function*

$$\psi : [0, \infty) \rightarrow (0, \infty)$$

such that the following conditions are satisfied:

- (a) $g(t, R, 0) > 0$ and $g(t, -R, 0) < 0$ for every $t \in \mathbb{R}$,
- (b) $\int_0^\infty \sigma \, d\sigma / \psi(\sigma) > R$,
- (c) for every $t \in \mathbb{R}$, $|x| \leq R$ and $v \in \mathbb{R}$,

$$|g(t, x, v)| < \psi(|v|),$$

then the boundary value problems (8.11)–(8.14) associated to (3.20) have solutions whose images are contained in the interval $[-R, R]$.

PROOF. Assume that (3.20) satisfies the uniqueness property. Let $\Psi : [0, \infty) \rightarrow [0, \infty)$ be defined as

$$\Psi(u) := \int_0^u \frac{\sigma \, d\sigma}{\psi(\sigma)}.$$

Put

$$W := [a, b] \times \{(x, y) \in \mathbb{R}^2 : |x| \leq R - \Psi(|y|)\} \subset \mathbb{R}^3.$$

We prove that W is an isolating segment for (3.21). Observe first that W is compact by (b). Define functions ℓ , m , n^+ , and n^- by

$$\begin{aligned} \ell(t, x, y) &:= t - b, & m(t, x, y) &:= a - t, \\ n^\pm(t, x, y) &:= \pm x - R + \Psi(|y|), \end{aligned}$$

where $(t, x, y) \in \mathbb{R}^3$. W is therefore a generalized polyfacial set determined by $\{\ell, m, n^+, n^-\}$. Since

$$(1, y, g(t, x, y)) \cdot \nabla n^\pm(t, x, y) = \frac{|y|}{\psi(|y|)} (\pm(\operatorname{sgn} y)\psi(|y|) - g(t, x, y)),$$

it follows by (a), (c), (3.22), and (3.23) that $\operatorname{int} W$ is a generalized polyfacial set for (3.21), and moreover, W is an isolating segment such that the proper exit and entrance sets are equal to, respectively,

$$\begin{aligned} W^{--} &= \{(t, x, y) \in W : xy \geq 0, |x| = R - \Psi(|y|)\}, \\ W^{++} &= \{(t, x, y) \in W : xy \leq 0, |x| = R - \Psi(|y|)\}. \end{aligned}$$

Both $W^{\pm\pm}$ consist of two disjoint strips, each of which is equal to an arc in \mathbb{R}^2 multiplied by $[a, b]$. It follows that

$$\Lambda_W = \chi(W_a) - \chi(W_a^{--}) = 1 - 2 = -1,$$

hence Corollary 7.3 implies that the periodic problem (8.14) has a solution. For the other problems let us consider the sets $Z \subset W$ and $Y \subset W^-$ such that

$$Z := \{(a, x, y) \in W : -\alpha x + \beta y = 0\},$$

$$W^- \setminus Y = \{(b, x, y) \in W : \gamma x + \delta y = 0\},$$

where $\alpha, \beta, \gamma, \delta \geq 0, \alpha + \beta > 0$, and $\gamma + \delta > 0$. It follows that Z is connected, $Z \cap W^- \subset Y$ consists of two points, and $W^- \setminus Y$ separates W^- into two disjoint parts each of which contains a point of $Z \cap Y$. Thus $Z \cap Y$ is a retract of Y and it is not a retract of Z . Since there are no saturated solutions contained in W , Corollary 2.2 implies that the problem

$$-\alpha x(a) + \beta y(a) = 0, \quad \gamma x(b) + \delta y(b) = 0$$

has a solution. Thus all the problems (8.11), (8.12), and (8.13) have solutions. In the case (3.20) does not satisfy the uniqueness property, an approximating approach similar to the one described in the proof of Theorem 3.1 leads to the conclusion. □

8.3. Detection of chaotic dynamics

Isolating segments were applied in proofs of results concerning the existence of chaotic dynamics generated by a time-periodic nonautonomous equation. Like in Section 7.5, we assume $w : \mathbb{R} \times M \rightarrow TM$ is a time-dependent vector-field on the right-hand side of Equation (3.8) satisfying the uniqueness property. We assume, moreover, that $t \rightarrow w(t, x)$ is T -periodic for all $x \in M$. Recall that in this case fixed points of the Poincaré map $\Phi_{0,T}$ are the initial points of T -periodic solutions and

$$\Phi_{0,nT} = \Phi_{0,T}^n$$

by (7.5). The concept of chaotic dynamics of (3.8) refers to a chaotic behavior of the Poincaré map in the following sense. For a positive integer r put

$$\Sigma_r := \{1, \dots, r\}^{\mathbb{Z}},$$

i.e., the set of bi-infinite sequences of r symbols, and let the *shift map* be given by

$$\sigma : \Sigma_r \ni (\dots, s_{-1}.s_0, s_1, \dots) \rightarrow (\dots, s_0.s_1, s_2, \dots) \in \Sigma_r.$$

DEFINITION 8.1. Equation (3.8) is called Σ_r -chaotic provided there is a compact set $I \subset M$, invariant with respect to $\Phi_{0,T}$, and a map $g : I \rightarrow \Sigma_r$ such that:

- (a) g is continuous and surjective,
- (b) $\sigma \circ g = g \circ \Phi_{0,T}$,
- (c) for every n -periodic sequence $s \in \Sigma_r$ its inverse image $g^{-1}(s)$ contains at least one n -periodic point of $\Phi_{0,T}$.

It follows by (c) that a Σ_r -chaotic equation has periodic solutions with minimal periods nT for every $n \in \mathbb{N}$.

THEOREM 8.3 (compare Theorem 2 in [79]). *Assume that compact ENRs W and Z are periodic isolating segments over $[0, T]$ for Equation (3.8), and*

- (a) $(W_0, W_0^{--}) = (Z_0, Z_0^{--})$,
- (b) $Z \subset W$,
- (c) $\mu_Z = \mu_W \circ \mu_W = \text{id}_{H(W_0, W_0^{--})}$,
- (d) $\Lambda_W \neq \chi(Z_0) - \chi(Z_0^{--}) \neq 0$.

Then (3.8) is Σ_2 -chaotic.

PROOF. We present a sketch of the proof in [79]. Let

$$\sigma := \sigma_Z^+$$

be the escape-time function for Z . Define the set I as

$$I := \bigcap_{n=-\infty}^{\infty} \{x \in W_0: \Phi_{0,nT+t}(x) \in W_t \ \forall t \in [0, T]\}.$$

It follows by (a) that $\sigma(0, x)$ is defined for every $x \in W_0$. If $x \in I$ then either $\sigma(0, x) < T$ or $\sigma(0, x) = T$ and $\Phi_{0,T} \in W_0 \setminus W_0^{--}$. Indeed, assume on the contrary that $\sigma(0, x) = T$ and $\Phi_{0,T} \in W_0^{--}$. Thus $\Phi_{0,T+\varepsilon} \notin W_\varepsilon$ for a small $\varepsilon > 0$ by (7.5), which contradicts to the definition of I . Define

$$J_Z := \{x \in I: \sigma(0, x) = T, \ \Phi_{0,T} \in W_0 \setminus W_0^{--}\},$$

$$J_W := \{x \in I: \sigma(0, x) < T\}.$$

It follows by the continuity of σ that J_Z and J_W are compact disjoint sets and

$$I = J_Z \cup J_W.$$

We use the letters Z and W also as the two symbols in the definition of Σ_2 , i.e., we put

$$\Sigma_2 := \{Z, W\}^{\mathbb{Z}}.$$

To a point $x \in I$ we attach a symbol $p(x) \in \{Z, W\}$ by the rule $p(x) = Z$ if $x \in J_Z$ and $p(x) = W$ if $x \in J_W$. Define

$$g: I \ni x \rightarrow \{p(\Phi_{0,nT}(x))\}_{n=-\infty}^{\infty} \in \Sigma_2.$$

Since J_Z and J_W are disjoint, g is continuous. Since periodic sequences are dense in Σ_2 , in order to prove the theorem it suffices to show that the inverse image of each n -periodic sequence in Σ_2 contains an n -periodic point of $\Phi_{0,T}$. To a sequence

$$(V_0, \dots, V_{n-1}) \in \{Z, W\}^{\{0, \dots, n-1\}}$$

we attach a periodic isolating segment $V_0 \cdots V_{n-1}$ over $[0, nT]$ and a set $J_{V_0 \cdots V_{n-1}}$ (extending the notation J_Z and J_W) defined by

$$\begin{aligned} V_0 \cdots V_{n-1} &:= \{(kT + t, x) : k \in \{0, \dots, n-1\}, t \in [0, T], x \in V_k\}, \\ J_{V_0 \cdots V_{n-1}} &:= \{x \in I : \Phi_{0,T}^k(x) \in J_{V_k} \forall k \in \{0, \dots, n-1\}\}. \end{aligned}$$

The sets $J_{V_0 \cdots V_{n-1}}$ over all n -element sequences from $\{Z, W\}^{\{0, \dots, n-1\}}$ form a compact and disjoint covering of I . In order to prove the theorem it suffices to prove that for every n each set $J_{V_0 \cdots V_{n-1}}$ contains a fixed point of $\Phi_{0,nT}$. Indeed, the image of that point under the map g is the n -periodic sequence

$$(\dots, V_{n-1}.V_0, \dots, V_{n-1}, V_0, \dots) \in \Sigma_2.$$

Recall, that the set K_{W^n} , where $W^n := W \cdots W$ (n times), consists of all fixed points of $\Phi_{0,nT}$ contained in I (see Theorem 7.7). Since $K_{W^n} \cap J_{V_0 \cdots V_{n-1}}$ is compact and open in the set of all fixed points of $\Phi_{0,nT}$, its fixed point index is defined, and, by (d), in order to prove the theorem it suffices to show that if W appears in the sequence $(V_0, \dots, V_{n-1}) \in \{Z, W\}^{\{0, \dots, n-1\}}$ exactly k times then

$$\text{ind}(\Phi_{0,nT}, K_{W^n} \cap J_{V_0 \cdots V_{n-1}}) = \begin{cases} \chi(Z_0, Z_0^{--}), & \text{if } k = 0, \\ (-2)^{k-1}(\Lambda_W - \chi(Z_0, Z_0^{--})), & \text{if } k \geq 1. \end{cases}$$

That equation is a consequence of Theorem 7.7 and some combinatorial calculations; we skip its proof here referring to the proof of Lemma 1 in [79]. □

EXAMPLE 8.1 (compare [79]). The planar equation

$$\dot{z} = (1 + e^{i\phi t} |z|^2) \bar{z} \tag{8.15}$$

is Σ_2 -chaotic if $0 < \phi \leq 0.495$. The proof in [79] is based on the existence of two isolating segments W and Z over $[0, 2\pi/\phi]$ for (8.15) which are similar to the ones shown in Figure 9 (with W at the top and Z at the bottom). It follows by the figure that $\Lambda_W = 1$, $\chi(W_0) = 1$, $\chi(W_0^{--}) = 2$, hence Theorem 8.3 implies the result.

In [79], the parameter values $0 < \phi \leq 1/288$ were considered only. The extension to the other values was given in [95]. Actually, in [95] it was proved that (8.15) is Σ_3 -chaotic in the considered range of ϕ . The equation was further investigated in [94,96], where the

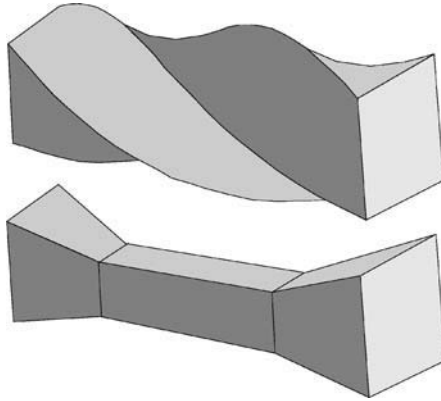

Fig. 9.

existence of infinitely many distinct homoclinic solutions to the zero one was proved. Generalizations of Theorem 8.3 and extensions of results on (8.15) to more general classes of equations were given, among others, in [91–93,97]. Another approach to chaotic dynamics based on the existence of suitably located isolating blocks or segments is presented in [29,75].

9. Conley index

Using the notion of isolating block we present the definition of the Conley index and provide its basic properties. In particular, we indicate its relation to the Ważewski method. We do not present more advanced topics of the theory of the index; for them we refer to [50].

9.1. Isolated invariant sets and the Conley index

Let X be a metrizable locally compact space and let ϕ be a local flow on X .

DEFINITION 9.1. A compact set $S \subset X$ is called an *isolated invariant set* provided there exists U , a neighborhood of S , such that $S = \text{Inv}(U)$. Such an U is called an *isolating neighborhood for S* .

EXAMPLE 9.1. Let A be a real $n \times n$ -matrix, let U be an open neighborhood of 0 in \mathbb{R}^n , and let $f : U \rightarrow \mathbb{R}^n$ be a C^1 -class function. Denote by ϕ the local flow on U generated by the equation

$$\dot{x} = Ax + f(x).$$

Assume that

$$f(x) = o(|x|) \quad \text{as } x \rightarrow 0$$

and there are no purely imaginary eigenvalues of A . Then the one-point set $\{0\}$ is an isolated invariant set for ϕ . Indeed, by the Grobman–Hartman theorem ϕ is conjugated in a neighborhood of 0 to the flow generated by the linear vector-field $x \mapsto Ax$ which does not have any bounded solutions except of the trivial one.

In an obvious way Example 9.1 generalizes to a stationary point of the local flow generated by a C^1 -class vector-field $v : M \rightarrow TM$ on a Riemannian manifold M .

DEFINITION 9.2. A stationary point $x_0 \in M$ is called *hyperbolic of index k* if the differential $d_{x_0}v$ does not have eigenvalues on the imaginary axis and there are exactly k eigenvalues (counted with multiplicities) with the positive real part.

It follows that if x_0 is a hyperbolic point then $\{x_0\}$ is an isolated invariant set.

EXAMPLE 9.2. Assume that ϕ is a gradient-like local flow (see Section 6.2). It is not difficult to observe that if x_0 is a stationary point and there is a compact neighborhood U of x_0 such that there are no other stationary points in U then the one-point set $\{x_0\}$ is an isolated invariant set and U is its isolating neighborhood. It follows that isolated critical points of a smooth functional $g : M \rightarrow \mathbb{R}$ are isolated invariant sets of the local flow generated by (6.1).

If B is an isolating block then it is an isolating neighborhood for $S = \text{Inv}(B)$. In this case we say that B is an *isolating block for S* . We recall in a more comprehensive version the first one of the two main theorems stated in Section 1.3:

THEOREM 9.1 (First Conley Theorem). *If U is a neighborhood of an isolated invariant set S then there exists an isolating block B for S such that $B \subset U$. Moreover, if ϕ is smooth (i.e., of C^∞ -class) local flow on a smooth manifold then B can be chosen as a smooth submanifold with corners such that B^- and B^+ are smooth submanifolds with boundary.*

PROOF. We provide the idea of the proof given in the paper [90] in the smooth case. Let U be an open isolating neighborhood of S . It is proved in [90] that there exist continuous functions $\ell, m : U \rightarrow [0, \infty)$ such that

$$\text{Inv}^-(U) = \ell^{-1}(0), \quad \text{Inv}^+(U) = m^{-1}(0),$$

ℓ is of C^∞ -class outside of $\text{Inv}^-(U)$ and m is of C^∞ -class outside of $\text{Inv}^+(U)$, and

$$\begin{aligned} \frac{d}{dt}(\ell(\phi_t(x))) &< 0, & \text{if } x \notin \text{Inv}^-(U), \\ \frac{d}{dt}(m(\phi_t(x))) &> 0, & \text{if } x \notin \text{Inv}^+(U). \end{aligned}$$

Let V be a compact neighborhood of S contained in U . It follows by the compactness of V ,

$$S = V \cap \bigcap_{\varepsilon > 0} \ell^{-1}([0, \varepsilon]) \cap \bigcap_{\delta > 0} m^{-1}([0, \delta])$$

and, moreover, there exist an $\varepsilon_0 > 0$ such that if $0 < \varepsilon \leq \varepsilon_0$ and $0 < \delta \leq \varepsilon_0$ then

$$V_{(\varepsilon, \delta)} := V \cap \ell^{-1}([0, \varepsilon]) \cap m^{-1}([0, \delta])$$

is a compact neighborhood of S . By the Sard theorem, choose $(\varepsilon, \delta) \in (0, \varepsilon_0)^2$ which is a regular value of the map $(\ell, m) : V \rightarrow \mathbb{R}^2$. For that value, $\text{int } V_{(\varepsilon, \delta)}$ is a regular polyfacial set determined by $\{\ell - \varepsilon, m - \delta\}$, hence, by Remark 3.1, the set $V_{(\varepsilon, \delta)}$ is an isolating block satisfying the required properties. For a proof in the purely topological case we refer to [18] or [70, Chapter 22]. □

REMARK 9.1. In the smooth case it was additionally proved that $\text{int } B$ is a regular polyfacial set, hence if v is the vector field generating ϕ and w is a vector field sufficiently close to v on B then B is also an isolating block for the local flow generated by w .

REMARK 9.2. If the phase space of ϕ is a 2-dimensional manifold then it follows by the construction provided in the proof of [72, Theorem 3.3] that there exists an isolating block B for S such that B is a topological manifold with boundary and B^- is its submanifold with boundary.

Now our aim is to prove the Second Conley Theorem which we recall below. It is preceded by a lemma which will be used in the proof. (Recall that the concept of B -invariant subset of B is given in Definition 7.2).

LEMMA 9.1. *If B is an isolating block and Z is a B -invariant compact neighborhood of $\text{Inv}(B)$ then*

$$[Z/Z^-, *] = [B/B^-, *].$$

PROOF. By the continuity of ϕ , it is easy to prove that Z is a neighborhood of A , hence Lemma 7.1(i) implies that $B_n \subset Z$ for some $n \in \mathbb{N}$. Since the inclusion induces a homeomorphism of the compact spaces Z/Z^- and $Z \cup B^-/B^-$, it follows by (ii) in that lemma,

$$[Z/Z^-, *] = [Z \cup B^-/B^-, *] = [D_n/B^-, *] = [B/B^-, *],$$

which finishes the proof. □

THEOREM 9.2 (Second Conley Theorem). *Let S be an isolated invariant set and let B and \tilde{B} be isolating blocks for S . Then*

$$[B/B^-, *] = [\tilde{B}/\tilde{B}^-, *].$$

PROOF. As in Section 7, we denote by A, σ^\pm , etc. the sets and functions corresponding to the block B . The analogous sets and functions for \tilde{B} we denote by $\tilde{A}, \tilde{\sigma}^\pm$, etc. Without loss of generality we assume

$$B \subset \tilde{B}.$$

(In the other case one can find an isolating block for S contained in the intersection of the blocks B and \tilde{B} by Theorem 9.1, and then compare $[B/B^-, *]$ and $[\tilde{B}/\tilde{B}^-, *]$ to the homotopy type corresponding to that block.) The proof will be performed in a few steps. Below we use the following notation for intervals: if $a \in \mathbb{R}$ then $[a, a]$ is the one point set $\{a\}$ and (a, a) is equal to \emptyset .

Step 1. For every $n \in \mathbb{N}$,

$$[B/B^-, *] = [B_n/B_n^-, *].$$

(Recall that B_n is defined in Section 7.2.) It immediately follows by Lemmas 7.1(i) and 9.1.

Step 2. There exists $n \in \mathbb{N}$, $n \geq 1$, such that

$$\begin{aligned} \phi(x, (0, \tilde{\sigma}^+(x))) \cap B_n &= \emptyset, & \text{if } x \in B_n^-, \\ \phi(x, (-\tilde{\sigma}^-(x), 0)) \cap B_n &= \emptyset, & \text{if } x \in B_n^+. \end{aligned}$$

By the symmetry of notation, we need to justify the first condition only. Assume on the contrary that for every n there exists $x_n \in B_n^-$ and $0 < t_n < \tilde{\sigma}^+(x_n)$ such that $\phi(x_n, t_n) \in B_n^+$. We can assume that $x_n \rightarrow x_0$ and $t_n \rightarrow t_0$ as $n \rightarrow \infty$. $A^\pm = \bigcap_n B_n^\pm$ by Lemma 7.1, hence we have

$$x_0 \in A^- \subset \text{Inv}^-(B) \subset \text{Inv}^-(\tilde{B}).$$

If $t_0 = \infty$ then $x_0 \in \text{Inv}^+(\tilde{B})$ and thus $x \in S$ which is impossible. If $t_0 < \infty$ then $\phi(x_0, t_0) \in A^+$, hence again $x \in S$ and the assertion is proved.

Step 3. Since now we assume that n satisfies the conclusion of Step 2. Then $\tilde{\sigma}^\pm(x) < \infty$ for every $x \in B_n^\pm$. Indeed, in the other case the positive or negative limit set of x is contained in \tilde{B} and contains points outside of the interior of B , which is impossible.

Step 4. By Step 3, we can define compact sets

$$M := \bigcup_{x \in B_n^+} \phi(x, [-\tilde{\sigma}^-(x), 0]), \quad N := \bigcup_{x \in B_n^-} \phi(x, [0, \tilde{\sigma}^+(x)]).$$

It follows by Step 2 that $M \cap B_n = B_n^+$ and $N \cap B_n = B_n^-$. Moreover, by Lemma 9.1,

$$[\tilde{B}/\tilde{B}^-, *] = [B_n \cup M \cup N/N^-, *].$$

Step 5.

$$[B_n \cup M \cup N/N^-, *] = [B_n \cup N/N^-, *].$$

This is obvious since B_n^+ is a strong deformation retract of M .

Step 6. Finally,

$$[B_n \cup N/N^-, *] = [B_n/B_n^-, *].$$

In order to prove that assertion recall that $n \geq 1$ and observe that

$$B_n = \{x \in B_n: \sigma^+(x) \geq 1\} \cup \phi(B_n^- \times [-1, 0]),$$

$$B_n \cup N = \{x \in B_n: \sigma^+(x) \geq 1\} \cup \bigcup_{x \in B_n^-} \phi(x, [-1, \tilde{\sigma}^+(x)]).$$

Since the second compounds are homeomorphic each to the other such that the set $\phi_{-1}(B_n^-)$ remains intact and B_n^- is transformed to N^- , there exists a homeomorphism

$$(B_n, B_n^-) \rightarrow (B_n \cup N, N^-)$$

and the assertion follows. We get the conclusion of the theorem by combining the equations in Steps 1, 4, 5, and 6. □

As it was pointed out in Section 1.3, Theorems 9.1 and 9.2 lead to Definition 1.3 of the Conley index:

$$h(\phi, S) := [B/B^-, *]$$

for an arbitrary isolating block B for S . Actually, in order to define the Conley index, a more general notion of *index pair* (see [50, Definition 3.4]) can be used.

9.2. Properties of the Conley index

At first we provide the definition of the continuation (i.e., homotopy) relation between isolated invariant sets. Assume that ϕ and ψ are local flows on a metrizable locally compact space X and let S and T be isolated invariant sets for ϕ and, respectively, ψ .

DEFINITION 9.3. We say that pairs (ϕ, S) and (ψ, T) are *related by continuation* (denoted $(\phi, S) \simeq (\psi, T)$) if there exists a local flow Φ on $X \times [0, 1]$, an isolated invariant set S^* for Φ , and local flows ϕ^σ on X , $\sigma \in [0, 1]$, such that $\Phi_t(x, \sigma) = (\phi_t^\sigma(x), \sigma)$, $\phi_0 = \phi$, $\phi_1 = \psi$, $S = \{x: (x, 0) \in S^*\}$, and $T = \{x: (x, 1) \in S^*\}$.

The relation of continuity between isolated invariant sets provides no information on their topology. In particular, a nonempty set can be continued to the empty one, and a connected set can split by continuation into a nonconnected one as we see in the following examples.

EXAMPLE 9.3. Take a family of local flows ϕ^λ generated by

$$\dot{x} = x^2 + \lambda$$

on the real line. It follows that

$$(\phi^0, \{0\}) \simeq (\phi^1, \emptyset).$$

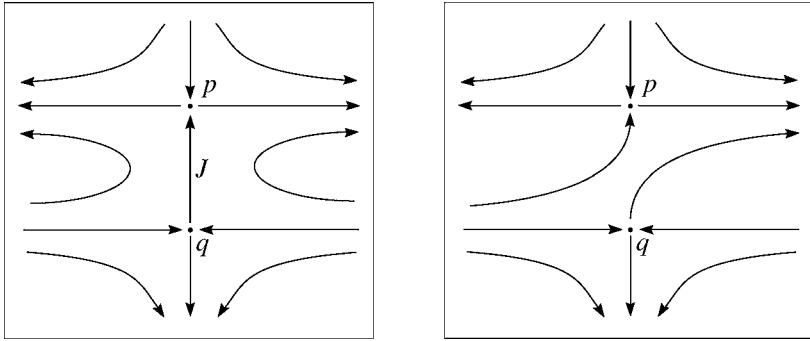

Fig. 10.

EXAMPLE 9.4. Let p and q be two stationary hyperbolic points of local flows ϕ and ψ in the plane as shown on Figure 10, where the left and right drawing represent the phase portrait of ϕ and, respectively, of ψ . Let the isolated invariant set for ϕ is equal to the set consisting of p, q , and the whole trajectory J connecting p and q (i.e., $J = \phi(y), \alpha(y) = q, \text{ and } \omega(y) = p$). The flow ψ is obtained from ϕ by a perturbation which splits J into two disjoint unbounded trajectories. Since that perturbation can be arbitrarily small,

$$(\phi, \{p, q\} \cup J) \simeq (\psi, \{p, q\}).$$

In the sequel we need also the notion of the product $\phi \times \psi$, where ϕ is a local flow on X and ψ is a local flow on Y . It is given by

$$(\phi \times \psi)_t(x, y) := (\phi_t(x), \psi_t(y)).$$

In the smooth case it corresponds to the Cartesian product of the generating vector-fields.

The following theorem provides the main properties of the Conley index. They are counterparts of the properties (i)–(iv) of the fixed point index given in Proposition 5.7.

THEOREM 9.3.

- (i) (Ważski Property) *If $h(\phi, S) \neq \bar{0}$ then $S \neq \emptyset$.*
- (ii) (Additivity) *If S and T are isolated invariant sets of ϕ and $S \cap T = \emptyset$ then*

$$h(\phi, S \cup T) = h(\phi, S) \vee h(\phi, T).$$

- (iii) (Multiplicativity) *If ϕ is a local flow on X and ψ is a local flow on Y , S and T are isolated invariant sets of ϕ and ψ , respectively, then*

$$h(\phi \times \psi, S \times T) = h(\phi, S) \wedge h(\psi, T).$$

- (iv) (Continuation Property) *If $(\phi, S) \simeq (\psi, T)$ then $h(\phi, S) = h(\psi, T)$.*

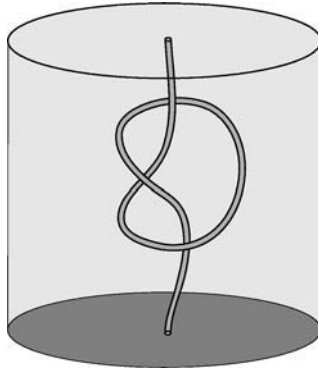

Fig. 11.

PROOF. Ad (i). This is an immediate consequence of Corollary 2.5 and Lemma 5.1.

Ad (ii). If B and \tilde{B} are isolating blocks for S and T , respectively, and $B \cap \tilde{B} = \emptyset$ then $B \cup \tilde{B}$ is also an isolating block for ϕ and the result follows by the definition of the index.

Ad (iii). For B and \tilde{B} as above the set $B \times \tilde{B}$ is an isolating block for $S \times T$, hence the result follows.

Ad (iv). If the local flow ϕ is smooth, the result is a consequence of Remark 9.1, since in this case $h(\phi, S)$ is locally constant with respect to the change of the vector-field generating ϕ . For a proof in the general case we refer to [70, Chapter 23]. \square

Theorem 9.3(i) is a version of the Ważewski theorem. It is weaker than Corollary 2.5 as it can be shown in the following example:

EXAMPLE 9.5 (compare II.2 in [21]). Let $B \subset \mathbb{R}^3$ be given by

$$B := D^2 \times [0, 1] \setminus P,$$

where D^2 denotes the disk $\{x \in \mathbb{R}^2: |x| \leq 1\}$ and P is a knotted thin open pipe P as shown in Figure 11, i.e., $P \subset D^2 \times [0, 1]$ and there exists a homeomorphism

$$h: U \times [0, 1] \rightarrow P,$$

where U is equal to $\{x \in \mathbb{R}^2: |x| < r\}$ for some $0 < r < 1$, such that

$$h(U \times \{0\}) = U \times \{0\}, \quad h(U \times \{1\}) = U \times \{1\}.$$

Assume that B is an isolating block for a local flow ϕ in \mathbb{R}^3 such that the bottom of B is equal to B^- . The exit set B^- is not a strong deformation retract of B since they have different fundamental groups, hence Corollary 2.5 implies that

$$S := \text{Inv}(B) \neq \emptyset.$$

On the other hand, $h(\phi, S) = [B/B^-, *]$ is the trivial pointed homotopy type and therefore it does not provide any information on S . Indeed, since B is compact, the inclusion $B \hookrightarrow B \cup (D^2 \times \{0\})$ induces a homeomorphism

$$B/B^- \rightarrow B \cup (D^2 \times \{0\}) / (D^2 \times \{0\}).$$

The set $\partial U \times [0, 1] \cup \bar{U} \times \{0\}$ is a strong deformation retract of $\bar{U} \times [0, 1]$, hence $B \cup (D^2 \times \{0\})$ is a strong deformation retract of $D^2 \times [0, 1]$. Lemma 5.1 implies

$$\begin{aligned} [B/B^-, *] &= [B \cup (D^2 \times \{0\}) / (D^2 \times \{0\}), *] \\ &= [D^2 \times [0, 1] / (D^2 \times \{0\}), *] = \bar{0}. \end{aligned}$$

In applications of the Conley index it is convenient to consider its various reductions, for example $H(h(\phi, S))$ and $\chi(h(\phi, S))$ for an arbitrary homology or cohomology functor H and the corresponding Euler characteristic, the category $\text{cat}(h(\phi, S))$, and the cup-length $\ell(h(\phi, S))$. In particular, by Remark 5.1,

$$\check{H}^*(h(\phi, S)) = \check{H}^*(B, B^-)$$

for arbitrary isolating block B for S . (In fact, that equation holds for every homology or cohomology functor H , compare [68, Section 1.10]; $H(h(\phi, S))$ is called the *homological* or, respectively, the *cohomological Conley index* and usually is denoted by $CH(\phi, S)$.) In the following result we gather information on the isolated invariant set provided by the above mentioned reductions of the Conley index.

THEOREM 9.4. *Let S be an isolated invariant set for a local flow ϕ . Then*

- (i) $\ell(S) \geq \ell(h(\phi, S))$.
- (ii) *If ϕ is smooth then $\text{cat}(S) \geq \text{cat}(h(\phi, S))$.*
- (iii) *If the phase space of ϕ is a 2-dimensional manifold then either S has infinitely many components or $\check{\chi}(S) \geq \chi(h(\phi, S))$.*
- (iv) *If ϕ is smooth and gradient-like then $\#S_0 \geq \text{cat}(h(\phi, S))$, where S_0 denotes the set of stationary points contained in S .*
- (v) *If ϕ is smooth and $T > 0$ then $\text{ind}(\phi_T, S_T) = \chi(h(\phi, S))$, where S_T denotes the set of T -periodic points contained in S .*
- (vi) *If ϕ is smooth then $i(\phi, U) = \chi(h(\phi, S))$ for every open isolating neighborhood U of S .*

PROOF. At first note that the smoothness of ϕ implies the existence of an isolating block B for S such that B and B^- are ENRs by Theorem 9.1.

Ad (i). It follows by Proposition 5.3 and Corollary 7.2.

Ad (ii). It follows by Proposition 5.2 and Theorem 7.1.

Ad (iii). The result is a consequence of Proposition 5.5, (7.2) in Example 7.2, and Remark 9.2.

Ad (iv). It follows by Theorem 7.5.

Ad (v) and (vi). These are consequences of Proposition 5.5 and Theorem 7.6. □

Obviously, the absolute homotopy type of B/B^- also does not depend on isolating block B for S , hence we can define a less accurate invariant than the Conley index h by

$$h'(\phi, S) := [B/B^-]$$

It has similar properties as h . Moreover, by Propositions 5.2, 5.3, and 5.5 we get

$$\ell(h(\phi, S)) \geq \ell(h'(\phi, S)) - 1$$

and, in the case of smooth ϕ ,

$$\text{cat}(h(\phi, S)) \geq \text{cat}(h'(\phi, S)) - 1,$$

$$\chi(h(\phi, S)) = \chi(h'(\phi, S)) - 1,$$

hence the corresponding results to those in Theorem 9.4 hold for h' .

9.3. Examples of Conley indices and an application

In the following results we use the homotopy types

$$\Sigma^k := [S^k, s_0],$$

$$\Pi^k := [\mathbb{R}P^k, p_0],$$

where S^k and $\mathbb{R}P^k$ denote the k -dimensional sphere and real projective space, respectively, and s_0 and p_0 are their arbitrary points. Σ^0 is sometimes denoted by $\bar{1}$ since it is the neutral element for the smash product.

Assume that ϕ is a smooth flow on a Riemannian manifold. At first we calculate the index of a hyperbolic point (see Definition 9.2).

PROPOSITION 9.1. *Assume that x_0 is hyperbolic of index k . Then*

$$h(\phi, \{x_0\}) = \Sigma^k. \tag{9.1}$$

PROOF. By the Grobman–Hartman theorem, ϕ is conjugated in a neighborhood of x_0 to the linear flow ψ of the equation

$$\dot{x} = Ax$$

in \mathbb{R}^n , where $A = (a_{ij})$ is diagonal, $a_{ii} = 1$ for $i = 1, \dots, k$ and $a_{ii} = -1$ for $i = k + 1, \dots, n$. Thus isolating blocks for ϕ in a neighborhood of x_0 and for ψ in a neighborhood of 0 are homeomorphic, hence it suffices to calculate $h(\psi, \{0\})$.

$$B = D^k \times D^{n-k}$$

is an isolating block for $\{0\}$ with respect to ψ and

$$B^- = S^{k-1} \times D^{n-k},$$

hence B/B^- has the same homotopy type as S^k and the result follows. □

EXAMPLE 9.6. Let $g : M \rightarrow \mathbb{R}$ be a Morse function on an n -dimensional Riemannian manifold M . By definition, it means that each its critical point x_0 is nondegenerate, hence, by the Morse lemma, there exists a chart $f : U \rightarrow \mathbb{R}^n$ in a neighborhood of x_0 such that $f(x_0) = 0$ and

$$g(f^{-1}(v)) = g(x_0) - \sum_{i=1}^k v_i^2 + \sum_{i=k+1}^n v_i^2 \tag{9.2}$$

for $v = (v_1, \dots, v_n) \in f(U)$. The number k is independent of the choice of the chart and is called the *Morse index* of x_0 . It follows by (9.2) that x_0 is a hyperbolic point of index k of the local flow ϕ generated by (6.1), hence (9.1) holds.

By the example, the Conley index is a direct generalization of the Morse index (up to the correspondence k vs. Σ^k): it also applies to degenerate isolated critical points of a functional, since they are isolated invariant sets as we have mentioned in Example 9.2. In spite of the fact that functionals used in variational methods operate in infinite-dimensional spaces, hence not locally compact ones, the Conley index finds its application there thanks to the saddle-point reduction method from [2] (compare also Remark 7.2).

Let Γ be a nontrivial periodic orbit of ϕ , i.e., the trajectory $\phi(x)$ of a periodic, non-stationary point x . It is called *hyperbolic of index k* if $d_x P$, the differential at x of the Poincaré map P associated to a section of Γ in a neighborhood of x does not have eigenvalues on the unit circle and there are exactly k eigenvalues (counted with multiplicities) outside of the unit disc. Then the unstable manifold $W^u(\Gamma)$ of Γ is of dimension $k + 1$ and we call Γ *untwisted* (respectively, *twisted*) provided $W^u(\Gamma)$ is orientable (respectively, nonorientable).

PROPOSITION 9.2. *Assume that Γ is hyperbolic of index k . Then Γ is an isolated invariant set and*

- (i) *if $k = 0$ then $h(\phi, \Gamma) = [S^1/\emptyset, *]$,*
- (ii) *if $k \geq 1$ and Γ is untwisted then $h(\phi, \Gamma) = \Sigma^k \vee \Sigma^{k+1}$,*
- (iii) *if $k \geq 1$ and Γ is twisted then $h(\phi, \Gamma) = \Pi^2 \wedge \Sigma^{k-1}$.*

PROOF. We present a sketch of a proof. In the untwisted case one can find an isolating block B for Γ which is homeomorphic to $S^1 \times D^k \times D^{n-k-1}$ such that its exit set B^- corresponds to $S^1 \times S^{k-1} \times D^{n-k-1}$. In the case $k = 0$ the result follows directly. Assume that $k \geq 1$. It follows that $(B/B^-, *)$ has the homotopy type of $(S^1 \times S^k)/(S^1 \times \{s_0\}, *)$, i.e., $[S^1/\emptyset, *] \wedge \Sigma^k$. By the geometric considerations which are shown on Figure 12 in the case $k = 1$, that homotopy type appears to be equal to $\Sigma^k \vee \Sigma^{k+1}$. In drawing 1 on

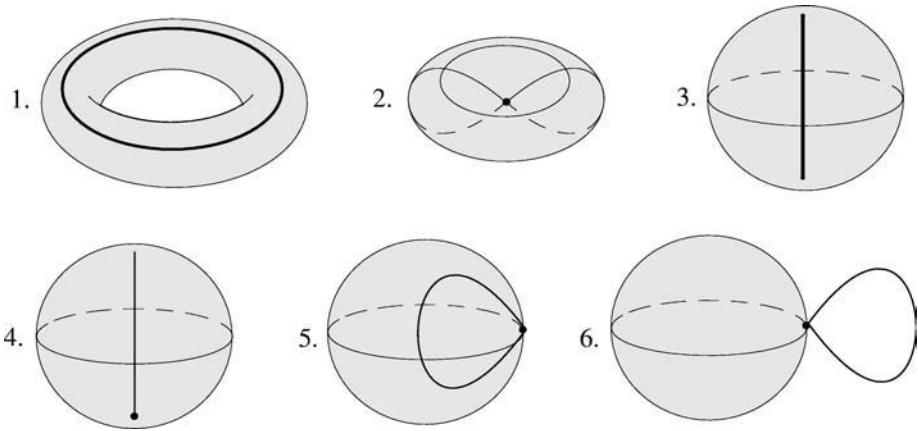

Fig. 12.

the figure, there is the Cartesian product $S^1 \times S^1$ having marked the circle $S^1 \times \{s_0\}$. By collapsing the circle to a point one gets what is seen in drawing 2. The resulting quotient space is homeomorphic to the union of the two-dimensional sphere S^2 with the bar joining its poles divided by the bar. This is marked in drawing 3. In drawing 4, there is a pointed space with the same homotopy type, but here the bar is not collapsed and the south pole is the base point. Without changing the pointed homotopy type, the bar is deformed to the circle inside the sphere in drawing 5. In order to better see that this is in fact the pointed wedge sum $S^1 \vee S^2$, the homeomorphic space with the circle attached outside of the sphere is shown in drawing 6. That argument generalizes to the higher values of k .

If Γ is twisted then B is homeomorphic to $M \times D^{k-1} \times D^{n-k-1}$ such that B^- corresponds to $\partial M \times S^{k-2} \times D^{n-k-1}$, where M is the compact Möbius band and ∂M denotes its geometric boundary. Thus $[B/B^-, *]$ is equal to $\Pi^2 \wedge S^{k-1}$. \square

Recall that in Example 5.1 we have shown that $\Sigma^0 \vee \Sigma^1$ is not the same as $[S^1/\emptyset, *]$, hence (i) in Proposition 9.2 is not of the form (ii) for $k = 0$. Since the Conley index of an attracting hyperbolic orbit Γ is equal to $[S^1/\emptyset, *]$ by (i), and the Conley index of an isolated invariant set S consisting of two hyperbolic points of index 0 and index 1 is equal to $\Sigma^0 \vee \Sigma^1$ by Theorem 9.3(ii), it follows by (iv) of that theorem that there is no continuation between (ϕ, Γ) and (ψ, S) for any two local flows ϕ and ψ . Notice that we essentially used the Conley index h in order to prove that assertion. Its reduction to h' is useless since both the absolute homotopy types $h'(\phi, \Gamma)$ and $h'(\psi, S)$ are equal to $[S^1/\emptyset]$. Moreover, for every homology or cohomology functor H with coefficients in R ,

$$H_q(h(\phi, \Gamma)) \cong H_q(h(\psi, S)) \cong \begin{cases} R, & \text{if } q = 0 \text{ or } q = 1, \\ 0, & \text{if } q \neq 0, 1. \end{cases}$$

Surprisingly, the corresponding result in the case of nonattracting hyperbolic periodic orbits is not true. We provide an example of a hyperbolic periodic orbit of index 1 which continues to the set consisting of two hyperbolic stationary points of index 1 and 2.

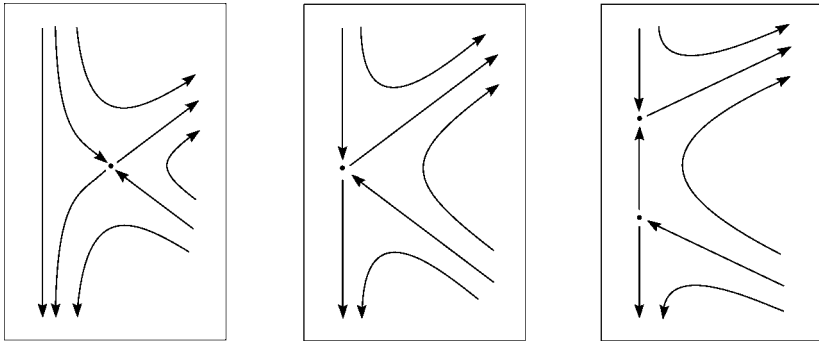

Fig. 13.

EXAMPLE 9.7. We consider a family of local flows ϕ^λ in \mathbb{R}^3 , where $\lambda \in [0, 1]$. For $\lambda \in [0, 2/3]$ let ϕ^λ be generated by the equation

$$\dot{\theta} = 1, \quad \dot{r} = f(r, z, \lambda), \quad \dot{z} = g(r, z, \lambda)$$

in the cylindrical coordinates θ, r, z , where $\theta \in [0, 2\pi)$, $r \geq 0$, and $z \in \mathbb{R}$. Assume that the vector-field (f, g) in $[0, \infty) \times \mathbb{R}$ has the phase portrait given in Figure 13 (where r is the horizontal coordinate and z is the vertical one) for the parameter values $\lambda = 0$ (left), $\lambda = 1/3$ (middle), and $\lambda = 2/3$ (right). Assume that $1/3$ is the only parameter value of $\lambda \in [0, 2/3]$ in which the phase portrait changes, which implies that the right drawing represents also phase portraits at $\lambda \in [0, 1/3)$ and the right one at $\lambda \in (1/3, 2/3]$. It follows that for $\lambda \in [0, 1/3)$ there is a periodic hyperbolic orbit S_λ of index 1 represented by the dot in the left drawing. It collapses at $\lambda = 1/3$ to the one-point set $S_{1/3}$ consisting of the stationary point on the line $r = 0$ which is seen in the middle drawing. For $\lambda \in (1/3, 2/3]$, that point bifurcates into the isolated invariant set S_λ consisting of two hyperbolic points of index 1 (the lower point) and of index 2 (the upper point) and the trajectory connecting them. For the parameter values $\lambda \in (2/3, 1]$ we no longer assume any rotating and we split the connecting trajectory into two unbounded ones in a similar way as it was done for the planar system in Example 9.4 and shown on Figure 10. Thus S_λ for $\lambda \in (2/3, 1]$ consists of two hyperbolic points of index 1 and 2 and

$$(\phi^0, S_0) \simeq (\phi^1, S_1).$$

As an example of application of various properties of the Conley index we present a proof of a result on existence of a bounded solution.

PROPOSITION 9.3 (see I.5 in [21]). *The scalar equation*

$$x^{(n)} = x^2 - 1 \tag{9.3}$$

has a nonconstant solution x such that $x, x', \dots, x^{(n-1)}$ are bounded.

PROOF. We rewrite the proof in [21]—it is also reproduced in [70], where we refer for more detailed calculations. By the change of variables $\tau = t/\varepsilon$ and $z = \varepsilon^n x$ Equation (9.3) is equivalent to

$$\frac{d^n z}{d\tau^n} = z^2 - \varepsilon^{2n},$$

hence to the system

$$z'_i = z_{i+1}, \quad \text{if } i = 1, \dots, n - 1, \quad z'_n = z_n^2 - \varepsilon^{2n}. \tag{9.4}$$

In particular, for $\varepsilon = 0$, (9.4) becomes

$$z'_i = z_{i+1}, \quad \text{if } i = 1, \dots, n - 1, \quad z'_n = z_n^2 \tag{9.5}$$

and we assert that the constant solution 0 is the only bounded solution of (9.5). In order to prove that assertion assume that $z = (z_1, \dots, z_n)$ is a bounded solution. Since $z'_n(t) \geq 0$, the map z_n is constant or increasing. In both cases there exist $\alpha^-, \alpha^+ \in \mathbb{R}$ such that

$$\lim_{t \rightarrow \pm\infty} z_n(t) = \alpha^\pm.$$

Let $\alpha^+ \neq 0$. Then $z'_{n-1}(t)$ is close to α^+ for t near ∞ , hence z_{n-1} is unbounded which contradicts to the assumption. The same holds if $\alpha^- \neq 0$, hence $\alpha^- = \alpha^+ = 0$ and z_n is the constant zero function. It follows that z_{n-1} is a constant function and by a similar argument one concludes that the constant is equal to 0. By repeating that argument we conclude $z_n(t) = \dots = z_1(t) = 0$ for every t . Let ϕ^ε be the local flow generated by (9.4) if $\varepsilon \geq 0$ and by

$$z'_i = z_{i+1}, \quad \text{if } i = 1, \dots, n - 1, \quad z'_n = z_n^2 + \varepsilon^{2n}$$

if $\varepsilon \leq 0$. We have just proved that $\{0\}$ is an isolated invariant set of ϕ^0 . Take an arbitrary isolating block B for $\{0\}$ such that conclusion of Remark 9.1 is satisfied, hence B is also an isolating block for local flows ϕ^ε , where $|\varepsilon| \leq \varepsilon_0$ for some $\varepsilon_0 > 0$. For such an ε define the isolated invariant set S_ε as the invariant part of B with respect to the local flow ϕ^ε . It is easy to see that if $\varepsilon < 0$ then there are no bounded trajectories for ϕ^ε , hence $S_\varepsilon = \emptyset$. By Theorem 9.3(i) and (iv),

$$h(\phi^\varepsilon, S_\varepsilon) = \bar{0} \tag{9.6}$$

if $|\varepsilon| < \varepsilon_0$. Assume now that $\varepsilon > 0$. There are two stationary points p^+ and p^- ,

$$p^\pm = (\pm\varepsilon^n, 0, \dots, 0),$$

and the eigenvalues of the derivative of the vector-field generating ϕ^ε at p^\pm satisfy the characteristic equation

$$\lambda^n = \pm 2\varepsilon.$$

Assume on the contrary that p^\pm are the only bounded trajectories, hence S_ε is equal to the union $\{p^-, p^+\}$ and Theorem 9.3(ii) implies

$$h(\phi^\varepsilon, S_\varepsilon) = h(\phi^\varepsilon, \{p^-\}) \vee h(\phi^\varepsilon, \{p^+\}). \quad (9.7)$$

If n is odd then there are no eigenvalues on imaginary axis for both p^+ and p^- , and if n is even then the same holds for one of p^\pm . Thus, by Proposition 9.1, at least one summand on the right-hand side of (9.7) is not equal to $\bar{0}$ which contradicts to (9.6) by Remark 5.2. \square

9.4. Concluding remarks

We provided only basic facts concerning the Conley index; a more comprehensive introductions to that notion are given in [21] and [70, Chapters 22 and 23]. For some more advanced topics we refer to [50], where the index or its generalizations are defined both for continuous and discrete-time flows, and results related to attractor–repeller pairs, Morse decompositions, connection and transition matrices, singular isolating neighborhoods, and computer assisted proofs are considered. Finally, we would like to mention some extensions and modifications of the Conley index for the continuous-time local flows:

- An improvement due to Conley in which the index is a connected simple system generated by all blocks (and more generally, by all index pairs) for an isolated invariant set S and connecting maps are naturally given by pushing along trajectories (compare [21]).
- A structure of the module over $\check{H}^*(X)$ for the cohomological Conley index, where X is the phase space, and its generalization to the equivariant case due to Floer in [30].
- An infinite-dimensional version given in [68], which applies to semilinear partial differential equations with the linear parts generated by sectorial operators having compact resolvents.
- Another infinite-dimensional version defined in [36] for flows generated by vector-fields of the form $L + K$ in a Hilbert space, where L is a bounded linear Fredholm operator and K is a completely continuous nonlinear operator. It particularly well fits to results on the existence of critical points in variational problems.
- Multivalued versions given in [51] and, in a simpler case of equations without uniqueness, in [44].
- The index over a base space defined in [52] which provides a better recognition of isolated invariant sets than the index h in the case of noncontractible phase space. In particular, it is nontrivial for the invariant part of the block considered in Example 9.5 if the knotted orbit is removed from the phase space.

References

- [1] F. Albrecht, *Remarques sur un theoreme de T. Ważewski relatif a l'allure asymptotique des intégrales des équations différentielles*, Bull. Acad. Polon. Sci. Cl. III **2** (1954), 315–318.
- [2] H. Amann, E. Zehnder, *Nontrivial solutions for a class of nonresonance problems and applications to nonlinear differential equations*, Ann. Scuola Norm. Sup. Pisa Cl. Sci. (4) **7** (4) (1980), 539–603.

- [3] J.P. Aubin, *Viability Theory*, Birkhäuser, Boston (1991).
- [4] J.P. Aubin, A. Cellina, *Differential Inclusions*, Springer-Verlag, Berlin (1984).
- [5] I. Barbălat, *Applications du principe topologique de T. Ważewski aux équations différentielles du second ordre*, Ann. Polon. Math. **5** (1958/1959), 303–317.
- [6] J. Bebernes, *Positive invariance and a Ważewski theorem*, Ordinary and Partial Differential Equations (Proc. Conf., Univ. Dundee, Dundee, 1974), Lecture Notes in Math., Vol. 415, Springer, Berlin (1974), 35–39.
- [7] J.W. Bebernes, W. Kelley, *Some boundary value problems for generalized differential equations*, SIAM J. Appl. Math. **25** (1973), 16–23.
- [8] J.W. Bebernes, J.D. Schuur, *The Ważewski topological method for contingent equations*, Ann. Mat. Pura Appl. (4) **87** (1970), 271–279.
- [9] J.W. Bebernes, J.D. Schuur, *Investigations in the topological method of Ważewski*, Atti Accad. Naz. Lincei Rend. Cl. Sci. Fis. Mat. Natur. (8) **49** (1970), 39–42.
- [10] M. Bertolino, *Framing and the asymptotic solutions of a first order differential equation*, Mat. Vesnik **2** (17) (1965), 223–231.
- [11] A. Bielecki, *Remarques sur la méthode de T. Ważewski dans l'étude qualitative des équations différentielles ordinaires*, Bull. Acad. Polon. Sci. Cl. III **4** (1956), 493–495.
- [12] A. Bielecki, *Extension de la méthode du rétracte de T. Ważewski aux équations au paratingent*, Ann. Univ. Mariae Curie-Skłodowska Sect. A. **9** (1955), 37–61.
- [13] K. Borsuk, *Sur les rétractes*, Fund. Math. **17** (1931), 171–209.
- [14] K. Borsuk, *Theory of Retracts*, Monografie Matematyczne, Vol. 44, PWN—Polish Scientific Publishers, Warszawa (1967).
- [15] K. Borsuk, *Theory of Shape*, Monografie Matematyczne, Vol. 59, PWN—Polish Scientific Publishers, Warszawa (1975).
- [16] K. Borsuk, *On the Lusternik–Schnirelmann category in the theory of shape*, Fund. Math. **99** (1) (1978), 35–42.
- [17] G. Bredon, *Topology and Geometry*, Springer-Verlag, New York (1993).
- [18] R.C. Churchill, *Isolated invariant sets in compact metric spaces*, J. Differential Equations **12** (1972), 330–352.
- [19] C. Conley, *On a generalization of the Morse index*, Ordinary Differential Equations (Proc. Conf., Math. Res. Center, Naval Res. Lab., Washington, DC, 1971), L. Weiss, ed., Academic Press, New York (1972), 27–33.
- [20] C. Conley, *A new statement of Ważewski theorem and an example*, Ordinary and Partial Differential Equations (Proc. Fourth Conf., Univ. Dundee, Dundee, 1976), W. Everitt, ed., Lecture Notes in Math., Vol. 564, Springer-Verlag, Berlin (1976), 61–71.
- [21] C. Conley, *Isolated Invariant Sets and the Morse Index*, CBMS Regional Conference Series in Mathematics, Vol. 38, Amer. Math. Soc., Providence, RI (1978).
- [22] C. Conley, R. Easton, *Isolated invariant sets and isolating blocks*, Trans. Amer. Math. Soc. **158** (1971), 35–61.
- [23] C.C. Conley, E. Zehnder, *The Birkhoff–Lewis fixed point theorem and a conjecture of V.I. Arnold*, Invent. Math. **73** (1983), 33–49.
- [24] J. Diblík, *On the question of the applicability of Ważewski's topological method*, Soviet Math. Dokl. **31** (2) (1985), 314–317.
- [25] J. Diblík, *On existence of δ -bounded solutions of a nonhomogeneous linear system of differential equations*, Funkcjnalaj Ekvacioj **34** (1991), 1–18.
- [26] J. Diblík, *The singular Cauchy–Nicoletti problem for the system of two ordinary differential equations*, Math. Bohem. **117** (1) (1992), 55–67.
- [27] J. Diblík, *Asymptotic behaviour of solutions of linear differential equations with delay*, Ann. Polon. Math. **58** (2) (1993), 131–137.
- [28] A. Dold, *Lectures on Algebraic Topology*, Springer-Verlag, Berlin (1980).
- [29] R. Easton, *Isolating blocks and symbolic dynamics*, J. Differential Equations **17** (1975), 96–118.
- [30] A. Floer, *A refinement of the Conley index and an application to the stability of hyperbolic invariant set*, Ergodic Theory Dynamical Systems **7** (1987), 93–103.

- [31] G. Fournier, D. Lupo, M. Ramos, M. Willem, *Limit relative category and critical point theory*, Dynamics Reported. Expositions in Dynamical Systems, New Series, Vol. 3, C.K.R.T. Jones, U. Kirchgraber, H.-O. Walther, eds., Springer-Verlag, Berlin (1994), 1–24.
- [32] A. Granas, J. Dugundji, *Fixed Point Theory, Vol. 1*, Monografie Matematyczne, Vol. 61, PWN—Polish Scientific Publishers, Warszawa (1982).
- [33] L. Górniewicz, *Homological methods in fixed-point theory of multi-valued maps*, Dissertationes Math. (Rozprawy Mat.) **129** (1976), 1–71.
- [34] D.H. Gottlieb, *A De Moivre like formula for fixed point theory*, Contemp. Math. **72** (1988), 99–105.
- [35] G. Gabor, M. Quincampoix, *On existence of solutions to differential equations or inclusions remaining in a prescribed closed subset of a finite-dimensional space*, J. Differential Equations **185** (2002), 483–512.
- [36] K. Gęba, M. Izydorek, A. Pruszek, *The Conley index in Hilbert spaces and its applications*, Stud. Math. **134** (3) (1999), 217–233.
- [37] P. Hartman, *Invariant sets and on a theorem of Ważewski*, Proc. Amer. Math. Soc. **32** (1972), 511–520.
- [38] H.M. Hastings, *A higher-dimensional Poincaré–Bendixson theorem*, Glas. Mat. Ser. III **14** (34) (2) (1979), 263–268.
- [39] A.F. Izé, *Asymptotic behavior and existence of periodic solutions of a class of non linear ordinary differential equations of the second order*, An. Acad. Brasil. Cienc. **41** (1969), 297–302.
- [40] L.K. Jackson, G. Klaasen, *A variation of the topological method of Ważewski*, SIAM J. Appl. Math. **20** (1971), 124–130.
- [41] J. Kalas, J. Osicka, *Bounded solutions of dynamical systems in the plane under the conditions of instability*, Math. Nachr. **170** (1994), 133–147.
- [42] J.L. Kaplan, A. Lasota, J.A. Yorke, *An application of the Ważewski retract method to boundary value problems*, Zeszyty Nauk. Univ. Jagiello. Prace Mat. **16** (1974), 7–14.
- [43] C. Kluczny, *Sur certaines familles de courbes en relation avec la théorie des équations différentielles ordinaires, I, II*, Ann. Univ. Mariae Curie-Skłodowska Sect. A **15** (1961) 13–40, **16** (1962) 5–18.
- [44] M. Kunze, T. Küpper, Y. Li, *On Conley index theory for non-smooth dynamical systems*, Differential Integral Equations **13** (4–6) (2000), 479–502.
- [45] V. Lakshmikantham, N. Onuchic, *On the comparison between the solutions of ordinary differential systems*, Bol. Soc. Mat. Sao Paulo **15** (1960) 25–34.
- [46] L. Malaguti, V. Taddei, *Asymptotic properties of an ordinary differential equation via topological methods*, Atti Sem. Mat. Fis. Univ. Modena **46** (2) (1998), 479–497.
- [47] R. McGehee, *Charles C. Conley, 1933–1984*, Ergodic Theory Dynamical Systems **8*** (Charles Conley Memorial Issue) (1988), 1–7.
- [48] Z. Mikołajska, *Sur une propriété asymptotique des intégrales d’une équation différentielle du second ordre*, Bull. Acad. Polon. Sci. Cl. III **2** (1954), 113–116.
- [49] Z. Mikołajska, *Une remarque sur les solutions bornées d’une équation différentielle non linéaire*, Ann. Polon. Math. **15** (1964), 23–32.
- [50] K. Mischaikow, M. Mrozek, *Conley index*, Handbook of Dynamical Systems, Vol. 2, B. Fiedler, ed., Elsevier, Amsterdam (2002), 393–460.
- [51] M. Mrozek, *A cohomological index of Conley type for multi-valued admissible flows*, J. Differential Equations **84** (1) (1990), 15–51.
- [52] M. Mrozek, J.F. Reineck, R. Szrednicki, *The Conley index over a base*, Trans. Amer. Math. Soc. **352** (9) (2000), 4171–4194.
- [53] C. Olech, *On the asymptotic behaviour of the solutions of a system of ordinary non-linear differential equations*, Bull. Acad. Polon. Sci. Cl. III **4** (1956), 555–561.
- [54] C. Olech, J. Szarski, Z. Szymdt, *Tadeusz Ważewski (1896–1972)*, Ann. Polon. Math. **29** (1974), 1–13.
- [55] N. Onuchic, *Applications of the topological method of Ważewski to certain problems of asymptotic behavior in ordinary differential equations*, Pacific J. Math. **11** (1961), 1511–1527.
- [56] N. Onuchic, *Relationships among the solutions of two systems of ordinary differential equations*, Michigan Math. J. **10** (1963), 129–139.
- [57] N. Onuchic, *On the asymptotic behavior of the solutions of functional-differential equations*, Differential Equations and Dynamical Systems (Proc. Internat. Sympos., Mayaguez, PR, 1965), J.K. Hale, J.P. LaSalle, eds., Academic Press, New York (1967), 223–233.

- [58] A. Pelczar, *On some extensions of the retract theorem of T. Ważewski*, Bull. Acad. Polon. Sci. Ser. Sci. Math. Astronom. Phys. **17** (1969), 693–698.
- [59] A. Pelczar, *Some generalizations of the retract theorem of T. Ważewski with applications to ordinary and partial differential equations of the first order*, Ann. Polon. Math. **29** (1974), 15–59.
- [60] A. Pelczar, *A local version of the generalized retract theorem of Ważewski with applications in the theory of partial differential equations of first order*, Ann. Polon. Math. **36** (1) (1979), 11–28.
- [61] A. Pelczar, *Some qualitative problems in the theory of second order partial differential equations*, Ann. Polon. Math. **52** (1) (1990), 1–17.
- [62] A. Pliś, *On a topological method for studying the behaviour of the integrals of ordinary differential equations*, Bull. Acad. Polon. Sci. Cl. III **2** (1954), 415–418.
- [63] M. Poźniak, *Lusternik–Schnirelmann category of an isolated invariant set*, Univ. Iagel. Acta Math. **31** (1994), 129–139.
- [64] C.C. Pugh, *A generalized Poincaré index formula*, Topology **7** (1968), 217–226.
- [65] R. Reissig, G. Sansone, R. Conti, *Qualitative Theorie nichtlinearer Differentialgleichungen*, Edizioni Cremonese, Rome (1963).
- [66] J. Radzikowski, *Proprietes asymptotiques des solutions d'un systeme de deux équations différentielles lineaires homogenes du premier ordre*, Demonstratio Math. **11** (1) (1978), 83–103.
- [67] K.P. Rybakowski, *Ważewski principle for retarded functional differential equations*, J. Differential Equations **36** (1980), 117–138.
- [68] K.P. Rybakowski, *The Homotopy Index and Partial Differential Equations*, Springer-Verlag, Berlin–Heidelberg (1987).
- [69] J.D. Schuur, *The asymptotic behavior of a solution of the third order linear differential equation*, Proc. Amer. Math. Soc. **18** (1967), 391–393.
- [70] J. Smoller, *Shock waves and reaction-diffusion equations*, Springer-Verlag, New York–Berlin (1983).
- [71] E.H. Spanier, *Algebraic Topology*, McGraw–Hill, New York–Toronto–London (1966).
- [72] R. Srzednicki, *On rest points of dynamical systems*, Fund. Math. **126** (1) (1985), 69–81.
- [73] R. Srzednicki, *Periodic and constant solutions via topological principle of Ważewski*, Univ. Iagel. Acta Math. **26** (1987), 183–190.
- [74] R. Srzednicki, *Periodic and bounded solutions in blocks for time-periodic nonautonomous ordinary differential equations*, Nonlinear Anal. **22** (6) (1994), 707–737.
- [75] R. Srzednicki, *On geometric detection of periodic solutions and chaos*, Non-linear Analysis and Boundary Value Problems for Ordinary Differential Equations (Udine), F. Zanolin, ed., CISM Courses and Lectures, Vol. 371, Springer, Vienna (1996), 197–209.
- [76] R. Srzednicki, *On solutions of two-point boundary value problems inside isolating segments*, Topol. Methods Nonlinear Anal. **13** (1) (1999), 73–89.
- [77] R. Srzednicki, *On cohomology of the invariant part of an isolating block*, Topol. Methods Nonlinear Anal. **14** (2) (1999), 257–260.
- [78] R. Srzednicki, *On periodic solutions inside isolating chains*, J. Differential Equations **165** (1) (2000), 42–60.
- [79] R. Srzednicki, K. Wójcik, *A geometric method for detecting chaotic dynamics*, J. Differential Equations **135** (1) (1997), 66–82.
- [80] Z. Svoboda, *Asymptotic behaviour of solutions of a delayed differential equation*, Demonstratio Math. **28** (1) (1995), 9–18.
- [81] Z. Szymdytówna, *Sur l'allure asymptotique des intégrales des équations différentielles ordinaires*, Ann. Soc. Polon. Math. **24** (2) (1951), 17–34.
- [82] Z. Szymdyt, *Sur l'allure asymptotique des intégrales de certains systemes d'équations différentielles non lineaires*, Ann. Polon. Math. **1** (1955), 253–276.
- [83] K. Tatariewicz, *Quelques exemples de l'allure asymptotique des solutions d'équations différentielles*, Ann. Univ. Mariae Curie-Skłodowska Sect. A **8** (1954), 105–133.
- [84] B. Vrdoljak, *New possibilities for the application of the retraction method in the qualitative analysis of differential equations*, Mat. Vesnik **10** (25) (1973), 45–58.
- [85] T. Ważewski, *Sur un principe topologique de l'examen de l'allure asymptotique des intégrales des équations différentielles ordinaires*, Ann. Soc. Polon. Math. **20** (1947), 279–313.
- [86] T. Ważewski, *Une méthode topologique de l'examen du phénomène asymptotique relativement aux équations différentielles ordinaires*, Atti Accad. Naz. Lincei. Rend. Cl. Sci. Fis. Mat. Nat. (8) **3** (1947), 210–215.

- [87] T. Ważewski, *Sur les intégrales asymptotiques des équations différentielles ordinaires*, Soc. Sci. Lett. Varsovie. C. R. Cl. III Sci. Math. Phys. **40** (1947), 38–42.
- [88] T. Ważewski, *Sur certaines conditions de coïncidence asymptotique des intégrales des deux systèmes d'équations différentielles*, Soc. Sci. Lett. Varsovie. C. R. Cl. III Sci. Math. Phys. **42** (1949), 198–203.
- [89] T. Ważewski, *Sur une méthode topologique de l'examen de l'allure asymptotique des intégrales des équations différentielles*, Proceedings of the International Congress of Mathematicians 1954, Amsterdam, Vol. III, North-Holland, Amsterdam (1956), 132–139.
- [90] F.W. Wilson, J.A. Yorke, *Lyapunov functions and isolating blocks*, J. Differential Equations **13** (1973), 106–123.
- [91] K. Wójcik, *Isolating segments and symbolic dynamics*, Nonlinear Anal. **33** (6) (1998), 575–591.
- [92] K. Wójcik, *On some nonautonomous chaotic system on the plane*, Internat. J. Bifur. Chaos Appl. Sci. Engrg. **9** (9) (1999), 1853–1858.
- [93] K. Wójcik, *On detecting periodic solutions and chaos in the time-periodically forced ODEs*, Nonlinear Anal. **45** (1) (2001), 19–27.
- [94] K. Wójcik, P. Zgliczyński, *On existence of infinitely many homoclinic solutions*, Monatsh. Math. **130** (2) (2000), 155–160.
- [95] K. Wójcik, P. Zgliczyński, *Isolating segments, fixed point index, and symbolic dynamics*, J. Differential Equations **161** (2) (2000), 245–288.
- [96] K. Wójcik, P. Zgliczyński, *Isolating segments, fixed point index, and symbolic dynamics, II: Homoclinic solutions*, J. Differential Equations **172** (1) (2001), 189–211.
- [97] K. Wójcik, P. Zgliczyński, *Isolating segments, fixed point index, and symbolic dynamics, III: Applications*, J. Differential Equations **183** (1) (2002), 262–278.

Author Index

Roman numbers refer to pages on which the author (or his/her work) is mentioned. Italic numbers refer to reference pages. Numbers between brackets are the reference numbers. No distinction is made between first and co-author(s).

- Adje, A. 93, *157* [1]
Agarwal, R.P. 3, *67* [1]; *67* [2]; *67* [3]; *67* [4];
67 [5]; *67* [6]; 327, 338, *349* [1]; *349* [2];
349 [3]; *349* [4]; *357* [218]; *357* [219]
Ahlbrandt, C.D. 338, *349* [5]; *349* [6]
Akô, K. 93, *157* [2]; *157* [3]
Albrecht, F. 599, *680* [1]
Alessio, F. 585 [1]
Alexander, J.C. 404, *431* [1]
Allegretto, W. 333, *349* [7]; *349* [8]; *349* [9];
349 [10]; 364, *431* [2]
Al'mukhamedov, M.I. 481, 528 [1]
Alonso, I.P. 409, *431* [6]
Alonso, J.M. 551, 585 [2]
Amann, H. 71, 102, 114, 115, 133, 139, 155,
157 [4]; *157* [5]; *157* [6]; *157* [7]; *157* [8]; 364,
431 [3]; 651, 676, *680* [2]
Ambrosetti, A. 115, *157* [8]; 547, 576, 585 [3];
585 [4]
Amine, Z. 585 [5]
Anane, A. 331, 332, 334–336, *349* [11]; *349* [12];
350 [13]; 365, 370, *431* [4]
Andrade, R.F.S. 439, 528 [2]
Andres, J. *350* [14]
Andronov, A.A. 540, 541, 585 [6]
Ángel Cid, J. 93, *157* [22]
Aris, R. 3, *67* [7]
Arnold, V. 515, 528 [3]
Atkinson, F.V. *350* [15]
Aubin, J.P. 615, *681* [3]; *681* [4]
Aubin, T. 405, *431* [5]
Aubry, S. 574, 585 [7]
Aynlar, B. 322, *350* [16]
Azorero, J.G. 409, *431* [6]
- Babkin, B.N. 155, *157* [9]
Badiale, M. 363, *431* [7]; 576, 585 [3]
- Balibrea, F. 481, 528 [4]
Bamon, R. 480, 528 [5]
Bandle, C. 363, 405, 412, *431* [8]; *431* [9];
431 [10]
Bangert, V. 585 [8]
Barbālat, I. 662, *681* [5]
Bartsch, T. 134, *157* [10]
Bates, P.W. 552, 585 [9]
Bautin, N.N. 452, 528 [6]
Baxley, J.V. 3, *67* [8]
Bebernes, J.W. 405, 406, 409, *431* [11]; 615, 662,
681 [6]; *681* [7]; *681* [8]; *681* [9]
Belley, J.M. 583, 585 [10]; 585 [11]; 585 [12];
585 [13]
Bellman, R. *350* [17]
ben Naoum, A. 401, *431* [12]
Bennewitz, Ch. 334, *350* [18]
Berger, M.S. 364, *431* [13]
Bernstein, S. 93, *157* [11]
Bertolino, M. 659, *681* [10]
Besicovitch, A.S. *350* [19]; 583, 585 [14]
Bhattacharya, T. 370, *431* [14]
Bielecki, A. 599, 604, 614, *681* [11]; *681* [12]
Bihari, I. *350* [20]; *350* [21]; *350* [22]; *350* [23]
Binding, P.A. *350* [24]
Birkhoff, G.D. 562, 573, 585 [15]; 585 [16]
Blot, J. 580, 584, 585 [17]; 585 [18]; 585 [19];
585 [20]
Bobisud, L.E. 3, *67* [9]; *67* [10]
Bognár, G. 337, *350* [25]; *350* [26]; *350* [27];
350 [28]
Bohner, M. 349, *350* [29]; *350* [30]
Bohr, H. *350* [31]
Bongsoo Ko 115, *159* [65]
Borsuk, K. 594, 629, 630, 642, 648, 649, *681* [13];
681 [14]; *681* [15]; *681* [16]
Borůvka, O. *350* [32]

- Bosetto, E. 575, 576, 585 [21]; 585 [22]; 585 [23]
 Bott, R. 564, 585 [24]
 Bountis, T.C. 439, 528 [7]
 Bratu, G. 362, 431 [15]
 Bredon, G. 610, 624, 681 [17]
 Brenig, L. 528 [8]
 Brezis, H. 110, 134, 157 [12]; 157 [13]; 418, 425, 431 [16]
- Cabada, A. 156, 157 [14]; 157 [15]
 Cairó, L. 439, 448, 452, 486, 491, 492, 503–505, 509–511, 528 [9]; 528 [10]; 528 [11]
 Calanchi, M. 560, 585 [1]; 585 [25]; 585 [26]
 Callegari, A. 3, 67 [11]; 67 [12]
 Calvert, J.E. 3, 67 [10]
 Campillo, A. 454, 528 [12]
 Campos, J. 557, 585 [27]
 Cañada, A. 537, 586 [28]; 586 [29]; 586 [30]; 586 [31]
 Cantrijn, F. 439, 528 [13]
 Carleman, T. 439, 528 [14]
 Carnicer, M.M. 454, 528 [12]; 528 [15]
 Castro, A. 364, 381, 388, 431 [17]; 431 [18]; 431 [19]; 536, 551, 586 [32]
 Cecchi, M. 322, 326, 327, 350 [33]; 350 [34]; 350 [35]; 350 [36]; 350 [37]; 350 [38]; 350 [39]; 350 [40]; 350 [41]
 Cellina, A. 615, 681 [4]
 Čepička, J. 558, 586 [33]
 Cerveau, D. 454, 528 [16]
 Chandrasekhar, S. 362, 405, 407, 431 [20]
 Chang, K.C. 71, 134, 157 [17]; 157 [18]; 157 [19]; 549, 586 [34]
 Chantladze, T. 351 [42]
 Chanturia, T.A. 326, 351 [43]; 351 [44]; 354 [127]
 Chaplygin, S.A. 155, 157 [16]
 Charkone, O. 334, 349 [12]
 Chavarriga, J. 439, 446, 448, 461, 470, 475, 487, 501, 515, 517, 528 [17]; 529 [18]; 529 [19]; 529 [20]; 529 [21]; 529 [22]; 529 [23]; 529 [24]; 529 [25]; 529 [26]
 Chen, Sh. 351 [45]
 Chenciner, A. 586 [35]
 Cheng, S.S. 355 [157]; 355 [158]; 357 [227]
 Cherpion, M. 155, 156, 157 [20]; 157 [21]
 Chow, S.N. 369, 431 [21]
 Christopher, C.J. 439, 446, 448, 455, 457, 478, 485, 487, 491, 492, 500, 502, 503, 510, 529 [27]; 529 [28]; 529 [29]; 529 [30]; 529 [31]; 529 [32]; 529 [33]; 529 [34]; 529 [35]; 530 [61]; 531 [84]
 Churchill, R.C. 600, 643, 644, 669, 681 [18]
 Cieutat, P. 580, 585 [19]
- Clément, P. 362, 380, 409, 410, 418, 419, 431 [22]; 431 [23]
 Coffman, C.V. 363, 425, 431 [9]; 431 [24]; 431 [25]
 Coles, W.J. 351 [46]
 Collatz, L. 156, 157 [23]
 Conley, C.C. 599, 600, 606, 608, 651, 673, 678–680, 681 [19]; 681 [20]; 681 [21]; 681 [22]; 681 [23]
 Conti, M. 134, 157 [24]
 Conti, R. 659, 683 [65]
 Coppel, W.A. 489, 529 [36]
 Courant, R. 155, 157 [25]
 Cozma, D. 487, 529 [37]
 Crandall, M.G. 409, 432 [26]
 Cuesta, M. 334, 351 [47]; 351 [48]
- Damascelli, L. 428, 432 [27]; 432 [28]
 Dancer, E.N. 134, 157 [26]; 536, 544, 546, 557, 559, 585 [27]; 586 [36]; 586 [37]
 Dang, H. 363, 364, 371, 379, 391, 393, 400, 401, 432 [29]; 432 [30]; 432 [31]
 Darboux, G. 439, 448, 460, 466, 515, 529 [38]
 De Coster, C. 72, 80, 90, 91, 93, 94, 101, 115, 155, 156, 157 [20]; 157 [21]; 157 [27]; 157 [28]; 157 [29]; 158 [30]; 158 [31]; 158 [32]; 158 [33]; 158 [34]; 158 [35]; 158 [36]; 401, 431 [12]
 de Figueiredo, D.G. 71, 133, 134, 158 [37]; 158 [38]; 334, 351 [47]; 351 [48]; 362, 409, 410, 418, 419, 431 [22]
 de Thélin, F. 316, 353 [101]; 381, 432 [37]
 de Vallée Poussin, Ch. 357 [214]
 Debnath, L. 322, 354 [144]
 Deimling, K. 13, 67 [13]; 364, 369, 432 [32]
 Del Pino, M.A. 313, 316–320, 351 [49]; 351 [50]; 351 [51]; 351 [52]; 351 [53]; 365, 369–371, 400, 432 [33]; 432 [34]
 Delanoë, P. 363, 432 [35]
 Denzler, J. 566, 567, 586 [38]
 Díaz, J.I. 351 [54]
 Diblík, J. 618, 659, 662, 681 [24]; 681 [25]; 681 [26]; 681 [27]
 Ding, T. 119, 158 [39]; 478, 532 [105]
 Dold, A. 610, 630, 632, 634, 635, 647, 681 [28]
 Donati, F. 554, 558, 560, 586 [40]; 586 [41]
 Dong Zhenxi 478, 532 [105]
 Dorizzi, B. 439, 528 [7]
 Došlá, Z. 322, 326, 327, 350 [33]; 350 [34]; 350 [35]; 350 [36]; 350 [37]
 Došlý, O. 334, 337, 342, 345, 350 [28]; 351 [55]; 351 [56]; 351 [57]; 351 [58]; 351 [59]; 351 [60]; 351 [61]; 351 [62]; 351 [63];

- 351 [64]; 351 [65]; 351 [66]; 351 [67];
 351 [68]; 352 [69]; 352 [70]; 352 [71]; 352 [72]
 Drábek, P. 313–318, 321, 323, 334, 350 [24];
 351 [49]; 352 [73]; 352 [74]; 352 [75]; 352 [76];
 352 [77]; 352 [78]; 352 [79]; 352 [80];
 352 [81]; 352 [82]; 365, 432 [36]; 558, 586 [33]
 Du, Y. 134, 157 [26]
 Dugundji, J. 638, 682 [32]
 Dunninger, D.R. 333, 352 [83]
- Easton, R. 600, 667, 681 [22]; 681 [29]
 Eberhard, W. 352 [84]
 Eberly, D. 405, 406, 409, 431 [11]
 Écalle, J. 480, 517, 529 [39]
 el Hachimi, A. 381, 432 [37]
 Elbert, A. 350 [15]; 351 [65]; 351 [66]; 352 [84];
 352 [85]; 352 [86]; 352 [87]; 352 [88]; 352 [89];
 352 [90]; 352 [91]; 352 [92]; 352 [93]; 353 [94]
 Elgueta, M. 313, 316, 319, 320, 351 [51];
 351 [52]; 400, 432 [33]
 Eloë, P.W. 3, 67 [14]
 Emden, R. 353 [95]
 Emden, V. 405, 407, 432 [38]
 Epheser, H. 93, 158 [40]
 Erbe, L.H. 349, 351 [45]; 353 [96]; 353 [97]; 401,
 432 [39]
 Evdokimenco, R.M. 475, 529 [40]; 529 [41];
 529 [42]
 Evtuchov, V.M. 353 [98]
- Fabry, C. 93, 158 [41]
 Fan, X. 353 [99]
 Feix, M.R. 439, 448, 452, 486, 491, 509, 528 [9]
 Filiptsov, V.F. 475, 529 [43]
 Fink, A.M. 582, 583, 586 [43]; 586 [44]
 Fleckinger, J. 316, 353 [100]; 353 [101]
 Floer, A. 645, 647, 680, 681 [30]
 Fonda, A. 562, 563, 565, 586 [45]; 586 [46]
 Forni, G. 587 [73]
 Fournier, G. 544, 579, 583, 584, 585 [10];
 585 [11]; 585 [12]; 586 [47]; 586 [48];
 630–633, 682 [31]
 Fowler, R.H. 353 [102]
 Frank-Kamenetskii, D.A. 362, 405, 407, 432 [40]
 Friedlander, L. 370, 432 [41]
 Frommer, M. 453, 529 [44]
 Fučík, S. 314, 332, 353 [103]; 536, 586 [49]
 Fulton, W. 462, 530 [45]
 Furta, S.D. 456, 474, 492, 530 [46]
- García Azorero, J. 362, 370, 409, 425, 432 [43];
 432 [44]
 García-Huidobro, M. 363–365, 371, 379–381,
 383, 385, 387, 431 [23]; 432 [45]; 432 [46];
 432 [47]; 432 [48]
 Gatica, J.A. 3, 68 [15]
 Gaudenzi, M. 115, 158 [42]
 Gėba, K. 680, 682 [36]
 Gelfand, I.M. 362, 405, 407, 432 [49]
 Gendzhoyan, G.V. 156, 158 [43]
 Ghoussoub, N. 547, 586 [51]
 Giacomini, H.J. 439, 446, 475, 482, 487, 492, 501,
 503–505, 510, 511, 515, 517, 528 [10];
 529 [18]; 529 [19]; 529 [20]; 529 [21];
 530 [47]; 530 [48]; 530 [49]; 530 [50]; 530 [51]
 Gidas, B. 361, 362, 425, 428, 432 [50]
 Giné, J. 439, 487, 501, 515, 517, 529 [18];
 529 [19]; 529 [20]
 Girg, P. 313, 352 [76]; 352 [77]; 537, 586 [52]
 Goriely, A. 505, 528 [8]; 530 [52]
 Górniewicz, L. 615, 629, 682 [33]
 Gossez, J.-P. 101, 115, 158 [44]; 158 [45]; 334,
 349 [12]; 351 [47]; 351 [48]; 353 [100]
 Gottlieb, D.H. 652, 682 [34]
 Grace, S.R. 349 [2]; 349 [3]
 Grammaticos, B. 439, 505, 528 [7]; 530 [53]
 Granas, A. 638, 682 [32]
 Grossinho, M.R. 93, 115, 157 [29]; 353 [104]
 Gudkov, V.V. 93, 158 [46]
 Guillou, L. 554, 586 [53]
 Gustafson, G.B. 393, 396, 432 [51]
 Gustafson, K. 405, 432 [52]
 Gutierrez, C. 530 [54]
- Habets, P. 3, 4, 68 [16]; 72, 80, 90, 91, 93, 94, 101,
 115, 134, 155, 156, 157 [14]; 157 [20];
 157 [21]; 157 [29]; 158 [30]; 158 [31];
 158 [32]; 158 [33]; 158 [41]; 158 [42]; 158 [47];
 158 [48]; 158 [49]; 158 [50]; 158 [51];
 158 [52]; 158 [53]; 159 [54]; 537, 586 [54]
 Hai, D. 363, 388, 433 [53]; 433 [54]
 Hai Huang 570, 573, 584, 587 [56]; 587 [57];
 587 [58]; 587 [59]
 Hale, J.K. 369, 431 [21]
 Hamel, G. 535, 546, 586 [55]
 Hardy, G.H. 353 [105]
 Hartman, P. 353 [106]; 368, 433 [55]; 616, 617,
 682 [37]
 Hasselblatt, B. 587 [62]
 Hastings, H.M. 642, 682 [38]
 Hatvani, L. 353 [107]; 353 [108]
 Hayes, J. 585 [10]
 Heinonen, J. 362, 433 [56]
 Henderson, J. 3, 67 [14]
- Gabor, G. 615, 616, 682 [35]
 Gaines, R.E. 543, 544, 586 [50]
 Gallouët, T. 409, 432 [42]

- Henrard, M. 115, 158 [34]
 Hernández, J. 316, 353 [101]
 Hess, P. 93, 159 [55]
 Hietarinta, J. 439, 480, 530 [55]
 Hilbert, D. 155, 157 [25]; 439, 530 [56]
 Hilger, S. 349, 353 [97]; 353 [109]
 Hille, E. 353 [110]
 Hinton, D.B. 349 [5]
 Hofer, H. 133, 134, 159 [56]; 159 [57]
 Hong, H.L. 353 [111]
 Hoshino, H. 353 [112]
 Huang, Ch. 353 [113]
 Huang, Q. 351 [45]
 Huang, Y.X. 333, 349 [9]; 349 [10]; 350 [24];
 353 [114]
 Huang Wenzao 478, 532 [105]
- Iannacci, R. 119, 158 [39]
 Ilyashenko, Yu. 480, 517, 530 [57]
 Imabayashi, R. 353 [112]
 Izé, A.F. 659, 682 [39]
 Izydorek, M. 680, 682 [36]
- Jackson, L.K. 93, 159 [58]; 615, 662, 682 [40]
 Jacobsen, J. 362, 409–411, 417, 433 [57];
 433 [58]; 433 [59]
 Jäger, W. 425, 433 [60]
 Jaroš, J. 333, 351 [67]; 353 [115]; 353 [116];
 353 [117]; 353 [118]
 Jenšiková, J. 558, 586 [33]
 Jianchu, J. 353 [119]
 Jiangong You 572, 589 [130]; 589 [131];
 589 [132]; 589 [133]; 589 [134]
 Jimenez, V. 481, 528 [4]
 Jingfa, W. 327, 353 [120]; 353 [121]
 Jingxian Sun 134, 159 [68]
 Joseph, D.D. 362, 433 [61]
 Jouanolou, J.P. 439, 446, 461, 492, 530 [58]
- Kalas, J. 659, 682 [41]
 Kandelaki, N. 351 [42]; 354 [122]
 Kannan, R. 544, 557, 587 [60]; 587 [61]
 Kantorovich, L. 156, 159 [59]
 Kaper, H. 393, 400, 433 [62]
 Kaplan, J.L. 662, 682 [42]
 Kapteyn, W. 452, 530 [59]; 530 [60]
 Karsai, J. 354 [123]
 Katok, A. 587 [62]
 Katriel, G. 536, 587 [63]; 587 [64]
 Kazdan, J.L. 405, 433 [63]
 Kelley, J.L. 78, 159 [60]
 Kelley, W.G. 338, 354 [124]; 615, 662, 681 [7]
 Khaikin, S.E. 540, 541, 585 [6]
- Kiguradze, I.T. 93, 159 [61]; 159 [62]; 159 [63];
 354 [125]; 354 [126]; 354 [127]; 354 [128]
 Kipeläinen, T. 362, 433 [56]
 Kiomura, J. 354 [129]
 Kitano, M. 322, 354 [132]
 Klaasen, G. 615, 662, 682 [40]
 Kluczny, C. 615, 682 [43]
 Knaap, M. 393, 400, 433 [62]
 Knobloch, H.W. 93, 159 [64]
 Kolesov, Y.S. 115, 159 [66]
 Kong, Q. 354 [130]
 Kooij, R. 491, 492, 530 [61]
 Krasnosel'skii, M. 369, 396, 433 [64]; 433 [65]
 Kufner, A. 354 [131]
 Kunze, M. 680, 682 [44]
 Küpper, T. 680, 682 [44]
 Kurepa, A. 381, 431 [17]; 431 [18]
 Kusano, T. 322, 327, 333, 334, 352 [90]; 352 [91];
 352 [92]; 352 [93]; 353 [112]; 353 [115];
 353 [116]; 353 [117]; 353 [118]; 354 [129];
 354 [132]; 354 [133]; 354 [134]; 354 [135];
 354 [136]; 354 [137]; 354 [138]; 354 [139];
 354 [140]; 354 [141]; 354 [142]
 Kvinikadze, G. 326, 354 [128]; 354 [143]
 Kwong, M. 393, 400, 433 [62]
- Lakshmikantham, V. 3, 67 [4]; 67 [5]; 659,
 682 [45]
 Laloy, M. 93, 158 [47]
 Landesman, E.M. 321, 354 [145]
 Lasota, A. 662, 682 [42]
 Lax, P.D. 439, 530 [62]
 Lazer, A.C. 321, 354 [145]
 Le, V. 391, 401, 433 [66]
 Le Daeron, P.Y. 574, 585 [7]
 Leela, S. 3, 67 [4]
 Leighton, W. 354 [146]; 354 [147]; 355 [148]
 Lepin, A.J. 93, 158 [46]
 Levi, M. 571, 572, 587 [65]; 587 [66]; 587 [67]
 Lewis, R.T. 349 [5]
 Li, H.J. 355 [149]; 355 [150]; 355 [151];
 355 [152]; 355 [153]; 355 [154]; 355 [155]
 Li, S.J. 134, 159 [67]
 Li, W.-T. 353 [99]; 355 [156]; 355 [157];
 355 [158]
 Li, Y. 680, 682 [44]
 Lian, W.Ch. 353 [111]
 Lin, S.S. 363, 425, 433 [67]; 433 [68]
 Lindqvist, P. 330, 331, 355 [159]; 355 [160];
 355 [161]; 365, 433 [69]
 Lins Neto, A. 454, 455, 528 [16]; 530 [65]
 Lions, P.L. 417, 433 [70]
 Liouville, J. 362, 433 [71]
 Littlewood, J.E. 353 [105]

- Llibre, J. 439, 446, 448, 452, 455–457, 461, 470, 475, 478, 480–482, 485–487, 491, 492, 500, 501, 503–505, 509–511, 515, 517, 518, 528, 528 [9]; 528 [10]; 528 [11]; 529 [19]; 529 [20]; 529 [21]; 529 [22]; 529 [23]; 529 [24]; 529 [25]; 529 [26]; 529 [30]; 529 [31]; 529 [32]; 529 [33]; 529 [34]; 529 [35]; 530 [47]; 530 [48]; 530 [49]; 530 [50]; 530 [54]; 530 [63]; 530 [64]; 530 [66]; 530 [67]; 530 [68]; 530 [69]; 530 [70]; 531 [71]
- Lloyd, N.G. 86, 159 [69]; 364, 433 [72]; 455, 531 [84]
- Lomtatidze, A. 351 [42]; 351 [68]; 352 [69]; 354 [122]; 355 [162]
- Lotka, A.J. 442, 504, 531 [72]
- Lundgren, T.S. 362, 433 [61]
- Luning, C.D. 3, 68 [17]
- Luo, J. 322, 354 [144]
- Lupo, D. 630–633, 682 [31]
- Maccallum, M.A.H. 455, 531 [73]
- Malaguti, L. 659, 682 [46]
- Manásevich, R.F. 313, 316–320, 323, 351 [49]; 351 [50]; 351 [51]; 351 [52]; 351 [53]; 352 [76]; 352 [78]; 355 [164]; 355 [165]; 355 [166]; 355 [167]; 355 [168]; 362–365, 369–371, 379–381, 383, 385, 387, 393, 395, 398–400, 431 [23]; 432 [29]; 432 [33]; 432 [34]; 432 [36]; 432 [45]; 432 [46]; 432 [47]; 432 [48]; 433 [73]; 433 [74]
- Mancini, G. 115, 157 [8]
- Manojlović, J.V. 355 [163]
- Marcus, M. 363, 431 [9]; 431 [25]
- Mařík, R. 334, 352 [70]; 355 [169]; 355 [170]; 355 [171]
- Marini, M. 322, 326, 327, 350 [33]; 350 [34]; 350 [35]; 350 [36]; 350 [37]; 350 [38]; 350 [39]; 350 [40]; 350 [41]; 355 [172]; 355 [173]; 355 [174]
- Markus, L. 517, 531 [74]
- Martinez-Amores, P. 554, 556, 565, 587 [68]
- Martio, O. 362, 433 [56]
- Mather, J.N. 566, 574, 587 [69]; 587 [70]; 587 [71]; 587 [72]; 587 [73]
- Matucci, S. 356 [179]
- Mawhin, J. 94, 159 [70]; 313, 355 [164]; 422, 433 [75]; 433 [76]; 536, 537, 543, 544, 547, 549, 551, 552, 554, 556, 563–566, 578–580, 584, 585 [19]; 586 [47]; 586 [50]; 587 [68]; 587 [74]; 587 [75]; 587 [76]; 587 [77]; 587 [78]; 587 [79]; 587 [80]; 587 [81]; 587 [82]; 588 [83]; 588 [84]; 588 [85]; 588 [86]
- McGehee, R. 602, 682 [47]
- McGough, J.S. 412, 413, 433 [77]
- Merizzi, L. 134, 157 [24]
- Mignot, F. 409, 432 [42]; 433 [78]; 433 [79]
- Mikolaĵska, Z. 621, 659, 682 [48]; 682 [49]
- Milloux, H. 355 [175]
- Mirzov, J.D. 322, 326, 355 [176]; 356 [177]; 356 [178]
- Mischaikow, K. 593, 667, 671, 680, 682 [50]
- Mitidieri, E. 362, 409, 410, 418, 419, 431 [22]
- Mizukami, M. 327, 356 [180]
- Mlak, W. 93, 159 [71]
- Morse, M. 355 [148]
- Moser, J. 566, 571, 572, 588 [87]; 588 [88]; 588 [89]; 588 [90]; 588 [91]; 588 [92]; 588 [93]; 588 [94]; 588 [95]
- Moulin Ollagnier, J. 446, 457, 461, 492, 503–505, 529 [24]; 530 [53]; 531 [75]; 531 [76]; 531 [77]; 531 [78]; 531 [79]
- Mrozek, M. 593, 667, 671, 680, 682 [50]; 682 [51]; 682 [52]
- Müller, M. 71, 159 [72]
- Nabana, E. 363, 431 [7]
- Nachman, A. 3, 67 [11]; 67 [12]
- Nagabuchi, Y. 356 [181]
- Nagasaki, K. 363, 409, 425, 427, 434 [80]; 434 [81]; 434 [82]
- Nagumo, M. 93, 159 [73]; 159 [74]
- Naito, M. 327, 352 [91]; 352 [92]; 354 [129]; 354 [133]; 354 [134]; 354 [137]; 356 [180]; 356 [182]
- Naito, Y. 334, 354 [135]; 354 [136]; 356 [182]
- Nečas, J. 314, 332, 353 [103]
- Nehari, Z. 428, 429, 434 [83]
- Nemytskii, V.V. 531 [80]
- Neuman, F. 356 [183]
- Neumann, D.A. 517, 531 [81]
- Nhashama, M.N. 3, 68 [18]
- Ni, W.M. 361, 362, 425, 428, 430, 432 [50]; 434 [84]
- Nicolau, M. 515, 517, 530 [63]
- Nirenberg, L. 134, 157 [13]; 361, 362, 418, 425, 428, 431 [16]; 432 [50]
- Nistri, P. 364, 431 [2]
- Njoku, F.I. 313, 355 [165]; 393, 433 [73]
- Nowicki, A. 446, 531 [79]
- Odani, K. 446, 531 [82]
- Offin, D. 563, 576, 588 [96]; 588 [97]
- Ogata, A. 334, 354 [136]
- Ohriska, J. 356 [184]
- Olech, C. 356 [185]; 602, 659, 682 [53]; 682 [54]
- Oliker, V. 3, 68 [15]
- Olver, P.J. 439, 531 [83]

- Omari, P. 93, 115, 134, 156, 158 [35]; 158 [45]; 158 [48]; 158 [49]; 159 [75]; 159 [76]; 353 [104]
- Onuchic, N. 621, 659, 682 [45]; 682 [55]; 682 [56]; 682 [57]
- Opial, Z. 356 [185]; 578, 588 [98]
- O'Regan, D. 3, 43, 48, 50, 67 [1]; 67 [2]; 67 [3]; 67 [4]; 67 [5]; 67 [6]; 68 [19]; 349 [3]
- Ortega, R. 544, 551, 552, 554, 556–561, 565, 566, 579, 584, 585 [5]; 585 [27]; 586 [37]; 587 [60]; 587 [61]; 587 [68]; 588 [99]; 588 [100]; 588 [101]; 588 [102]; 588 [103]; 588 [104]; 588 [105]; 588 [106]; 588 [107]; 588 [108]; 588 [109]
- Osicka, J. 659, 682 [41]
- Otaga, A. 327, 354 [138]; 354 [139]; 354 [140]
- Otani, M. 352 [79]; 356 [186]; 356 [187]
- Pacella, F. 428, 432 [27]; 432 [28]
- Pantazi, C. 491, 492, 529 [33]
- Parasyuk, I.O. 589 [135]
- Peano, G. 93, 159 [77]
- Pearson, J.M. 455, 531 [84]
- Peitgen, H.-O. 420, 434 [85]; 434 [86]; 434 [87]
- Pelczar, A. 599, 606, 659, 683 [58]; 683 [59]; 683 [60]; 683 [61]
- Peletier, L.A. 363, 430, 431 [10]; 434 [88]
- Peña, S. 356 [188]
- Pennequin, D. 584, 585 [20]
- Peral Alonso, I. 362, 370, 409, 425, 432 [43]; 432 [44]
- Percival, I.C. 589 [110]; 589 [111]
- Pereira, J.V. 439, 448, 502, 503, 510, 529 [34]; 531 [85]
- Pérez del Río, J.S. 491, 530 [66]
- Perron, O. 71, 93, 159 [78]
- Perry, W.L. 3, 68 [17]
- Persson, L.-E. 354 [131]
- Peterson, A.C. 338, 349, 349 [6]; 350 [29]; 350 [30]; 354 [124]
- Philos, Ch. 356 [189]
- Picard, E. 71, 93, 154, 155, 159 [79]; 159 [80]; 160 [81]; 160 [82]; 160 [83]; 160 [84]
- Picone, M. 356 [190]
- Piros, M. 356 [191]
- Pliš, A. 599, 606, 608, 683 [62]
- Pohozaev, S. 412, 429, 434 [89]
- Poincaré, H. 439, 454, 456, 531 [86]; 562, 589 [112]
- Pólya, G. 353 [105]
- Poppenberg, M. 428, 430, 434 [90]
- Pouso, R. 80, 94, 156, 157 [14]; 158 [50]
- Późniak, M. 636, 642, 683 [63]
- Preiss, D. 547, 586 [51]
- Prelle, M.J. 439, 501, 531 [87]
- Prodi, G. 94, 160 [86]
- Protter, M.H. 139, 155, 160 [85]
- Pruszek, A. 680, 682 [36]
- Pucci, P. 414–416, 419, 434 [91]; 434 [92]; 547, 589 [113]
- Puel, J.-P. 409, 431 [6]; 432 [42]; 433 [78]; 433 [79]
- Pugh, C.C. 652, 683 [64]
- Qin Yuan-Xun 475, 478, 531 [88]
- Quincampoix, M. 615, 616, 682 [35]
- Ráb, M. 356 [192]
- Rabinowitz, P.H. 369, 409, 420, 432 [26]; 434 [93]; 434 [94]; 547, 549, 574, 585 [4]; 589 [114]; 589 [115]
- Rabtsевич, V.A. 356 [193]
- Rachůnková, I. 115, 160 [87]
- Radzikowski, J. 659, 683 [66]
- Ramani, A. 439, 505, 528 [7]; 530 [53]
- Ramos, M. 630–633, 682 [31]
- Rao, M. 365, 434 [95]
- Rauh, A. 439, 528 [2]
- Řehák, P. 338, 340, 345, 349, 352 [71]; 356 [194]; 356 [195]; 356 [196]; 356 [197]; 356 [198]; 356 [199]; 356 [200]; 356 [201]
- Reichel, W. 356 [202]
- Reineck, J.F. 680, 682 [52]
- Reissig, R. 659, 683 [65]
- Ren, Z. 365, 434 [95]
- Repetto, C.E. 439, 530 [51]
- Řezníčková, J. 352 [72]
- Robinson, B. 313–315, 321, 334, 352 [80]; 352 [81]
- Roca, F. 537, 586 [52]
- Rockafeller, R.T. 356 [203]
- Rodríguez, G. 480, 481, 518, 530 [67]; 530 [68]; 530 [69]
- Rodríguez, J.A. 491, 530 [66]
- Rogovchenko, S.P. 322, 327, 356 [205]
- Rogovchenko, Y.V. 322, 327, 356 [204]; 356 [205]
- Rong Yuan 587 [59]
- Roselli, P. 537, 589 [116]
- Rosenblatt, A. 94, 160 [88]
- Rousseau, C. 486, 531 [89]
- Royalty, W.D. 3, 67 [10]
- Ruiz, D. 537, 586 [28]; 586 [29]
- Rybakowski, K.P. 621–625, 674, 680, 683 [67]; 683 [68]
- Saadi Drissi, K. 583, 585 [11]; 585 [12]
- Sagdeev, R.Z. 536, 589 [117]

- Saitō, Y. 334, 350 [18]
 Sanchez, L. 93, 156, 157 [15]; 158 [51]
 Sansone, G. 357 [206]; 659, 683 [65]
 Sarlet, W. 439, 528 [13]
 Satō, T. 93, 160 [89]; 160 [90]
 Sattinger, D.H. 115, 160 [91]; 405, 434 [96]
 Schaaf, R. 420, 422, 424, 434 [97]; 434 [98]; 537, 589 [118]
 Schecter, S. 481, 531 [90]
 Schlomiuk, D. 439, 453, 454, 486, 503, 530 [70]; 531 [89]; 531 [91]; 531 [92]; 531 [93]
 Schmitt, K. 93, 160 [92]; 362–365, 371, 379–381, 383, 385, 387, 388, 391, 393, 395, 396, 398–401, 410–413, 420, 422, 424, 425, 428, 430, 431 [23]; 432 [29]; 432 [30]; 432 [31]; 432 [39]; 432 [45]; 432 [46]; 432 [47]; 432 [51]; 433 [53]; 433 [54]; 433 [59]; 433 [60]; 433 [66]; 433 [74]; 433 [75]; 433 [76]; 434 [85]; 434 [86]; 434 [87]; 434 [90]; 434 [97]; 434 [98]; 434 [99]; 434 [100]; 434 [101]; 537, 589 [118]
 Schneider, A. 353 [94]
 Schröder, J. 156, 157 [23]; 160 [93]
 Schuur, J.D. 615, 659, 681 [8]; 681 [9]; 683 [69]
 Scorza Dragoni, G. 71, 92, 93, 160 [94]; 160 [95]; 160 [96]; 160 [97]
 Sedziwy, S. 313, 355 [166]
 Serra, E. 550, 552, 554, 556, 557, 565, 574–576, 585 [1]; 585 [21]; 585 [22]; 585 [23]; 585 [25]; 588 [107]; 589 [119]; 589 [120]; 589 [121]; 589 [122]
 Serrin, J. 414–416, 419, 428, 430, 434 [84]; 434 [88]; 434 [91]; 434 [92]; 434 [102]; 547, 589 [113]
 Shapiro, V.L. 370, 434 [103]
 Shekhter, B.L. 93, 159 [63]
 Shieh, S.L. 349 [4]
 Shivaji, R. 115, 160 [98]; 363, 364, 388, 391, 401, 431 [19]; 432 [31]; 433 [54]
 Shubé, A.S. 487, 531 [94]
 Silva, E.A.D.B. 409, 434 [104]
 Singer, M.F. 439, 481, 501–504, 531 [87]; 531 [90]; 531 [95]
 Smoller, J. 425, 434 [105]; 669, 673, 679, 680, 683 [70]
 Soares, S.H.M. 409, 434 [104]
 Solimini, S. 71, 133, 134, 158 [38]
 Sorolla, J. 475, 529 [25]
 Sotomayor, J. 439, 448, 515, 516, 529 [26]; 531 [96]
 Souček, J. 314, 332, 353 [103]
 Souček, V. 314, 332, 353 [103]
 Spanier, E.H. 627, 642, 683 [71]
 Srikanth, P.N. 427, 434 [106]
 Srzednicki, R. 637, 645, 652, 654–658, 662, 665–667, 669, 680, 682 [52]; 683 [72]; 683 [73]; 683 [74]; 683 [75]; 683 [76]; 683 [77]; 683 [78]; 683 [79]
 Stampacchia, G. 93, 160 [99]
 Stepanov, V.V. 531 [80]
 Strelcyn, J.M. 439, 446, 505, 530 [53]; 531 [79]; 531 [97]
 Struwe, M. 357 [207]
 Šubá, A. 487, 529 [37]
 Suzuki, T. 363, 409, 425, 427, 434 [80]; 434 [81]; 434 [82]; 435 [107]
 Sverdløve, R. 481, 531 [98]
 Svoboda, Z. 659, 683 [80]
 Swanson, C.A. 357 [208]
 Świrszcz, G. 478, 529 [35]
 Szarski, J. 71, 160 [100]; 602, 682 [54]
 Szmydt, Z. 602, 659, 682 [54]; 683 [82]
 Szmydtówna, Z. 659, 683 [81]
 Szulkin, A. 579, 584, 586 [48]
 Taddei, V. 659, 682 [46]
 Takáč, P. 313, 316, 352 [77]; 352 [82]; 353 [100]; 353 [101]; 355 [167]
 Talenti, G. 357 [209]
 Taliaferro, S. 3, 68 [20]
 Tanigawa, T. 327, 352 [93]; 353 [112]; 353 [117]; 354 [137]; 357 [210]
 Tarallo, M. 115, 158 [36]; 550, 552, 554, 556, 557, 560, 565, 574, 584, 585 [26]; 588 [107]; 588 [108]; 588 [109]; 589 [119]; 589 [120]; 589 [121]; 589 [122]
 Tarantello, G. 558, 589 [123]
 Tatarkiewicz, K. 659, 683 [83]
 Terracini, S. 134, 157 [24]; 554, 556, 565, 574, 576, 585 [22]; 585 [23]; 589 [121]; 589 [122]
 Thomas, L.H. 357 [211]
 Tineo, A. 3, 68 [21]; 577, 589 [124]
 Tipler, F.J. 357 [212]
 Tiriyaki, A. 322, 350 [16]
 Torres, P.J. 94, 115, 158 [52]; 537, 586 [54]
 Tricomi, F. 536, 541, 589 [125]; 589 [126]
 Trombetta, M. 156, 159 [75]
 Trudinger, N.S. 330, 357 [213]; 362, 435 [108]
 Tso, K. 416, 417, 435 [109]
 Tsouli, N. 335, 336, 350 [13]
 Tvrđý, M. 115, 160 [87]
 Ugulava, D. 354 [122]
 Ulm, M. 313, 352 [77]
 Ureña, A.J. 537, 561, 562, 586 [30]; 586 [31]; 589 [127]

- Usami, H. 327, 354 [140]; 356 [180]; 356 [182]
 Usikov, P.A. 536, 589 [117]
- Vaillancourt, F. 585 [13]
 Valeeva, R.T. 481, 531 [99]
 Viano, M. 482, 530 [47]; 530 [48]; 530 [49];
 530 [50]
 Villari, G. 350 [38]; 350 [39]; 350 [40]; 350 [41]
 Vitt, A.A. 540, 541, 585 [6]
 Volterra, V. 442, 504, 532 [100]
 Vrdoljak, B. 659, 683 [84]
- Walcher, S. 454, 532 [101]
 Walter, W. 71, 160 [101]; 356 [202]
 Waltman, P. 3, 68 [15]
 Wang, J. 354 [142]
 Wang, Q.-R. 357 [216]
 Wang, T. 134, 159 [67]
 Wang, X.-J. 362, 417, 435 [108]; 435 [110]
 Wang, Z.-Q. 134, 157 [10]; 420, 428, 430,
 434 [90]; 434 [101]
 Ward, J.R., Jr. 537, 589 [128]
 Warner, F.W. 405, 433 [63]
 Wasserman, A. 425, 434 [105]
 Ważewski, T. 356 [185]; 595, 596, 599, 606, 607,
 611, 612, 614, 659, 662, 683 [85]; 683 [86];
 684 [87]; 684 [88]; 684 [89]
 Weigu Li 456, 515, 517, 530 [63]; 530 [64]
 Weil, J.A. 532 [102]
 Weinberger, H.F. 139, 155, 160 [85]
 Weiyue Ding 562, 586 [39]
 Willem, M. 428, 429, 435 [111]; 536, 544, 546,
 547, 549, 551, 552, 554, 556, 563–565, 579,
 584, 586 [45]; 586 [48]; 587 [68]; 588 [85];
 588 [86]; 589 [129]; 630–633, 682 [31]
 Willet, D. 357 [217]
 Wilson, F.W. 668, 684 [90]
 Wojciechowski, S. 439, 505, 530 [53]; 531 [97]
 Wójcik, K. 665–667, 683 [79]; 684 [91]; 684 [92];
 684 [93]; 684 [94]; 684 [95]; 684 [96]; 684 [97]
- Wong, J.S. 357 [215]
 Wong, P.J.Y. 3, 67 [6]; 327, 357 [218]; 357 [219]
- Xiang Zhang 456, 530 [64]
- Yablonskii, A.I. 475, 532 [103]
 Yamamoto, M. 356 [181]
 Yan, J. 357 [220]; 357 [221]
 Yang, X. 357 [222]; 357 [223]; 357 [224];
 357 [225]
 Ye Yanqian 475, 478, 488, 532 [104]
 Yeh, C.C. 349 [4]; 353 [111]; 355 [150];
 355 [151]; 355 [152]; 355 [153]; 355 [154];
 355 [155]; 357 [226]
 Yihong Du 547, 586 [42]
 Yiu-Kwong Man 455, 531 [73]
 Yorke, J.A. 662, 668, 682 [42]; 684 [90]
 Yoshida, N. 327, 333, 353 [118]; 354 [141]
 Yu Hongan 576, 588 [97]
- Zakharin, S.F. 589 [135]
 Zandron, O.P. 439, 530 [51]
 Zanolin, F. 3, 4, 68 [16]; 90, 91, 94, 115, 119, 134,
 158 [39]; 158 [42]; 158 [53]; 159 [54];
 159 [76]; 313, 355 [165]; 355 [168]; 371, 379,
 380, 393, 432 [48]; 433 [73]; 562, 565, 586 [46]
 Zaslavsky, G.M. 536, 589 [117]
 Zecca, P. 364, 431 [2]
 Zehnder, E. 572, 587 [67]; 651, 676, 680 [2];
 681 [23]
 Zezza, P. 355 [174]
 Zgliczyński, P. 666, 667, 684 [94]; 684 [95];
 684 [96]; 684 [97]
 Zhang, G. 357 [227]
 Zhang, X. 491, 492, 515, 517, 528, 529 [33];
 530 [63]; 531 [71]
 Zhang Zhifen 478, 532 [105]
 Zhaoli Liu 134, 159 [68]
 Zhong, C. 353 [99]
 Żołądek, H. 491, 502, 532 [106]; 532 [107]
 Zou, H. 428, 430, 434 [102]

Subject Index

- 2-torus 523
- α -limit 516
- ω -limit 516

- \mathcal{A} -Carathéodory function 90
- absolute 631
- action functional 546
- action integral 535
- almost periodic coefficient 270
- almost periodic function 582, 583
- annular domain 361, 364, 392
- annular system 516
- ANR (absolute neighborhood retract) 629, 630, 632, 634–638, 642, 648–650, 654
- Armellini–Tonelli–Sansone theorem 279, 281
- Arrhenius equation 405
- asymptotic part 604, 636, 638, 639
- asymptotic properties 215
- Aubry–Mather’s twist theorem 574
- average 577
- averaging technique 256

- Banach space 372, 420
- base point 627, 629, 677
- Besicovitch almost periodic function 271
- bifurcation 364
- bifurcation equation 543
- bifurcation from infinity 420
- bifurcation of solutions 369
- bifurcation point 369
- bifurcation problems 369
- bifurcation results 419
- Birkhoff point 573
- Birkhoff’s twist theorem 573
- blow-up 405
- Bott’s iteration formula 564
- boundary value problem 1, 3, 8, 21, 41, 42, 47, 361, 363, 396, 399
- bounded function 577
- bounded Palais–Smale condition (BPS) 547
- bounded solution 577, 578

- C^k -equivalent systems 516
- C^k -parallel systems 516
- Calabi invariant 572
- canonical region 517
- Carathéodory conditions 72
- Carathéodory functions 72
- category 594, 601, 602, 630, 631, 633, 636, 642, 648, 674
- category, relative 630, 650
- center 485
- chaotic dynamics 574
- chemical kinetics 405
- circular cylinder 522
- circular paraboloid 521
- class \mathbb{M}^+ 215, 216, 222, 223
- class \mathbb{M}^- 215, 216, 222–224, 226
- class \mathbb{M}_0^- 217, 220, 221
- class \mathbb{M}_B^+ 217, 218, 227
- class \mathbb{M}_B^- 217, 218, 221
- class \mathbb{M}_∞^+ 217, 220, 227
- closed systems 442
- cofactor 520
- cofactor of an exponential factor 447
- cofactor of an invariant algebraic curve 444
- coincidence degree 544
- compact embedding 428
- complete continuity 374, 377
- completely continuous 365, 420
- completely continuous mapping 404
- completely continuous operator 369, 372, 376, 388, 393
- complex polynomial system 440
- complex solution 440
- conditionally oscillatory equation 283
- cone 522
- configuration of limit cycles 480
- conjugate equation 176
- conjugate number of p 167
- conjugate points 176, 241
- Conley index 593, 600–602, 667, 671, 672, 674–678, 680
- Conley index, cohomological 674

- Conley index, homological 674
 Conley theorem, first 600, 668
 Conley theorem, second 600, 669
 consecutive minimizers 574
 constant torque 536, 540, 541
 constraint 428
 continuation methods 401, 427
 continuation theorem 390, 394, 404
 continuous embedding 415
 contraction mapping principle 367
 coupled lower and upper quasi-solutions 152
 critical dimension 418, 419
 critical exponent 416–419
 critical group 565
 critical orbit 549
 critical point 314, 408, 416, 424, 428, 546
 critical point theorems 370
 critical point theory 430
 critical value 314, 546
 cup-length 601, 602, 632, 633, 636, 647, 674
 curvature problems 405
- Darboux lemma 461, 466
 Darboux proposition 468
 Darbouxian function 452
 Darbouxian theory of integrability 449
 degeneracy 556
 degeneracy problem 554
 degree of a homogeneous ideal 462
 degree of a polynomial system 440
 degree of a polynomial vector field 518
 degree of an algebraic limit cycle 475
 degree theory 364, 381, 427
 density of the sequence of intervals 279
 derivation 500
 differential field 500
 diffusion coefficients 405
 diffusion problems 363
 direct method of the calculus of variations 535, 546
 Dirichlet boundary conditions 406
 Dirichlet boundary value problem 330
 disconjugate equation 175
 discrete Picone identity 338
 discrete quadratic functional 338
 distance of consecutive zeros 275
 divergence 442
 divergence theorem 414
 dominant solution 300
 Dulac function 488
- egress 604
 egress point 593, 595–599, 604, 660
 egress point, strict 595–597, 599, 600, 604, 611, 612, 619, 660
 egress point, strong 599
 eigenfunction 293, 330, 424
 eigenvalue 293, 330, 365
 eigenvalue problem 365, 417
 elementary first integral 501
 ellipsoid 521
 elliptic cylinder 522
 elliptic paraboloid 521
 Emden–Fowler differential equation 168
 Emden–Fowler equation 326
 energy functional 174, 242, 316, 336, 414, 425
 ENR (Euclidean neighborhood retract) 630, 634, 635, 644, 651, 652, 655, 665, 674
 entrance set 639, 640, 653
 entrance set, proper 653, 663
 equilibrium points 408
 escape-time function 599, 605, 607, 616, 623, 625, 638, 655, 665
 escape-time function, extended 606
 Euler beta function 324
 Euler–Lagrange equation 416
 Euler-type differential equation 188, 200
 Euler-type equation 234
 eventually minimal solution 189
 evolutionary operator 653
 exact system 442
 excision property 382, 385
 existence principles 4, 6
 exit set 599, 600, 604, 609, 611–613, 616, 619, 622, 638, 646–648, 653, 661, 673, 676
 exit set, proper 653, 663
 exponential factor 447
 exponential factor on a surface 520
 exterior domain 361
- fine focus 485
 fine focus of order k 485
 first integral 441, 519
 first integral associated to an integrating factor 442
 fixed point 372, 376, 378, 381, 393, 395, 396
 fixed point index 594, 600–602, 634, 635, 651, 652, 656, 666, 672
 forced half-linear differential equation 284
 Frank-Kamenetskii approximation 405
 Fredholm alternative 182, 317
 free conservative pendulum equation 537
 free damped pendulum 539
- G -invariant 549
 gap of an orthogonal system 463
 Gelfand problem 427

- Gelfand type problems 404
 generalized polyfacial set 644, 663
 generalized Prüfer transformation 168, 169, 275
 generalized Pythagorean identity 168
 generalized sine function 169
 generalized zero 339
 geometrically distinct 543
 global bifurcation 378
 gradient of a function 518
 gradient-like 602, 637, 648, 649, 651, 668, 674
 graininess 348
 ground states 363, 428, 430
- H*-function averaging technique 272
 half-linear cosine function 183, 232, 275, 296
 half-linear cotangent 169
 half-linear difference equation 338
 half-linear differential equation 167
 half-linear dynamic equations 348
 half-linear Prüfer transformation 232, 294, 296
 half-linear sine function 183, 192, 232, 275, 296
 half-linear tangent 169
 Hamiltonian 481
 Hamiltonian vector field 481
 Harnack inequality 330
 Hartman–Wintner theorem 203, 257, 264
 Hessian matrix 362
 heteroclinic orbit 408, 539
 heteroclinic solutions 575
 Hilbert's Nullstellensatz 492
 Hille–Wintner comparison theorem 207, 212
 homoclinic orbits 539
 homogeneity conditions 365
 homogeneous polynomial vector field 468
 homotopic deformation along p 320
 homotopy type 600, 601, 628, 631, 633, 670, 675–677
 homotopy type, absolute 628, 629, 631, 675, 677
 homotopy type, pointed 628, 629, 631, 633, 677
 homotopy types 601
 Hopf bifurcation 485
 hyperbolic cylinder 522
 hyperbolic paraboloid 521
 hyperboloid of one sheet 522
 hyperboloid of two sheets 521
- indefinite weight 295
 independent points 448, 525
 index calculations 365
 index of stationary points 651, 652
 ingress point 595, 596
 ingress point, strict 595, 600, 611
 initial value problem 1, 3, 51, 65, 66, 367
 integrable system 441
 integral characterization 236, 240
 integral curve 440
 integral equation 376
 integral J_1 217
 integral J_2 217
 integral J_c 216
 integral J_f 216
 integral R_1 223
 integral R_2 223
 integrating factor 442
 intermittently tending function 279
 intersection index 462
 intersection index at a point 462
 invariant 441
 invariant algebraic curve 444
 invariant algebraic curve on a surface 519
 invariant part 593, 600, 638–640, 642, 643, 647, 648, 652, 679, 680
 invariant part, negative 639
 invariant part, positive 639
 irreducible invariant algebraic curve 446
 irreducible orthogonal system 463
 isolated invariant set 600–602, 667–669, 671, 672, 674, 676–680
 isolated set of fixed points 635, 651, 655
 isolating block 593, 600, 602, 638–640, 642–649, 651–654, 656, 667–671, 673–676, 679
 isolating neighborhood 600, 667, 668, 674, 680
 isolating segment 602, 652–654, 657, 658, 663, 664, 666, 667
 isolating segment, periodic 654–656, 665, 666
 isothermal gas 362, 408
- k -Hessian 419
 k -Hessian equation 416
 k -Hessian operator 362, 410
 Kamenev criterion 263
 Kapteyn–Bautin theorem 452
 Krasnoselskii genus 315, 335
- L^p -Carathéodory condition 72
 L^p -Carathéodory function 72
 Lagrange multiplier 428
 Lagrange stability 572
 Lagrangian 414–417
 Landesman–Lazer conditions 321
 Landesman–Lazer results 421
 Lefschetz fixed point theorem 601, 635, 638, 662
 Lefschetz number 634, 654
 left disfocal equation 250
 left jump operator 348

- Leighton–Wintner criterion 303
- Leighton–Wintner oscillation criterion 178
- Leray–Schauder alternative 4, 6, 7
- Leray–Schauder degree 319, 366, 382, 384, 385, 389
- Liapunov function 486, 487, 610, 637, 648–650
- Liapunov quantity 485
- limit characterization 222, 241
- limit cycle 475
- linear differential equations 443
- Liouville theorem 501
- Liouville–Gelfand equation 405, 406
- Liouville–Gelfand problem 361, 405, 409
- Liouvillian first integral 452, 501, 503
- local flow 595, 598, 600–603, 608–611, 617, 619, 621, 624, 636–638, 642–644, 646, 648, 651–653, 667–669, 671–674, 676–680
- local ring 462
- local semiflow 601–604, 610, 620–622, 625, 636–638, 652
- Lotka–Volterra system 442, 503
- lower semicontinuous function 430
- lower solution 73, 83, 89, 391, 404
- Lusternik–Schnirelman 549
- Lusternik–Schnirelman procedure 314
- Lyapunov inequality 246
- Lyapunov stability 558
- Lyapunov–Schmidt’s decomposition 543

- Mather set 570, 574
- maximum principle 361, 391
- measure chain 348
- Milloux theorem 279
- minimal and maximal solution 77
- minimal function 566
- minimal solution 231, 256
- minus gradient flow 122
- mode 426
- Monge–Ampère operator 362, 417
- Monge–Ampère version of the Liouville–Gelfand equation 409
- monodromy homeomorphism 654, 657, 658
- monotone increasing map 136
- monotone operator 377
- monotone twist homeomorphism 573
- Morse index 564, 601, 676
- Morse index, generalized 601
- Morse theory 427
- Moser’s twist theorem 571
- mountain pass lemma 547
- mountain pass theorem 428, 429
- multi-bump solutions 575
- multiple point 469
- multiplicity 13
- multiplicity of a curve at a point 469
- multiplicity of a point 462
- multiplicity results 362

- Nagumo condition 81, 83
- negative half-orbit 516
- negative semitrajectory 596, 603
- Neumann lemma 517
- nodal contour 335
- nodal domain 335
- nonoscillation theorems 363
- nonoscillatory equation 176, 197, 341
- nonradial solution 425–427
- nonresonant case 182
- nonuniform nonresonance 321
- normal cone 135

- one-sided Nagumo condition 82, 83
- open question 460, 480
- orbit 440
- order 135
- order cone 135
- Orlicz–Sobolev conjugate 385
- orthogonal complement 422
- orthogonal system of polynomials 462
- orthogonal system without projective zero 463
- oscillation 367
- oscillation constant 283
- oscillation theorems 363
- oscillatory equation 176, 197, 341
- oscillatory solutions 367, 376
- oscillatory term 422
- outward tangency point 595, 600, 611, 612, 619

- p -Laplace operator 379
- p -Laplacian 318, 329, 334, 381
- p -Laplacian operator 410
- Palais–Smale condition (PS) 126, 314, 318, 335, 428, 547
- Palais–Smale sequence 547
- parabolic cylinder 521
- parallel neighborhood 516
- partial order 377
- partially ordered Banach space 376
- periodic coefficient 268
- periodic solution of the second kind 539, 565
- periodically forced pendulum 541
- perturbation of two-term half-linear equation 302
- phase plane 407
- phase portrait 441
- Picone’s identity 172, 243, 333
- planar polynomial differential system 440

- Pohozaev identity 415
 Poincaré map 656, 664, 676
 Poincaré mapping 553
 Poincaré–Birkhoff fixed point theorem 562
 pointed space 600, 627, 628, 677
 points 611
 polyfacial set 596, 601, 610–614, 616, 618, 621–624, 626
 polyfacial set, generalized 601, 617–620
 polyfacial set, regular 612, 613, 616
 polynomial 1-form 440
 polynomial system 440
 polynomial vector field 440, 518
 polynomial vector field on a surface 519
 positive half-orbit 516
 positive semitrajectory 596, 599, 600, 603, 604, 609, 610, 622
 positively invariant set 124
 positone 3, 8
 positone problems 400
 primary limit cycle 480
 principal eigenfunction 422
 principal eigenvalue 370, 371, 378, 418, 420
 principal solution 197, 222, 229, 231, 233, 236, 242, 305
 projective homogeneous 1-form 468
 proper solution 326
 Prüfer transformation 192, 280
 (PS)_c-condition 547
 (PS)_G-condition 549
 pseudolaplacian 336
 Pythagorean identity 297
- quasi-isotopic deformation retract 601, 608–610, 614
 quasi-jumping function 279
- radial eigenvalues 361
 radial solutions 361
 radial symmetry 361
 Rayleigh quotient 330
 Rayleigh–Ritz inequality 43
 real polynomial system 440
 real solution 440
 realization of a configuration of limit cycles 481
 reciprocal equation 178, 240
 reciprocity principle 178, 215
 reduction method of Liapunov–Schmidt’s type 550
 regular growth 279
 regular half-linear equation 240
 regular polyfacial set 657, 669
 regular Sturm–Liouville problem 295
 regular surface 519
 regular value 556
 regularly varying function 229
 Rellich–Pohozaev identity 412
 repelling node 408
 resonant case 321
 retarded half-linear equation 286
 retract 593, 594, 596–598, 606, 607, 621, 623, 624, 626, 629, 630, 650, 661, 664
 retract method 593, 594, 596
 Riccati difference equation 338
 Riccati inequality 200, 201, 343, 345
 Riccati integral equation 207, 265
 Riccati integral inequality 210
 Riccati substitution 172, 249
 Riccati technique 180, 197, 343
 Riccati-type differential equation 171
 right difocal equation 250
 right focal point 249
 right jump operator 348
 rotating solution 566
 rotation number 566, 568, 573
 roundabout theorem 174, 197, 338
- Schauder 4, 6, 7, 25, 28, 30, 46, 47, 54, 57, 59
 Schauder–Tychonov fixed point theorem 208, 212, 326
 Schauder’s fixed point theorem 376
 second eigenvalue of p -Laplacian 335
 secondary bifurcations 427
 semitrajectory, negative 595
 semitrajectory, positive 595
 separatrix 517
 sign changing nonlinearities 22
 simple point 469
 singular 1, 3, 8, 13, 21, 22, 51
 singular point 242, 449
 singular solution 168, 407, 408
 singular solution of the first kind 326
 singular solution of the second kind 326
 singular Sturm–Liouville problem 300
 slowly varying function 229
 smash product 627, 628, 675
 Sobolev exponent 415
 Sobolev space 370, 428
 solution continuum 364, 373, 404
 sphere 521
 spiral node 408
 spiral system 516
 star-shaped domain 409, 412, 416
 starlike domain 412, 413
 state-space 407
 strict lower solution 94, 102
 strict upper solution 94, 102

- strictly convex domain 409
- strip system 516
- strong deformation retract 594, 599, 606–608, 610, 622, 624, 629, 630, 632, 636, 637, 639, 641, 645, 649, 670, 673, 674
- strong first integral 515
- strongly increasing solution 327
- strongly nonoscillatory equation 283
- strongly oscillatory equation 283
- Sturm type separation properties 368
- Sturm–Liouville difference equation 337
- Sturm–Liouville differential equation 167, 201
- Sturm–Liouville problem 293
- Sturmian majorant 234, 255, 295
- Sturmian oscillation theory 167
- subcritical exponents 417
- subcritical growth 380
- subdominant solution 300
- subharmonic solution 543, 563
- symmetry breaking 363, 424, 427
- symmetry breaking bifurcations 361

- T -periodic solution 542
- thermal ignition problems 362
- time scale 348
- topological degree 427
- topologically equivalent configurations of limit 481
- toral system 516
- total intersection index 462
- total multiplicity 462
- trajectory 440, 595, 603, 617, 637, 672, 676, 678
- Tricomi's equation 536
- trigonometric transformation 181, 252
- trivial pointed homotopy type 628, 674

- true minimizer 576
- Tychonov fixed point theorem 220, 222

- unbounded continuum 378
- upper and lower solutions 364, 401, 543, 583
- upper solution 73, 84, 89, 391, 404

- Vallée Poussin-type inequality 248
- variational approach 429
- variational characterization of eigenvalues 314, 322
- variational methods 370, 409, 425, 427
- variational principle 197

- Ważewski lemma 599, 601, 605, 606
- Ważewski method 593, 594, 596, 599–602, 604, 610, 613, 614, 620, 621, 626, 629, 630, 636, 658, 659, 662, 667
- Ważewski set 593, 599–602, 604–607, 610, 612, 617, 619, 622, 625, 636–639, 661
- Ważewski theorem 596–601, 604, 606–608, 614, 616, 626, 662, 673
- weak first integral 515
- weak singular point 449
- weak solutions 428
- weakly closed sets 428
- weakly increasing solution 327
- wedge sum 627, 628, 677
- weight function 256
- Willet's criteria 266
- Wirtinger inequality 198
- Wronskian identity 180, 230

- Young inequality 173, 274, 286