

Delay Differential Equations and Applications

Edited by

O. Arino, M.L. Hbid and E. Ait Dads

NATO Science Series

II. Mathematics, Physics and Chemistry – Vol. 205

Delay Differential Equations and Applications

NATO Science Series

A Series presenting the results of scientific meetings supported under the NATO Science Programme.

The Series is published by IOS Press, Amsterdam, and Springer in conjunction with the NATO Public Diplomacy Division

Sub-Series

I. Life and Behavioural Sciences	IOS Press
II. Mathematics, Physics and Chemistry	Springer
III. Computer and Systems Science	IOS Press
IV. Earth and Environmental Sciences	Springer

The NATO Science Series continues the series of books published formerly as the NATO ASI Series.

The NATO Science Programme offers support for collaboration in civil science between scientists of countries of the Euro-Atlantic Partnership Council. The types of scientific meeting generally supported are "Advanced Study Institutes" and "Advanced Research Workshops", and the NATO Science Series collects together the results of these meetings. The meetings are co-organized by scientists from NATO countries and scientists from NATO's Partner countries – countries of the CIS and Central and Eastern Europe.

Advanced Study Institutes are high-level tutorial courses offering in-depth study of latest advances in a field.

Advanced Research Workshops are expert meetings aimed at critical assessment of a field, and identification of directions for future action.

As a consequence of the restructuring of the NATO Science Programme in 1999, the NATO Science Series was re-organised to the four sub-series noted above. Please consult the following web sites for information on previous volumes published in the Series.

<http://www.nato.int/science>

<http://www.springer.com>

<http://www.iospress.nl>



Series II: Mathematics, Physics and Chemistry – Vol. 205

Delay Differential Equations and Applications

edited by

O. Arino

University of Pau, France

M.L. Hbid

University Cadi Ayyad,
Marrakech, Morocco

and

E. Ait Dads

University Cadi Ayyad,
Marrakech, Morocco

 **Springer**

Published in cooperation with NATO Public Diplomacy Division

Proceedings of the NATO Advanced Study Institute on
Delay Differential Equations and Applications
Marrakech, Morocco
9-21 September 2002

A C.I.P. Catalogue record for this book is available from the Library of Congress.

ISBN-10 1-4020-3646-9 (PB)
ISBN-13 978-1-4020-3646-0 (PB)
ISBN-10 1-4020-3645-0 (HB)
ISBN-13 978-1-4020-3645-3 (HB)
ISBN-10 1-4020-3647-7 (e-book)
ISBN-13 978-1-4020-3647-7 (e-book)

Published by Springer,
P.O. Box 17, 3300 AA Dordrecht, The Netherlands.

www.springer.com

Printed on acid-free paper

All Rights Reserved

© 2006 Springer

No part of this work may be reproduced, stored in a retrieval system, or transmitted in any form or by any means, electronic, mechanical, photocopying, microfilming, recording or otherwise, without written permission from the Publisher, with the exception of any material supplied specifically for the purpose of being entered and executed on a computer system, for exclusive use by the purchaser of the work.

Contents

List of Figures	xiii
Preface	xvii
Contributing Authors	xxi
Introduction <i>M. L. Hbid</i>	xxiii
1	
History Of Delay Equations <i>J.K. Hale</i>	1
1 Stability of equilibria and Lyapunov functions	3
2 Invariant Sets, Omega-limits and Lyapunov functionals.	7
3 Delays may cause instability.	10
4 Linear autonomous equations and perturbations.	12
5 Neutral Functional Differential Equations	16
6 Periodically forced systems and discrete dynamical systems.	20
7 Dissipation, maximal compact invariant sets and attractors.	21
8 Stationary points of dissipative flows	24
Part I General Results and Linear Theory of Delay Equations in Finite Dimensional Spaces	29
2	
Some General Results and Remarks on Delay Differential Equations <i>E. Ait Dads</i>	31
1 Introduction	31
2 A general initial value problem	33
2.1 Existence	34
2.2 Uniqueness	35
2.3 Continuation of solutions	37
2.4 Dependence on initial values and parameters	38
2.5 Differentiability of solutions	40

3

Autonomous Functional Differential Equations	41
<i>Franz Kappel</i>	
1 Basic Theory	41
1.1 Preliminaries	41
1.2 Existence and uniqueness of solutions	44
1.3 The Laplace-transform of solutions. The fundamental matrix	46
1.4 Smooth initial functions	54
1.5 The variation of constants formula	55
1.6 The Spectrum	59
1.7 The solution semigroup	68
2 Eigenspaces	71
2.1 Generalized eigenspaces	71
2.2 Projections onto eigenspaces	90
2.3 Exponential dichotomy of the state space	101
3 Small Solutions and Completeness	104
3.1 Small solutions	104
3.2 Completeness of generalized eigenfunctions	109
4 Degenerate delay equations	110
4.1 A necessary and sufficient condition	110
4.2 A necessary condition for degeneracy	116
4.3 Coordinate transformations with delays	119
4.4 The structure of degenerate systems with commensurate delays	124
Appendix: A	127
Appendix: B	129
Appendix: C	131
Appendix: D	132
References	137
Part II Hopf Bifurcation, Centre manifolds and Normal Forms for Delay Differential Equations	141
4	
Variation of Constant Formula for Delay Differential Equations	143
<i>M.L. Hbid and K. Ezzinbi</i>	
1 Introduction	143
2 Variation Of Constant Formula Using Sun-Star Machinery	145
2.1 Duality and semigroups	145
2.1.1 The variation of constant formula:	146
2.2 Application to delay differential equations	147
2.2.1 The trivial equation:	147
2.2.2 The general equation	149
3 Variation Of Constant Formula Using Integrated Semigroups Theory	149
3.1 Notations and basic results	150
3.2 The variation of constant formula	153

5

Introduction to Hopf Bifurcation Theory for Delay Differential Equations	161
--	-----

M.L. Hbid

1	Introduction	161
	1.1 Statement of the Problem:	161
	1.2 History of the problem	163
	1.2.1 The Case of ODEs:	163
	1.2.2 The case of Delay Equations:	164
2	The Lyapunov Direct Method And Hopf Bifurcation: The Case Of Ode	166
3	The Center Manifold Reduction Of DDE	168
	3.1 The linear equation	169
	3.2 The center manifold theorem	172
	3.3 Back to the nonlinear equation:	177
	3.4 The reduced system	179
4	Cases Where The Approximation Of Center Manifold Is Needed	182
	4.1 Approximation of a local center manifold	183
	4.2 The reduced system	188

6

An Algorithmic Scheme for Approximating Center Manifolds and Normal Forms for Functional Differential Equations	193
---	-----

M. Ait Babram

1	Introduction	193
2	Notations and background	195
3	Computational scheme of a local center manifold	199
	3.1 Formulation of the scheme	202
	3.2 Special cases.	209
	3.2.1 Case of Hopf singularity	209
	3.2.2 The case of Bogdanov -Takens singularity.	210
4	Computational scheme of Normal Forms	213
	4.1 Normal form construction of the reduced system	214
	4.2 Normal form construction for FDEs	221

7

Normal Forms and Bifurcations for Delay Differential Equations	227
--	-----

T. Faria

1	Introduction	227
2	Normal Forms for FDEs in Finite Dimensional Spaces	231
	2.1 Preliminaries	231
	2.2 The enlarged phase space	232
	2.3 Normal form construction	234
	2.4 Equations with parameters	240
	2.5 More about normal forms for FDEs in \mathbb{R}^n	241
3	Normal forms and Bifurcation Problems	243
	3.1 The Bogdanov-Takens bifurcation	243
	3.2 Hopf bifurcation	246

4	Normal Forms for FDEs in Hilbert Spaces	253
4.1	Linear FDEs	254
4.2	Normal forms	256
4.3	The associated FDE on \mathbb{R}	258
4.4	Applications to bifurcation problems	260
5	Normal Forms for FDEs in General Banach Spaces	262
5.1	Adjoint theory	263
5.2	Normal forms on centre manifolds	268
5.3	A reaction-diffusion equation with delay and Dirichlet conditions	270
	References	275
Part III Functional Differential Equations in Infinite Dimensional Spaces		283
8		
A	Theory of Linear Delay Differential Equations in Infinite Dimensional Spaces	285
	<i>O. Arino and E. Sánchez</i>	
1	Introduction	285
1.1	A model of fish population dynamics with spatial diffusion (11)	286
1.2	An abstract differential equation arising from cell population dynamics	288
1.3	From integro-difference to abstract delay differential equations (8)	292
1.3.1	The linear equation	292
1.3.2	Delay differential equation formulation of system (1.5)-(1.6)	295
1.4	The linearized equation of equation (1.17) near non-trivial steady-states	297
1.4.1	The steady-state equation	297
1.4.2	Linearization of equation (1.17) near (\bar{n}, \bar{N})	298
1.4.3	Exponential solutions of (1.20)	299
1.5	Conclusion	303
2	The Cauchy Problem For An Abstract Linear Delay Differential Equation	303
2.1	Resolution of the Cauchy problem	304
2.2	Semigroup approach to the problem (CP)	306
2.3	Some results about the range of $\lambda I - A$	310
3	Formal Duality	311
3.1	The formal adjoint equation	313
3.2	The operator A^* formal adjoint of A	316
3.3	Application to the model of cell population dynamics	317
3.4	Conclusion	320
4	Linear Theory Of Abstract Functional Differential Equations Of Retarded Type	320
4.1	Some spectral properties of C_0 -semigroups	321

4.2	Decomposition of the state space $C([-r, 0]; E)$	324
4.3	A Fredholm alternative principle	326
4.4	Characterization of the subspace $\mathcal{R}(\lambda I - A)^m$ for λ in $(\sigma \setminus \sigma_e)(A)$	326
4.5	Characterization of the projection operator onto the subspace Q_Λ	331
4.6	Conclusion	335
5	A Variation Of Constants Formula For An Abstract Functional Differential Equation Of Retarded Type	335
5.1	The nonhomogeneous problem	336
5.2	Semigroup defined in $\mathcal{L}(E)$	337
5.3	The fundamental solution	338
5.4	The fundamental solution and the nonhomogeneous problem	341
5.5	Decomposition of the nonhomogeneous problem in $C([-r, 0]; E)$	344
9		
	The Basic Theory of Abstract Semilinear Functional Differential Equations with Non-Dense Domain	347
	<i>K. Ezzinbi and M. Adimy</i>	
1	Introduction	347
2	Basic results	350
3	Existence, uniqueness and regularity of solutions	354
4	The semigroup and the integrated semigroup in the autonomous case	372
5	Principle of linearized stability	381
6	Spectral Decomposition	383
7	Existence of bounded solutions	385
8	Existence of periodic or almost periodic solutions	391
9	Applications	393
	References	399
	Part IV More on Delay Differential Equations and Applications	409
10		
	Dynamics of Delay Differential Equations	411
	<i>H.O. Walther</i>	
1	Basic theory and some results for examples	411
1.1	Semiflows of retarded functional differential equations	411
1.2	Periodic orbits and Poincaré return maps	416
1.3	Compactness	418
1.4	Global attractors	418
1.5	Linear autonomous equations and spectral decomposition	419
1.6	Local invariant manifolds for nonlinear RFDEs	423
1.7	Floquet multipliers of periodic orbits	425
1.8	Differential equations with state-dependent delays	435

2	Monotone feedback: The structure of invariant sets and attractors	436
2.1	Negative feedback	437
2.2	Positive feedback	439
3	Chaotic motion	451
4	Stable periodic orbits	456
5	State-dependent delays	468
11		
	Delay Differential Equations in Single Species Dynamics	477
	<i>S. Ruan</i>	
1	Introduction	477
2	Hutchinson's Equation	478
2.1	Stability and Bifurcation	479
2.2	Wright Conjecture	481
2.3	Instantaneous Dominance	483
3	Recruitment Models	484
3.1	Nicholson's Blowflies Model	484
3.2	Houseflies Model	486
3.3	Recruitment Models	487
4	The Allee Effect	488
5	Food-Limited Models	489
6	Regulation of Haematopoiesis	491
6.1	Mackey-Glass Models	491
6.2	Wazewska-Czyzewska and Lasota Model	493
7	A Vector Disease Model	493
8	Multiple Delays	495
9	Volterra Integrodifferential Equations	496
9.1	Weak Kernel	498
9.2	Strong Kernel	500
9.3	General Kernel	502
9.4	Remarks	504
10	Periodicity	505
10.1	Periodic Delay Models	505
10.2	Integrodifferential Equations	507
11	State-Dependent Delays	511
12	Diffusive Models with Delay	514
12.1	Fisher Equation	514
12.2	Diffusive Equations with Delay	515
12		
	Well-Posedness, Regularity and Asymptotic Behaviour of Retarded Differential Equations by Extrapolation Theory	519
	<i>L. Maniar</i>	
1	Introduction	519
2	Preliminaries	521
3	Homogeneous Retarded Differential Equations	525

13

Time Delays in Epidemic Models: Modeling and Numerical Considerations 539

J. Arino and P. van den Driessche

1	Introduction	539
2	Origin of time delays in epidemic models	540
2.1	Sojourn times and survival functions	540
2.2	Sojourn times in an SIS disease transmission model	541
3	A model that includes a vaccinated state	544
4	Reduction of the system by using specific $P(t)$ functions	548
4.1	Case reducing to an ODE system	548
4.2	Case reducing to a delay integro-differential system	549
5	Numerical considerations	550
5.1	Visualising and locating the bifurcation	550
5.2	Numerical bifurcation analysis and integration	551
6	A few words of warning	552

Appendix 555

1	Program listings	555
1.1	MatLab code	556
1.2	XPPAUT code	557
2	Delay differential equations packages	557
2.1	Numerical integration	557
2.2	Bifurcation analysis	558

References 559

Index 579

List of Figures

10.1	413
10.2	413
10.3	417
10.4	417
10.5	420
10.6	422
10.7	423
10.8	424
10.9	425
10.10	427
10.11	428
10.12	430
10.13	431
10.14	432
10.15	432
10.16	434
10.17	438
10.18	439
10.19	441
10.20	442
10.21	443
10.22	445
10.23	446
10.24	447
10.25	447
10.26	449
10.27	450
10.28	451
10.29	453

10.30	453
10.31	454
10.32	457
10.33	459
10.34	459
10.35	463
10.36	464
10.37	465
10.38	466
11.1	The bifurcation diagram for equation (2.1). 481
11.2	The periodic solution of the Hutchinson's equation (2.1). 481
11.3	Numerical simulations for the Hutchinson's equation (2.1). Here $r = 0.15, K = 1.00$. (i) When $\tau = 8$, the steady state $x^* = 1$ is stable; (ii) When $\tau = 11$, a periodic solution bifurcated from $x^* = 1$. 482
11.4	Oscillations in the Nicholson's blowflies equation (3.1). Here $P = 8, x_0 = 4, \delta = 0.175$, and $\tau = 15$. 486
11.5	Aperiodic oscillations in the Nicholson's blowflies equation (3.1). Here $P = 8, x_0 = 4, \delta = 0.475$, and $\tau = 15$. 486
11.6	Numerical simulations in the houseflies model (3.2). Here the parameter values $b = 1.81, k = 0.5107, d = 0.147, z = 0.000226, \tau = 5$ were reported in Taylor and Sokal (1976). 487
11.7	The steady state of the delay model (4.1) is attractive. Here $a = 1, b = 1, c = 0.5, \tau = 0.2$. 489
11.8	The steady state of the delay food-limited model (5.3) is stable for small delay ($\tau = 8$) and unstable for large delay ($\tau = 12.8$). Here $r = 0.15, K = 1.00, c = 1$. 491
11.9	Oscillations in the Mackey-Glass model (6.1). Here $\lambda = 0.2, a = 01, g = 0.1, m = 10$ and $\tau = 6$. 492
11.10	Aperiodic behavior of the solutions of the Mackey-Glass model (6.1). Here $\lambda = 0.2, a = 01, g = 0.1, m = 10$ and $\tau = 20$. 492

- 11.11 Numerical simulations for the vector disease equation (7.1). When $a = 5.8, b = 4.8 (a > b)$, the zero steady state $u = 0$ is asymptotically stable; When $a = 3.8, b = 4.8 (a < b)$, the positive steady state u^* is asymptotically stable for all delay values; here for both cases $\tau = 5$. 494
- 11.12 For the two delay logistic model (8.1), choose $r = 0.15, a_1 = 0.25, a_2 = 0.75$. (a) The steady state (a) is stable when $\tau_1 = 15$ and $\tau_2 = 5$ and (b) becomes unstable when $\tau_1 = 15$ and $\tau_2 = 10$, a Hopf bifurcation occurs. 496
- 11.13 (a) Weak delay kernel and (b) strong delay kernel. 498
- 11.14 The steady state of the integrodifferential equation (9.1) is globally stable. Here $r = 0.15, K = 1.00$. 500
- 11.15 The steady state $x^* = K$ of the integrodifferential equation (9.10) loses stability and a Hopf bifurcation occurs when α changes from 0.65 to 0.065. Here $r = 0.15, K = 1.00$. 502
- 11.16 Numerical simulations for the state-dependent delay model (11.3) with $r = 0.15, K = 1.00$ and $\tau(x) = a + bx^2$. (i) $a = 5, b = 1.1$; and (ii) $a = 9.1541, b = 1.1$. 512
- 11.17 The traveling front profiles for the Fisher equation (12.1). Here $D = r = K = 1, c = 2.4 - 3.0$ 515
- 13.1 The transfer diagram for the SIS model. 542
- 13.2 The transfer diagram for the SIV model. 545
- 13.3 Possible bifurcation scenarios. 551
- 13.4 Bifurcation diagram and some solutions of (4.3). (a) and (b): Backward bifurcation case, parameters as in the text. (c) and (d): Forward bifurcation case, parameters as in the text except that $\sigma = 0.3$. 553
- 13.5 Value of I^* as a function of ω by solving $H(I, \omega) = 0$, parameters as in text. 554
- 13.6 Plot of the solution of (6.2), with parameters as in the text, using `dde23`. 555

Preface

This book groups material that was used for the Marrakech 2002 School on Delay Differential Equations and Applications. The school was held from September 9-21 2002 at the Semlalia College of Sciences of the Cadi Ayyad University, Marrakech, Morocco. 47 participants and 15 instructors originating from 21 countries attended the school. Financial limitations only allowed support for part of the people from Africa and Asia who had expressed their interest in the school and had hoped to come. The school was supported by financements from NATO-ASI (Nato advanced School), the International Centre of Pure and Applied Mathematics (CIMPA, Nice, France) and Cadi Ayyad University. The activity of the school consisted in courses, plenary lectures (3) and communications (9), from Monday through Friday, 8.30 am to 6.30 pm. Courses were divided into units of 45mn duration, taught by block of two units, with a short 5mn break between two units within a block, and a 25mn break between two blocks. The school was intended for mathematicians willing to acquire some familiarity with delay differential equations or enhance their knowledge on this subject. The aim was indeed to extend the basic set of knowledge, including ordinary differential equations and semilinear evolution equations, such as for example the diffusion-reaction equations arising in morphogenesis or the Belousov-Zhabotinsky chemical reaction, and the classic approach for the resolution of these equations by perturbation, to equations having in addition terms involving past values of the solution. In order to achieve this goal, a training programme was devised that may be summarized by the following three keywords: the Cauchy problem, the variation of constants formula, local study of equilibria. This defines the general method for the resolution of semilinear evolution equations, such as the diffusion-reaction equation, adapted to delay differential equations. The delay introduces specific differences and difficulties which are taken into account in the progression of the course, the first week having been devoted to “ordinary” delay differential equations, such equations where the only independent variable is the time variable; in addition, only the finite dimension was

considered. During the second week, attention was focused on “ordinary” delay differential equations in infinite dimensional vector spaces, as well as on partial differential equations with delay. Aside the training on the basic theory of delay differential equations, the course by John Mallet-Paret during the first week discussed very recent results motivated by the problem of determining wave fronts in lattice differential equations. The problem gives rise to a differential equation with deviated arguments (both retarded and advanced), which represents an entirely new line of research. Also, during the second week, Hans-Otto Walther presented results regarding existence and description of the attractor of a scalar delay differential equation. Three plenary conferences usefully extended the contents of the first week courses. The main part of the courses given in the school are reproduced as lectures notes in this book. A quick description of the contents the book is given in the general introduction.

As many events of this nature at that time, this school was under the scientific supervision of Ovide Arino. He wanted this book to be published, and did a lot to that effect. He unfortunately passed away on September 29, 2003. This book is dedicated to him.

J. Arino and M.L. Hbid

**This book is dedicated
to the memory of
Professor Ovide Arino**

Contributing Authors

Elhadi Ait Dads, Professor, Cadi Ayyad University, Marrakech, Morocco.

Mohammed Ait Babram, Assistant Professor, Cadi Ayyad University of Marrakech, Morocco.

Mostafa Adimy, Professor, University of Pau, France.

Julien Arino, Assistant Professor, University of Manitoba, Winnipeg, Manitoba, Canada.

Julien took over edition of the book after Ovide's death.

Ovide Arino, Professor, Institut de Recherche pour le Developpement, Centre de Bondy, and Université de Pau, France.

P. van den Driessche, Professor, University of Victoria, Victoria, British Columbia, Canada.

Khalil Ezzinbi, Professor, Cadi Ayyad University, Marrakech, Morocco.

Jack K. Hale, Professor Emeritus, Georgia Institute of Technology, Atlanta, USA.

Tereza Faria, Professor, University of Lisboa, Portugal

Moulay Lhassan Hbid, Professor, Cadi Ayyad University, Marrakech, Morocco.

Franz Kappel, Professor, University of Graz, Austria.

Lahcen Maniar, Professor, Cadi Ayyad University, Marrakech, Morocco.

Shigui Ruan, Professor, University of Miami, USA.

Eva Sanchez, Professor, University Polytechnica de Madrid, Spain.

Hans-Otto Walther, Professor, University of Giessen, Germany.

Said Boulite, Post-Doctoral Fellow, Cadi Ayyad University, Marrakech, Morocco. (Technical realization of the book).

Introduction

M. L. Hbid

This book is devoted to the theory of delay equations and applications. It consists of four parts, preceded by an overview by Professor J.K. Hale. The first part concerns some general results on the quantitative aspects of non-linear delay differential equations, by Professor E. Ait Dads, and a linear theory of delay differential equations (DDE) by Professor F. Kappel. The second part deals with some qualitative theory of DDE : normal forms, centre manifold and Hopf bifurcation theory in finite dimension. This part groups the contributions of Professor T. Faria, Doctor M. Ait Babram and Professor M.L. Hbid. The third part corresponds to the contributions of Professors O. Arino, E. Sanchez, T. Faria, M. Adimy and K. Ezzinbi. It is devoted to discussions on quantitative and qualitative aspects of functional differential equations (FDE) in infinite dimension. The last part contains the contributions of Professors H.O. Walther, S. Ruan, L. Maniar and J. Arino.

Ait Dads's contribution deals with a direct method to provide an existence result; he then derives a number of typical properties of DDE and their solutions. An example of such exotic properties, discussed in Ait Dads's lectures, is the fact that, contrary to the flow associated with a smooth ordinary differential system of equations, which is a local diffeomorphism for all times, the semiflow associated with a DDE does not extend backward in time, degenerates in finite time and can even vanish in finite time. Many such properties are not yet understood and would certainly deserve to be thoroughly investigated. The results and conjectures presented by Ait Dads are classical and are for most of them taken from a recent monograph by J. Hale and S. Verduyn Lunel on the subject. Their inclusion in the initiation to DDE proposed by Ait Dads is mainly intended to allow readers to get some familiarity with the subject and open their horizons and possibly entice their appetite for exploring new avenues.

In his lecture notes, Franz Kappel presents the construction of the elementary solution of a linear DDE using the Laplace transform. Even if it is possible to proceed by direct methods, the Laplace transform provides an explicit expression of the elementary solution, useful in the study of spectral properties of DDEs. Kappel also dealt with a fundamental issue of the linear theory of delay differential equations, namely, that of completeness, that is to say, when is the vector space spanned by the eigenvectors total (dense in the state space)? This issue is tightly connected with another delicate and still open one, the existence of “small” solutions (solutions which approach zero at infinity faster than any exponential). This course extends the one that Prof. Kappel taught during the first school on delay differential equations held at the University of Marrakech in 1995. The very complete and elaborate lecture notes he provided for the course are in fact an extension of the ones written on the occasion of the first school. A first application of the linear and the semi linear theory presented by Ait Dads and Kappel is the study of bifurcation of equilibria in nonlinear delay differential equations dependent on one or several parameters. The typical framework here is a DDE defined in an open subset of the state space, rather a family of such equations dependent upon one parameter, which possesses for each value of the parameter a known equilibrium (the so-called “trivial equilibrium”): one studies the stability of the equilibrium and the possible changes in the linear stability status and how these changes reflect in the local dynamics of the nonlinear equation. Changes are expected near values of the parameter for which the equilibrium is a center. The delay introduces its own problems in that case, and these problems have given rise to a variety of approaches, dependent on the nature of the delay and, more recently, on the dimension of the underlying space of trajectories.

The part undertaken jointly by M.L. Hbid and M. Ait Babram deals with a panorama of the best known methods, then concentrates on a method elaborated within the dynamical systems group at the Cadi Ayyad University, that is, the direct Lyapunov method. This method consists in looking for a Lyapunov function associated with the ordinary differential equation obtained by restricting the DDE to a center manifold. The Lyapunov function is determined recursively in the form of a Taylor expansion. The same issue, in the context of partial differential equations with delay, was dealt with by T. Faria in her lecture notes. The method presented by Faria is an extension to this infinite dimensional frame of the well-known method of normal forms. The method was presented both in the case of a delay differential equation and also in the case when the equation is the sum of a delay differential equation

and a diffusion operator. Both Prof. Faria and Dr. Ait Babram discuss the Bogdanov-Takens and the Hopf bifurcation singularities as examples, and give a generic scheme to approximate the center manifolds in both cases of singularities (Hopf, Bogdanov-Takens, Hopf-Hopf, ..).

The lecture notes written by Professor Hans-Otto Walther are composed of two independent parts: the first part deals with the geometry of the attractor of the dynamical system defined by a scalar delay differential equation with monotone feedback. Both a negative and a positive feedback were envisaged by Walther and his coworkers. In collaboration with Dr. Tibor Krisztin, from the University of Szeged, Hungary, and Professor Jianhong Wu, Fields Institute, Toronto, Canada, very detailed global results on the geometric nature of the attractor and the flow along the attractor were found. These results have been obtained within the past ten years or so and are presented in a number of articles and monographs, the last one being more than 200 pages long. The course could only give a general idea of the general procedure that was followed in proving those results and was mainly intended to elicit the interest of participants. The second part of Walther's lecture notes is devoted to a presentation of very recent results obtained by Walther in the study of state-dependent delay differential equations.

The lectures notes by Professors O. Arino, K. Ezzinbi and M. Adimy, and L. Maniar present approaches along the line of the semigroup theory. These lectures prolong in the framework of infinite dimension the presentations made during the first part by Ait Dads and Kappel in the case of finite dimensions. Altogether, they constitute a state of the art of the treatment of the Cauchy problem in the frame of linear functional differential equations. The equations under investigation range from delay differential equations defined by a bounded "delay" operator to equations in which the "delay" operator has a domain which is only part of a larger space (it may be for example the sum of the Laplace operator and a bounded operator), to neutral type equations in which the delay appears also in the time derivative, to infinite delay, both in the autonomous and the non autonomous cases. The methods presented range from the classical theory of strongly continuous semigroups to extrapolation theory, also including the theory of integrated semigroups and the theory of perturbation by duality. Adimy and Ezzinbi dealt with a general neutral equation perturbed by the Laplace operator. Arino presented a theory, elaborated in collaboration with Professor Eva Sanchez, which extends to infinite dimensions the classical linear theory, as it is treated in the monograph by Hale and Lunel.

In his lecture notes, S. Ruan provides a thorough review of models involving delays in ecology, pointing out the significance of the delay.

Most of his concern is about stability, stability loss and the corresponding changes in the dynamical features of the problem. The methods used by Ruan are those developed by Faria and Magalhaes in a series of papers, which have been extensively described by Faria in her lectures. Dr. J. Arino discusses the issue of delay in models of epidemics.

Various aspects of the theory of delay differential equations are presented in this book, including the Cauchy problem, the linear theory in finite and in infinite dimensions, semilinear equations. Various types of functional differential equations are considered in addition to the usual DDE: neutral delay equations, equations with delay dependent upon the starter, DDE with infinite delay, stochastic DDE, etc. The methods of resolution covered most of the currently known ones, starting from the direct method, the semigroup approach, as well as the integrated semigroup or the so-called sun-star approach. The lecture notes touched a variety of issues, including the geometry of the attractor, the Hopf and Bogdanov-Takens singularities. All this however is just a small portion of the theory of DDE. We might name many subjects which haven't been or have just been briefly mentioned in lectures notes: the second Lyapunov method for the study of stability, the Lyapunov-Razumikin method briefly alluded to in the introductory lectures by Hale, the theory of monotone (with respect to an order relation) semi flows for DDE which plays an important role in applications to ecology (cooperative systems) was considered only in the scalar case (the equation with positive feedback in Walther's course). The prolific theory of oscillations for DDE was not even mentioned, nor the DDE with impulses which are an important example in applications. The Morse decomposition, just briefly reviewed the "structural stability" approach, of fundamental importance in applications where it notably justifies robustness of model representations, a breakthrough accomplished during the 1985-1995 decade by Mallet-Paret and coworkers is just mentioned in Walther's course. Delay differential equations have become a domain too wide for being covered in just one book.

Chapter 1

HISTORY OF DELAY EQUATIONS

J.K. Hale

Georgia Institute of Technology

Atlanta, USA

hale@math.gatech.edu

Delay differential equations, differential integral equations and functional differential equations have been studied for at least 200 years (see E. Schmitt (1911) for references and some properties of linear equations). Some of the early work originated from problems in geometry and number theory.

At the international conference of mathematicians, Picard (1908) made the following statement in which he emphasized the importance of the consideration of hereditary effects in the modeling of physical systems:

Les équations différentielles de la mécanique classique sont telles qu'il en résulte que le mouvement est déterminé par la simple connaissance des positions et des vitesses, c'est-à-dire par l'état à un instant donné et à l'instant infiniment voisin.

Les états antérieurs n'y intervenant pas, l'hérédité y est un vain mot. L'application de ces équations où le passé ne se distingue pas de l'avenir, où les mouvements sont de nature réversible, sont donc inapplicables aux êtres vivants.

Nous pouvons rêver d'équations fonctionnelles plus compliquées que les équations classiques parce qu'elles renfermeront en outre des intégrales prises entre un temps passé très éloigné et le temps actuel, qui apporteront la part de l'hérédité.

Volterra (1909), (1928) discussed the integrodifferential equations that model viscoelasticity. In (1931), he wrote a fundamental book on the role of hereditary effects on models for the interaction of species.

The subject gained much momentum (especially in the Soviet Union) after 1940 due to the consideration of meaningful models of engineering

systems and control. It is probably true that most engineers were well aware of the fact that hereditary effects occur in physical systems, but this effect was often ignored because there was insufficient theory to discuss such models in detail.

During the last 50 years, the theory of functional differential equations has been developed extensively and has become part of the vocabulary of researchers dealing with specific applications such as viscoelasticity, mechanics, nuclear reactors, distributed networks, heat flow, neural networks, combustion, interaction of species, microbiology, learning models, epidemiology, physiology, as well as many others (see Kolmanovski and Myshkis (1999)).

Stochastic effects are also being considered but the theory is not as well developed.

During the 1950's, there was considerable activity in the subject which led to important publications by Myshkis (1951), Krasovskii (1959), Bellman and Cooke (1963), Halanay (1966). These books give a clear picture of the subject up to the early 1960's.

Most research on functional differential equations (FDE) dealt primarily with linear equations and the preservation of stability (or instability) of equilibria under small nonlinear perturbations when the linearization was stable (or unstable). For the linear equations with constant coefficients, it was natural to use the Laplace transform. This led to expansions of solutions in terms of the eigenfunctions and the convergence properties of these expansions.

For the stability of equilibria, it was important to understand the extent to which one could apply the second method of Lyapunov (1891). The genesis of the modern theory evolved from the consideration of the latter problem.

In these lectures, I describe a few problems for which the method of solution, in my opinion, played a very important role in the modern analytic and geometric theory of FDE. At the present time, much of the subject can be considered as well developed as the corresponding one for ordinary differential equations (ODE). Naturally, the topics chosen are subjective and another person might have chosen completely different ones.

It took considerable time to take an idea from ODE and to find the appropriate way to express this idea in FDE. With our present knowledge of FDE, it is difficult not to wonder why most of the early papers making connections between these two subjects were not written long ago. However, the mode of thought on FDE at the time was contrary to the new approach and sometimes not easily accepted. A new approach

was necessary to obtain results which were difficult if not impossible to obtain in the classical way.

We begin the discussion with retarded functional differential equations (RFDE) with continuous initial data. If $r \geq 0$ is a given constant, let $C = C([-r, 0], \mathbb{R}^n)$ and, if $x : [-r, \alpha) \rightarrow \mathbb{R}^n$, $\alpha > 0$, let $x_t \in C$, $t \in [0, \alpha)$, be defined by $x_t(\theta) = x(t + \theta)$, $\theta \in [-r, 0]$. If $f : C \rightarrow \mathbb{R}^n$ is a given function, a retarded FDE (RFDE) is defined by the relation

$$x'(t) = f(x_t) \quad (0.1)$$

If $\varphi \in C$ is given, then a solution $x(t, \varphi)$ of (0.1) with initial value φ at $t = 0$ is a continuous function defined on an interval $[-r, \alpha)$, $\alpha > 0$, such that $x_0(\theta) = x(\theta, \varphi) = \varphi(\theta)$ for $\theta \in [-r, 0]$, $x(t, \varphi)$ has a continuous derivative on $(0, \alpha)$, a right hand derivative at $t = 0$ and satisfies (0.1) for $t \in [0, \alpha)$.

We remark that the notation in (0.1) is the modern one and essentially due to Krasovskii (1956), where in (0.1), he would have written $f(x(t + \theta))$ with the understanding that he meant a functional. The notation above was introduced by Hale (1963).

Results concerning existence, uniqueness and continuation of solutions, as well as the dependence on parameters, are essentially the same as for ODE with a few additional technicalities due to the infinite dimensional character of the problem. If f is continuous and takes bounded sets into bounded sets, then there is a solution $x(t, \varphi)$ through φ which exists on a maximal interval $[-r, \alpha_\varphi)$.

Furthermore, if $\alpha_\varphi < \infty$, then the solution becomes unbounded as $t \rightarrow \alpha_\varphi^-$. If f is C^k , then $x(t, \cdot)$ is C^{k+1} and $x(\cdot, \varphi)$ is C^k in φ in $([0, \alpha_\varphi)$.

1. Stability of equilibria and Lyapunov functions

One of the first problems that occurs in differential equations is to obtain conditions for stability of equilibria. Following Lyapunov, it is reasonable to make the following definition.

Definition 1 *Suppose that 0 is an equilibrium point of (0.1); that is, a zero of f . The point 0 is said to be stable if, for any $\varepsilon > 0$, there is a $\delta > 0$ such that for any $\varphi \in C$ with $|\varphi| < \delta$, we have $|x(t, \varphi)| < \varepsilon$ for $t \geq -r$. The point 0 is asymptotically stable if it is stable and there is $b > 0$ such that $|\varphi| < b$ implies that $|x(t, \varphi)| \rightarrow 0$ as $t \rightarrow \infty$. The point 0 is said to be a local attractor if there is a neighborhood U of 0 such that*

$$\lim_{t \rightarrow \infty} \text{dist}(x(t, U), 0) = 0$$

that is, 0 attracts elements in U uniformly.

In this definition, notice that the closeness of initial data is taken in C whereas the closeness of solutions is in \mathbb{R}^n . This is no restriction since, if 0 is stable (resp., asymptotically stable), then $|x_t(\cdot, \varphi)| < \varepsilon$ for $t \geq 0$ (resp. $|x_t(\cdot, \varphi)| \rightarrow 0$ as $t \rightarrow \infty$).

As a consequence of the smoothing properties of solutions of (0.1), one can

use essentially the same proof as for ODE to obtain the following important result.

Proposition 1 *An equilibrium point of (0.1) is asymptotically stable if and only if it is a local attractor.*

For linear retarded equations; that is, $f : C \rightarrow \mathbb{R}^n$ a continuous linear functional, there is a solution of the form $\exp(\lambda t)c$ for some nonzero n -vector c if and only if λ satisfies the characteristic equation

$$\det D(\lambda) = 0, \quad \Delta(\lambda) = \lambda I - f(\exp -\lambda)I. \quad (1.2)$$

The numbers λ are called the eigenvalues of the linear equation. Equation (1.2) may have infinitely many solutions, but there can be only a finite number in any vertical strip in the complex plane. This is a consequence of the analyticity of (1.2) in λ and the fact that $Re\lambda \rightarrow -\infty$ if $|\lambda| \rightarrow \infty$.

The eigenvalues play an important role in stability of linear systems. If there is an eigenvalue with positive real part, then the origin is unstable. For asymptotic stability, it is necessary and sufficient to have each λ with real part < 0 . The verification of this property in a particular example is far from trivial and much research in the 1940's and 1950's was devoted to giving various methods for determining when the λ satisfying (1.2) have real parts < 0 (see Bellman and Cooke (1963) for detailed references).

If the RFDE is nonlinear, if 0 is an equilibrium with all eigenvalues with negative real parts (resp. an eigenvalue with a positive real part), then classical approaches using a variation of constants formula and Gronwall type inequalities can be used to show that 0 is asymptotically stable (resp. unstable) for the nonlinear equation (see Bellman and Cooke (1963)).

If the RFDE is nonlinear and 0 is an equilibrium and the zero solution of the linear variational equation is not asymptotically stable and there is no eigenvalue with positive real part, then classical methods give no information. In this case, it is quite natural to attempt to adapt the well known methods of Lyapunov to RFDE.

Two independent approaches to this problem were given in the early 1950's by Razumikhin (1956) and Krasovskii (1956).

The approach of Razumikhin (1956) was to use Lyapunov functions on \mathbb{R}^n . Let us indicate a few details. If $V : \mathbb{R}^n \rightarrow \mathbb{R}$ is a given continuously differentiable function and $x(t, \varphi)$ is a solution of (0.1), we can define $V(x(t, \varphi))$ and compute the derivative along the solution evaluated at $\varphi(0)$ as

$$\dot{V}(\varphi(0)) = \frac{\partial V(\varphi(0))}{\partial x} f(\varphi) \equiv G(\varphi). \quad (1.3)$$

If the RFDE is not an ODE, then the function $\dot{V}(\varphi(0))$ is not a function from \mathbb{R}^n to \mathbb{R} , but is a function from C to \mathbb{R} . As a consequence, we cannot expect that the derivative in (1.3) is negative for all small initial data φ .

To use such a method, one must consider a restricted set of initial data which is relevant for the consideration of stability.

To illustrate how such conditions arise in a natural way, consider the example

$$x'(t) = -ax(t) - bx(t-r) \quad (1.4)$$

where $a > 0$ and b are constants. If we chose $V(x) = x^2/2$, then V is positive definite from \mathbb{R} to \mathbb{R} and

$$V'_{1.4}(x(t, \varphi)) = -ax^2(t) - bx(t)x(t-r) \quad (1.5)$$

If we knew that the right hand side of (1.5) were ≤ 0 , then we would know that the zero solution of (1.4) is stable. Of course, this can never be true for all functions in C in a neighborhood of zero. On the other hand, if 0 is not stable, then there is an $\varepsilon > 0$ such that, for any $0 < \delta < \varepsilon$, there is a function φ with norm $< \delta$ and a time $t_1 > 0$ such that $|x(t_1, \varphi)| = \varepsilon$ and $|x(t+\theta, \varphi)| < \varepsilon$ for all $\theta \in [-r, 0)$. As a consequence of this remark, it is only necessary to find conditions on b for which the right hand side of (1.4) is ≤ 0 for those functions with the property that $|\varphi| \leq |\varphi(0)|$. It is clear that this can be done if $|b| \leq a$. Therefore, 0 is stable if $|b| \leq a$, $a > 0$. The origin is not asymptotically stable if $a + b = 0$ since 0 is an eigenvalue. We remark that this region in (a, b) -space coincides with the region for which the origin of (1.4) is stable independent of the delay. We have seen that it belongs to this region, but to show that it coincides with this region requires more effort (see, for example, Bellman and Cooke (1963) or Hale and Lunel (1993)).

In this example, it is possible to show that all eigenvalues have negative real parts if $|b| < a$, $a > 0$. Is it possible to use the Lyapunov function $V(x) = x^2/2$ to prove this? For asymptotic stability, we must show that $\dot{V}(\varphi(0)) < 0$ for a class of functions which at least includes functions with the property that $|\varphi| > |\varphi(0)|$. It can be shown that it is sufficient to have the class satisfy $|\varphi| \leq p|\varphi(0)|$ for some constant $p > 1$.

Razumikhin (1956) gave general results in the spirit of the above example to obtain sufficient conditions for stability and asymptotic stability using functions on \mathbb{R}^n .

Theorem 1 (Razumikhin) *Suppose that $u, v, w: [0, \infty) \rightarrow [0, \infty)$ are continuous nondecreasing functions, $u(s), v(s)$ positive for $s > 0$, $u(0) = v(0) = 0$, v strictly increasing. If there is a continuous function $V: \mathbb{R}^n \rightarrow \mathbb{R}$ such that $u(|x|) \leq V(x) \leq v(|x|)$, $x \in \mathbb{R}^n$, and $\dot{V}(\varphi(0)) \leq w(|\varphi(0)|)$, if $V(\varphi(\theta)) \leq V(\varphi(0))$, $\theta \in [-r, 0]$, then the point 0 is stable. In addition, if there is a continuous nondecreasing function $p(s) > s$ for $s > 0$ such that*

$$\dot{V}(\varphi(0)) \leq w(|\varphi(0)|) \text{ if } V(\varphi(\theta)) \leq p(V(\varphi(0))), \theta \in [-r, 0],$$

then 0 is asymptotically stable.

At about the same time as Razumikhin, Krasovskii (1956) was also discussing stability of equilibria and wanted to make sure that all of the results for ODE using Lyapunov functions could be carried over to RFDE. The idea now seems quite simple, but, at the time, it was not the way in which FDE were being discussed.

The state space for FDE should be the space C since this is the amount of information that is needed to determine a solution of the equation. This is the observation made by Krasovskii (1956). He was then able to extend the complete theory of Lyapunov by using functionals $V: C \rightarrow \mathbb{R}$. We state a result on stability.

Theorem 2 . (Krasovskii) *Suppose that $u, v, w: [0, \infty) \rightarrow [0, \infty)$ are continuous nonnegative nondecreasing functions, $u(s), v(s)$ positive for $s > 0$, $u(0) = v(0) = 0$. If there is a continuous function $V: C \rightarrow \mathbb{R}$ such that*

$$u(|\varphi(0)|) \leq V(\varphi) \leq v(|\varphi|), \varphi \in C,$$

$$\dot{V}(\varphi) = \limsup_{t \rightarrow 0} \frac{1}{t} [V(x_t(\cdot, \varphi)) - V(\varphi)] \leq -w(|\varphi(0)|)$$

then 0 is stable. If, in addition, $w(s) > 0$ for $s > 0$, then 0 is asymptotically stable.

Let us apply the Theorem of Krasovskii to the example (1.4) with

$$V(\varphi) = \frac{1}{2} \varphi^2(0) + \mu \int_{-r}^0 \varphi^2(\theta) d\theta,$$

where μ is a positive constant. A simple computation shows that

$$\dot{V}(\varphi) = -(a - \mu) \varphi^2(0) - b \varphi(0) \varphi(-r) - \mu \varphi^2(-r).$$

The right hand side of this equation is a quadratic form in $(\varphi(0), \varphi(-r))$. If we find the region in parameter space for which this quadratic form is nonnegative, then the origin is stable. If it positive definite, then it is asymptotically stable. The condition for nonnegativeness is $a \geq \mu > 0$, $4(a - \mu)\mu \geq b^2$ and positive definiteness if the inequalities are replaced by strict inequalities. To obtain the largest region in the (a, b) space for which these relations are satisfied, we should choose $\mu = a/2$, which gives the region of stability as $a \geq |b|$ and asymptotic stability as $a > |b|$, which is the same result as before using Razumikhin functions.

For more details, generalizations and examples, see Hale and Lunel (1993), Kolmanovski and Myshkis (1999).

2. Invariant Sets, Omega-limits and Lyapunov functionals.

The suggestion made by Krasovskii that one should exploit the fact that the natural state space for RFDE should be C opened up the possibility of obtaining a theory of RFDE which would be as general as that available for ODE. Following this idea, Shimanov (1959) gave some interesting results on stability when the linearization has a zero eigenvalue. This could not have been done without working in the phase space C and exploiting some properties of linear systems which will be mentioned later.

I personally had been thinking about delay equations in the 1950's and reading the RAND report of Bellman and Danskin (1954). The methods there did not seem to be appropriate for a general development of the subject. In 1959, it was a revelation when Lefschetz gave me a copy of Krasovskii's book (in Russian). I began to work very hard to try to obtain interesting results for RFDE on concepts which were well known to be important for ODE. My first works were devoted to understanding the neighborhood of an equilibrium point (stable and unstable manifolds) and to defining invariant sets in a way that could be useful for applications.

In the present section, it is best to describe invariance since the first important application was related to stability. For simplicity, let us suppose that, for every $\varphi \in C$, the solution $x(t, \varphi)$ through $\varphi \in C$ at $t = 0$ is defined for all $t \geq 0$. If we define the family of transformations $T(t) : C \rightarrow C$ by the relation $T(t)\varphi = x_t(., \varphi)$, $t \geq 0$, then $\{T(t), t \geq 0\}$ is a semigroup on C ; that is

$$T(0) = I, \quad T(t + \tau) = T(t)T(\tau), \quad t, \tau \geq 0.$$

The smoothness of $T(t)\varphi$ in φ is the same as the smoothness of f and, for $t \geq r$, $T(t)$ is a completely continuous operator since, for each φ , the solution $x(t, \varphi)$ is differentiable for $t \geq r$.

Definition 2 : The positive orbit $\gamma^+(\varphi)$ through φ is the set $\{T(t)\varphi, t \geq 0\}$.

A set $A \subset C$ is an invariant set for $T(t)$, $t \geq 0$, if $T(t)A = A$, $t \geq 0$.

The ω -limit set of $\varphi \in C$, denoted by $\omega(\varphi)$, is

$$\omega(\varphi) = \bigcap_{\tau \geq 0} Cl(\gamma^+(T(\tau)\varphi)).$$

The ω -limit set of a subset B in C , denoted by $\omega(B)$, is

$$\omega(B) = \bigcap_{\tau \geq 0} Cl\gamma^+(T(\tau)B).$$

Note that a function $\psi \in \omega(\varphi)$ if and only if there is a sequence $t_n \rightarrow \infty$ as $n \rightarrow \infty$ such that $T(t_n)\varphi \rightarrow \psi$ as $n \rightarrow \infty$. A function $\psi \in \omega(B)$ if and only if there exist sequences $\{\varphi_n, n = 1, 2, \dots\} \subset B$ and $t_n \rightarrow \infty$ as $n \rightarrow \infty$ such that $T(t_n)\varphi_n \rightarrow \psi$ as $n \rightarrow \infty$. We remark that $\omega(B)$ may not be equal to $\bigcup_{\varphi \in B} \omega(\varphi)$. This is easily seen from the ODE $x' = x - x^3$, $x \in \mathbb{R}$.

If A is invariant, then, for any $\varphi \in A$, there is a preimage and, thus, it is possible to define negative orbits through φ . This is not possible for all $\varphi \in C$ since a solution of (0.1) becomes continuously differentiable for $t \geq r$. Also, there may not be a unique negative orbit through $\varphi \in A$.

A set A in C attracts a set B in C if $dist(T(t)B, A) \rightarrow 0$ as $t \rightarrow \infty$.

The following result is consequence of the fact that $T(r)$ is completely continuous.

Theorem 3 : If $B \subset C$ is such that $\gamma^+(B)$ is bounded, then $\omega(B)$ is a indexcompact invariant set which attracts B under the flow defined by (0.1) and is connected if B is connected.

The following result is a natural generalization of the classical LaSalle invariance principle for ODE.

Theorem 4 : (Hale, 1963) Let V be a continuous scalar function on C with $\dot{V}(\varphi) \leq 0$ for all $\varphi \in C$. If $U_a = \{\varphi \in C : V(\varphi) \leq a\}$, $W_a = \{\varphi \in U_a : \dot{V}(\varphi) = 0\}$ and M is the maximal invariant set in W_a , then, for any $\varphi \in U_a$ for which $\gamma^+(\varphi)$ is bounded, we have $\omega(\varphi) \subset M$.

If U_a is a bounded set, then $M = \omega(U_a)$ is compact invariant and attracts U_a under the flow defined by (0.1). If U_a is connected, so is M .

To the author's knowledge, these concepts for RFDE were first introduced in Hale (1963) and were used to give a simple proof of convergence for the Levin-Nohel equation

$$x'(t) = -\frac{1}{r} \int_{-r}^0 a(-\theta)g(x(t + \theta))d\theta \tag{2.6}$$

where the zeros of g are isolated and

$$G(x) = \int_0^x g(s)ds \rightarrow \infty \text{ as } |x| \rightarrow \infty$$

$$a(r) = 0, a \geq 0, \dot{a} \leq 0, \ddot{a} \geq 0.$$

Theorem 5 *∴ (Levin-Nohel) 1). If a is not a linear function, then, for any $\varphi \in C$, $\omega(\varphi)$ is a zero of g .
 2). If a is a linear function, then, for any $\varphi \in C$, $\omega(\varphi)$ is an r -periodic orbit in C defined by an r -periodic solution of the ODE*

$$y'' + g(y) = 0.$$

We outline the proof of Hale (1963) which is independent of the one given by Levin and Nohel. However, we will use their clever choice of a Lyapunov function. If

$$V(\varphi) = G(\varphi(0)) - \frac{1}{2} \int_{-r}^0 a'(-\theta) \left[\int_{\theta}^0 g(\varphi(s))ds \right]^2 d\theta,$$

then the derivative of V along the solutions of (2.6) is given by

$$\dot{V}(\varphi) = \frac{1}{2} a'(r) \left[\int_{-r}^0 g(\varphi(s))ds \right]^2 - \frac{1}{2} \int_{-r}^0 a''(-\theta) \int_{\theta}^0 g(\varphi(s))ds \int_{\theta}^0 g(\varphi(s))ds d\theta.$$

The hypotheses imply that $\dot{V}(\varphi) \leq 0$ and $\gamma^+(\varphi)$ is bounded for each $\varphi \in C$.

To apply the above theorem, we need to investigate the set where $\dot{V} = 0$. To do this, we observe that any solution of (2.6) also must satisfy the equation

$$x''(t) + a'(0)g(x(t)) = -a'(r) \int_{-r}^0 g(\varphi(s))ds + \int_{-r}^0 a''(-\theta) \left[\int_{\theta}^0 g(\varphi(s))ds \right] d\theta.$$

With this relation and the fact that $\dot{V}(\varphi) \leq 0$, we see that the largest invariant set in the set where $\dot{V} = 0$ coincides with those bounded solutions of the equation

$$y'' + g(y) = 0.$$

which satisfy the property that

$$\begin{aligned} \int_{-r}^0 g(y(t+\theta))d\theta &= 0, \quad t \in \mathbb{R}, \text{ if } a'(r) \neq 0, \\ \int_{-s}^0 g(y(t+\theta))d\theta &= 0, \quad t \in \mathbb{R}, \text{ if } a''(s) \neq 0 \end{aligned} \quad (2.7)$$

If a is not a linear function, then there is an s_0 such that $a''(s_0) \neq 0$ and there is an interval I_{s_0} of s_0 such that $a''(s) \neq 0$ for $s \in I_{s_0}$.

Integrating the second order ODE from $-s$ to 0 and using (2.7), we observe that y is periodic of period s for every $s \in I_{s_0}$. Thus, y is a constant and $\omega(\varphi)$ belongs to the set of zeros of g . Since the zeros of g are isolated and $\omega(\varphi)$ is connected, we have the conclusion in part 1 of the theorem.

If a is a linear function, then we must be concerned with the solutions of the ODE for which $\int_{-r}^0 g(y(t+\theta))d\theta = 0$. As before, this implies that y' is periodic of period r and there is a constant k such that $y(t) = kt + (\text{a periodic function of period } r)$. Boundedness of y implies that $y(t)$ is r -periodic. This shows that $\omega(\varphi)$ belongs to the set of periodic orbits generated by r -periodic solutions of the ODE. To prove that the ω -limit set is a single periodic orbit requires an argument using techniques in ODE which we omit.

3. Delays may cause instability.

In his study of the control of the motion of a ship with movable ballast, Minorsky (1941) (see also Minorsky (1962)) made a realistic mathematical model which contained a delay (representing the time for the readjustment of the ballast) and observed that the motion was oscillatory if the delay was too large. An equation was also encountered in prime number theory by Wright (1955) which had the same property.

It was many years later that S. Jones (1962) gave a procedure for determining the existence of a periodic solution of delay differential equations which has become a standard tool in this area. I describe this for the equation of Wright

$$x'(t) = -\alpha x(t-1)(1+x(t)), \quad (3.8)$$

where $\alpha > 0$ is a constant.

The equation (3.8) has two equilibria $x = 0$ and $x = -1$. The set $C_{-1} = \{\varphi \in C : \varphi(0) = -1\}$ is the translation of a codimension one subspace of C and is invariant under the flow defined by (3.8). Furthermore, any solution with initial data in C_{-1} is equal to the constant function -1 for $t \geq 1$. The linear variational equation about $x = -1$ has only the eigenvalue $\alpha > 0$ and is, therefore, unstable.

The set C_{-1} serves as a natural barrier for the solutions of (3.8). In fact, if a solution has initial data φ for which $\varphi(0) \neq -1$, then the solution $x(t) \neq -1$ for all $t \geq 0$ for which it is defined. In fact, if $x(t)$ is a solution of (3.8) through a point $\varphi \in C$ with $\varphi(0) \neq -1$, then, for any t_0 for which $x(t_0) \neq -1$ and any $t \geq t_0$,

$$1 + x(t) = [1 + x(t_0)] \exp(-\alpha \int_{t_0-1}^{t-1} x(s) ds) \tag{3.9}$$

This proves the assertion.

The sets $C_- = \{\varphi \in C : \varphi(0) < -1\}$ and $C_+ = \{\varphi \in C : \varphi(0) > -1\}$ are positively invariant under the flow defined by (3.18). If $\varphi \in C_-$, it is not difficult to show that $x(t, \varphi) \rightarrow -\infty$ as $t \rightarrow \infty$.

As a consequence of these remarks, we discuss this equation in the subset C_+ of C .

If $\varphi \in C_+$, then (3.9) shows that a solution $x(t)$ cannot become unbounded on a finite interval, each solution exists for all $t \geq 0$ and (3.8) defines a semigroup $T_\alpha(t) : C_+ \rightarrow C_+$, $t \geq 0$, where $T_\alpha(t)\varphi = x_t(\cdot, \varphi)$. It also is clear that $T_\alpha(t)$ is a bounded map for each $t \geq 0$.

It is possible to show that, for each $\varphi \in C_+$, there is a $t_0(\varphi, \alpha)$ such that $|T_\alpha(t)\varphi| \leq \exp \alpha - 1$ for $t \geq t_0(\varphi, \alpha)$. As a consequence of some later remarks, this implies the existence of the compact global attractor A of (3.8); that is, A is compact, invariant and attracts bounded sets of C .

Wright (1955) proved that every solution approaches zero as $t \rightarrow \infty$ if $0 < \alpha < \exp(-1)$ and this implies that $\{0\}$ is the compact global attractor for (3.8). Yorke (1970) extended this result (even for more general equations) to the interval $0 < \alpha < 3/2$.

The eigenvalues of the linearization about zero of (3.8) are the solutions of the equation, $\lambda + \alpha \exp(-\lambda) = 0$. The eigenvalues have negative real parts for $0 < \alpha < \frac{\pi}{2}$, a pair of purely imaginary eigenvalues for $\alpha = \frac{\pi}{2}$ with the remaining ones having negative real parts and, For $\alpha > \frac{\pi}{2}$, there is a unique pair of eigenvalues with maximal real part > 0 .

It is reasonable to conjecture that $A = \{0\}$ for $0 < \alpha < \frac{\pi}{2}$, but this has not been proved. On the other hand, there is the following interesting result.

Theorem 6 : (Jones (1962)) *If $\alpha > \frac{\pi}{2}$, equation (3.8) has a periodic solution oscillating about 0 and with the property that the distance between zeros is greater than the delay.*

We indicate the ideas in the original proof of Jones (1962). Numerical computations suggested that there should be such a solution with simple

zeros and the distance from a zero to the next maximum (or minimum) is \geq the delay. Let $K \subset C$ be defined as $K = Cl\{\text{nondecreasing functions } \varphi \in C: \varphi(-1) = 0, \varphi(\theta) > 0, \theta \in (-1, 0]\}$

$T_\alpha(t_1)\varphi \in K$. This defines a Poincaré map $P_\alpha: \varphi \in K$ maps to $T_\alpha(t_1)\varphi \in K$ if we define $P_\alpha 0 = 0$.

One can show that this map is completely continuous.

A nontrivial fixed point of P_α yields a periodic solution of (3.18) with the properties stated in the above theorem. The main difficulty in the proof of the theorem is that $0 \in K$ is a fixed point of P_α and one wants a nontrivial fixed point. The point $0 \in K$ is unstable and Jones was able to use this to show eventually that he could obtain the desired fixed point from Schauder's fixed point theorem.

Many refinements have been made of this method using interesting ejective fixed point theorems (which were discovered because of this problem) (see Browder (1965), Nussbaum (1974)). In the above problem, the point 0 is ejective. Grafton (1969) showed that the use of unstable manifold theory could be of assistance in the verification of ejectivity. See, for example, Hale and Lunel (1993), Diekmann, van Giles, Lunel and Walther (1991).

4. Linear autonomous equations and perturbations.

Prior to Krasovskii, and even after, most researchers discussed linear autonomous equations and perturbations of such equations by considering properties of the solution $x(t, \varphi)$ in \mathbb{R}^n . Such an approach limits the extent to which one can obtain many of the interesting properties that are similar to the ones for ODE.

In the approach of Krasovskii, a linear autonomous equation generates a C^0 -semigroup on C which is compact for $t \geq r$. Therefore, the spectrum is only point spectrum plus possibly 0. The infinitesimal generator has compact resolvent with only point spectrum. The point spectrum of the generator determines the point spectrum of the semigroup by exponentiation. This suggests a decomposition theory into invariant subspaces similar to ones used for ODE. Shimanov (1959) exploited this fact to discuss the stability of an equilibrium point for a nonlinear equation for which the linear variational equation had a simple zero eigenvalue and the remaining ones had negative real parts. The complete theory of the linear case was developed by Hale (1963) (see also Shimanov (1965)).

Since linear equations are to be discussed in detail in this summer workshop, we are content to give only an indication of the results with a few applications.

Consider the equation

$$x'(t) = Lx_t, \tag{4.10}$$

where $L : C \rightarrow \mathbb{R}^n$ is a bounded linear operator. Equation (4.10) generates a C^0 -semigroup $T_L(t), t \geq 0$, on C which is completely continuous for $t \geq r$. Therefore, the spectrum $\sigma(T_L(t))$ consists only of point spectrum $\sigma_p(T_L(t))$ plus possible zero.

The infinitesimal generator A_L is easily shown to be given by

$$D(A_L) = \{\varphi \in C^1([-r, 0], \mathbb{R}^n) : \varphi'(0) = L\varphi\}, \quad A_L\varphi = \varphi' \tag{4.11}$$

The operator A_L has compact resolvent and the spectrum is given

$$\sigma(A_L) = \{\lambda : \mathfrak{z}(\lambda) = 0\}, \quad \mathfrak{z}(\lambda) = \lambda I - L \exp(\lambda \cdot) I. \tag{4.12}$$

In any vertical strip in the complex plane, there are only a finite number of elements of $\sigma(A_L)$. If $\lambda \in \sigma(A_L)$, then the generalized eigenspace M_λ of λ is finite dimensional, say of dimension d_λ . If $\phi_\lambda = (\varphi_1, \dots, \varphi_{d_\lambda})$ is a basis for M_λ , then there is a $d_\lambda \times d_\lambda$ matrix B_λ such that

$$A_L\phi = \phi B_\lambda, \quad [\phi] = M_\lambda,$$

where $[\phi]$ denotes span.

From the definition of A_L , it is easily shown that M_λ is invariant under $T_L(t)$ and

$$T_L(t)\phi = \phi \exp(B_\lambda t), \quad t \in \mathbb{R}.$$

There is a complementary subspace $M_\lambda^\perp \subset C$ of M_λ such that

$$C = M_\lambda \oplus M_\lambda^\perp, \quad T_L(t)M_\lambda^\perp \subset M_\lambda^\perp, \quad t \geq 0, \tag{4.13}$$

Of course, such a decomposition can be applied to any finite set of elements of $\sigma(A_L)$.

In applications of this decomposition theory, it is necessary to have a specific computational method to construct the complementary subspace. This was done in detail by using an equation which is the ‘adjoint’ of (4.10) (see, for example, Hale (1963), Shimanov (1965), Hale (1977), Hale and Lunel (1993), Diekmann, van Giles, Lunel and Walther (1991)).

Consider now a perturbed linear system

$$x'(t) = Lx_t + f(t), \tag{4.14}$$

where $f : \mathbb{R} \rightarrow \mathbb{R}^n$ is a continuous function. In ODE, the variation of constants formula plays a very important role in understanding the effects of f on the dynamics. For RFDE, a variation of constants formula is implicitly stated in Bellman and Cooke (1963), Halanay (1965). It is

not difficult to show that there is a solution $X(t) = X(t, X_0)$ of (4.10) through the $n \times n$ discontinuous matrix function X_0 defined by

$$X_0(\theta) = 0, \theta \in [-r, 0), X_0(0) = I, \theta = 0. \quad (4.15)$$

With this function $X(t)$ and defining $X_t = T(t)X_0$, it can be shown that the solution $x(t) = x(t, \varphi)$ of (4.14) through φ is given by

$$x_t = T(t)\varphi + \int_0^t T(t-s)X_0 f(s)ds, t \geq 0. \quad (4.16)$$

The equation (4.16) is not a Banach integral. For each $\theta \in [-r, 0]$, the equation (4.16) is to be interpreted as an integral equation in \mathbb{R}^n .

The equation (4.16), interpreted in the above way, was used in the development of many of the first fundamental results in RFDE (see, for example, Hale (1977)). The Banach space version of the variation of constants formula makes use of sun-reflexive spaces and there also is a theory based on integrated semigroups (see Diekmann, van Giles, Lunel and Walther (1991) for a discussion and references).

With (4.16) and the above decomposition theory, it is possible to make a decomposition in the variation of constants formula. We outline the procedure and the reader may consult Hale (1963), (1977) or Hale and Lunel (1993) for details.

Let $x(t) = x(t, \varphi)$ be a solution of (4.14) with initial value φ at $t = 0$, choose an element $\lambda \in \sigma(A_L)$ and make the decomposition as in (4.13), letting

$$\varphi = \varphi_\lambda + \varphi_\lambda^\perp X_0 = X_{0,\lambda} + X_{0,\lambda}^\perp, x_t = x_{t,\lambda} + x_{t,\lambda}^\perp \quad (4.17)$$

The decomposition on X_0 needs to be and can be justified.

If we apply this decomposition to (4.16), we obtain the equations

$$\begin{aligned} x_{t,\lambda} &= T_L(t)\varphi_\lambda + \int_0^t T(t-s)X_{0,\lambda} f(s)ds \\ x_{t,\lambda}^\perp &= T_L(t)\varphi_\lambda^\perp + \int_0^t T(t-s)X_{0,\lambda}^\perp f(s)ds \end{aligned} \quad (4.18)$$

If we use the fact that $T_\lambda(t)\phi_\lambda = \phi \exp(B_\lambda t)$ and let $x_{t,\lambda} = \phi y(t)$, and, for simplicity in notation, $x_{t,\lambda}^\perp = z_t$, then we have

$$\begin{aligned} y(t) &= \exp(B_\lambda t)a + \int_0^t \exp B_\lambda(t-s)K f(s)ds \\ z_t &= T_L(t)z_0 + \int_0^t T(t-s)X_{0,\lambda}^\perp f(s)ds \end{aligned} \quad (4.19)$$

where $a = y(0)$ and $X_{0,\lambda} = \phi K$ with K being a $d_\lambda \times d_\lambda$ matrix. The first equation in (4.19) is equivalent to an ODE

$$y' = B_\lambda y + Kf(t) \quad (4.20)$$

with $y(0) = a$.

At the time that this decomposition in C was given for the nonhomogeneous equation, it was not readily accepted by many people that were working on RFDE. The main reason was that we now have the solution expressed as two variable functions $\phi y(t)$ and z_t of t and, if $f \neq 0$, then neither of these functions can be represented by functions of $t + \theta$, $\theta \in [-r, 0]$. Therefore, neither function can satisfy an RFDE. Their sum yields a function x_t which does satisfy this property.

In spite of the apparent discrepancy, it is precisely this type of decomposition that permits us to obtain qualitative results similar to the ones in ODE. The first such result was given by Hale and Perello (1964) when they defined the stable and unstable sets for an equilibrium point and proved the existence and regularity of the local stable and unstable manifolds of an equilibrium for which no eigenvalues lie on the imaginary axis; that is, they proved that the saddle point property was valid for hyperbolic equilibria. The proof involved using Lyapunov type integrals to obtain each of these manifolds as graphs in C (see, for example, Hale (1977), Hale and Lunel (1993) or Diekmann, van Giles, Lunel and Walther (1991)). We now know that further extensions give a more complete description of the neighborhood of an equilibrium including center manifolds, foliations, etc.

Another situation that was of considerable interest in the late 1950's and 1960's was the consideration of perturbed systems of the form

$$x'(t) = Lx_t + M(t, x_t), \quad (4.21)$$

where, for example, $M(t, \varphi)$ is continuous and linear in φ and there is a function $a(t)$ such that

$$|M(t, \varphi)| \leq a(t)|\varphi|, \quad t \geq 0, \quad (4.22)$$

and the function a is small in some sense. The problem is to determine conditions on a to ensure that the behavior of solutions of (4.21) are similar to the solutions of (4.10).

For example, Bellman and Cooke (1959) considered the following problem. Suppose that α is a scalar, λ is an eigenvalue of (4.10) and there are no other eigenvalues with the same real parts. Determine conditions on a so that there is a solution of (4.21) which asymptotically as $t \rightarrow \infty$ behaves as the solution $\exp \lambda t$ of (4.10). Their approach was to replace

a solution $x(t)$ of (4.14) by a function $w(t) \in \mathbb{R}^n$ by the transformation $x(t) = (\exp \lambda t) w(t)$ in \mathbb{R}^n . In this case, the function $w(t)$ will satisfy a RFDE and the problem is to show that $w(t) \rightarrow 0$ as $t \rightarrow \infty$. In the case where $a(t) \rightarrow 0$ as $t \rightarrow \infty$ and $\int_0^\infty |a(t)| dt$ may be ∞ , it was necessary to impose several additional conditions on a to ensure that $w(t) \rightarrow 0$ as $t \rightarrow \infty$. Some of these conditions seemed to be artificial and were not needed for ODE.

Another way to solve this type of problem is to make the transformation in C given by $x_t = \exp(\lambda t) z_t$ and determine conditions on z_t so that $z_t \rightarrow 0$ in C as $t \rightarrow \infty$. In this case, the function z_t does not satisfy an RFDE. On the other hand, some of the unnatural conditions imposed by Bellman and Cooke (1959) were shown to be unnecessary (see Hale (1966)).

5. Neutral Functional Differential Equations

Neutral functional differential equations have the form

$$x'(t) = f(x_t, x'_t); \quad (5.23)$$

that is, $x'(t)$ depends not only upon the past history of x but also on the past history of x' . Let X, Y be Banach spaces of functions mapping the interval $[-r, 0]$ into \mathbb{R}^n . We say that $x(t, \varphi, \psi)$ is a solution of (5.23) through $(\varphi, \psi) \in X \times Y$, if $x(t, \varphi, \psi)$ is defined on an interval $[-r, \alpha)$, $\alpha > 0$, $x_0(\cdot, \varphi, \psi) = \varphi$, $x'_0(\cdot, \varphi, \psi) = \psi$ and satisfies (5.23) in a sense consistent with the definitions of the spaces X and Y .

For example, if $X = C([-r, 0], \mathbb{R}^n)$, $Y = L([-r, 0], \mathbb{R}^n)$, then the solution should be continuous with an integrable derivative and satisfy (5.23) almost everywhere.

The proper function spaces depend upon the class of functions f that are being considered. For a general discussion of this point, see Kolmanovskii and Myskis (1999).

From my personal point of view, it is important to isolate classes of neutral equations for which it is possible to obtain a theory which is as complete as the one for the RFDE considered above. Hale and Meyer (1967) introduced such a general class of neutral equations which were motivated by transport problems (for example, lossless transmission lines with nonlinear boundary conditions) and could be considered as a natural generalization of RFDE in the space C . We describe the class and state a few of the important results. The detailed study of this class of equations required several new concepts and methods which have been used in the study of other evolutionary equations (with or without hereditary effects); for example, damped hyperbolic partial dif-

ferential equations and other partial differential equations of engineering and physics.

Suppose that $D, f : C \rightarrow \mathbb{R}^n$ are continuous and D is linear and atomic at 0; that is,

$$D\varphi = \varphi(0) - \int_{-r}^0 [d\mu(\theta)]\varphi(\theta)$$

and the measure μ has zero atom at 0. The equation

$$\frac{d}{dt}Dx_t = f(x_t) \quad (5.24)$$

is called a neutral FDE (NFDE). If $D\varphi = \varphi(0)$, we have RFDE.

For any $\varphi \in C$, a function $x(t, \varphi)$ is said to be a solution of (5.24) through φ at $t = 0$ if it is defined and continuous on an interval $[-r, \alpha)$, $\alpha > 0$, $x_0(\cdot, \varphi) = \varphi$, the function $Dx_t(\cdot, \varphi)$ is continuously differentiable on $(0, \alpha)$ with a right hand derivative at $t = 0$ and satisfies (5.24) on $[0, \alpha]$.

It is important to note that the function $D(x_t(\cdot, \varphi))$ is required to be differentiable and not the function $x(t, \varphi)$.

Except for a few technical considerations, the basic theory of existence, uniqueness, continuation, continuous dependence on parameters, etc. are essentially the same as for RFDE.

As before, if we let $T_{D,f}(t)\varphi = x_t(\cdot, \varphi)$ and suppose that all solutions are defined for all $t \geq 0$, then $T_{D,f}(t)$, $t \geq 0$, is a semigroup on C with $T_{D,f}(t)\varphi$ a C^k -function in φ if f is a C^k -function.

It is easily shown that the infinitesimal generator $A_{D,f}$ of $T(t)$ is given by

$$D(A_{D,f}) = \{\varphi \in C^1([-r, 0], \mathbb{R}^n) : D(\varphi') = f(\varphi), A_{D,f}\varphi = \varphi'\}. \quad (5.25)$$

Hale and Meyer (1967) considered (5.24) when the function f was linear and were interested in the determination of conditions for stability of the origin with these conditions being based upon properties of the generator $A_{D,f}$. It was shown that, if the spectrum of $A_{D,f}$ was uniformly bounded away from the imaginary axis and in the left half of the complex plane, then one could obtain uniform exponential decay rate for solutions provided that the initial data belonged to the domain of $A_{D,f}$. Of course, this should not be the best result and one should get these uniform decay rates for any initial data in C . This was proved by Cruz and Hale (1971), Corollary 4.1, and a more refined result was given by Henry (1974).

Due to the fact that the solutions of a RFDE are differentiable for $t \geq r$, the corresponding semigroup is completely continuous for $t \geq r$.

Such a nice property cannot hold for a general NFDE since the solutions have the same smoothness as the initial data. On the other hand, there is a representation of the semigroup for a NFDE as a completely continuous perturbation of the semigroup generated by a difference equation related to the operator D .

To describe this in detail, suppose that

$$D\varphi = D_0\varphi + \int_{-r}^0 B(\theta)\varphi(\theta)d\theta, \quad D_0\varphi = \sum_{k=0}^{\infty} B_k\varphi(-\rho_k)\varphi(-r_k) \quad (5.26)$$

where $B(\theta)$ is a continuous $n \times n$ matrix, $B_k, k = 0, 1, 2, \dots$ is an $n \times n$ constant matrix, $r_0 = 0, 0 < r_k \leq r, k = 1, 2, \dots$

Let C_{D_0} be the linear subspace of C defined by

$$C_{D_0} = \{\varphi \in C : D_0\varphi = 0\}$$

and let $T_{D_0}(t), t \geq 0$, be the semigroup on C_{D_0} defined by $T_{D_0}(t) = y_t(\cdot, \varphi)$, where $y(t, \varphi)$ is the solution of the difference equation

$$D_0y_t = 0, \quad y_0 = \varphi \in C_{D_0}. \quad (5.27)$$

Theorem 7 : (*Representation of solution operator*) There are a bounded linear operator $\psi: C \rightarrow C_{D_0}$ and a completely continuous operator $U_{D,f}(t) : C \rightarrow C, t \geq 0$, such that

$$T_{D,f}(t) = T_{D_0}(t)\psi + U_{D,f}(t), \quad t \geq 0. \quad (5.28)$$

Using results in Cruz and Hale (1971), the representation theorem was proved in Hale (1970) for the situation where D_0 is an exponentially stable operator. The proof in that paper clearly shows that it is only required that D_0 is an exponentially stable operator. Henry (1974) also gave such a representation of the semigroup for (5.24).

In the statement of the above theorem, there is the mysterious linear operator $\psi : C \rightarrow C_{D_0}$. Let us indicate how it is constructed. For RFDE, $D_0\varphi = \varphi(0)$ and $\psi\varphi = \varphi - \varphi(0)$, which is just a translation of the initial function in order to have $\psi\varphi \in C_{D_0}$. For general D_0 , one first chooses a matrix function $\phi = (\varphi_1, \dots, \varphi_n), \varphi_j \in C, j \geq 1$, so that $D_0(\phi) = I$, the identity and then set $\psi = I - \phi D_0$.

The representation (5.28) shows that the essential spectrum $\sigma_{ess}(T_{D,f}(t))$ of the operator $T_{D,f}(t)$ on C coincides with the essential spectrum $\sigma_{ess}(T_{D_0}(t))$ of $T_{D_0}(t)$ on C_{D_0} . It can be shown (see Henry (1987)) that the spectrum $\sigma(T_{D_0}(t))$ of $T_{D_0}(t)$ coincides with its essen-

tial spectrum and that

$$\sigma_{ess}(T_{D_0}(t)) = Cl \left\{ \exp(\lambda t) : \det \Delta_{D_0}(\lambda) = 0; \Delta_{D_0}(\lambda) = \sum_{k=1}^{\infty} B_k \exp(\lambda r_k) \right\} \quad (5.29)$$

We say that the operator D_0 is exponentially stable if $\sigma(T_{D_0}(t))$ for $t > 0$ is inside the unit circle with center zero in the complex plane. In this case, there are constants $K_{D_0} \geq 1, \alpha_{D_0} > 0$ such that

$$|T_{D_0}(t)\varphi| \leq K_{D_0} \exp -\alpha_{D_0} t, t \geq 0, \varphi \in C_{D_0}. \quad (5.30)$$

As a consequence, there is a constant K_1 such that

$$|T_{D_0}(t)\psi\varphi| \leq K_{D_0} K_1 \exp -\alpha_{D_0} t, t \geq 0, \varphi \in C. \quad (5.31)$$

We remark that, if D_0 is exponentially stable, it is possible to find an equivalent norm in C such that $K_{D_0} K_1 = 1$; that is, $T_{D_0}(t)\psi$ is a strict contraction for each $t > 0$. In this norm, relation (5.28) implies that $T_{D,f}(t)$ is the sum of a strict contraction and a completely continuous operator for each $t > 0$.

For the RFDE, $D\varphi = D_0\varphi = \varphi(0)$ and D_0 is exponential stable since the solutions of the difference equation $x(t) = 0$ on $\{\varphi \in C : \varphi(0) = 0\}$ is identically zero for $t \geq r$ and has the spectrum of the semigroup consisting only of the point 0. This fact implies that the semigroup is compact for $t \geq r$ as we have noted before. The representation (5.28) says more since it gives properties of the semigroup on the interval $[0, r]$ as the sum of an exponentially decaying semigroup and a completely continuous semigroup. We make an application of this later when we discuss periodic solutions of time varying systems with periodic dependence on time.

If $D_0\varphi = \varphi(0) - a\varphi(-r)$, then D_0 is exponentially stable if and only if $|a| < 1$ and $r_{ess}(T_{D_0}(t)) = |a|^t$.

Stability of an equilibrium point of a NFDE is defined in the same way as for RFDE. We remark that, for general NFDE, an equilibrium point being asymptotically stable does not imply that the equilibrium point is a local attractor. In fact, it is possible to have a linear system

$$\frac{d}{dt} Dx_t = Lx_t$$

for which every solution approaches zero as $t \rightarrow \infty$, 0 is stable and is not a local attractor. In this case, the essential spectral radius of the semigroup (and therefore of $T_{D_0}(t)$) must be equal to one for all $t \geq 0$. In fact, if there is a $t_1 > 0$ such that it is less than one, then the above

representation formula implies that, if the solutions approach zero as $t \rightarrow \infty$, then the spectrum of the semigroup for $t > 0$ must be inside the unit circle and 0 would be a local attractor.

The example

$$\frac{d}{dt}[x(t) - ax(t-1)] = -cx(t)$$

with $|a| = 1$ and $c > 0$ has the property just stated. It is an interesting exercise to verify this fact.

Much of the theory for RFDE has been carried over to NFDE if the operator D_0 is exponentially stable. However, there are many aspects that have not yet been explored (see Hale and Lunel (1993), Hale, Magalhaes and Oliva (2002)).

6. Periodically forced systems and discrete dynamical systems.

If X is a Banach space and $T : X \rightarrow X$ is a continuous map, we obtain a discrete dynamical system by considering the iterates $T^n, n \geq 0$, of the map. Positive orbits, ω -limit sets, invariance, etc. are defined the same way as for continuous semigroups.

In the context of the present lectures, we can obtain a discrete dynamical system in the following way. If the RFDE or NFDE is nonautonomous with the time dependence being τ -periodic, we can define the Poincaré map $\pi : C \rightarrow C$ which takes the initial data $\varphi \in C$ to the solution $x_t(\cdot, \varphi)$ at time τ . The map π defines a discrete dynamical system. Fixed points of π correspond to periodic solutions of the equation with the same period as the forcing.

In his study of the periodically forced van der Pol equation, Levinson (1944) attempted to determine the existence of a periodic solution of the same period as the forcing. To do this, he introduced the concept of point dissipativeness described below and was able to use the Brouwer fixed point theorem to prove that some iterate of the Poincaré map had a fixed point, but he could not prove that the map itself had a fixed point.

Massera (1950) gave an example of a 2-dimensional ODE with τ -periodic coefficients which had a 2τ -periodic solution, but did not have a τ -periodic solution. In addition, all solutions were bounded.

This shows that dissipation is necessary if the differential system of Levinson is to have a τ -periodic solution. There was a successful solution to this problem which we describe in the next section.

7. Dissipation, maximal compact invariant sets and attractors.

We have seen above that dissipation can perhaps be beneficial. In many important applications, there is dissipation which forces solutions with large initial data away from infinity; that is, ‘infinity is unstable.’ It is important to understand the implications of such a concept for both autonomous and nonautonomous problems.

In this section, we introduce the new concepts that are needed for continuous dynamical systems defined by a C^0 -semigroup $T(t)$, $t \geq 0$, as well as discrete dynamical systems $\{T^n, n = 0, 1, 2, \dots\}$ defined by a map T on a Banach space X . To write things in a unified way, we let \mathfrak{S}^+ denote either the interval $(-\infty, \infty)$ or the set $Z = \{0, \pm 1, \pm 2, \dots\}$, \mathfrak{S}^+ (resp. \mathfrak{S}^-) the nonnegative (resp. nonpositive) subsets of \mathfrak{S} . We can now write the continuous and discrete dynamical systems with the notation $T(t)$, $t \in \mathfrak{S}^+$.

Definition 3 : (*Dissipativeness*). The semigroup $T(t)$, $t \in \mathfrak{S}^+$ is said to be point dissipative (resp. compact dissipative) (resp. bounded dissipative) if there is a bounded set B in X such that, for any $\varphi \in X$ (resp. compact set K in X) (resp. bounded set U in X), there is a $t_0 = t_0(B, \varphi) \in \mathfrak{S}^+$ (resp. $t_0 = t_0(B, K)$) (resp. $t_0 = t_0(B, U)$) such that $T(t)\varphi \in B$ (resp. $T(t)K \subset B$) (resp. $T(t)U \subset B$) for $t \geq t_0$, $t \in \mathfrak{S}^+$.

As remarked earlier, point dissipativeness was introduced by Levinson (1944). In finite dimensional space, all of the above concepts of dissipativeness are the same.

Definition 4 : Maximal compact invariant set A set $A \subset X$ is said to be the maximal compact invariant set for the dynamical system $T(t)$, $t \in G^+$, if it is compact invariant and maximal with respect to this property.

Definition 5 : Compact global attractor A set $A \subset X$ is said to be the compact global attractor if it is compact invariant and for any bounded set $B \subset X$, we have

$$\lim_{t \in G^+, t \rightarrow \infty} \text{dist}(T(t)B, A) = 0.$$

For ODE in \mathbb{R}^n , Pliss (1966) proved that point dissipativeness implied the existence of a compact global attractor. Using this fact and an asymptotic fixed point theorem of Browder (1959) for completely continuous maps, he was able to prove that a dissipative nonautonomous ODE which is τ -periodic in has a τ -periodic solution; thus, answering in the affirmative the problem of Levinson (1944). For RFDE with

the period τ greater than the delay, Jones (1965) and Yoshizawa (1966) used the same asymptotic fixed point theorem to prove the existence of a τ -periodic solution. Recall that τ greater than the delay makes the Poincaré map completely continuous. In the interval $[0, r]$, it is not completely continuous, but we have seen above that it is the sum of a contraction and a completely continuous operator. We give an abstract fixed point theorem later which will allow us to conclude that the Poincaré map has a fixed point and, therefore, there is a τ -periodic solution, which generalizes the result of Pliss (1966) to RFDE.

In a fundamental paper, Billoti and LaSalle (1971) proved the existence of a compact ²global attractor if $T(t), t \in \mathfrak{S}^+$ is point dissipative and there is a $t_1 \in \mathfrak{S}$ for which $T(t_1)$ is completely continuous. In the discrete case, this implied that there is a periodic point of period t_1 .

Hale, LaSalle and Slemrod (1973) extended these results to the class of asymptotically smooth dynamical systems defined below. This class of dynamical systems includes NFDE with an exponentially stable D_0 operator as well as many other dynamical systems, including those defined by many dissipative partial differential equations.

Definition 6 : *(Asymptotically smooth) A dynamical system $T(t), t \in \mathfrak{S}^+$, on a Banach space X is said to be asymptotically smooth if, for any bounded set B in X for which $T(t)B \subset B$ for $t \in \mathfrak{S}^+$, there is a compact set J in X such that*

$$\lim_{t \in G^+, t \rightarrow \infty} \text{dist}(T(t)B, J) = 0.$$

This definition stated in a different but equivalent way is due to Hale, LaSalle and Slemrod (1973). It is very important to note that a dynamical system can be asymptotically smooth and there can be a bounded set for which the positive orbit is unbounded; for example, the dynamical system defined by the ODE $x' = x$. The definition contains the conditional expression ‘if $T(t)B \subset B, t \in \mathfrak{S}^+$.’

Proposition 2 : *If $T(t), t \in \mathfrak{S}^+$, is asymptotically smooth and B is a bounded set for which there is a $t_1 \in \mathfrak{S}^+$ such that $\gamma^+(T(t_1)B)$ is bounded, then $\omega(B)$ is a compact invariant set. It is connected for continuous dynamical systems if B is connected.*

It is obvious that, if there is a $t_1 \in \mathfrak{S}^+, t_1 > 0$ such that $T(t_1)$ is completely continuous, then $T(t), t \in \mathfrak{S}^+$, is asymptotically smooth. It is also not difficult to prove that, if $T(t) = S(t) + U(t)$ where $U(t)$ is completely continuous for all $t \in \mathfrak{S}^+$, and $S(t)$ is a linear semigroup with spectral radius $\alpha(t) \rightarrow 0$ as $t \rightarrow \infty$, then $T(t), t \in \mathfrak{S}^+$, is asymptotically smooth.

In particular, the semigroup associated with RFDE and NFDE with D_0 exponentially stable are asymptotically smooth. For similar equations with τ -periodicity in time, the Poincaré map is asymptotically smooth.

The following result is essentially due to Hale, LaSalle and Slemrod (1973) with some minor refinements in its statement.

Theorem 8 : *For the dynamical system $T(t), t \in \mathfrak{S}^+$, if there is a nonempty compact set K that attracts compact sets of X and $A = \bigcap_{t \in \mathfrak{S}^+} T(t)K$, then A is independent of K and*

- i) A is the maximal, compact, invariant set,*
- ii) A is connected if X is a Banach space.*
- iii) A is stable and attracts compact sets of X .*
- iv) For any compact set K , there is a neighborhood U_K of K and a $t_0 = t_0(K)$ such that $\gamma^+(T(t_0)U_K)$ is bounded.*

If, in addition, the dynamical system is asymptotically smooth, then

- v) A is also a local attractor.*
- vi) If C is any subset of X for which there is a $t_0 = t_0(C)$ such that $\gamma^+(T(t_0)C)$ is bounded, then A attracts C .*
- vii) In particular, if, for any bounded set B in X , there is a $t_0 = t_0(B)$ such that $\gamma^+(T(t_0)B)$ is bounded, then A is the compact global attractor.*

We also can state the following result.

Theorem 9 : *A dynamical system $T(t), t \in \mathfrak{S}^+$, on X has a compact global attractor if and only if*

- i) $T(t), t \in \mathfrak{S}^+$, is asymptotically smooth.*
- ii) $T(t), t \in \mathfrak{S}^+$, is point dissipative.*
- iii) For any bounded set B in X , there is an $t_0 = t_0(B)$ such that $\gamma^+(T(t_0)B)$ is bounded.*

The sufficiency is proved in the following way. From (i) and (iii), $\omega(B)$ is a compact invariant set which attracts B for any bounded set B . Since (ii) is satisfied, it follows that the compact invariant set which is the ω -limit set of the bounded set in the definition of point dissipative attracts each compact set of X . Theorem 16 implies the existence of the compact global attractor. Conversely, if the compact global attractor exists, then we must have (ii) and (iii) satisfied. Furthermore, if B is a bounded set such that $T(t)B \subset B, t \in G^+$, then $\omega(B)$ must be compact and attract B , which implies that the dynamical system is asymptotically smooth.

Cholewa and Hale (2000) have shown that there is an asymptotically smooth dynamical system and a bounded set B for which $\omega(B)$ is compact and invariant and yet $\gamma^+(B)$ is unbounded.

This shows that (iii) in Theorem 17 cannot be replaced by $\gamma^+(B)$ bounded for each bounded set B .

If the compact global attractor exists, then the most interesting part of the flow defined by the dynamical system occurs on the attractor even though the transient behavior to a neighborhood of the attractor can be very important in a specific application. There are examples of FDE for which the flow on the attractor can be very complicated and the attractor itself is not a manifold. In spite of this, we have the following surprising result of Malné (1981) (for the first part for finite Hausdorff dimension and X a Hilbert space, the result is due to Mallet-Paret (1976)) (for a complete proof, see Hale, Magalhaes and Oliva (2002)).

Theorem 10 : *Suppose that the dynamical system $T(t)$, $t \geq G$, on a Banach space X has a compact invariant set A and has the property that the derivative of $T(t)\varphi$ with respect to φ is the sum of a contraction and a completely continuous operator for each $t > 0$ and $\varphi \in A$. Then*

- (1) *The attractor A has finite capacity $c(A)$.*
- (2) *If S is a linear subspace of X with dimension $\geq 2c(A)+1$, then there is a residual set of the set of all continuous projections on S on which the projection of the flow onto S is one-to-one.*

The first part of the theorem implies that the Hausdorff dimension of A is finite dimension and the second part says that A generically can be embedded into finite dimensional subspaces of X if the dimension is sufficiently large.

We remark that, if the dynamical system has a maximal compact invariant set (in particular, if there is the compact global attractor), then the above properties hold for this set.

8. Stationary points of dissipative flows

As we have remarked earlier, it was of interest to determine the existence of fixed points for the Poincaré map associated with nonautonomous FDE with τ -periodic dependence on t . As a consequence, of some results which will be stated below, we can state the following result (see Hale and Lopes (1973)).

Theorem 11 : 1) *If an autonomous RFDE or NFDE with D_0 exponentially stable is point dissipative, then there is an equilibrium point.*
 2) *If a nonautonomous RFDE or NFDE with periodic coefficients and D_0 exponentially stable is point dissipative, then there is a fixed point of the Poincaré map.*

There is an example of Jones and Yorke (1969) in \mathbb{R}^3 of an ODE for which all solutions are bounded and yet there is no equilibrium point.

This says that some type of dissipation is necessary to obtain the conclusion in (0.1). Notice that part (2) has no restriction on the delay as in the results mentioned previously of Jones (1965) and Yoshizawa (1966).

We now describe the asymptotic fixed point theorem that is used to prove the above result. We remark that the motivation for this fixed point theorem came from the above problem.

Suppose that X is a Banach space. The Kuratowski measure $\alpha(B)$ of noncompactness of a bounded set B in X is defined by

$$\alpha(B) = \inf\{d : B \text{ has a finite cover of diameter } < d\}.$$

A map $T : X \rightarrow X$ is said to be an α -contraction if there is a constant $k \in [0, 1)$ such that, for any bounded set B in X , we have $\alpha(TB) \leq k\alpha(B)$.

The following result was discovered independently and with different proofs by Nussbaum (1972), Hale and Lopes (1973).

Theorem 12 : *If X is a Banach space and $T : X \rightarrow X$ is an α -contraction which is compact dissipative, then there is a fixed point of T .*

We need a few remarks to see why Theorem 19 is a consequence of Theorem 20. In Theorem 19, it is assumed only that the Poincaré is point dissipative and in Theorem 20, compact dissipative is assumed. We have remarked earlier that point dissipative for RFDE implies the existence of the compact global attractor and, therefore, the system must be compact dissipative. For NFDE with an exponentially stable D_0 operator, Massatt (1983) proved that point dissipativeness is equivalent to compact dissipativeness. The proof is nontrivial and uses dissipativeness in two spaces.

It is not known if point dissipative is equivalent to compact dissipative for α -contracting maps.

Final Remarks We have only touched upon a few of the topics in FDE due to limited space. However, the results presented set the stage for much research in the last 35 years - especially, the development of the qualitative theory, stability of the flow on the attractor with respect to the vector field as well as detailed investigation of the flow on the attractor for specific types of equations that occur frequently in the applications.

We can only refer to the reader to the books of Diekmann, van Gils, Lunel and Walther (1991), Hale and Lunel (1993), Kolmanovski and Myshkis (1999), Hale, Magalhaes and Oliva (2002) for FDE on \mathbb{R}^n , Wu (1996) for partial differential equations with delay, Hino, Murakami and Naito (1991), Hino, Naito, Minh and Shin (2002) for RFDE with infinite delay and the lectures on abstract evolutionary functional differential equations at this workshop.

It is clear that the subject is alive and is a good area of research both in theory and applications.

References

- Bellman, R. and J.M. Danskin, Jr. (1954) *A Survey of the Mathematical Theory Time-Lag, Retarded Control and Hereditary Processes*. Report R-256. RAND Corp. Santa Monica CA.
- Bellman, R. and K.L. Cooke (1963) *Differential Difference Equations*. Acad. Press.
- Bellman, R. and K.L. Cooke (1959) Asymptotic behavior of solutions of differential difference equations. *Mem. Am. Math. Soc.* **35**.
- Billotti, J.E. and J.P. LaSalle (1971) Periodic dissipative processes. *Bull. Amer. Math. Soc.* **6**, 1082-1089.
- Browder, F. (1959) On a generalization of the Schauder fixed point theorem. *Duke Math. J.* **26**, 291-303.
- Browder, F. (1965) A further generalization of the Schauder fixed point theorem. *Duke Math. J.* **32**, 575-578.
- Cholewa, J.W. and J.K. Hale (2000) Some counterexamples in dissipative systems. *Dynamics of Continuous, Discrete and Impulsive Systems* **7**, 159-176.
- Cruz, M.A. and J.K. Hale (1971) Exponential estimates and the saddle point property for neutral functional differential equations. *J. Math. Anal. Appl.* **34**, 267-288.
- Diekmann, O., van Gils, S.A., Lunel, S. and H.O. Walther (1991) *Delay Equations, Functional-, Complex-, and Nonlinear Analysis*. Appl. Math. Sci. **110**, Springer.
- Grafton, R. (1969) A periodicity theorem for autonomous functional differential equations. *J. Differential Eqns.* **6**, 87-109.
- Halanay, A. (1966) *Differential Equations, Stability, Oscillations, Time Lags*. Academic Press.
- Hale, J.K. (1963) Linear functional differential equations with constant coefficients. *Contributions to Differential Equations* **2**, 291-319.
- Hale, J.K. (1963) A stability theorem for functional differential equations. *Proc. Nat. Acad. Sci.* **50**, 942-946.
- Hale, J.K. (1965) Sufficient conditions for stability and instability of autonomous functional differential equations. *J. Differential Eqns.* **1**, 452-482.
- Hale, J.K. (1966) Linearly asymptotically autonomous functional differential equations. *Rend. Circ. Palermo* (2) **15**, 331-351.
- Hale, J.K. (1977) *Theory of Functional Differential Equations*. Appl. Math. Sci. **3** (revision and expansion of 1971 Edition), Springer.

- Hale, J.K. (1970) A class of neutral equations with the fixed point property. *Proc. Nat. Acad. Sci.* **67**, 136-137.
- Hale, J.K. and S. Lunel (1993) *Introduction to Functional Differential Equations*. Appl. Math. Sci. **99**, Springer.
- Hale, J.K. and K.R. Meyer (1967) A class of functional differential equations of neutral type. *Mem. Am. Math. Soc.* **76**.
- Hale, J.K., LaSalle, J.P. and M. Slemrod (1973) Theory of a general class of dissipative processes. *J. Math. Anal. Appl.* **39**, 177-191.
- Hale, J.K. and O. Lopes (1973) Fixed point theorems and dissipative processes. *J. Differential Eqns.* **13** 391-402.
- Hale, J.K., Magalhães, L. and W. Oliva (2002) *Dynamics in Infinite Dimensions*. Appl. Math. Sci. **47**, Second Edition, Springer.
- Hale, J.K. and C. Perelló (1964) The neighborhood of a singular point for functional differential equations. *Contributions to Differential Equations* **3**, 351-375.
- Henry, D. (1974) Linear autonomous neutral functional differential equations. *J. Differential Eqns.* **15**, 106-128.
- Henry, D. (1987) Topics in analysis. *Pub. Math. Univ. Aut. Barcelona* **39**, 29-84.
- Hino, Y., Murakami, S. and T. Naito (1991) *Functional Differential Equations with Infinite Delay*. Lect. Notes Math. **1473** Springer-Verlag.
- Hino, Y., Naito, T., Minh, N.V. and J.S. Shin (2002) *Almost Periodic Solutions of Differential Equations in Banach Spaces*. Taylor and Francis, London.
- Jones, G.S. (1962) The existence of periodic solutions of $f'(x) = -\alpha f(x-1)[1 + f(x)]$. *J. Math. Anal. Appl.* **5**, 435-450.
- Kolmanovski, V. and A. Myshkis (1999) *Introduction to the Theory and Applications of Functional Differential Equations*. Kluwer Acad. Publ.
- Krasovskii, N. (1956) Theory of A.M. Lyapunov's second method for investigating stability. *Mat. Sbornik* **40**.
- Krasovskii, N. (1959) *Stability of Motion*. Stanford Univ. Press, 1963). Translation with additions of the 1959 Russian edition.
- Levinson, N. (1944) Transformation theory of nonlinear differential equations of second order. *Annals of Math.* **45**, 724-737.
- Lyapunov, A. M. (1891) *Problème général de la stabilité du mouvement*. Annales Math. Studies **17**(1947). Originally published in 1891.
- Mallet-Paret, J. (1976) Negatively invariant sets of compact maps and an extension of a theorem of Cartwright. *J. Differential Eqns* **22**, 331-348.
- Mané, R. (1981) On the dimension of the compact invariant sets of certain nonlinear maps. In *Lecture Notes in Math.* **898**, 230-242.
- Massatt, P. (1983) Attractivity properties of α -contractions. *J. Differential Eqns* **48**, 326-333.

- Massera, J.L. (1950) The existence of periodic solutions of systems of differential equations. *Duke Math. J.* **17** 457-475.
- Minorsky, N. (1941) Control problems. *J. Franklin Institute* **232**:6, 519-551.
- Minorsky, N. (1962) *Nonlinear Oscillations*. D. Van Nostrand Co., Inc., Princeton.
- Myshkis, A. D. (1951) *Lineare Differentialgleichungen mit nacheilenden Argumentom*. Deutscher Verlag. Wiss. Berlin, 1955. Translation of the 1951 Russian edition.
- Nussbaum, R. (1972) Some asymptotic fixed point theorems. *Trans. Am. Math. Soc.* **171**, 349-375.
- Nussbaum, R. (1974) Periodic solutions of some nonlinear autonomous functional differential equations. *Ann. Math. Pura Appl.* **10**, 263-306.
- Picard, É (1908) La mathématique dans ses rapports avec la physique. *Actes du IV^e congrès international des Mathématiciens, Rome*.
- Pliss, V.A. (1966) *Nonlocal problems in the theory of nonlinear oscillations*. Academic Press. Translation of the 1964 Russian text.
- Razumikhin, B.S. (1956) On the stability of systems with a delay. [Russian] *Prikl. Mat. Meh.* **20**, 500-512.
- Schmitt, E. (1911) Über eine Klasse linearer funktionaler Differentialgleichungen. *Math. Ann.* **70**, 499-524.
- Shimanov, S.N. (1959) On the stability in the critical case of a zero root with time lag. *Prikl. Mat. Meh.* **23**, 836-844.
- Shimanov, S.N. (1965) On the theory of linear differential equations with retardations. [Russian] *Differentialniye Uravneniya* **1**, 102-116.
- Volterra, V. (1909) Sulle equazioni integrodifferenziali della teoria dell'elasticità. *Atti Reale Accad. Lincei* **18**, 295.
- Volterra, V. (1928) Sur la théorie mathématique des phénomènes héréditaires. *J. Math. Pures Appl.* **7**, 249-298.
- Volterra, V. (1931) *Théorie Mathématique de la Lutte pour la Vie*. Gauthier-Villars, Paris.
- Wu, J. *Theory and Application of Partial Functional Differential Equations*. Appl. Math. Sci. **119**, Springer.
- Wright, E.M. (1955) A nonlinear differential-difference equation. *J. Reine Angew. Math.* **194**, 66-87.

I

**GENERAL RESULTS AND LINEAR
THEORY OF DELAY EQUATIONS IN
FINITE DIMENSIONAL SPACES**

Chapter 2

SOME GENERAL RESULTS AND REMARKS ON DELAY DIFFERENTIAL EQUATIONS

E. Ait Dads

Département de Mathématiques, Faculté des Sciences

Université Cadi Ayyad, B.P. 2390 Marrakech, Fax 212 44 43 74 09

Morocco

1. Introduction

In applications, the future behavior of many phenomena are assumed to be described by the solutions of an ordinary differential equation. Implicit in this assumption is that the future behavior is uniquely determined by the present and independent of the past. In differential difference equations, or more generally functional differential equations, the past exerts its influence in a significant manner upon the future. Many models are better represented by functional differential equations, than by ordinary differential equations.

Example 1 *A retarded functional differential equation. Imagine a biological population composed of adult and juvenile individuals. Let $N(t)$ denote the density of adults at time t . Assume that the length of the juvenile period is exactly h units of time for each individual. Assume that adults produce offspring at a per capita rate α and that their probability per unit of time of dying is μ . Assume that a newborn survives the juvenile period with probability ρ and put $t = \alpha\rho$. Then the dynamics of N can be described by the differential equation*

$$\frac{dN}{dt}(t) = -\mu N(t) + rN(t-h) \quad (1.1)$$

which involves a nonlocal term, $rN(t-h)$ meaning that newborns become adults with some delay. So the time variation of the population density N involves the current as well as the past values of N . Such equations

are called *Retarded Functional Differential Equations (RFDE)* or, alternatively, *Delay Equations*.

Equation (1.1) describes the changes in N . To determine a solution past time $t = 0$, we need to prescribe the value of N at time $-h$, and we can see that it is not enough to give the value at the point $-h$, since the following example agree that this condition is not enough to determine completely the solution.

Example 2 The solutions $t \rightarrow \sin \left[\frac{\pi}{2} \left(t + \frac{1}{2} \right) \right]$ and $t \rightarrow \cos \left[\frac{\pi}{2} \left(t + \frac{1}{2} \right) \right]$ of the equation

$$\frac{dx}{dt} = -\frac{\pi}{2}x(t-1) \quad (1.2)$$

coincide at $t = 0$.

In fact, all over the interval $[0, h]$ we have the same problem: in order to integrate the equation past some time $t \in [0, h]$, we need to prescribe the value $N(t-h)$. So we have to prescribe a function on an interval of length h . The most convenient (though not the most natural from a biological point of view) manner to do this is to prescribe N on the interval $[-h, 0]$ and then to use (1.1) for $t \geq 0$. So we supplement (1.1) by

$$N(\theta) = \varphi(\theta) \text{ for } -h \leq \theta \leq 0$$

where φ is a given function. Explicitly, we then have for $t \in [0, h]$

$$N(t) = \varphi(0) \exp(-\mu t) + r \int_0^t \exp(-\mu(t-\tau))\varphi(\tau-h)d\tau.$$

Using this expression we can give an expression for N on the interval $[h, 2h]$, etc.

Thus the method of steps and elementary theory of ordinary differential equations provide us with a very simple existence and uniqueness proof in this example.

Remarks 1) For any continuous function φ defined on $[-h, 0]$, there is a unique solution x of (1.2) on $[-h, \infty]$, denoted $x(\varphi)$.

2) The solution $x(\varphi)$ has a continuous time derivative for $t > 0$, but not at $t = 0$ unless $\varphi(\theta)$ has a left hand derivative at $\theta = 0$ and

$$\frac{d\varphi}{dt}(0) = -\mu\varphi(0) + r\varphi(-h).$$

The solution $x(\varphi)$ is smoother than the initial data.

3) For a given φ on $[-h, 0]$, the solution $x(\varphi)(t)$ of (1.2) need not be defined for $t \leq -h$. In fact, if $x(\varphi)(t)$ is defined for $t \leq -h$, say $x(\varphi)(t)$

is defined for $t \geq -h - \varepsilon$, $\varepsilon > 0$, then $\varphi(\theta)$ must have a continuous first derivative for $\theta \in]-\varepsilon, 0[$.

A more general form of a delay differential equation is as follows:

$$\frac{dx}{dt} = F(t, x(t), x(t - r)).$$

2. A general initial value problem

Given $r > 0$, denote $C([a, b], \mathbb{R}^n)$, the Banach space of continuous functions mapping the interval $[a, b]$ into \mathbb{R}^n with the topology of uniform convergence. If $[a, b] = [-r, 0]$, we let $C = C([-r, 0], \mathbb{R}^n)$ and designate the norm of an element φ in C by $|\varphi| = \sup_{-r \leq \theta \leq 0} |\varphi(\theta)|$. Let $\sigma \in \mathbb{R}$,

$A > 0$ and $x \in C([\sigma - r, \sigma + A], \mathbb{R}^n)$, then for any $t \in [\sigma, \sigma + A]$, we let $x_t \in C$, be defined by

$$x_t(\theta) = x(t + \theta), \text{ for } -r \leq \theta \leq 0.$$

Let $f: \mathbb{R} \times C \rightarrow \mathbb{R}^n$ be a given function. A functional differential equation is given by the following relation

$$\begin{cases} \frac{dx}{dt}(t) = f(t, x_t). \text{ for } t \geq \sigma \\ \text{and } x_\sigma = \varphi. \end{cases} \quad (2.3)$$

Definition 7 x is said to be a solution of (2.3) if there are $\sigma \in \mathbb{R}$, $A > 0$ such that $x \in C([\sigma - r, \sigma + A], \mathbb{R}^n)$ and x satisfies (2.3) for $t \in [\sigma, \sigma + A]$. In such a case we say that x is a solution of (2.3) on $[\sigma - r, \sigma + A]$ for a given $\sigma \in \mathbb{R}$ and a given $\varphi \in C$ we say that $x = x(\sigma, \varphi)$, is a solution of (2.3) with initial value at σ or simply a solution of (2.3) through (σ, φ) if there is an $A > 0$ such that $x(\sigma, \varphi)$ is a solution of (2.3) on $[\sigma - r, \sigma + A]$ and $x_\sigma(\sigma, \varphi) = \varphi$.

Equation (2.3) is a very general type of equation and includes differential-difference equations of the type

$$\frac{dx}{dt}(t) = f(t, x(t), x(t - r(t))) \quad \text{for } 0 \leq r(t) \leq r$$

as well as

$$\frac{dx}{dt}(t) = \int_{-r}^0 g(t, \theta, x(t + \theta)) d\theta.$$

If

$$f(t, \varphi) = L(t, \varphi) + h(t),$$

in which L is linear in φ and $(t, \varphi) \rightarrow L(t, \varphi)$, we say that the equation is a linear delay differential equation, it is called homogeneous if $h \equiv 0$. If $f(t, \varphi) = g(\varphi)$, equation (2.3) is an autonomous one.

Lemma 1 [12] *Let $\sigma \in \mathbb{R}$ and $\varphi \in C$ be given and f be continuous on the product $\mathbb{R} \times C$. Then, finding a solution of equation (2.3) through (σ, φ) is equivalent to solving:*

$$x(t) = \varphi(0) + \int_{\sigma}^t f(s, x_s) ds \quad t \geq \sigma \text{ and } x_{\sigma} = \varphi.$$

2.1 Existence

Lemma 2 [12] *If $x \in C([\sigma - r, \sigma + \alpha], \mathbb{R}^n)$, then, x_t is a continuous function of t for $t \in [\sigma, \sigma + \alpha]$.*

Proof. Since x is continuous on $[\sigma - r, \sigma + \alpha]$, it is uniformly continuous and thus $\forall \varepsilon > 0, \exists \delta > 0$, such that $|x(t) - x(s)| < \varepsilon$ if $|t - s| < \delta$. Consequently for t, s in $[\sigma, \sigma + \alpha]$, $|t - s| < \delta$, we have $|x(t + \theta) - x(s + \theta)| < \varepsilon, \forall \theta \in [-r, 0]$. ■

Theorem 1 [12] *Let D be an open subset of $\mathbb{R} \times C$ and $f: D \rightarrow \mathbb{R}^n$ be continuous. For any $(\sigma, \varphi) \in D$, there exists a solution of equation (2.3) through (σ, φ) .*

Proposition 3 *If f is at most affine i.e. $|f(t, \phi)| \leq a|\phi| + b$ with $a, b > 0$, then there exists a global solution i.e. $\forall \varphi$, the solution $x(\sigma, \varphi)$ is defined on $[\alpha, \infty[$.*

Proof. Let $\varphi \in C$, and assume that the solution is defined only on $[\alpha, \beta[$. By integrating the equation (2.3), one has

$$x(t) = \varphi(0) + \int_0^t f(s, x_s) ds$$

which gives

$$|x(t, \varphi)| = |\varphi| + \int_{\sigma}^t (a|x_s| + b) ds$$

and

$$|x_t(\cdot, \varphi)| = |\varphi| + a \int_{\sigma}^t |x_s| ds + b\beta.$$

By the Gronwall lemma

$$|x_t(\cdot, \varphi)| = (|\varphi| + b\beta) \exp a\beta < \infty..$$

On the other hand

$$\sup_{t \in [0, \beta[} \left| \frac{dx}{dt}(t) \right| < \infty,$$

and gives that the solution is uniformly continuous on $[0, \beta[$ and this implies that $\overline{\lim}_{t \rightarrow \beta} |x_t(\cdot, \varphi)|$ exists and is finite, note it x_β .

Let us consider the following delay differential equation

$$\begin{cases} \frac{dy}{dt} = f(t, y_t) \text{ for } t \geq \beta \\ y_\beta = x_\beta \in C \end{cases}$$

this last equation has at least one solution on $[\beta, \beta + \varepsilon]$ for some $\varepsilon > 0$, and equation (2.3) has at least one solution defined on $[0, \beta + \varepsilon]$, which contradicts the maximality of the solution. ■

Corollary 2 *If f is lipschitzian with respect to the second variable, then it satisfies the property in the proposition below.*

2.2 Uniqueness

Theorem 3 [12] *Let D be an open subset of $\mathbb{R} \times C$ and suppose that $f : D \rightarrow \mathbb{R}^n$ be continuous and $f(t, \varphi)$ be lipschitzian with respect to φ in every compact subset of D . If $(\sigma, \varphi) \in D$, then equation (2.3) has a unique solution passing through (σ, φ) .*

Proof. Consider I_α, B_β as defined in the proof of theorem . and suppose x and y be two solutions of (2.3) on $[\sigma - r, \sigma + \alpha]$ with $x_\sigma = \varphi = y_\sigma$. Then

$$\begin{aligned} x(t) - y(t) &= \int_\sigma^t (f(s, x_s) - f(s, y_s)) ds. & t \geq \sigma \\ x_\sigma - y_\sigma &= 0 \end{aligned}$$

Let k be the Lipschitz constant of $f(t, \varphi)$ in a compact subset containing the trajectories (t, x_t) and (t, y_t) , $t \in I_\alpha$. Choose $\bar{\alpha}$ such that $k\bar{\alpha} < 1$. Then, for $t \in I_{\bar{\alpha}}$ one has:

$$|x(t) - y(t)| \leq \int_\sigma^t k |x_s - y_s| ds \leq k\bar{\alpha} \sup_{\sigma \leq s \leq t} |x_s - y_s|.$$

And this implies that $x(t) = y(t)$ for $t \in I_{\bar{\alpha}}$. ■

The uniqueness may not hold if the function is not locally lipschitzian. For this, let us consider the following counterexamples:

1) There may be two distinct solutions of (2.3) defined on $(-\infty, \infty)$ and they coincide on $(0, \infty)$. The following example was given by A.

Hausrath. Let $r = 1$, $f(s) = 0$, $0 \leq s \leq 1$, $f(s) = -3(\sqrt[3]{s} - 1)^2$, $s > 1$, and consider the equation

$$\frac{dx}{dt}(t) = f(|x_t|).$$

The function $x \equiv 0$ is a solution of this equation on $(-\infty, \infty)$. Also, the function $x(t) = -t^3$, $t < 0$, and $\mathbf{x}(t) \equiv 0$, $t \geq 0$, $\frac{dx}{dt}(t) = -3t^2$. In fact, since $x \leq 1$ for $t \geq -1$, it is clear that x satisfies the equation for $t \geq 0$. Since x is monotone decreasing for $t \leq 0$, $|x_t| = x(t-1) = -(t-1)^3$ and $\frac{dx}{dt}(t) = -3t^2$. It is easy to verify that

$$-3t^2 = f((t-1)^3)$$

for $t < 0$.

2)

$$\frac{d}{dt}x(t) = x(t - \sigma(x(t))) \tag{2.4}$$

where $\sigma : \mathbb{R} \rightarrow [0, 1]$ is smooth, $\sigma'(0) \neq 0$ and $\sigma(0) = 1$.

Note that the right hand side of (2.4) can be written as $G(\varphi) = \varphi(-\sigma(\varphi(0)))$ for $\varphi \in C([-1, 0], \mathbb{R})$ and G is not locally lipschitz in a neighborhood of zero. In fact assume that there exist positive constants k and ρ such that

$$|G(\varphi_1) - G(\varphi_2)| \leq k|\varphi_1 - \varphi_2| \text{ for } |\varphi_1|, |\varphi_2| < \rho$$

Let $\varphi(\theta) = \epsilon(-1 + \sqrt{1 + \theta})$, for $\theta \in [-1, 0]$, where ϵ is a positive constant such that $|\varphi| < \rho$. Let $x \in [-1, 0]$ such that $|\varphi| + |x| < \rho$, then

$$|G(\varphi + x) - G(\varphi)| \leq k|x|$$

which implies

$$\left| \epsilon\sqrt{1 - \sigma(x)} + x \right| \leq k|x| \text{ and } \left| \frac{\epsilon(\sigma(x) - 1)}{x\sqrt{1 - \sigma(x)}} \right| \leq (1 + k).$$

Letting x approaches zero, we obtain a contradiction. Therefore the right hand side of equation (2.4) is not locally lipschitz near zero. The uniqueness has been proved for lipschitzian initial data φ , see [26]. However, the standard argument for uniqueness can not be applied in this example.

The equation

$$\frac{d}{dt}x(t) = x(t - x(t))$$

arises in models of crystal growth, and in fact the related equation

$$\frac{d}{dt}x(t) = -ax(t - \sigma(x(t)))$$

was studied theoretically by Cooke.

$\frac{d}{dt}x(t) = -a(t)x(t) - \lambda b(t)f(x(t - \sigma(x(t))))$ where λ is a positive parameter

has been proposed as models for a variety of physiological processes and conditions including production of blood cells, respiration, and cardiac arrhythmias.

3) The following counter example explains more the situation

$$\begin{cases} \frac{d}{dt}x(t) = x \\ x(\theta) = \sqrt{|\theta|} + 1 \end{cases} \tag{2.5}$$

Then equation (2.5) has two solutions namely

$$x_1(t) = t + \frac{t^2}{4} \text{ and } x_2(t) = t, \text{ for } t \in [0, 1].$$

In fact one has $t - x_1(t) = -\frac{t^2}{4}$. and $t - x_2(t) = 0$, it follows that

$$\begin{aligned} x'_1(t) &= 1 + \frac{t}{2} = \varphi(t - x_1(t)) \text{ and} \\ x'_2(t) &= 1 = \varphi(t - x_2(t)) \text{ for } t \in [0, 1]. \end{aligned}$$

2.3 Continuation of solutions

Definition 8 Suppose f in equation (2.3) is continuous. If x is a solution of equation (2.3) on an interval $[\sigma, a]$, $a > \sigma$, we say \hat{x} is a continuation of x if there is a $b > a$ such that \hat{x} is defined on $[\sigma - r, b]$, coincides with x on $[\sigma - r, a]$, and satisfies Equation (2.3) on $[\sigma, b]$. A solution x is noncontinuable if no such continuation exists; that is the interval $[\sigma, a]$ is the maximal interval of existence of the solution x .

Theorem 4 Furthermore on the hypotheses of the precedent theorem, if f is a bounded function, then equation (2.3) has a maximal solution defined on $[-r, \beta[$ with

$$\text{if } \beta < \infty \implies \overline{\lim}_{t \rightarrow \beta} |x_t(\cdot, \varphi)| = \infty.$$

Proof. By steps, we can integrate the equation (2.3), let $[-r, \beta[$, be the maximal interval on which $x(\cdot, \varphi)$ is defined. Assume that $\overline{\lim}_{t \rightarrow \beta} |x_t(\cdot, \varphi)| < \infty$ then there exists N such that $|x_t(\cdot, \varphi)| \leq N, \forall t \in [0, \beta[$, with $\frac{dx}{dt} = f(t, x_t)$ and from the boundedness of f , we have

$$\sup_{t \in [0, \beta[} \left| \frac{dx}{dt}(t) \right| < \infty,$$

then x is uniformly continuous on $[0, \beta[$. So, $\lim_{t \rightarrow \beta} |x_t(\cdot, \varphi)|$ exists, which we denote by x_β . Let $\psi \in C([-r, \beta[, \mathbb{R}^n)$ defined by $\psi = x_\beta$, under the existence theorem, there exists $\varepsilon > 0$ such that the equation

$$\begin{cases} \frac{dy}{dt} = f(t, y_t) \text{ for } t \geq \beta \\ y_\beta = x_\beta \in C \end{cases}$$

has at least one solution on $[\beta, \beta + \varepsilon]$, the recollement of x and y gives a solution defined on $[\alpha, \beta + \varepsilon]$, which contradicts the maximality of x .

■

Theorem 5 [12] Suppose Ω be an open set in $\mathbb{R} \times \mathbb{C}$, $f : \Omega \rightarrow \mathbb{R}^n$ be globally lipschitz and completely continuous: that is, f is continuous and takes closed bounded sets of Ω into bounded sets of \mathbb{R}^n , and x is a noncontinuable solution of equation (2.3) on $[\sigma - r, b]$. Then, for any closed bounded set U in $\mathbb{R} \times \mathbb{C}$, U in Ω , there is a t_U such that $(t, x_t) \notin U$ for $t_U \leq t < b$.

We now consider the existence of solutions of (2.3) for all $t \geq -r$. The following lemma is needed before we proceed in that direction.

2.4 Dependence on initial values and parameters

Theorem 6 Let D be an open subset of $\mathbb{R} \times \mathbb{C}$ and suppose that $f : D \rightarrow \mathbb{R}^n$ be continuous and $f(t, \varphi)$ be lipschitzian with respect to φ in every compact subset of D . If $(\sigma, \varphi) \in D$, then, the application $\varphi \rightarrow x_t(\cdot, \varphi)$ is continuous lipschitz.

Proof. From the corollary 2 and the fact that f is lipschitzian with respect to the second variable

$$|f(t, \varphi) - f(t, \psi)| \leq k |\varphi - \psi| + |f(t, 0)|.$$

Let $\varphi_1, \varphi_2 \in C$, and $x(\cdot, \varphi_1), x(\cdot, \varphi_2)$ the associated solutions, one has

$$x(t, \varphi_1) - x(t, \varphi_2) = \varphi_1(0) - \varphi_2(0) + \int_0^t (f(s, x(s, \varphi_1)) - f(s, x(s, \varphi_2))) ds.$$

$$|x(t, \varphi_1) - x(t, \varphi_2)| = |\varphi_1 - \varphi_2| + k \int_0^t |x(s, \varphi_1) - x(s, \varphi_2)| ds.$$

By the Gronwall's lemma, one has

$$|x(t, \varphi_1) - x(t, \varphi_2)| \leq |\varphi_1 - \varphi_2| \exp(kt)$$

■

We shall first prove the following lemma, which will be used subsequently.

Lemma 3 [22] *Let $f \in C(J \times C_\rho, \mathbb{R}^n)$. For $t \in J$ and $\phi \in C_\rho$, we put*

$$G(t, r) = \max_{\|\phi\| \leq r} \|f(t, \phi)\|.$$

Suppose that $r^(t, t_0, 0)$ is the maximal solution of*

$$\frac{du}{dt} = G(t, u(t))$$

through $(t_0, 0)$. Then, if $x(t, t_0, \phi_0)$ is any solution of

$$\frac{dx}{dt}(t) = f(t, x_t)$$

with ϕ_0 as an initial value at $t = t_0$. Then, we have :

$$\|x_t(t_0, \phi_0) - \phi_0\| \leq r^*(t, t_0, 0)$$

on the common interval of existence of $x(t, t_0, \phi_0)$ and $r^(t, t_0, 0)$.*

Theorem 7 [22] *Let $f \in C(J \times C_\rho, \mathbb{R}^n)$ and for $t \in J, \varphi, \phi \in C_1$*

$$\|f(t, \varphi) - f(t, \phi)\| \leq g(t, \|\varphi - \phi\|)$$

where $g \in C(J \times [0, 2\rho], \mathbb{R}^+)$. Assume that $u(t) \equiv 0$ is the only solution of the scalar equation

$$\frac{du}{dt} = g(t, u(t))$$

through $(t_0, 0)$. Suppose finally that the solutions $u(t, t_0, u_0)$ through every point (t_0, u_0) exist for $t \geq t_0$ and are continuous with respect to the initial values (t_0, u_0) . Then, the solutions $x(t_0, \phi_0)$ of equation (2.3) are unique and continuous with respect to the initial values (t_0, ϕ_0) .

Using the arguments of the precedent theorems, we can prove the following theorem on dependence on parameters. We merely state.

Theorem 8 [22] Let $f \in C(J \times C_\rho \times \mathbb{R}^m, \mathbb{R}^n)$ and, for $\mu = \mu_0$ let $x_0(t) = x_0(t_0, \phi_0, \mu_0)(t)$ be a solution of

$$\frac{dx}{dt}(t) = f(t, x_t, \mu),$$

with an initial function ϕ_0 at t_0 existing for $t \geq t_0$. Assume that

$$\lim_{\mu \rightarrow \mu_0} f(t, \phi, \mu) = f(t, \phi, \mu_0) \quad \text{uniformly in } (t, \phi),$$

and for $t \in J, \varphi, \phi \in C, \mu \in \mathbb{R}^m$

$$\|f(t, \varphi, \mu) - f(t, \phi, \mu)\| \leq k \|\varphi - \phi\|,$$

Then, $\forall \varepsilon > 0, \exists \delta > 0$ such that for every μ satisfying $|\mu - \mu_0| < \delta(\varepsilon)$, the differential equation

$$\frac{dx}{dt}(t) = f(t, x_t, \mu)$$

admits a unique solution $x(t) = x(t_0, \phi_0, \mu)(t)$ defined on some interval $[t_0, t_0 + a]$ such that $\|x(t) - x_0(t)\| < \varepsilon$ for $t \in [t_0, t_0 + a]$.

2.5 Differentiability of solutions

In precedent section sufficient conditions were given to ensure that the solution $x(\sigma, \varphi, f)$ on a (2.3) depends continuously on (σ, φ, f) . In this section some results are given on the differentiability with respect to (σ, φ, f) .

If Ω is an open set in $\mathbb{R} \times C$, let $C^p(\Omega, \mathbb{R}^n)$, $p \geq 0$ designate the space of functions taking Ω into \mathbb{R}^n that have bounded continuous derivatives up through order p with respect to φ in Ω .

Theorem 9 [12] If $f \in C^p(\Omega, \mathbb{R}^n)$, $p \geq 1$, then the solution $x(\sigma, \varphi, f)$ of the (2.3) through (σ, φ) is unique and continuously differentiable with respect to (φ, f) for t in any compact set in the domain of definition of $x(\sigma, \varphi, f)$. Furthermore, for each $t \geq \sigma$, the derivative of x with respect to φ , $D_\varphi x(\sigma, \varphi, f)(t)$ is a linear operator from C to \mathbb{R}^n , $D_\varphi x(\sigma, \varphi, f)(\sigma) = I$, the identity, and $D_\varphi x(\sigma, \varphi, f)\psi(t)$ for each ψ in C satisfies the linear variational equation

$$y'(t) = D_\varphi f(t, x_t(\sigma, \varphi, f))y_t. \quad (2.6)$$

Also, for each $t \geq \sigma$, $D_f x(\sigma, \varphi, f)(t)$ is a linear operator from $C^p(\Omega, \mathbb{R}^n)$ into \mathbb{R}^n , $D_f x(\sigma, \varphi, f)(\sigma) = 0$, and $D_f x(\sigma, \varphi, f)g(t)$ for each g in $C^p(\Omega, \mathbb{R}^n)$ satisfies the nonhomogeneous variation equation

$$z'(t) = D_\varphi f(t, x_t(\sigma, \varphi, f))z_t + g(t, x_t(\sigma, \varphi, f)). \quad (2.7)$$

Chapter 3

LINEAR AUTONOMOUS FUNCTIONAL DIFFERENTIAL EQUATIONS

Franz Kappel

Institute for Mathematics and Scientific Computing,

University of Graz,

Heinrichstrasse 36,

A 8010 GRAZ (AUSTRIA)

franz.kappel@uni-graz.at

1. Basic Theory

1.1 Preliminaries

Throughout these notes r is a fixed constant, $0 \leq r < \infty$. We denote by \mathcal{C} the Banach space of continuous functions $[-r, 0] \rightarrow \mathbb{C}^n$ with norm $\|\phi\| = \sup_{-r \leq \theta \leq 0} |\phi(\theta)|$, where $|\cdot|$ is any vector norm in \mathbb{C}^n . If $x : [-r, \alpha) \rightarrow \mathbb{C}^n$, $\alpha > 0$, is a continuous function, then $x_t \in \mathcal{C}$, $0 \leq t < \alpha$, is defined by

$$x_t(\theta) = x(t + \theta), \quad -r \leq \theta \leq 0.$$

Let L be a bounded linear functional $\mathcal{C} \rightarrow \mathbb{C}^n$ and choose $\phi \in \mathcal{C}$. Then we shall consider the following Cauchy problem:

$$\dot{x}(t) = L(x_t), \quad t \geq 0, \tag{1.1}$$

$$x_0 = \phi. \tag{1.2}$$

A solution of problem (1.1), (1.2) on $[0, \infty)$ will be denoted by $x(t) = x(t; \phi)$ and is a continuous function $[-r, \infty) \rightarrow \mathbb{C}^n$ such that

$$x(t) = \phi(0) + \int_0^t L(x_\tau) d\tau, \quad t \geq 0,$$

$$x(t) = \phi(t), \quad -r \leq t \leq 0.$$

Since $t \rightarrow x_t$ is a continuous mapping $[0, \infty) \rightarrow \mathcal{C}$, the function $t \rightarrow L(x_t)$ is continuous for $t \geq 0$, which implies that $x(t)$ is continuously

differentiable for $t \geq 0$ and equation (1.1) is satisfied on $[0, \infty)$ (at $t = 0$ the derivative is understood to be the right-hand derivative, of course). Since equation (1.1) is autonomous, it is clear that taking $t = 0$ as initial time is no restriction of generality.

In addition to problem (1.1), (1.2) we also shall consider the nonhomogeneous problem

$$\dot{x}(t) = L(x_t) + f(t), \quad t \geq 0, \quad (1.3)$$

$$x_0 = \phi \in \mathcal{C}, \quad (1.4)$$

where f is a locally integrable function $[0, \infty) \rightarrow \mathbb{C}^n$. A solution $x(t) = x(t; \phi, f)$ of (1.3), (1.4) on $[0, \infty)$ is a continuous function $[-r, \infty) \rightarrow \mathbb{C}^n$ such that

$$\begin{aligned} x(t) &= \phi(0) + \int_0^t L(x_\tau) d\tau + \int_0^t f(\tau) d\tau, \quad t \geq 0, \\ x(t) &= \phi(t), \quad -r \leq t \leq 0. \end{aligned} \quad (1.5)$$

It is clear that $x(t; \phi, f)$ is absolutely continuous on bounded subintervals of $[0, \infty)$ and that (1.3) is satisfied almost everywhere on $[0, \infty)$.

By the Riesz representation theorem (cf. [31], for instance) there exists a matrix $\eta = (\eta_{ij})_{i,j=1,\dots,n}$ of bounded variation on $[-r, 0]$ such that

$$\begin{aligned} L(\phi) &= \text{col} \left(\sum_{j=1}^n \int_{-r}^0 \phi_j(\theta) d\eta_{1j}(\theta), \dots, \sum_{j=1}^n \int_{-r}^0 \phi_j(\theta) d\eta_{nj}(\theta) \right) \\ &=: \int_{-r}^0 [d\eta(\theta)] \phi(\theta), \quad \phi \in \mathcal{C}. \end{aligned} \quad (1.6)$$

The norm of L will be denoted by ℓ , i.e.,

$$\ell = \sup\{|L(\phi)| \mid \|\phi\| = 1\}.$$

Moreover, if $\Phi = (\phi_1, \dots, \phi_n)$ is an $n \times n$ -matrix with columns $\phi_j \in \mathcal{C}$, then $L(\Phi) := (L(\phi_1), \dots, L(\phi_n))$. It will be useful to extend the definition of η to all of \mathbb{R} and, in addition, to assume that the extension is normalized in the following sense:

$$\begin{aligned} \eta(\theta) &= 0 \quad \text{for } \theta \geq 0, \\ \eta(\theta) &= \eta(-r) \quad \text{for } \theta \leq -r, \\ \eta &\text{ is left-hand continuous on } (-r, 0). \end{aligned} \quad (1.7)$$

From the theory of functions of bounded variation it is well known (cf. for instance [15]) that η can be represented as

$$\eta = \eta^1 + \eta^2 + \eta^3,$$

where η^1 is a saltus function of bounded variation with at most countably many jumps on $[-r, 0]$, η^2 is an absolutely continuous function on $[-r, 0]$ and η^3 is either zero or a singular function of bounded variation on $[-r, 0]$, i.e., η^3 is non constant, continuous and has derivative $\dot{\eta}^3 = 0$ almost everywhere on $[-r, 0]$. In view of (1.7) we can assume $\eta^1(0) = \eta^2(0) = \eta^3(0) = 0$.

Consider $\eta^1 = (\eta_{ij}^1) \not\equiv 0$ and let $-r_1, -r_2, \dots$ be an enumeration of those points in $[-r, 0]$ where at least one η_{ij}^1 has a jump. Define $A_k = (a_{ij}^k)_{i,j=1,\dots,n}$, where $a_{ij}^k = \eta_{ij}^1(-r_k + 0) - \eta_{ij}^1(-r_k - 0)$. Then

$$\int_{-r}^0 [d\eta^1(\theta)] \phi(\theta) = \sum_{k=1}^{\infty} A_k \phi(-r_k), \quad \phi \in \mathcal{C}.$$

η^1 being a function of bounded variation is equivalent to

$$\sum_{k=1}^{\infty} |A_k| < \infty,$$

where $|\cdot|$ can be any matrix norm.

For η^2 we define $A(\theta)$ by

$$\eta^2(\theta) = \int_0^{\theta} A(\theta) d\theta, \quad -r \leq \theta \leq 0.$$

Then

$$\int_{-r}^0 [d\eta^2(\theta)] \phi(\theta) = \int_{-r}^0 A(\theta) \phi(\theta) d\theta, \quad \phi \in \mathcal{C}.$$

Since the functions η_{ij}^2 are of bounded variation, we have $\int_{-r}^0 |A(\theta)| d\theta < \infty$.

If $\eta^3 \not\equiv 0$, then $\int_{-r}^0 [d\eta^3(\theta)] \phi(\theta)$ cannot be transformed to a Lebesgue integral or to a series. For a concrete example see [15, p. 457]. For most situations it is sufficient to consider the special case where $\eta^3 \equiv 0$ and η^1 has only a finite number of jumps,

$$L(\phi) = \sum_{k=0}^m A_k \phi(-r_k) + \int_{-r}^0 A(\theta) \phi(\theta) d\theta, \quad \phi \in \mathcal{C},$$

where $0 = r_0 < r_1 < \dots < r_m = r$, the A_k 's are constant $n \times n$ -matrices and $\theta \rightarrow A(\theta)$ is integrable in $[-r, 0]$. The corresponding matrix valued

function η^1 is given by

$$\eta^1(\theta) = \begin{cases} 0 & \text{for } \theta \geq 0, \\ -A_0 & \text{for } -r_1 < \theta < 0, \\ -(A_0 + A_1) & \text{for } -r_2 < \theta \leq -r_1, \\ \vdots & \\ -\sum_{k=0}^{m-1} A_k & \text{for } -r_m < \theta \leq -r_{m-1}, \\ -\sum_{k=0}^m A_k & \text{for } \theta \leq -r_m. \end{cases}$$

1.2 Existence and uniqueness of solutions

In this section we consider existence and uniqueness of solutions for the problems (1.1), (1.2) and (1.3), (1.4). We first prove some estimates which will be useful later.

Lemma 1.1 *Let $x(t) = x(t; \phi, f)$ be a solution of (1.3), (1.4) on $[0, \infty)$. Then we have the estimate*

$$\|x_t(\phi, f)\| \leq (\|\phi\| + \int_0^t |f(\tau)| d\tau) e^{\ell t}, \quad t \geq 0, \quad (1.8)$$

and consequently

$$|L(x_t(\phi, f))| \leq \ell(\|\phi\| + \int_0^t |f(\tau)| d\tau) e^{\ell t}, \quad t \geq 0. \quad (1.9)$$

Proof. For $t \geq 0$ and $-r \leq \theta \leq 0$ we immediately get from (1.5) the estimates

$$\begin{aligned} |x(t + \theta)| &\leq |\phi(0)| + \ell \int_0^{t+\theta} \|x_\tau\| d\tau + \int_0^{t+\theta} |f(\tau)| d\tau \\ &\leq \|\phi\| + \ell \int_0^t \|x_\tau\| d\tau + \int_0^t |f(\tau)| d\tau, \quad t + \theta \geq 0, \end{aligned}$$

and

$$|x(t + \theta)| = |\phi(t + \theta)| \leq \|\phi\|, \quad t + \theta \leq 0.$$

Therefore we have

$$\|x_t\| \leq \|\phi\| + \int_0^t |f(\tau)| d\tau + \ell \int_0^t \|x_\tau\| d\tau, \quad t \geq 0.$$

The estimate (1.8) now follows from Gronwall's inequality. ■

Uniqueness of solutions is an immediate consequence of Lemma 1.1.

Proposition 1.2 For any $\phi \in \mathcal{C}$ and any $f \in L^1_{\text{loc}}(0, \infty; \mathbb{C}^n)$ there exists exactly one solution of problem (1.3), (1.4) on $[0, \infty)$.

Proof. A continuous function $[-r, \infty) \rightarrow \mathbb{C}^n$ is a solution of (1.3), (1.4) if and only if the restriction of x to any interval $[0, T]$, $T > 0$, is a fixed point of the operator \mathcal{T}_T defined by

$$(\mathcal{T}_T y)(t) = \phi(0) + \int_0^t L(\tilde{y}_\tau) d\tau + \int_0^t f(\tau) d\tau, \quad 0 \leq t \leq T,$$

in the Banach space $C_0(0, T; \mathbb{C}^n)$ of all continuous functions $y : [0, T] \rightarrow \mathbb{C}^n$ with $y(0) = \phi(0)$ supplied with the sup-norm. For $y \in C_0(0, T; \mathbb{C}^n)$, the function \tilde{y} is defined by $\tilde{y}(t) = \phi(t)$ for $-r \leq t \leq 0$ and $\tilde{y}(t) = y(t)$ for $0 < t \leq T$. We choose a negative constant $\gamma < -\ell$ and supply $C_0(0, T; \mathbb{C}^n)$ with the equivalent norm

$$\|y\|_\gamma = \sup_{0 \leq t \leq T} |y(t)|e^{\gamma t}, \quad y \in C_0(0, T; \mathbb{C}^n).$$

It is clear that $\mathcal{T}_T C_0(0, T; \mathbb{C}^n) \subset C_0(0, T; \mathbb{C}^n)$. For $y, z \in C_0(0, T; \mathbb{C}^n)$ we get

$$|(\mathcal{T}_T y)(t) - (\mathcal{T}_T z)(t)| \leq \ell \int_0^t \|\tilde{y}_\tau - \tilde{z}_\tau\| d\tau.$$

Since $\tilde{y}(t) - \tilde{z}(t) = 0$ for $-r \leq t \leq 0$ and $\gamma < 0$, we have

$$\begin{aligned} \|\tilde{y}_\tau - \tilde{z}_\tau\| &= \sup_{-r \leq \theta \leq 0} |\tilde{y}(\tau + \theta) - \tilde{z}(\tau + \theta)|e^{\gamma(\tau + \theta)}e^{-\gamma(\tau + \theta)} \\ &\leq e^{-\gamma\tau} \sup_{0 \leq t \leq T} |y(t) - z(t)|e^{\gamma t} = e^{-\gamma\tau} \|y - z\|_\gamma. \end{aligned}$$

This implies

$$|(\mathcal{T}_T y)(t) - (\mathcal{T}_T z)(t)| \leq \ell \|y - z\|_\gamma \int_0^t e^{-\gamma\tau} d\tau < -\frac{\ell}{\gamma} \|y - z\|_\gamma e^{-\gamma t}$$

for $0 \leq t \leq T$, which proves

$$\|\mathcal{T}_T y - \mathcal{T}_T z\|_\gamma < -\frac{\ell}{\gamma} \|y - z\|_\gamma.$$

By choice of γ we have $0 < -\ell/\gamma < 1$, i.e., \mathcal{T}_T is a contraction on $C_0(0, T; \mathbb{C}^n)$. Let $y(\cdot, T)$ be the unique fixed point of \mathcal{T}_T on $C_0(0, T; \mathbb{C}^n)$. It is clear that there exists exactly one function $x : [-r, \infty) \rightarrow \mathbb{C}^n$ such that $x(t) = \phi(t)$ for $-r \leq t \leq 0$ and $x(t) = y(t, T)$ for $0 \leq t \leq T$ and any $T > 0$. ■

Proposition 1.3 For any $T > 0$ the mapping $\sigma : \mathcal{C} \times L^1(0, T; \mathbb{C}^n) \rightarrow C(0, T; \mathbb{C}^n)$ defined by $\sigma(\phi, f)(t) = x_t(\phi, f)$, $0 \leq t \leq T$, is bounded and linear.

Proof. Boundedness of σ is an obvious consequence of (1.8). ■

1.3 The Laplace-transform of solutions. The fundamental matrix

Throughout this section we consider the homogenous problem (1.1), (1.2). In this case inequality (1.8) implies

$$|x(t; \phi)| \leq \|\phi\| e^{\ell t}, \quad t \geq 0,$$

for any solution of (1.1), (1.2). Therefore the Laplace-transform

$$\hat{x}(\lambda) = \hat{x}(\lambda; \phi) = \int_0^{\infty} e^{-\lambda t} x(t; \phi) dt$$

exists at least for $\operatorname{Re} \lambda > \ell$, the integral converging absolutely in this half plane. Similarly inequality (1.9) together with equation (1.1) shows that also $\dot{x}(t)$ has a Laplace-transform at least in $\operatorname{Re} \lambda > \ell$ given by $\lambda \hat{x}(\lambda) - \phi(0)$ ¹. Taking Laplace-transforms on both sides of equation (1.1) we get for $\operatorname{Re} \lambda > \ell$

$$\begin{aligned} \lambda \hat{x}(\lambda) - \phi(0) &= \int_0^{\infty} e^{-\lambda t} \int_{-r}^0 [d\eta(\theta)] x(t + \theta) dt \\ &= \int_{-r}^0 [d\eta(\theta)] \int_0^{\infty} e^{-\lambda t} x(t + \theta) dt \\ &= \int_{-r}^0 [d\eta(\theta)] \int_{\theta}^0 e^{\lambda(\theta - \tau)} \phi(\tau) d\tau + \int_{-r}^0 e^{\lambda\theta} d\eta(\theta) \cdot \hat{x}(\lambda). \end{aligned}$$

Interchanging Stieltjes integration with improper Riemann integration is justified by Fubini's theorem. Thus we have

$$\Delta(\lambda) \hat{x}(\lambda) = p(\lambda; \phi), \quad \operatorname{Re} \lambda > \ell,$$

where, for $\lambda \in \mathbb{C}$, we define

$$\Delta(\lambda) = \lambda I - \int_{-r}^0 e^{\lambda\theta} d\eta(\theta)$$

and

$$p(\lambda; \phi) = \phi(0) + \int_{-r}^0 [d\eta(\theta)] \int_{\theta}^0 e^{\lambda(\theta - \tau)} \phi(\tau) d\tau, \quad \phi \in \mathcal{C}.$$

In order to save space we introduce the following notation. For $j = 0, 1, \dots$ and $\lambda \in \mathbb{C}$ the function $e_j(\lambda) \in \mathcal{C}$ is defined by

$$e_j(\lambda)(\theta) = \frac{\theta^j}{j!} e^{\lambda\theta}, \quad -r \leq \theta \leq 0. \quad (1.10)$$

¹In fact, the existence of a Laplace-transform for $\dot{x}(t)$ implies the same for $x(t)$ (see Theorem A.3)

Furthermore, for functions $f, g \in L^1(-r, 0; \mathbb{C})$ the convolution $h = f * g$ on $[-r, 0]$ is defined by

$$h(\theta) = \int_0^\theta f(\theta - \tau)g(\tau) d\tau, \quad -r \leq \theta \leq 0.$$

With these notations $p(\lambda; \phi)$ can be written as

$$\begin{aligned} p(\lambda; \phi) &= \phi(0) - \int_{-r}^0 [d\eta(\theta)](e_0(\lambda) * \phi)(\theta) \\ &= \phi(0) - L(e_0(\lambda) * \phi), \quad \phi \in \mathcal{C}, \lambda \in \mathbb{C}. \end{aligned}$$

For $\lambda \neq 0$ we may write

$$\Delta(\lambda) = \lambda \left(I - \frac{1}{\lambda} \int_{-r}^0 e^{\lambda\theta} d\eta(\theta) \right).$$

Since

$$\left| \int_{-r}^0 e^{\lambda\theta} d\eta_{ij}(\theta) \right| \leq \begin{cases} \text{var}_{[-r,0]} \eta_{ij} & \text{for } \text{Re } \lambda \geq 0, \\ e^{-r \text{Re } \lambda} \text{var}_{[-r,0]} \eta_{ij} & \text{for } \text{Re } \lambda < 0, \end{cases} \quad (1.11)$$

there exists a constant $K > 0$ such that for any $\alpha > 0$

$$\left| \frac{1}{\lambda} \int_{-r}^0 e^{\lambda\theta} d\eta(\theta) \right| \leq \frac{K}{|\lambda|} \leq \frac{K}{\alpha} \quad \text{for } \text{Re } \lambda \geq \alpha. \quad (1.12)$$

This means that, for $\text{Re } \lambda > K$, the matrix $\Delta^{-1}(\lambda)$ is given by

$$\Delta^{-1}(\lambda) = \frac{1}{\lambda} \sum_{j=0}^{\infty} \left(\frac{1}{\lambda} \int_{-r}^0 e^{\lambda\theta} d\eta(\theta) \right)^j, \quad (1.13)$$

the series converging absolutely. Moreover, for any $\varepsilon > 0$ the series is uniformly convergent for $\text{Re } \lambda \geq K + \varepsilon$. We summarize our results in

Theorem 1.4 a) *The Laplace-integral for $x(t) = x(t; \phi)$, $\phi \in \mathcal{C}$, is absolutely convergent at least for $\text{Re } \lambda > \ell$.*

b) *The Laplace-transform $\hat{x}(\lambda) = \hat{x}(\lambda; \phi)$ of $x(t; \phi)$ exists at least in the set $\{\lambda \in \mathbb{C} \mid \det \Delta(\lambda) \neq 0\}$ and, on this set, is given by*

$$\hat{x}(\lambda) = \Delta^{-1}(\lambda)p(\lambda; \phi),$$

where, for $\lambda \in \mathbb{C}$,

$$\begin{aligned} \Delta(\lambda) &= \lambda I - L(e^{\lambda \cdot} I) = \lambda I - \int_{-r}^0 e^{\lambda\theta} d\eta(\theta), \\ p(\lambda; \phi) &= \phi(0) - L(e_0(\lambda) * \phi) = \phi(0) + \int_{-r}^0 [d\eta(\theta)] \int_{\theta}^0 e^{\lambda(\theta-\tau)} \phi(\tau) d\tau. \end{aligned}$$

Moreover, there exists a constant $K > 0$ such that

$$\Delta^{-1}(\lambda) = \frac{1}{\lambda} \sum_{j=0}^{\infty} \left(\frac{1}{\lambda} \int_{-r}^0 e^{\lambda\theta} d\eta(\theta) \right)^j \quad \text{for } \operatorname{Re} \lambda > K,$$

the series being uniformly and absolutely convergent in each half plane $\operatorname{Re} \lambda \geq K + \varepsilon$, $\varepsilon > 0$.

Note that the elements of $\Delta(\lambda)$ and therefore also $\det \Delta(\lambda)$ are entire functions. The same is true for $p(\lambda; \phi)$. Therefore the zeros of $\det \Delta(\lambda)$ are isolated on \mathbb{C} and consequently the elements of $\Delta^{-1}(\lambda)$ only can have poles in \mathbb{C} . The Laplace-transform $\hat{x}(\lambda)$ therefore is a meromorphic function in \mathbb{C} .

Theorem 1.5 $\Delta^{-1}(\lambda)$ is the Laplace-transform for a function $Y(t)$, which is locally absolutely continuous on $[0, \infty)$. The Laplace-integral for $Y(t)$ is absolutely convergent in some half plane $\operatorname{Re} \lambda > \beta$. Moreover, $Y(t)$ can be represented as

$$Y(t) = I + \int_0^t H(\tau) d\tau, \quad t \geq 0,$$

where $H(t) = \sum_{j=1}^{\infty} h_j(t)$ and²

$$h_j(t) = (-1)^j \eta(-t) \underbrace{* \cdots *}_{j\text{-times}} \eta(-t), \quad j = 1, 2, \dots$$

The series for $H(t)$ is uniformly and absolutely convergent on bounded t -intervals, so that

$$\int_0^t H(\tau) d\tau = \sum_{j=1}^{\infty} \int_0^t h_j(\tau) d\tau, \quad t \geq 0.$$

The proof of this theorem is based on the following lemma:

Lemma 1.6 The function

$$\hat{h}(\lambda) = \frac{1}{\lambda} \int_{-r}^0 e^{\lambda\theta} d\eta(\theta), \quad \lambda \neq 0,$$

is the Laplace-transform of $h_1(t) = -\eta(-t)$, $t \geq 0$, the Laplace-integral converging absolutely for $\operatorname{Re} \lambda > 0$. Consequently, $(\hat{h}(\lambda))^j$, $j = 1, 2, \dots$,

²“*” here denotes the convolution of functions defined on $[0, \infty)$

is the Laplace-transform of the j -times iterated convolution $h_j(t)$ of $h_1(t)$. Also the Laplace-integrals for $h_j(t)$, $j = 1, 2, \dots$, are absolutely convergent for $\operatorname{Re} \lambda > 0$.

Proof. Integration by parts together with $\eta(0) = 0$ gives

$$\begin{aligned} \frac{1}{\lambda} \int_{-r}^0 e^{\lambda\theta} d\eta(\theta) &= -\frac{1}{\lambda} e^{-\lambda r} \eta(-r) - \int_{-r}^0 \eta(\theta) e^{\lambda\theta} d\theta \\ &= -\frac{1}{\lambda} e^{-\lambda r} \eta(-r) - \int_0^r \eta(-\theta) e^{-\lambda\theta} d\theta = -\int_0^\infty \eta(-\theta) e^{-\lambda\theta} d\theta, \end{aligned}$$

which proves the result for \hat{h} . Absolute convergence of the Laplace-integral for $\operatorname{Re} \lambda > 0$ is clear because $\eta(-\theta) = \eta(-r)$ for $\theta \geq r$. The rest of the proof follows from standard results on Laplace-transforms of convolutions (cf. Theorem A.7). ■

Proof of Theorem 1.5. In order to show that $\Delta^{-1}(\lambda)$ is a Laplace-transform we apply Theorem A.9 to

$$\hat{H}(\lambda) = \sum_{j=1}^{\infty} \hat{h}(\lambda)^j.$$

By Lemma 1.6 each of the functions $\hat{h}(\lambda)^j$ is a Laplace-transform with the Laplace-integral converging absolutely in $\operatorname{Re} \lambda > 0$. Thus condition (i) of Theorem A.9 is satisfied for any $\alpha_0 > 0$. It remains to prove that

$$\sum_{j=1}^{\infty} \int_0^\infty e^{-\alpha_0 t} |h_j(t)| dt \tag{1.14}$$

is convergent for an $\alpha_0 > 0$. We claim that for any $\alpha > 0$

$$\int_0^\infty e^{-\alpha t} |h_j(t)| dt \leq \left(\int_0^\infty e^{-\alpha t} |h_1(t)| dt \right)^j. \tag{1.15}$$

This is proved by induction. Assume that (1.15) is true for $j - 1$. Then we get

$$\begin{aligned}
 \int_0^\infty e^{-\alpha t} |h_j(t)| dt &= \int_0^\infty e^{-\alpha t} \left| \int_0^t h_1(t-\tau) h_{j-1}(\tau) d\tau \right| dt \\
 &\leq \int_0^\infty e^{-\alpha t} \int_0^t |h_1(t-\tau)| |h_{j-1}(\tau)| d\tau dt \\
 &= \int_0^\infty \int_\tau^\infty e^{-\alpha(t-\tau)} |h_1(t-\tau)| e^{-\alpha\tau} |h_{j-1}(\tau)| dt d\tau \\
 &= \int_0^\infty e^{-\alpha\tau} |h_{j-1}(\tau)| d\tau \int_0^\infty e^{-\alpha\tau} |h_1(\tau)| d\tau \\
 &\leq \left(\int_0^\infty e^{-\alpha\tau} |h_1(\tau)| d\tau \right)^j.
 \end{aligned}$$

Interchanging the order of integration is justified by Fubini's theorem, because $|h_1| * |h_{j-1}| = O(t^{j-1})$ as $t \rightarrow \infty$, which in turn is a consequence from the fact that $|h_1(\tau)|$ is constant for $\tau \geq r$. Setting $\beta = \sup_{0 \leq t < \infty} |h_1(t)|$ we get

$$\int_0^\infty e^{-\alpha t} |h_1(t)| dt \leq \frac{\beta}{\alpha}.$$

Therefore, we have convergence of the series (1.14) if we choose $\alpha_0 > \beta$. Theorem A.9 implies that $\hat{H}(\lambda)$ is the Laplace-transform of

$$H(t) = \sum_{j=1}^{\infty} h_j(t), \quad t \geq 0,$$

the series being absolutely convergent. Moreover, the Laplace-integral for $H(t)$ is absolutely convergent for $\operatorname{Re} \lambda > \beta$ (note that α_0 could be arbitrarily $> \beta$). Since $\eta(-t)$ is bounded on $t \geq 0$, say $|\eta(-t)| \leq a$, we get $|h_{j+1}(t)| \leq a(at)^j/j!$, $j = 0, 1, \dots$. This proves uniform convergence of $\sum_{j=1}^{\infty} h_j(t)$ on bounded intervals. To finish the proof we have to observe that

$$\Delta^{-1}(\lambda) = \frac{1}{\lambda} I + \frac{1}{\lambda} \hat{H}(\lambda),$$

which implies that $\Delta^{-1}(\lambda)$ is the Laplace-transform of

$$Y(t) = I + \int_0^t H(\tau) d\tau, \quad t \geq 0. \quad (1.16)$$

This also shows that $Y(t)$ is locally absolutely continuous on $[0, \infty)$. Convergence of the Laplace-integral for $H(t)$ in $\operatorname{Re} \lambda > \beta$ implies that

$\int_0^t H(\tau) d\tau = o(e^{\alpha t})$ as $t \rightarrow \infty$ for any $\alpha > \beta$ (Theorem A.2) and therefore we have absolute convergence of the Laplace-integral of $Y(t)$ in $\text{Re } \lambda > \beta$. ■

The precise abscissa of absolute convergence for the Laplace-integral of $Y(t)$ will be determined later (see Theorem 1.21 and Definition 1.19). We next relate $Y(t)$ to equation (1.1).

Theorem 1.7 a) $Y(t)$ is the unique solution of

$$\begin{aligned} Y(t) &= I - \int_0^t Y(t-\tau)\eta(-\tau) d\tau, \quad t \geq 0, \\ Y(t) &= 0 \quad \text{for } t < 0. \end{aligned} \quad (1.17)$$

b) $L(Y_t) = \int_{-r}^0 [d\eta(\theta)]Y(t+\theta)$ is defined on $[0, \infty)$ with the exception of a countable subset of $[0, r]$ and $Y(t)$ is the unique solution of

$$\begin{aligned} \dot{Y}(t) &= L(Y_t) \quad \text{a.e. for } t \geq 0, \\ Y(0) &= I \quad \text{and } Y(t) = 0 \quad \text{for } -r \leq t < 0. \end{aligned} \quad (1.18)$$

Since the columns of Y_t are in \mathcal{C} for $t \geq r$, the function $Y(t)$ is continuously differentiable for $t \geq r$ and equation (1.18) holds everywhere on $[r, \infty)$.

Proof of Theorem 1.7. a) From the identity

$$I = \Delta^{-1}(\lambda)\Delta(\lambda) = \Delta^{-1}(\lambda) - \Delta^{-1}(\lambda)\hat{h}(\lambda) \quad (1.19)$$

we get using Lemma 1.6 and Theorem 1.5

$$I = Y(t) + \int_0^t Y(t-\tau)\eta(-\tau) d\tau, \quad t \geq 0,$$

which is (1.17). If $Y_i(t)$, $i = 1, 2$, are two solutions of (1.17), then

$$|Y_1(t) - Y_2(t)| \leq \sup_{-r \leq \theta \leq 0} |\eta(\theta)| \int_0^t |Y_1(\tau) - Y_2(\tau)| d\tau, \quad t \geq 0,$$

which by Gronwall's inequality implies $Y_1(t) \equiv Y_2(t)$.

Since $\dot{Y}(t) = H(t)$ a.e. on $t \geq 0$, the Laplace-transform of $\dot{Y}(t)$ exists and is given by $\lambda\Delta^{-1}(\lambda) - I$. From the identity

$$\lambda\Delta^{-1}(\lambda) - I = \sum_{j=1}^{\infty} \hat{h}(\lambda)^j = \hat{h}(\lambda)(\lambda\Delta^{-1}(\lambda) - I) + \hat{h}(\lambda) \quad (1.20)$$

we get

$$\dot{Y}(t) = - \int_0^t \eta(\tau - t) \dot{Y}(\tau) d\tau - \eta(-t) \quad \text{a.e. on } t \geq 0.$$

Integration by parts gives

$$\begin{aligned} \int_0^t \eta(\tau - t) \dot{Y}(\tau) d\tau &= \int_0^t \eta(\tau - t) dY(\tau) \\ &= \eta(0)Y(t) - \eta(-t)Y(0) - \int_0^t [d\eta_\tau(\tau - t)]Y(\tau) \\ &= -\eta(-t) - \int_{-t}^0 [d\eta(\theta)]Y(t + \theta). \end{aligned}$$

Therefore

$$\dot{Y}(t) = \int_{-t}^0 [d\eta(\theta)]Y(t + \theta) = \int_{\max(-t, -r)}^0 [d\eta(\theta)]Y(t + \theta) \quad \text{a.e. on } t \geq 0. \quad (1.21)$$

If $-t$ is in $[-r, 0]$ and η is continuous at $-t$, then

$$\int_{-t}^0 [d\eta(\theta)]Y(t + \theta) = \int_{-r}^0 [d\eta(\theta)]Y(t + \theta).$$

Since η is discontinuous on an at most countable set, we get the assertion concerning $L(Y_t)$ and equation (1.21) implies (1.18).

If $Y_i(t)$, $i = 1, 2$, are two solutions of (1.18), then the columns of $Y_1(t) - Y_2(t)$ are solutions of the homogeneous equation (1.1) with $\phi = 0$. Consequently we have $Y_1(t) \equiv Y_2(t)$. ■

Remarks. 1. Since instead of (1.19) and (1.20) we can also use the identities

$$\frac{1}{\lambda} I = \Delta^{-1}(\lambda) - \hat{h}(\lambda)\Delta^{-1}(\lambda)$$

and

$$\lambda\Delta^{-1}(\lambda) - I = (\lambda\Delta^{-1}(\lambda) - I)\hat{h}(\lambda) + \hat{h}(\lambda),$$

we see that $Y(t)$ is also the unique solution of

$$\begin{aligned} Y(t) &= I - \int_0^t \eta(-\tau)Y(t - \tau) d\tau, \quad t \geq 0, \\ Y(t) &= 0, \quad t < 0, \end{aligned} \quad (1.22)$$

and

$$\begin{aligned} \dot{Y}(t) &= \int_{-r}^0 Y(t+\theta) d\eta(\theta) \quad \text{a.e. on } t \geq 0, \\ Y(0) &= I \quad \text{and} \quad Y(t) = 0 \quad \text{on } t < 0. \end{aligned} \quad (1.23)$$

2. Instead of applying Theorem A.9 to $\hat{H}(\lambda)$ we could also proceed as follows. We write

$$\hat{H}(\lambda) = \frac{1}{\lambda} \int_{-r}^0 e^{\lambda\theta} d\eta(\theta) + \sum_{j=2}^{\infty} \hat{h}(\lambda)^j.$$

The first term is a Laplace-transform by Lemma 1.6, the Laplace-integral converging absolutely for $\operatorname{Re} \lambda > 0$. Using (1.12) we get, for any $\alpha > 0$, the estimate

$$\sum_{j=2}^{\infty} |\hat{h}(\lambda)|^j \leq \sum_{j=2}^{\infty} \left(\frac{K}{|\lambda|} \right)^j = \frac{K^2}{|\lambda|(|\lambda| - K)}$$

for $\operatorname{Re} \lambda \geq \alpha$ and $|\lambda| > K$. This proves that the assumptions of Theorem A.8 are satisfied. Therefore $\hat{H}(\lambda)$ is a Laplace-transform of some function $H(t)$. As before we get (1.16). We decided to use Theorem A.9 for the proof of Theorem 1.5, because this in addition provided us an explicit representation of $Y(t)$ in terms of the matrix η .

3. For the proof of Theorem 1.5, b) one could also use Theorem A.6 on convolutions and just differentiate equation (1.17). This gives

$$\begin{aligned} 0 &= \dot{Y}(t) + \int_0^t \dot{Y}(t-\tau) \eta(-\tau) d\tau + \eta(-t) \\ &= \dot{Y}(t) + \int_{-t}^0 [dY(t+\tau)] \eta(\tau) + \eta(-t) \\ &= \dot{Y}(t) - \int_{-t}^0 Y(t+\tau) d\eta(\tau) = \dot{Y}(t) - \int_{-r}^0 Y_t(\theta) d\eta(\theta) \end{aligned}$$

a.e. on $t \geq 0$, which is equation (1.23). If we start with (1.22) we get (1.18).

In analogy to the theory of ordinary differential equations we introduce the following notions:

Definition 1.8 *The matrix $\Delta(\lambda)$ and the function $\det \Delta(\lambda)$ are called the **characteristic matrix** and the **characteristic function** of equation (1.1), respectively. $Y(t)$ is called the **fundamental matrix** of (1.1).*

1.4 Smooth initial functions

In case of an ordinary linear autonomous differential equation the derivatives of solutions are again solutions of the equation. This is in general not true in case of functional differential equations. A solution of (1.1) is continuously differentiable on $[0, \infty)$, but not necessarily differentiable at 0, even if the initial function is continuously differentiable on $[-r, 0]$.

Theorem 1.9 *Let $x(t; \phi)$ be a solution of equation (1.1). Then $x(t; \phi)$ has a continuous derivative on $[-r, \infty)$ if and only if*

(i) $\phi \in C^1([-r, 0], \mathbb{C}^n)$,

(ii) $\dot{\phi}(0) = L(\phi)$.

Moreover, if conditions (i) and (ii) hold, then

$$\dot{x}(t; \phi) = x(t; \dot{\phi}), \quad t \geq -r. \quad (1.24)$$

Proof. Suppose that (i) is true. Then integration by parts gives

$$\begin{aligned} p(\lambda; \phi) &= \phi(0) + \frac{1}{\lambda} \int_{-r}^0 [d\eta(\theta)] \int_{\theta}^0 e^{\lambda(\theta-u)} \dot{\phi}(u) du \\ &\quad - \frac{1}{\lambda} \left(\int_{-r}^0 e^{\lambda\theta} d\eta(\theta) \right) \phi(0) + \frac{1}{\lambda} \int_{-r}^0 [d\eta(\theta)] \phi(\theta) \\ &= \frac{1}{\lambda} \left(\Delta(\lambda) \phi(0) + L(\phi) + \int_{-r}^0 [d\eta(\theta)] \int_{\theta}^0 e^{\lambda(\theta-u)} \dot{\phi}(u) du \right). \end{aligned} \quad (1.25)$$

If in addition (ii) is true, then

$$p(\lambda; \phi) = \frac{1}{\lambda} (\Delta(\lambda) \phi(0) + p(\lambda; \dot{\phi})).$$

This shows

$$\lambda \hat{x}(\lambda) - \phi(0) = \Delta^{-1}(\lambda) p(\lambda; \dot{\phi}), \quad (1.26)$$

where $\hat{x}(\lambda) = \Delta^{-1}(\lambda) p(\lambda; \phi)$ as before denotes the Laplace-transform of $x(t; \phi)$. Relation (1.26) and Theorem 1.4, b), show that $\lambda \hat{x}(\lambda) - \phi(0)$ is the Laplace-transform of $y(t) = x(t; \dot{\phi})$ which is exponentially bounded and continuous on $(0, \infty)$. Therefore we have

$$\begin{aligned} \lambda \int_0^{\infty} e^{-\lambda t} x(t; \phi) dt - \phi(0) &= \lambda x^*(\lambda) - \phi(0) \\ &= \int_0^{\infty} e^{-\lambda t} y(t) dt = \lambda \int_0^{\infty} e^{-\lambda t} \left(\int_0^t y(\tau) d\tau \right) dt \end{aligned}$$

for $\operatorname{Re} \lambda$ sufficiently large, which implies (note that $x(t; \phi)$ is continuous)

$$x(t; \phi) - \phi(0) = \int_0^t y(\tau) d\tau, \quad t \geq 0.$$

This shows that $x(t; \phi)$ has a continuous derivative on $[0, \infty)$. On the other hand relation (1.26) shows that

$$y(t) = x(t; \dot{\phi}) \quad \text{a.e. on } [0, \infty).$$

Since solutions of equation (1.8) are continuous on $[-r, \infty)$, this proves that $x(t; \phi)$ has a continuous derivative on $[-r, \infty)$ and

$$\dot{x}(t; \phi) = x(t; \dot{\phi}), \quad t \geq -r.$$

Now suppose that $\dot{x}(t; \phi)$ exists on $[-r, \infty)$ and is continuous. This implies $\phi \in C^1([-r, 0], \mathbb{R}^n)$, of course. By continuity of $\dot{x}(t; \phi)$ at $t = 0$ we get $\dot{\phi}(0) = \dot{x}(0-; \phi) = \dot{x}(0+; \phi) = L(\phi)$. ■

Remarks. 1. Conditions (i) and (ii) characterize the domain of the infinitesimal generator \mathcal{A} corresponding to the solution semigroup $T(t)$, $t \geq 0$, associated with equation (1.1) (see Theorem 1.23).

2. Since $\mathcal{A}\phi = \dot{\phi}$ for $\phi \in \operatorname{dom} \mathcal{A}$, relation (1.24) means

$$\mathcal{A}T(t)\phi = T(t)\mathcal{A}\phi, \quad t \geq 0, \quad \phi \in \operatorname{dom} \mathcal{A},$$

which is well known for C_0 -semigroups.

1.5 The variation of constants formula

In this section we prove a representation formula for $x(t; \phi)$ resp. $x(t; \phi, f)$ in terms of the fundamental matrix and the data η , ϕ and f .

Lemma 1.10 *The function*

$$\hat{g}(\lambda) = - \int_{-r}^0 [d\eta(\theta)] (e_0(\lambda) * \phi)(\theta), \quad \lambda \in \mathbb{C},$$

is the Laplace-transform of the function

$$g(t) = \begin{cases} \int_{-r}^{-t} [d\eta(\theta)] \phi(t + \theta) & \text{for } 0 \leq t \leq r, \\ 0 & \text{for } t > r. \end{cases}$$

If we extend the definition of ϕ by $\phi(t) = 0$ for $t > 0$, then

$$g(t) = L(\phi_t) = \int_{-r}^0 [d\eta(\theta)] \phi(t + \theta) \tag{1.27}$$

for all $t \geq 0$ with the exception of an at most countable subset of $[0, r]$ (in fact the subset where $\eta(-\theta)$ is discontinuous).

Proof. The representation (1.27) of g follows from the fact that, for $\phi(0) \neq 0$ and $0 \leq t \leq r$,

$$\int_{-r}^{-t} [d\eta(\theta)]\phi(t + \theta) = \int_{-r}^0 [d\eta(\theta)]\phi(t + \theta)$$

provided η is continuous at $-t$. If $\phi(0) = 0$, then (1.27) holds for all $t \geq 0$.

Using Fubini's theorem we get

$$\begin{aligned} - \int_{-r}^0 [d\eta(\theta)](e_0(\lambda) * \phi)(\theta) &= \int_{-r}^0 [d\eta(\theta)] \int_0^{-\theta} e^{-\lambda\tau} \phi(\tau + \theta) d\tau \\ &= \int_0^r e^{-\lambda\tau} \int_{-\tau}^{-\tau} [d\eta(\theta)]\phi(\tau + \theta) d\tau = \int_0^\infty e^{-\lambda\tau} g(\tau) d\tau. \end{aligned}$$

■

Theorem 1.11 (Variation of Constants Formula) *The solution of problem (1.1), (1.2) is given by*

$$x(t; \phi) = Y(t)\phi(0) + \int_0^t Y(t - \tau)L(\phi_\tau) d\tau, \quad t \geq 0, \quad (1.28)$$

where $L(\phi_\tau)$ is defined in Lemma 1.10. The upper limit of the integral can be replaced by $\min(t, r)$.

Proof. The Laplace-transform of $x(t; \phi)$ is given by

$$\hat{x}(\lambda) = \Delta^{-1}(\lambda)p(\lambda; \phi) = \Delta^{-1}(\lambda)\phi(0) - \Delta^{-1}(\lambda) \int_{-r}^0 [d\eta(\theta)](e_0(\lambda) * \phi)(\theta).$$

From this (1.28) follows by using Lemma 1.10. For the application of the convolution theorem (Theorem A.7) we have to note that the Laplace-integrals of $Y(t)$ and $L(\phi_t)$ are absolutely convergent in some right half plane. ■

For fixed $t \geq 0$, $\phi \rightarrow \int_0^t Y(t - \tau)L(\phi_\tau) d\tau$ defines a bounded linear functional $\mathcal{C} \rightarrow \mathbb{C}^n$, which according to Riesz' theorem must have a representation $\int_{-r}^0 [d_\theta\Phi(\theta, t)]\phi(\theta)$, where $\Phi(\theta, t)$, for fixed $t \geq 0$, is a function of bounded variation in θ .

Proposition 1.12 *For any $\phi \in \mathcal{C}$ we have*

$$\int_0^t Y(t - \tau)L(\phi_\tau) d\tau = \int_{-r}^0 [d_\theta\Phi(\theta, t)]\phi(\theta),$$

where

$$\Phi(\theta, t) = \int_0^t Y(t - \sigma)\eta(\theta - \sigma) d\sigma, \quad -r \leq \theta \leq 0, \quad t \geq 0.$$

Proof. In order to get the explicit expression for $\Phi(\theta, t)$ we apply the non-symmetric Fubini theorem by Cameron and Martin ([6], see also Theorem C.1) to the integral

$$\int_0^t Y(t - \tau)L(\phi_\tau) d\tau = \int_{\max(0, t-r)}^t \int_{t-r-\sigma}^0 [d_\tau \eta(\sigma - t + \tau)]\phi(\tau) d\sigma.$$

We define the functions

$$k(\sigma) = \begin{cases} \int_0^\sigma Y(\tau) d\tau & \text{for } \max(0, t-r) \leq \sigma \leq t, \\ k(t) & \text{for } \sigma \geq t, \\ k(\max(0, t-r)) & \text{for } \sigma \leq \max(0, t-r), \end{cases}$$

$$s(\tau) = \begin{cases} \phi(\tau) & \text{for } -r \leq \tau \leq 0, \\ 0 & \text{for } \tau > 0, \\ \phi(-r) & \text{for } \tau \leq -r, \end{cases}$$

$$p(\sigma, \tau) = \eta(\sigma - t + \tau) \quad \text{for } \sigma, \tau \in \mathbb{R}.$$

We also change, for this proof the definition of η at points of discontinuity in $[-r, 0)$ such that η is right-hand continuous on \mathbb{R} . Then we have

$$\int_0^t Y(t - \tau)L(\phi_\tau) d\tau = \int_{-\infty}^{\infty} \left[\int_{-\infty}^{\infty} s(\tau) d_\tau p(\sigma, \tau) \right] dk(\sigma).$$

It is clear that the function $s(\tau)$ is Borel-measurable on \mathbb{R} , k is of bounded variation on bounded intervals and $\tau \rightarrow p(\sigma, \tau)$ is of bounded variation on bounded intervals for all $\sigma \in \mathbb{R}$. Borel-measurability of p on \mathbb{R}^2 follows from Borel-measurability of the mappings $(\sigma, \tau) \rightarrow \sigma + \tau - t$ on \mathbb{R}^2 and η on \mathbb{R} . In order to verify condition (i) of Theorem C.1 we have to investigate

$$V(\sigma, \tau) = \int_0^\tau |d_\nu p(\sigma, \nu)| = \int_{\sigma-t}^{\sigma-t+\tau} |d\eta(\theta)| = \text{var}_{[\sigma-t, \sigma-t+\tau]} \eta \quad \text{for } \tau \geq 0,$$

$$V(\sigma, \tau) = - \int_0^\tau |d_\nu p(\sigma, \nu)| = -\text{var}_{[\sigma-t+\tau, \sigma-t]} \eta \quad \text{for } \tau < 0.$$

By definition of k we get

$$\int_{-\infty}^{\infty} V(\sigma, \tau) |dk(\sigma)| = \int_{\max(0, t-r)}^t V(\sigma, \tau) |Y(\sigma)| d\sigma < \infty, \quad t \in \mathbb{R}.$$

This shows that condition (i) of Theorem C.1 holds. We also have

$$\int_{-\infty}^{\infty} |s(\tau)| |d_{\tau}p(\sigma, \tau)| \leq \|\phi\| \text{var}_{[-r,0]}\eta, \quad \sigma \in \mathbb{R},$$

and

$$\begin{aligned} \int_{-\infty}^{\infty} \int_{-\infty}^{\infty} |s(\tau)| |d_{\tau}p(\sigma, \tau)| |dk(\sigma)| \\ \leq \|\phi\| \text{var}_{[-r,0]}\eta \int_{\max(0,t-r)}^t |Y(\tau)| d\tau < \infty, \end{aligned}$$

i.e., also condition (ii) of Theorem C.1 is satisfied. Therefore we get

$$\begin{aligned} \int_0^t Y(t-\tau)L(\phi_{\tau}) d\tau &= \int_{-\infty}^{\infty} \left[d_{\tau} \int_{-\infty}^{\infty} [dk(\sigma)]p(\sigma, \tau) \right] s(\tau) \\ &= \int_{-r}^0 \left[d_{\tau} \int_{\max(0,t-r)}^t Y(\sigma)\eta(\sigma-t+\tau) d\sigma \right] \phi(\tau). \end{aligned}$$

This proves

$$\Phi(\theta, t) = \int_{\max(0,t-r)}^t Y(\sigma)\eta(\sigma-t+\theta) d\sigma = \int_0^{\min(t,r)} Y(t-\sigma)\eta(\theta-\sigma) d\sigma$$

for $-r \leq \theta \leq 0$ and $t \geq 0$. The upper limit $\min(t, r)$ in the second integral can be replaced by t . One easily checks that the resulting function $\Phi(\theta, t)$ would differ only by a constant, which does not matter. ■

We next turn to the nonhomogeneous problem (1.3), (1.4). It is sufficient to consider the case $\phi = 0$ only. For any $t_1 > 0$ we define

$$f(t; t_1) = \begin{cases} f(t) & \text{for } 0 \leq t \leq t_1, \\ 0 & \text{for } t > t_1. \end{cases}$$

Instead of equation (1.3) we consider for the moment

$$\dot{x}(t) = L(x_t) + f(t; t_1), \quad t \geq 0. \quad (1.29)$$

The estimates (1.8) and (1.9) imply

$$\begin{aligned} |x(t; 0, f(\cdot; t_1))| &\leq \int_0^{t_1} |f(\tau)| d\tau e^{\ell t}, \quad t \geq 0, \\ |\dot{x}(t; 0, f(\cdot; t_1))| &\leq \ell \int_0^{t_1} |f(\tau)| d\tau e^{\ell t}, \quad t \geq 0. \end{aligned}$$

Therefore the Laplace-transforms of $x(t) = x(t; 0, f(\cdot, t_1))$ and $\dot{x}(t)$ exist, the Laplace-integrals converging absolutely for $\operatorname{Re} \lambda > \ell$. Taking Laplace-transforms on both sides of equation (1.29) we get

$$\hat{x}(\lambda) = \Delta^{-1}(\lambda)\hat{f}(\lambda; t_1), \quad (1.30)$$

where $\hat{f}(\lambda; t_1) = \int_0^{t_1} e^{-\lambda t} f(t) dt$. This implies

$$x(t) = \int_0^t Y(t - \tau) f(\tau; t_1) d\tau, \quad t \geq 0.$$

Since $x(t; 0, f(\cdot, t_1)) = x(t; 0, f)$ for $0 \leq t \leq t_1$ and $t_1 > 0$ was arbitrary, we have proved the following theorem:

Theorem 1.13 *For any $\phi \in \mathcal{C}$ and $f \in L_{\text{loc}}^1(0, \infty; \mathbb{C}^n)$, the solution of problem (1.3), (1.4) is given by*

$$x(t; \phi, f) = x(t; \phi) + \int_0^t Y(t - \tau) f(\tau) d\tau, \quad t \geq 0. \quad (1.31)$$

Remark. Theorem 1.7, b) implies that, for any $a \in \mathbb{C}^n$, the function $x(t; a) = Y(t)a$, $t \geq -r$, is the unique solution of

$$\begin{aligned} \dot{x}(t) &= L(x_t) \quad \text{a.e. on } t \geq 0, \\ x(0) &= a \quad \text{and} \quad x(t) = 0 \quad \text{for } -r \leq t < 0. \end{aligned} \quad (1.32)$$

Therefore formula (1.28) can be viewed as the variation of constants formula for the nonhomogeneous problem

$$\begin{aligned} \dot{x}(t) &= L(x_t) + f(t) \quad \text{a.e. on } t \geq 0, \\ x(0) &= a \quad \text{and} \quad x(t) = 0 \quad \text{for } -r \leq t < 0, \end{aligned} \quad (1.33)$$

where $a = \phi(0)$ and $f(t) = L(\phi_t)$, $t \geq 0$.

Formula (1.28) also shows that the solution $x(t; \phi)$ is the sum of two functions. One is the solution of (1.32) with $a = \phi(0)$ and therefore is influenced only by $\phi(0)$, the other is the solution of (1.33) with $a = 0$ and $f(t) = L(\phi_t)$ and depends only on the past history $\phi|_{[-r, 0]}$.

1.6 The Spectrum

As we have seen in Section 1.3 the Laplace-integral for any solution $x(t) = x(t; \phi)$ of (1.1), (1.2) is absolutely convergent for $\operatorname{Re} \lambda > \ell$ (see Proposition 1.4). Therefore the complex inversion formula (cf. Theorem A.10) is applicable for any $\gamma > \ell$ and gives

$$x(t; \phi) = \int_{(\gamma)} e^{\lambda t} \Delta^{-1}(\lambda) p(\lambda; \phi) d\lambda, \quad t > 0. \quad (1.34)$$

For $t = 0$ the integral gives $\frac{1}{2}\phi(0)$ and zero for $t < 0$. Here and in the following we use the notation

$$\int_{(\gamma)} f(\lambda) d\lambda = \frac{1}{2\pi i} \lim_{T \rightarrow \infty} \int_{-T}^T f(\gamma + i\tau) d\tau.$$

We shall show in the next section that instead of taking $\gamma > \ell$ in (1.34) we can choose any $\gamma > \sup\{\operatorname{Re} \lambda \mid \Delta^{-1}(\lambda)p(\lambda; \phi) \text{ has a pole at } \lambda\}$. Since the poles of $\Delta^{-1}(\lambda)p(\lambda; \phi)$ occur under the zeros of $\det \Delta(\lambda)$, we shall investigate first the location of these zeros.

Definition 1.14 *The set $\sigma(L) = \{\lambda \in \mathbb{C} \mid \det \Delta(\lambda) = 0\}$ is called the **spectrum** of equation (1.1) and $\rho(L) = \mathbb{C} \setminus \sigma(L)$ is the **resolvent set** of equation (1.1).*

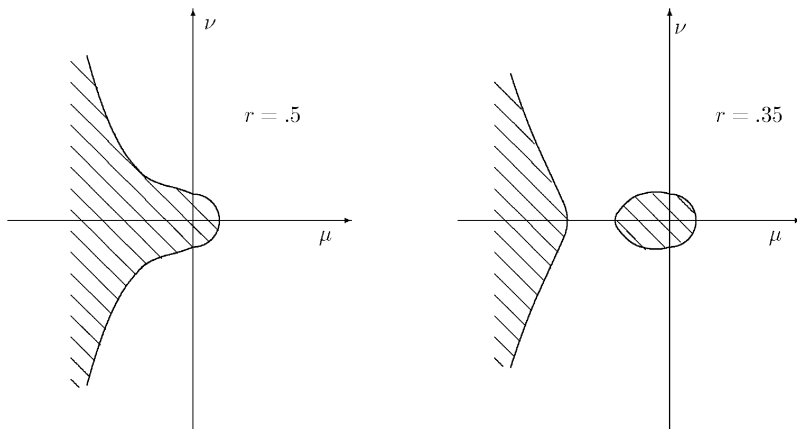

Figure 1

We first state some basic facts about $\sigma(L)$:

Proposition 1.15 a) $\sigma(L)$ is non-empty and all points of $\sigma(L)$ are isolated in \mathbb{C} . If $\sigma(L)$ is finite, then $\det \Delta(\lambda)$ is a polynomial in λ of degree n .

b) If $\lambda_0 \in \sigma(L)$ is a zero of $\det \Delta(\lambda)$ with multiplicity k_0 , then λ_0 is pole of some order κ_0 for $\Delta^{-1}(\lambda)$ (i.e., λ_0 is pole of at least one element of $\Delta^{-1}(\lambda)$ and κ_0 is the maximal order occurring). Moreover, we have

$$0 < \kappa_0 \leq k_0.$$

c) There exists a constant $\rho > 0$ such that (see the shaded areas in Figure 1)

$$\sigma(L) \subset \{\lambda \mid \operatorname{Re} \lambda \geq 0 \text{ and } |\lambda| \leq \rho\} \cup \{\lambda \mid \operatorname{Re} \lambda < 0 \text{ and } |\lambda|e^{r\operatorname{Re} \lambda} \leq \rho\}.$$

Proof. a) Since $\det \Delta(\lambda)$ is an entire function, the elements of $\sigma(L)$ are isolated points and zeros of finite multiplicity. Let $\lambda_0 \in \sigma(L)$ be a zero of multiplicity k_0 . From $\Delta^{-1}(\lambda) = \frac{1}{\det \Delta(\lambda)} \text{adj} \Delta(\lambda)$ it is clear that λ_0 is a pole of order $\kappa_0 \leq k_0$, because the elements of $\text{adj} \Delta(\lambda)$ are entire functions. We have to prove that λ_0 is indeed a pole for $\Delta^{-1}(\lambda)$. Suppose that $\Delta^{-1}(\lambda)$ is holomorphic at λ_0 . Then this is also true for $\det \Delta^{-1}(\lambda)$ and $\det \Delta(\lambda) \det \Delta^{-1}(\lambda)$. This leads to the contradiction $0 = \det \Delta(\lambda_0) \det \Delta^{-1}(\lambda_0) = \lim_{\lambda \rightarrow \lambda_0} \det \Delta(\lambda) \det \Delta^{-1}(\lambda) = 1$.

b) We may write

$$\det \Delta(\lambda) = \lambda^n + \alpha_{n-1}(\lambda)\lambda^{n-1} + \cdots + \alpha_1(\lambda)\lambda + \alpha_0(\lambda), \quad (1.35)$$

where each $\alpha_k(\lambda)$ is a finite sum of products of at most n of the functions $\int_{-r}^0 e^{\lambda\theta} d\eta_{ij}(\theta)$, $i, j = 1, \dots, n$. The estimate (1.11) therefore implies that there exists a constant $\delta > 0$ such that

$$|\alpha_k(\lambda)| \leq \begin{cases} \delta & \text{for } \text{Re } \lambda \geq 0, \\ e^{-rn \text{Re } \lambda} \delta & \text{for } \text{Re } \lambda < 0, \end{cases} \quad (1.36)$$

$k = 0, \dots, n-1$. Therefore we have the estimates

$$|\det \Delta(\lambda)| \geq |\lambda|^n \left(1 - \delta \sum_{k=1}^n |\lambda|^{-k}\right) \quad \text{for } \text{Re } \lambda \geq 0$$

and

$$\begin{aligned} |\det \Delta(\lambda)| &\geq |\lambda|^n \left(1 - \delta \sum_{k=1}^n e^{-rn \text{Re } \lambda} |\lambda|^{-k}\right) \\ &\geq |\lambda|^n \left(1 - \delta \sum_{k=1}^n (e^{rn \text{Re } \lambda} |\lambda|)^{-k}\right) \quad \text{for } \text{Re } \lambda < 0. \end{aligned}$$

Note that $e^{-n \text{Re } \lambda} > 1$ for $\text{Re } \lambda < 0$. If $|\lambda| > \rho$ for $\text{Re } \lambda \geq 0$ and $|\lambda| e^{rn \text{Re } \lambda} > \rho$ for $\text{Re } \lambda < 0$ with $\rho > 0$ satisfying $\sum_{k=1}^n \rho^{-k} = 1/\delta$, then $|\det \Delta(\lambda)| > 0$. If we set $\lambda = \mu + i\nu$, μ, ν real, then we have

$$\nu = \pm \rho e^{-rn\mu} \left(1 - \frac{\mu^2}{\rho^2} e^{2rn\mu}\right)^{1/2}, \quad \mu < 0,$$

for $|\lambda| e^{rn \text{Re } \lambda} = \rho$. In Figure 1 we show this curve for $\rho = 1$ and $r = .5$ resp. $r = .35$. We also see that ν behaves like $\pm \rho e^{-rn\mu}$ as $\mu \rightarrow -\infty$.

c) It remains to prove the result for finite $\sigma(L)$. Suppose that $\sigma(L)$ is empty or finite. Using (1.36) and the representation (1.35) for $\det \Delta(\lambda)$ we get

$$|\det \Delta(\lambda)| \leq (|\lambda|^n + \cdots + |\lambda| + 1)e^{rn|\lambda|}$$

for $\lambda \in \mathbb{C}$, which shows that $\det \Delta(\lambda)$ is a function of exponential type (see Definition B.1). Therefore the assumption on $\sigma(L)$ implies (cf. Theorem B.7)

$$\det \Delta(\lambda) = p(\lambda)e^{\alpha\lambda},$$

where $p(\lambda)$ is a polynomial of degree ≥ 0 and $\alpha \in \mathbb{C}$. Taking absolute values we get

$$e^{\operatorname{Re}(\alpha\lambda)} = \frac{|\det \Delta(\lambda)|}{|p(\lambda)|}, \quad \lambda \notin \sigma(L).$$

This together with (1.36) implies

$$\left(|\lambda|^n - \delta \sum_{j=0}^{n-1} |\lambda|^j\right) |p(\lambda)|^{-1} \leq e^{\operatorname{Re}(\alpha\lambda)} \leq \left(|\lambda|^n + \delta \sum_{j=0}^{n-1} |\lambda|^j\right) |p(\lambda)|^{-1} \quad (1.37)$$

for $\operatorname{Re} \lambda \geq 0$ and $|\lambda|$ sufficiently large. With $\sigma = \arg \alpha$ we choose $\lambda_k = ke^{i\zeta_k}$ where $\zeta_k = -\sigma + \pi/2$ or $\zeta_k = -\sigma - \pi/2$ such that $\operatorname{Re}(\alpha\lambda_k) = 0$ and $\operatorname{Re} \lambda_k \geq 0$. For $k \rightarrow \infty$ we see that (1.37) is only possible if $p(\lambda)$ is a polynomial of degree n . Therefore $\sigma(L)$ is not empty. Suppose α is not real. Then (1.37), for $\lambda = i\omega$, ω real, gives

$$e^{-\omega \operatorname{Im} \alpha} \leq \left(|\omega|^n + \delta \sum_{j=0}^{n-1} |\omega|^j\right) \frac{1}{|p(i\omega)|}.$$

The right-hand side of this inequality is bounded for $|\omega| \geq n_0$, n_0 sufficiently large, whereas the left-hand side is not. Thus α has to be real. But (1.37) implies that

$$\lim_{\rho \rightarrow \infty} e^{\alpha\rho} = \frac{1}{|p_n|},$$

where $p_n \neq 0$ is the coefficient of λ^n in $p(\lambda)$. Thus we have $\alpha = 0$ and $p_n = 1$. ■

Define the matrix $\eta_0 = (\eta_{ij}^0)$ by $\eta_0(\theta) = \eta(\theta)$ for $\theta < 0$ and by $\eta_0(0) = \eta(0-)$. We set $A_0 = -\eta(0-)$. Then

$$\int_{-r}^0 e^{\lambda\theta} d\eta(\theta) = A_0 + \int_{-r}^0 e^{\lambda\theta} d\eta_0(\theta).$$

In view of Proposition 1.15, a), the question arises if $\det \Delta(\lambda) = \det(\lambda I - A_0)$ provided $\sigma(L)$ is finite. We can prove this under an additional assumption on η :

Proposition 1.16 *Assume that there exists a $\delta > 0$ such that $\eta_0(\theta) = \eta_0(-\delta)$ for $\theta \in [-\delta, 0]$. If $\sigma(L)$ is finite, then*

$$\det \Delta(\lambda) = \det(\lambda I - A_0).$$

Proof. The coefficients $\alpha_j(\lambda)$ in (1.35) can be written as

$$\alpha_j(\lambda) = a_j + \beta_j(\lambda), \quad j = 0, \dots, n-1, \quad (1.38)$$

where the a_j are the coefficients of $\det(\lambda I - A_0)$ and the $\beta_j(\lambda)$ are finite sums of finite products involving elements of A_0 and of $\int_{-r}^0 e^{\lambda\theta} d\eta_0(\theta)$. In each product at least one factor is of the form $\int_{-r}^0 e^{\lambda\theta} d\eta_{ij}^0(\theta)$. The assumption on η_0 implies

$$\left| \int_{-r}^0 e^{\rho\theta} d\eta_{ij}^0(\theta) \right| \leq e^{-\rho\delta} \text{var}_{[-r,0]} \eta_{ij}^0, \quad i, j = 1, \dots, n, \quad \rho > 0. \quad (1.39)$$

From

$$q(\lambda) = \beta_{n-1}(\lambda)\lambda^{n-1} + \dots + \beta_1(\lambda)\lambda + \beta_0(\lambda) = \det \Delta(\lambda) - \det(\lambda I - A_0)$$

we see that $q(\lambda)$ is a polynomial of degree $\leq n-1$. On the other hand the estimate (1.39) implies that, for a constant $K > 0$,

$$|q(\rho)| \leq K e^{-\rho\delta} \rho^{n-1} \quad \text{for } \rho \geq 1.$$

This implies that $q(\lambda)$ is the zero polynomial. \blacksquare

An immediate and important consequence of Proposition 1.15, c), and the fact that $\sigma(L)$ cannot have an accumulation point in \mathbb{C} is the following result:

Corollary 1.17 *For any $\alpha \in \mathbb{R}$ the set*

$$\sigma(L) \cap \{\lambda \in \mathbb{C} \mid \text{Re } \lambda \geq \alpha\}$$

is finite.

We shall need the following estimates:

Lemma 1.18 *Let $\alpha \in \mathbb{R}$ be given. Then the following is true:*

a) *There exist positive constants $K = K(\alpha)$ and $\beta = \beta(\alpha)$ such that*

$$|\Delta^{-1}(\lambda)| \leq \frac{K}{|\lambda|} \quad \text{for } |\lambda| \geq \beta \text{ and } \text{Re } \lambda \geq \alpha.$$

b) *There exists a positive constant $M = M(\alpha)$ such that*

$$|p(\lambda; \phi)| \leq M \|\phi\| \quad \text{for } \text{Re } \lambda \geq \alpha \text{ and } \phi \in \mathcal{C}.$$

Consequently, $\phi \rightarrow \hat{x}(\lambda; \phi) = \Delta^{-1}(\lambda)p(\lambda; \phi)$ defines a bounded linear functional $\mathcal{C} \rightarrow \mathbb{C}^n$ for all $\lambda \notin \sigma(L)$.

Proof. a) The estimate (1.36) shows that for some constant $\sigma_0 = \sigma_0(\alpha) > 0$ we have $|\alpha_k(\lambda)| \leq \sigma_0$ for $\operatorname{Re} \lambda \geq \alpha$ and $k = 0, \dots, n-1$. Then

$$|\det \Delta(\lambda)| \geq |\lambda|^n \left(1 - \sigma_0 \sum_{k=1}^n |\lambda|^{-k} \right) \quad \text{for } \operatorname{Re} \lambda \geq \alpha.$$

Therefore there is a constant $\beta = \beta(\sigma_0)$ such that

$$|\det \Delta(\lambda)| \geq \frac{1}{2} |\lambda|^n \quad \text{for } \operatorname{Re} \lambda \geq \alpha \text{ and } |\lambda| \geq \beta.$$

From (1.11) we infer that there exists a constant $K = K(\alpha)$ such that

$$|\operatorname{adj} \Delta(\lambda)| \leq \frac{K}{2} |\lambda|^{n-1} \quad \text{for } \operatorname{Re} \lambda \geq \alpha \text{ and } |\lambda| \geq \beta.$$

Therefore we have

$$|\Delta^{-1}(\lambda)| \leq \frac{K}{|\lambda|} \quad \text{for } \operatorname{Re} \lambda \geq \alpha \text{ and } |\lambda| \geq \beta.$$

b) Indeed,

$$|p(\lambda; \phi)| \leq \|\phi\| + \ell \|e_0(\lambda) * \phi\|$$

for all $\lambda \in \mathbb{C}$ and $\phi \in \mathcal{C}$. Furthermore,

$$|(e_0(\lambda) * \phi)(\theta)| \leq \|\phi\| \int_{\theta}^0 e^{\alpha(\theta-\tau)} d\tau \leq \begin{cases} \min(r, 1/\alpha) \|\phi\| & \text{for } \alpha \geq 0, \\ r e^{|\alpha|r} \|\phi\| & \text{for } \alpha < 0, \end{cases}$$

for $\operatorname{Re} \lambda \geq \alpha$ (note that $\theta - \tau \leq 0$). This proves that, for $\operatorname{Re} \lambda \geq \alpha$,

$$|p(\lambda; \phi)| \leq \begin{cases} (1 + \ell \min(r, 1/\alpha)) \|\phi\| & \text{for } \alpha \geq 0, \\ (1 + \ell r e^{|\alpha|r}) \|\phi\| & \text{for } \alpha < 0. \end{cases} \quad (1.40)$$

■

Definition 1.19 The number $\omega_L = \sup\{\operatorname{Re} \lambda \mid \lambda \in \sigma(L)\}$ is called the **exponential type of equation** (1.1). For any $\phi \in \mathcal{C}$, the number

$$\omega_{L,\phi} = \sup\{\operatorname{Re} \lambda \mid \lambda \text{ is a pole of } \Delta^{-1}(\lambda)p(\lambda; \phi)\}$$

is called the **exponential type of the solution** $x(t; \phi)$ of (1.1), (1.2).

The names for ω_L and $\omega_{L,\phi}$ will be justified later (see Corollary 1.22). It is clear that $\omega_{L,\phi} \leq \omega_L$ for all $\phi \in \mathcal{C}$.

Proposition 1.20 a) For any $\gamma > \omega_L$,

$$Y(t) = \int_{(\gamma)} e^{\lambda t} \Delta^{-1}(\lambda) d\lambda \quad \text{for } t > 0. \tag{1.41}$$

b) For any $\gamma > \omega_{L,\phi}$,

$$x(t; \phi) = \int_{(\gamma)} e^{\lambda t} \Delta^{-1}(\lambda) p(\lambda; \phi) d\lambda \quad \text{for } t > 0. \tag{1.42}$$

Proof. We only prove part b). According to the definition of $\omega_{L,\phi}$ we have for all $T > 0$

$$\int_{\Gamma} e^{\lambda t} \Delta^{-1}(\lambda) p(\lambda; \phi) d\lambda = 0, \tag{1.43}$$

where Γ is the closed contour depicted in Figure 2.

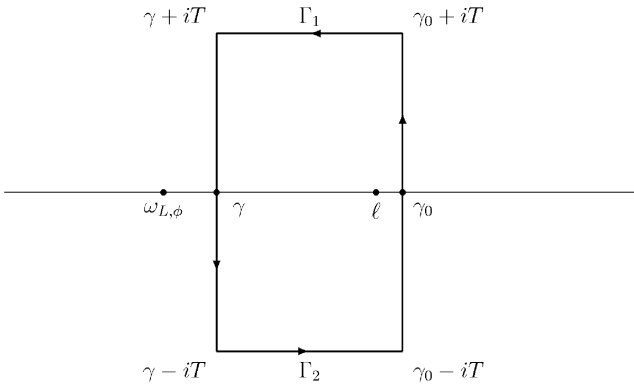

Figure 2

Of course, we have $\omega_{L,\phi} < \gamma \leq \gamma_0$ and $\ell < \gamma_0$. By Lemma 1.18 there exist positive constants \tilde{K} and $\tilde{\rho}$ such that

$$|e^{\lambda t} \Delta^{-1}(\lambda) p(\lambda; \phi)| \leq \frac{\tilde{K}}{|\lambda|}$$

for $\gamma \leq \text{Re } \lambda \leq \gamma_0$ and $|\text{Im } \lambda| \geq \tilde{\rho}$. This shows

$$\lim_{T \rightarrow \infty} \int_{\Gamma_i} e^{\lambda t} \Delta^{-1}(\lambda) p(\lambda; \phi) d\lambda = 0, \quad i = 1, 2, \tag{1.44}$$

where Γ_1 and Γ_2 are the horizontal parts of Γ (see Figure 2). By choice of γ_0 , the Laplace-integral for $x(t; \phi)$ is absolutely convergent for $\operatorname{Re} \lambda \geq \gamma_0$ and therefore (cf. Theorem A.10)

$$x(t; \phi) = \int_{(\gamma_0)} e^{\lambda t} \Delta^{-1}(\lambda) p(\lambda; \phi) d\lambda, \quad t > 0.$$

By (1.43) and (1.44) also $\int_{(\gamma)} e^{\lambda t} \Delta^{-1}(\lambda) p(\lambda; \phi) d\lambda$ exists and equals $x(t; \phi)$ for $t > 0$. This proves (1.42).

In the proof concerning $Y(t)$ we have to choose $\gamma_0 > \beta$, where β is the number appearing in Theorem 1.5. ■

We now are able to prove that the numbers ω_L and $\omega_{L,\phi}$ determine the exponential growth of $Y(t)$ and $x(t; \phi)$, respectively.

Theorem 1.21 a) *The number ω_L is the smallest number such that for any $\varepsilon > 0$ there exists a constant $K = K(\varepsilon) \geq 1$ such that*

$$|Y(t)| \leq K e^{(\omega_L + \varepsilon)t} \quad \text{for } t \geq 0. \quad (1.45)$$

b) *The number $\omega_{L,\phi}$ is the smallest number such that for any $\varepsilon > 0$ there exists a constant $\tilde{K} = \tilde{K}(\varepsilon) \geq 1$ such that for any $\psi \in \mathcal{C}$ with $\omega_{L,\psi} \leq \omega_{L,\phi}$*

$$|x(t; \psi)| \leq \tilde{K} \|\psi\| e^{(\omega_{L,\phi} + \varepsilon)t} \quad \text{for } t \geq 0. \quad (1.46)$$

There always exists a $\phi \in \mathcal{C}$ such that $\omega_{L,\phi} = \omega_L$.

Proof. Again we just prove b). We show first that $\omega_{L,\phi}$ cannot be replaced by a smaller number. Indeed, assume that (1.46) is true for a $\gamma < \omega_{L,\phi}$. Then, for $\varepsilon = (\omega_{L,\phi} - \gamma)/2$ we have $\gamma + \varepsilon < \omega_{L,\phi}$ and $|x(t; \phi)| \leq \tilde{K}(\varepsilon) \|\phi\| e^{(\gamma + \varepsilon)t}$, $t \geq 0$, which implies that the Laplace-integral for $x(t; \phi)$ converges absolutely for $\operatorname{Re} \lambda > \gamma$, a contradiction to the definition of $\omega_{L,\phi}$.

We now choose a $\psi \in \mathcal{C}$ with $\omega_{L,\psi} \leq \omega_{L,\phi}$. For $\varepsilon > 0$ we set $\omega_{L,\phi} + \varepsilon = \gamma$ and get from (1.42)

$$x(t; \psi) = \int_{(\gamma)} e^{\lambda t} \Delta^{-1}(\lambda) p(\lambda; \psi) d\lambda, \quad t > 0.$$

According to the identity

$$\begin{aligned} \Delta^{-1}(\lambda) p(\lambda; \psi) &= (\Delta^{-1}(\lambda) - (\lambda - \omega_{L,\phi})^{-1} I) p(\lambda; \psi) + (\lambda - \omega_{L,\phi})^{-1} p(\lambda; \psi) \\ &= (\lambda - \omega_{L,\phi})^{-1} \Delta^{-1}(\lambda) \left(-\omega_{L,\phi} I + \int_{-r}^0 e^{\lambda \theta} d\eta(\theta) \right) p(\lambda; \psi) \\ &\quad + (\lambda - \omega_{L,\phi})^{-1} p(\lambda; \psi) \end{aligned}$$

we have to estimate

$$I_1 = \int_{(\gamma)} e^{\lambda t} (\lambda - \omega_{L,\phi})^{-1} \Delta^{-1}(\lambda) \left(-\omega_{L,\phi} I + \int_{-r}^0 e^{\lambda \theta} d\eta(\theta) \right) p(\lambda; \psi) d\lambda$$

and

$$I_2 = \int_{(\gamma)} e^{\lambda t} (\lambda - \omega_{L,\phi})^{-1} p(\lambda; \psi) d\lambda.$$

By Lemma 1.18 and (1.11) there exist positive constants $K = K(\gamma)$, $M = M(\gamma)$, $N = N(\gamma)$ and β such that for $\lambda = \gamma + i\tau$

$$\begin{aligned} & \left| e^{\lambda t} (\lambda - \omega_{L,\phi})^{-1} \Delta^{-1}(\lambda) \left(-\omega_{L,\phi} I + \int_{-r}^0 e^{\lambda \theta} d\eta(\theta) \right) p(\lambda; \psi) \right| \\ & \leq e^{\gamma t} \frac{1}{|\tau|} \frac{K}{|\tau|} (|\omega_{L,\phi}| + N) M \|\psi\| = \frac{\tilde{K}}{\tau^2} \|\psi\| e^{\gamma t}, \quad |\tau| \geq \beta. \end{aligned}$$

This implies that

$$|I_1| \leq \kappa_1 \|\psi\| e^{\gamma t}, \quad t > 0, \quad (1.47)$$

where $\kappa_1 = \kappa_1(\gamma)$ is some positive constant. With respect to I_2 we observe that $(\lambda - \omega_{L,\phi})^{-1} \psi(0)$ is the Laplace-transform of $e^{\omega_{L,\phi} t} \psi(0)$ and $-(\lambda - \omega_{L,\phi})^{-1} L(e_0(\lambda) * \psi)$ is the Laplace-transform of the convolution $e^{\omega_{L,\phi} t} * L(\psi_t)$ (see Lemma 1.10). All Laplace-integrals are converging absolutely for $\operatorname{Re} \lambda > \omega_{L,\phi}$. For $e^{\omega_{L,\phi} t}$ this is trivial and for the convolution it is valid because it is true for both factors. Therefore we have

$$I_2 = \psi(0) e^{\omega_{L,\phi} t} + \int_0^t e^{\omega_{L,\phi}(t-\tau)} L(\psi_\tau) d\tau, \quad t \geq 0.$$

For the integral we get (note that $L(\psi_\tau) = 0$ for $\tau > r$)

$$\begin{aligned} \left| \int_0^t e^{\omega_{L,\phi}(t-\tau)} L(\psi_\tau) d\tau \right| & \leq \int_0^{\min(t,r)} e^{\omega_{L,\phi}(t-\tau)} |L(\psi_\tau)| d\tau \\ & \leq e^{\omega_{L,\phi} t} \int_0^r |L(\psi_\tau)| d\tau \leq \kappa_2 e^{\omega_{L,\phi} t} \|\psi\|, \end{aligned}$$

where κ_2 is a positive constant which does not depend on ψ . Therefore we get

$$|I_2| \leq e^{\omega_{L,\phi} t} \|\psi\| (1 + \kappa_2) \quad \text{for } t \geq 0. \quad (1.48)$$

Since $x(t; \psi) = I_1 + I_2$, the desired result follows from (1.47) and (1.48).

An easy calculation shows that $x(t) = e^{\lambda_0 t} b$ is a nontrivial solution of equation (1.1) if and only if $\det \Delta(\lambda_0) = 0$ and b is a nonzero solution of $\Delta(\lambda_0)b = 0$. Therefore, for any $\lambda_0 \in \sigma(L)$, we have at least one solution whose exponential type is $\operatorname{Re} \lambda_0$ (note that $\mathcal{L}(e^{\lambda_0 t}) = (\lambda - \lambda_0)^{-1}$). ■

Corollary 1.22 *We have*

$$\limsup_{t \rightarrow \infty} \frac{1}{t} \ln |Y(t)| = \omega_L$$

and, for any $\phi \in \mathcal{C}$,

$$\limsup_{t \rightarrow \infty} \frac{1}{t} \ln |x(t; \phi)| = \omega_{L, \phi}.$$

The proof of this corollary is an immediate consequence of Theorem 1.21.

1.7 The solution semigroup

For any $t \geq 0$ we define the operator $T(t) : \mathcal{C} \rightarrow \mathcal{C}$ by

$$T(t)\phi = x_t(\phi), \quad \phi \in \mathcal{C}.$$

From Proposition 1.3 (for $f \equiv 0$) we see that $T(t)$ is a bounded linear operator. Since $x_{t+s}(\phi) = x_t(x_s(\phi))$ for $t, s \geq 0$, we also have

$$T(t+s) = T(t)T(s), \quad t, s \geq 0,$$

i.e., the family $\mathcal{T} = (T(t))_{t \geq 0}$ is a semigroup. Since $x(t; \phi)$ is uniformly continuous on intervals $[-r, T]$, $T \geq -r$, it is clear that

$$\|x_t(\phi) - \phi\| = \sup_{-r \leq \theta \leq 0} |x(t + \theta; \phi) - \phi(\theta)| \rightarrow 0 \quad \text{as } t \downarrow 0,$$

which proves that \mathcal{S} is a \mathcal{C}_0 -semigroup.

Theorem 1.23 a) *The infinitesimal generator \mathcal{A} of \mathcal{S} is given by*

$$\begin{aligned} \operatorname{dom} \mathcal{A} &= \{\phi \in C^1(-r, 0; \mathbb{C}^n) \mid \phi'(0) = L(\phi)\}, \\ \mathcal{A}\phi &= \phi', \quad \phi \in \operatorname{dom} \mathcal{A}. \end{aligned} \tag{1.49}$$

b) *The spectrum $\sigma(\mathcal{A})$ of \mathcal{A} is all point spectrum and is given by*

$$\sigma(\mathcal{A}) = \sigma(L) = \{\lambda \in \mathbb{C} \mid \det \Delta(\lambda) = 0\}.$$

c) *The resolvent operator of \mathcal{A} is given by*

$$\psi_\lambda = (\lambda I - \mathcal{A})^{-1}\phi, \quad \phi \in \mathcal{C},$$

where

$$\begin{aligned}\psi_\lambda(\theta) &= \psi_\lambda(0)e^{\lambda\theta} + \int_\theta^0 e^{\lambda(\theta-s)}\phi(s) ds, \\ \psi_\lambda(0) &= \Delta(\lambda)^{-1}p(\lambda; \phi) = \hat{x}(\lambda; \phi).\end{aligned}$$

Proof. We first compute the resolvent operator for the operator defined by (1.49). The equation $(\lambda I - \mathcal{A})\psi_\lambda = \phi$, $\phi \in \mathcal{C}$, $\psi_\lambda \in \text{dom } \mathcal{A}$, implies $\psi'_\lambda(\theta) = \lambda\psi_\lambda(\theta) - \phi(\theta)$, $-r \leq \theta \leq 0$, and

$$\psi_\lambda(\theta) = \psi_\lambda(0)e^{\lambda\theta} + \int_\theta^0 e^{\lambda(\theta-s)}\phi(s) ds, \quad -r \leq \theta \leq 0.$$

The function ψ_λ is in $C^1(-r, 0; \mathbb{C}^n)$. We have to choose $\psi_\lambda(0)$ such that $\psi_\lambda \in \text{dom } \mathcal{A}$, i.e.,

$$\lambda\psi_\lambda(0) - \phi(0) = L(\psi_\lambda) = L(e^{\lambda \cdot} I)\psi_\lambda(0) + L\left(\int_\cdot^0 e^{\lambda(\cdot-s)}\phi(s) ds\right)$$

or, equivalently,

$$\Delta(\lambda)\psi_\lambda(0) = \phi(0) + L\left(\int_\cdot^0 e^{\lambda(\cdot-s)}\phi(s) ds\right) = p(\lambda; \phi).$$

This equation can be solved for $\psi_\lambda(0)$ if and only if $\det \Delta(\lambda) \neq 0$. In this case we have

$$\psi_\lambda(0) = \Delta(\lambda)^{-1}p(\lambda; \phi) = \hat{x}(\lambda; \phi).$$

From Lemma 1.18, b) we see that $\phi \rightarrow \psi_\lambda(0)$ defines a bounded linear functional $\mathcal{C} \rightarrow \mathbb{C}^n$. This implies that $\phi \rightarrow \psi_\lambda$ is a bounded linear operator $\mathcal{C} \rightarrow \mathcal{C}$. Therefore we have shown that $\lambda \in \sigma(\mathcal{A})$ if and only if $\det \Delta(\lambda) = 0$. Moreover, $\lambda \in \sigma(\mathcal{A})$ implies that $\lambda I - \mathcal{A}$ is not injective ($(\lambda I - \mathcal{A})\psi = 0$, $\psi \in \text{dom } \mathcal{A}$, is equivalent to $\psi(\theta) = \psi(0)e^{\lambda\theta}$, $-r \leq \theta \leq 0$, and $\Delta(\lambda)\psi(0) = 0$). Thus parts b) and c) are proved.

It remains to prove that \mathcal{A} is the infinitesimal generator of \mathcal{T} . For the moment let \mathcal{B} denote the infinitesimal generator of \mathcal{T} . Then we have (see for instance [28])

$$(\lambda I - \mathcal{B})^{-1}\phi = \int_0^\infty e^{-\lambda t}T(t)\phi dt, \quad \phi \in \mathcal{C}, \quad \text{Re } \lambda > \omega_L,$$

where the integral is understood as an improper Riemann integral. On the other hand a simple integration using also part c) shows that

$$\begin{aligned} \left(\int_0^\infty e^{-\lambda t} T(t) \phi dt \right) (\theta) &= \left(\int_0^\infty e^{-\lambda t} x_t(\phi) dt \right) (\theta) = \int_0^\infty e^{-\lambda t} x(t + \theta; \phi) dt \\ &= \int_\theta^0 e^{\lambda(\theta-s)} \phi(s) ds + e^{\lambda\theta} \int_0^\infty e_{\lambda t} x(t; \phi) dt \\ &= \hat{x}(\lambda; \phi) e^{\lambda\theta} + \int_\theta^0 e^{\lambda(\theta-s)} \phi(s) ds \\ &= ((\lambda I - \mathcal{A})^{-1} \phi)(\theta), \quad -r \leq \theta \leq 0, \operatorname{Re} \lambda > \omega_L. \end{aligned}$$

This proves $(\lambda I - \mathcal{A})^{-1} = (\lambda I - \mathcal{B})^{-1}$, $\operatorname{Re} \lambda > \omega_L$, i.e., $\mathcal{A} = \mathcal{B}$. ■

For the proof of $\mathcal{A} = \mathcal{B}$ we have also used the following lemma:

Lemma 1.24 *For any $\theta \in [-r, 0]$ we have*

$$\left(\int_0^\infty e^{-\lambda t} x_t(\phi) dt \right) (\theta) = \int_0^\infty e^{-\lambda t} x(t + \theta; \phi) dt, \quad \operatorname{Re} \lambda > \omega_L.$$

Proof. Let m be a bounded linear functional on \mathcal{C} which is represented by the vector μ of bounded variation on $[-r, 0]$,

$$m(\phi) = \int_{-r}^0 \phi(\theta) d\mu(\theta), \quad \phi \in \mathcal{C}.$$

Then we have

$$\begin{aligned} m \left(\int_0^\infty e^{-\lambda t} x_t(\phi) dt \right) &= \int_0^\infty m(e^{-\lambda t} x_t(\phi)) dt \\ &= \int_0^\infty \int_{-r}^0 x(t + \theta; \phi) d\mu(\theta) dt. \end{aligned}$$

It is not difficult to prove that $\theta \rightarrow \int_0^\infty e^{-\lambda t} x(t + \theta; \phi) dt$, $-r \leq \theta \leq 0$, is a function in \mathcal{C} . Using Fubini's theorem we get

$$\begin{aligned} m \left(\int_0^\infty e^{-\lambda t} x(t + \theta; \phi) dt \right) &= \int_{-r}^0 \int_0^\infty e^{-\lambda t} x(t + \theta; \phi) dt d\mu(\theta) \\ &= \int_0^\infty \int_{-r}^0 e^{-\lambda t} x(t + \theta; \phi) d\mu(\theta) dt. \end{aligned}$$

Thus we have shown that

$$m \left(\int_0^\infty e^{-\lambda t} x_t(\phi) dt \right) = m \left(\int_0^\infty e^{-\lambda t} x(t + \cdot; \phi) dt \right)$$

for all bounded linear functionals m on \mathcal{C} , which proves the result. ■

2. Eigenspaces

2.1 Generalized eigenspaces

Consider equation (1.1) with

$$L(\phi) = \int_{-r}^0 [d\eta(\theta)]\phi(\theta), \quad \phi \in \mathcal{C}.$$

A function $x(t) = e^{\lambda_0 t} b_0$, $\lambda_0 \in \mathbb{C}$, $b_0 \in \mathbb{C}^n$, is a solution of (1.1) if and only if

$$\det \Delta(\lambda_0) = 0 \quad \text{and} \quad \Delta(\lambda_0)b_0 = 0.$$

Similarly a function $x(t) = e^{\lambda_0 t} (b_0 + tb_1)$, $\lambda_0 \in \mathbb{C}$, $b_0, b_1 \in \mathbb{C}^n$, is a solution of (1.1) if and only if

$$t\Delta(\lambda_0)b_1 + \left(I - \int_{-r}^0 \theta e^{\lambda_0 \theta} d\eta(\theta) \right) b_1 + \Delta(\lambda_0)b_0 \equiv 0,$$

which in turn is equivalent to

$$\begin{aligned} \Delta(\lambda_0)b_1 &= 0, \\ \Delta(\lambda_0)b_0 + \Delta'(\lambda_0)b_1 &= 0 \end{aligned}$$

(observe that $\Delta'(\lambda_0) = I - \int_{-r}^0 \theta e^{\lambda_0 \theta} d\eta(\theta)$). In general we have:

Proposition 2.1 *Let $\lambda_0 \in \mathbb{C}$ and $b_j \in \mathbb{C}^n$, $j = 0, \dots, k$, be given. The function*

$$x(t) = e^{\lambda_0 t} \sum_{j=0}^k \frac{t^j}{j!} b_j \neq 0 \tag{2.1}$$

is a solution of (1.1) on \mathbb{R} if and only if

- (i) $\lambda_0 \in \sigma(L)$,
- (ii) $\tilde{\Delta}_{k+1}(\lambda_0)\tilde{b}_{k+1} = 0$, $\tilde{b}_{k+1} \neq 0$,

where

$$\tilde{\Delta}_{k+1}(\lambda_0) = \begin{pmatrix} \Delta(\lambda_0) & \frac{1}{1!}\Delta'(\lambda_0) & \cdots & \cdots & \frac{1}{k!}\Delta^{(k)}(\lambda_0) \\ 0 & \ddots & \ddots & & \vdots \\ \vdots & \ddots & \ddots & \ddots & \vdots \\ \vdots & & \ddots & \ddots & \frac{1}{1!}\Delta'(\lambda_0) \\ 0 & \cdots & \cdots & 0 & \Delta(\lambda_0) \end{pmatrix} \in \mathbb{C}^{n(k+1) \times n(k+1)},$$

$$\tilde{b}_{k+1} = \text{col}(b_0, \dots, b_k) \in \mathbb{C}^{n(k+1)}.$$

Definition 2.2 Let $\lambda_0 \in \sigma(L)$ be given. The subspace

$$P_{\lambda_0} = \left\{ \phi \in \mathcal{C} \mid \exists k \geq 0 : \phi(\theta) = e^{\lambda_0 \theta} \sum_{j=0}^k \frac{\theta^j}{j!} b_j, \quad -r \leq \theta \leq 0, \right. \\ \left. \text{where } \tilde{\Delta}_{k+1}(\lambda_0) \tilde{b}_{k+1} = 0 \right\}$$

is called the **generalized eigenspace** of (1.1) corresponding to λ_0 . A function $x(t)$ given by (2.1) with \tilde{b}_k satisfying (ii) of Proposition 2.1 is called a **generalized eigenfunction** of equation (1.1) corresponding to λ_0 .

For $\lambda_0 \in \sigma(L)$ let k_0 be the multiplicity of λ_0 as a root of $\det \Delta(\lambda)$ and κ_0 be the order of λ_0 as a pole of $\Delta^{-1}(\lambda)$. We know already that

$$0 < \kappa_0 \leq k_0.$$

We first show that in the definition of P_{λ_0} we can set $k = \kappa_0 - 1$.³

Proposition 2.3 Let $\lambda_0 \in \sigma(L)$ be given.

a) The generalized eigenspace of (1.1) corresponding to λ_0 is given by

$$P_{\lambda_0} = \left\{ \phi \in \mathcal{C} \mid \phi(\theta) = e^{\lambda_0 \theta} \sum_{j=0}^{\kappa_0-1} \frac{\theta^j}{j!} b_j, \quad -r \leq \theta \leq 0, \right. \\ \left. \text{where } \tilde{\Delta}_{\kappa_0}(\lambda_0) \tilde{b}_{\kappa_0} = 0 \right\}. \quad (2.2)$$

b) $\dim P_{\lambda_0} = n\kappa_0 - \text{rank } \tilde{\Delta}_{\kappa_0}(\lambda_0)$.

Proof. a) Assume that, for a $\phi \in P_{\lambda_0}$, we have $k \geq \kappa_0$, i.e.,

$$\phi(\theta) = e^{\lambda_0 \theta} \sum_{j=0}^k \frac{\theta^j}{j!} b_j, \quad \tilde{\Delta}_{k+1}(\lambda_0) \tilde{b}_{k+1} = 0.$$

The solution $x(t; \phi)$ is given by

$$x(t; \phi) = e^{\lambda_0 t} \sum_{j=0}^k \frac{t^j}{j!} b_j.$$

The Laplace-transform of $x(t; \phi)$ is

$$\hat{x}(\lambda; \phi) = \sum_{j=0}^k \frac{1}{(\lambda - \lambda_0)^{j+1}} b_j.$$

³Below we shall prove that κ_0 cannot be replaced by a smaller number (see Corollary 2.9).

Since λ_0 can be a pole of $\hat{x}(\lambda; \phi)$ of order at most κ_0 (observe that $\hat{x}(\lambda; \phi) = \Delta^{-1}(\lambda)p(\lambda; \phi)$), we must have

$$b_{\kappa_0} = b_{\kappa_0+1} = \dots = b_k = 0,$$

i.e., $\tilde{b}_k = \text{col}(b_0, \dots, b_{\kappa_0-1}, 0, \dots, 0)$. From $\tilde{\Delta}_{k+1}(\lambda_0)\tilde{b}_{k+1} = 0$ we immediately get

$$\tilde{\Delta}_{\kappa_0}(\lambda_0)\tilde{b}_{\kappa_0} = 0.$$

If $\phi \in P_{\lambda_0}$ is defined with $k < \kappa_0 - 1$, we define $b_{k+1} = b_{k+2} = \dots = b_{\kappa_0-1} = 0$. From $\tilde{\Delta}_{k+1}(\lambda_0)\tilde{b}_{k+1} = 0$ we get that also

$$\tilde{\Delta}_{\kappa_0}(\lambda_0)\tilde{b}_{\kappa_0} = 0.$$

b) Let $\phi_i(\theta) = e^{\lambda_0\theta} \sum_{j=0}^{\kappa_0-1} \frac{\theta^j}{j!} b_j^{(i)}$, $i = 1, \dots, m$, be elements in P_{λ_0} and choose $\alpha_1, \dots, \alpha_m \in \mathbb{C}$. The equation $\sum_{i=1}^m \alpha_i \phi_i = 0$ is equivalent to

$$\sum_{j=0}^{\kappa_0-1} \frac{\theta^j}{j!} \sum_{i=1}^m \alpha_i b_j^{(i)} \equiv 0,$$

which by linear independence of the functions $1, \theta, \theta^2/2!, \dots, \theta^{\kappa_0-1}/(\kappa_0-1)!$ is in turn equivalent to

$$\sum_{i=1}^m \alpha_i b_j^{(i)} = 0 \quad \text{for } j = 0, \dots, \kappa_0 - 1.$$

The last equations are equivalent to

$$\sum_{i=1}^m \alpha_i \tilde{b}_{\kappa_0}^{(i)} = 0.$$

This proves that the elements $\phi_1, \dots, \phi_m \in P_{\lambda_0}$ are linearly independent if and only if the vectors $\tilde{b}_{\kappa_0}^{(1)}, \dots, \tilde{b}_{\kappa_0}^{(m)} \in \ker \tilde{\Delta}_{\kappa_0}(\lambda_0)$ are linearly independent. The result on $\dim P_{\lambda_0}$ follows immediately. ■

In order to determine $\text{rank } \tilde{\Delta}_{\kappa_0}(\lambda_0)$ we have to use an elementary divisor theory for holomorphic matrices. We start with a fundamental theorem.

Theorem 2.4 *Let $K(\lambda)$ be an $n \times n$ -matrix which is holomorphic in a neighborhood V of zero. If $\det K(\lambda) \not\equiv 0$ in V , then there exist integers $\ell, d_\rho, m_\rho, \rho = 1, \dots, \ell$, with*

$$0 \leq d_1 < \dots < d_\ell \quad \text{and} \quad m_\rho > 0, \quad \rho = 1, \dots, \ell,$$

$n \times n$ -matrices $F(\lambda)$, $G(\lambda)$ and a neighborhood U of zero such that

- (i) $M(\lambda) = F(\lambda)K(\lambda)G(\lambda) = \text{diag}(\lambda^{d_1}M_1(\lambda), \dots, \lambda^{d_\ell}M_\ell(\lambda))$ in U ,
- (ii) $F(\lambda)$, $G(\lambda)$ are holomorphic in U and $\det F(\lambda) \equiv \det G(\lambda) \equiv 1$ in U ,
- (iii) $M_\rho(\lambda)$, $\rho = 1, \dots, \ell$, is an $m_\rho \times m_\rho$ -matrix, which is holomorphic in U with $\det M_\rho(\lambda) \neq 0$ in U ,
- (iv) the numbers ℓ , m_ρ , d_ρ are uniquely determined by properties (i) – (iii).

Proof. The power series expansion of $K(\lambda)$ around 0 has the following form:

$$K(\lambda) = \lambda^{n_1}H(\lambda), \quad H_0 \neq 0, \quad n_1 \geq 0,$$

where $H(\lambda) = \sum_{j=0}^{\infty} \lambda^j H_j$.

Case 1.

Assume that $\det H_0 \neq 0$. In this case we have $F(\lambda) \equiv G(\lambda) \equiv I$, $\ell = 1$, $d_1 = n_1$, $m_1 = n$, because

$$K(\lambda) = \lambda^{n_1}H(\lambda)$$

satisfies already (i)–(iii).

Case 2.

Assume that $\det H_0 = 0$. Let $m_1 = \text{rank } H_0$. From $H_0 \neq 0$ and $\det H_0 = 0$ we see that

$$0 < m_1 < n.$$

Let X, Y be $n \times n$ -matrices with $\det X = \det Y = 1$ such that

$$XH_0Y = \begin{pmatrix} H_{00} & 0 \\ 0 & 0 \end{pmatrix},$$

where H_{00} is an $m_1 \times m_1$ -matrix with $\det H_{00} \neq 0$. Observing $H(\lambda) = H_0 + \lambda \sum_{j=1}^{\infty} \lambda^{j-1} H_j$ we get

$$XH(\lambda)Y = \begin{pmatrix} H_{00} & 0 \\ 0 & 0 \end{pmatrix} + \lambda \begin{pmatrix} H_{11}(\lambda) & H_{12}(\lambda) \\ H_{21}(\lambda) & H_{22}(\lambda) \end{pmatrix},$$

where the $H_{ij}(\lambda)$ are matrices which are holomorphic in V . We set

$$M_1(\lambda) = H_{00} + \lambda H_{11}(\lambda).$$

From $\det H_{00} \neq 0$ we conclude that $\det M_1(\lambda) \neq 0$ in a neighborhood \tilde{U} of 0. Therefore $M_1(\lambda)^{-1}$ exists in \tilde{U} and is holomorphic there. From the equation

$$\begin{pmatrix} I & 0 \\ -\lambda H_{21} M_1^{-1} & I \end{pmatrix} \begin{pmatrix} M_1 & \lambda H_{12} \\ \lambda H_{21} & \lambda H_{22} \end{pmatrix} \begin{pmatrix} I & -\lambda M_1^{-1} H_{12} \\ 0 & I \end{pmatrix} = \begin{pmatrix} M_1 & 0 \\ 0 & \lambda K_2 \end{pmatrix},$$

where $K_2(\lambda) = H_{22}(\lambda) - \lambda H_{21}(\lambda) M_1(\lambda)^{-1} H_{12}(\lambda)$, we see that

$$F_1(\lambda) K(\lambda) G_1(\lambda) = \begin{pmatrix} \lambda^{n_1} M_1(\lambda) & 0 \\ 0 & \lambda^{n_1+1} K_2(\lambda) \end{pmatrix},$$

where $\det F_1(\lambda) \equiv \det G_1(\lambda) \equiv 1$ in \tilde{U} . The matrix $K_2(\lambda)$ is holomorphic in \tilde{U} and has a power series expansion

$$K_2(\lambda) = \lambda^{n_2} \sum_{j=0}^{\infty} \lambda^j H_j^{(2)} \quad \text{with } H_0^{(2)} \neq 0.$$

If $\det H_0^{(2)} \neq 0$, then we have

$$d_1 = n_1, \quad d_2 = n_1 + n_2 + 1 > d_1, \quad m_2 = n - m_1, \quad \ell = 2$$

and $M_2(\lambda) = K_2(\lambda)$.

If $\det H_0^{(2)} = 0$, we set $m_2 = \text{rank } H_0^{(2)}$ and proceed as above in Case 2. In a finite number of steps we arrive at $M(\lambda)$ as given in the theorem.

It remains to prove (iv). In order to do this we have to introduce the notion of determinantal divisors for a holomorphic matrix. ■

For an $n \times n$ -matrix $N(\lambda)$ which is holomorphic in a neighborhood U of zero we introduce the numbers $\beta_\nu(N)$, $\nu = 1, \dots, n$, as follows:

- (i) Any $\nu \times \nu$ -minor of $N(\lambda)$ has the form

$$\lambda^{\beta_\nu(N)} q(\lambda), \quad \lambda \in U,$$

where $q(\lambda)$ is holomorphic in U .

- (ii) There exists at least one $\nu \times \nu$ -minor of $N(\lambda)$ such that $q(0) \neq 0$.

Since a $(\nu + 1) \times (\nu + 1)$ -minor is a linear combination of $\nu \times \nu$ -minors (Laplace expansion theorem for determinants), we have

$$\beta_{\nu+1}(N) \geq \beta_\nu(N), \quad \nu = 1, \dots, n - 1.$$

The following lemma shows that equivalence transformations of the form appearing in Theorem 2.4 leave the numbers β_ν invariant.

Lemma 2.5 *Let $K(\lambda)$ be an $n \times n$ -matrix being holomorphic in a neighborhood U of 0. Let $M(\lambda) = F(\lambda)K(\lambda)G(\lambda)$, $\lambda \in U$, where $F(\lambda)$ and $G(\lambda)$ satisfy (ii) of Theorem 2.4. Then we have*

$$\beta_\nu(M) = \beta_\nu(K), \quad \nu = 1, \dots, n.$$

Proof. If $K \begin{pmatrix} j_1, \dots, j_\nu \\ k_1, \dots, k_\nu \end{pmatrix}$ denotes the $\nu \times \nu$ -minor containing the elements in rows j_1, \dots, j_ν and columns k_1, \dots, k_ν of $K(\lambda)$, then the Binét-Cauchy formula gives (see for instance [8])

$$M \begin{pmatrix} j_1, \dots, j_\nu \\ k_1, \dots, k_\nu \end{pmatrix} = \sum_{\substack{1 \leq \alpha_1 < \dots < \alpha_\nu \leq n \\ 1 \leq \sigma_1 < \dots < \sigma_\nu \leq n}} F \begin{pmatrix} j_1, \dots, j_\nu \\ \alpha_1, \dots, \alpha_\nu \end{pmatrix} K \begin{pmatrix} \alpha_1, \dots, \alpha_\nu \\ \sigma_1, \dots, \sigma_\nu \end{pmatrix} G \begin{pmatrix} \sigma_1, \dots, \sigma_\nu \\ k_1, \dots, k_\nu \end{pmatrix}.$$

This shows that

$$M \begin{pmatrix} j_1, \dots, j_\nu \\ k_1, \dots, k_\nu \end{pmatrix} = \lambda^{\beta_\nu(K)} p(\lambda),$$

where $p(\lambda)$ is holomorphic at zero. Consequently we have

$$\beta_\nu(M) \geq \beta_\nu(K).$$

Starting from $K(\lambda) = F(\lambda)^{-1}M(\lambda)G(\lambda)^{-1}$ we get

$$\beta_\nu(K) \geq \beta_\nu(M).$$

■

Proof for (iv) of Theorem 2.4. From Lemma 2.5 we conclude that

$$\beta_\nu := \beta_\nu(K) = \beta_\nu(M), \quad \nu = 1, \dots, n.$$

Using the special form of $M(\lambda)$,

$$M(\lambda) = \begin{pmatrix} \lambda^{d_1} M_1(\lambda) & & & & \\ & \lambda^{d_2} M_2(\lambda) & & & 0 \\ & & & \ddots & \\ 0 & & & & \lambda^{d_\ell} M_\ell(\lambda) \end{pmatrix},$$

we see that (observe $\det M_j(0) \neq 0$, $j = 1, \dots, \ell$)

$$\beta_1 = d_1, \beta_2 = 2d_1, \dots, \beta_{m_1} = m_1 d_1,$$

$$\beta_{m_1+1} = m_1 d_1 + d_2, \dots, \beta_{m_1+m_2} = m_1 d_1 + m_2 d_2,$$

⋮

$$\begin{aligned} \beta_{m_{\ell-1}+1} &= \sum_{\rho=1}^{\ell-1} m_\rho d_\rho + d_\ell, \dots, \beta_{n-1} = \sum_{\rho=1}^{\ell-1} m_\rho d_\rho + (m_\ell - 1)d_\ell, \beta_n \\ &= \sum_{\rho=1}^{\ell} m_\rho d_\rho. \end{aligned}$$

From this we also see that (using $d_1 < d_2 < \dots < d_\ell$)

$$\beta_{k+1} - \beta_k \geq \beta_k - \beta_{k-1}, \quad k = 1, \dots, n-1,$$

where the “>”-sign is valid exactly for

$$k = m_1, m_2, \dots, m_{\ell-1}.$$

From this it is clear that the numbers m_ρ , d_ρ are uniquely determined by the numbers β_1, \dots, β_n . Indeed, we have to proceed as follows:

Step 1.

Given β_1, \dots, β_n , compute the sequence

$$\beta_2 - \beta_1 \leq \beta_3 - \beta_2 \leq \dots \leq \beta_n - \beta_{n-1}.$$

The numbers $m_1, \dots, m_{\ell-1}$ are those indices, where a strict inequality occurs in this sequence,

$$\beta_{m_\rho+1} - \beta_{m_\rho} > \beta_{m_\rho} - \beta_{m_\rho-1}, \quad \rho = 1, \dots, \ell-1$$

(the number of strict inequalities in the above sequence is $\ell-1$). The number m_ℓ is given by $n - \sum_{\rho=1}^{\ell-1} m_\rho$.

Step 2.

The numbers d_ρ are given by ($m_0 := 0$)

$$\begin{aligned} d_\rho &= \beta_k - \beta_{k-1}, & k &= m_{\rho-1} + 1, \dots, m_\rho, & \rho &= 1, \dots, \ell-1, \\ d_\ell &= \beta_k - \beta_{k-1}, & k &= m_{\ell-1} + 1, \dots, n. \end{aligned}$$

Since the numbers ℓ , d_ρ , m_ρ , $\rho = 1, \dots, \ell$, are uniquely determined by β_1, \dots, β_n , which in turn are uniquely determined by the equivalence class of $K(\lambda)$ (with respect to equivalence transforms satisfying (ii) of Theorem 2.4), we have proved (iv). ■

Remark. The polynomials $\delta_\nu(\lambda) := \lambda^{\beta_\nu}$, $\nu = 1, \dots, n$, are called the **determinantal divisors** of $K(\lambda)$ at $\lambda = 0$, whereas the polynomials

$$\varepsilon_1(\lambda) \equiv 1, \quad \varepsilon_\nu(\lambda) = \lambda^{\beta_\nu - \beta_{\nu-1}}, \quad \nu = 2, \dots, n,$$

are the **elementary divisors** of $K(\lambda)$ at $\lambda = 0$. From the relations between the numbers β_ν we conclude that

$$\delta_\nu \mid \delta_{\nu+1} \quad \text{and} \quad \varepsilon_\nu \mid \varepsilon_{\nu+1}, \quad \nu = 1, \dots, n-1.$$

The following lemma relates the matrices

$$\tilde{B}_k(\lambda_0) = \begin{pmatrix} B_{-\mu} & B_{-\mu+1} & \cdots & B_{-\mu+k-1} \\ 0 & \ddots & \ddots & \vdots \\ \vdots & \ddots & \ddots & B_{-\mu+1} \\ 0 & \cdots & 0 & B_{-\mu} \end{pmatrix} \in \mathbb{C}^{nk \times nk}, \quad (2.3)$$

$k = 1, 2, \dots$, and the Laurent series of the matrix $B(\lambda)$ around λ_0 ,

$$B(\lambda) = \sum_{j=-\mu}^{\infty} (\lambda - \lambda_0)^j B_j.$$

Lemma 2.6 *Let $F(\lambda)$, $G(\lambda)$ and $H(\lambda)$ be $n \times n$ -matrices with Laurent series*

$$F(\lambda) = \sum_{j=-\mu}^{\infty} (\lambda - \lambda_0)^j F_j, \quad G(\lambda) = \sum_{j=-\nu}^{\infty} (\lambda - \lambda_0)^j G_j$$

$$H(\lambda) = \sum_{j=-\mu-\nu}^{\infty} (\lambda - \lambda_0)^j H_j$$

around $\lambda = \lambda_0$. Then the following two statements are equivalent:

- (i) $H(\lambda) = F(\lambda)G(\lambda)$ in a neighborhood U of λ_0 .
- (ii) $\tilde{H}_k(\lambda_0) = \tilde{F}_k(\lambda_0)\tilde{G}_k(\lambda_0)$ for all $k = 1, 2, \dots$.

Proof. The proof is obvious if we compute the Laurent series expansions on both sides of $H(\lambda) = F(\lambda)G(\lambda)$ around λ_0 . One also has to observe that the coefficient matrix of $\lambda^{-\mu+j-1}$ is the block appearing in the j -th diagonal of $\tilde{F}_k(\lambda_0)$ etc. ■

For the proof of Theorem 2.4 we only need Lemma 2.6 for $\mu = \nu = 0$. Note that in this case

$$\det \tilde{F}_k(\lambda_0) = (\det F(\lambda_0))^k \quad \text{etc.}$$

The general form of Lemma 2.6 will be needed below.

We now compute $\text{rank } \tilde{B}_k(\lambda_0)$ in several steps. Let $M(\lambda)$ be the matrix obtained from $B(\lambda)$ according to Theorem 2.4 (with λ replaced by $\lambda - \lambda_0$ of course). Then according to Lemma 2.6 we have

$$\text{rank } \tilde{B}_k(\lambda_0) = \text{rank } \tilde{M}_k(\lambda_0), \quad k = 1, 2, \dots,$$

where

$$\tilde{M}_k(\lambda_0) = \begin{pmatrix} M(\lambda_0) & \frac{1}{1!}M'(\lambda_0) & \cdots & \cdots & \frac{1}{(k-1)!}M^{(k-1)}(\lambda_0) \\ 0 & \ddots & \ddots & & \vdots \\ \vdots & \ddots & \ddots & \ddots & \vdots \\ \vdots & & \ddots & \ddots & \frac{1}{1!}M'(\lambda_0) \\ 0 & \cdots & \cdots & 0 & M(\lambda_0) \end{pmatrix} \in \mathbb{C}^{nk \times nk}.$$

If we introduce the matrices

$$R_k = \begin{pmatrix} 0 & 1 & 0 & \cdots & 0 \\ \vdots & \ddots & \ddots & \ddots & \vdots \\ \vdots & & \ddots & \ddots & 0 \\ \vdots & & & \ddots & 1 \\ 0 & \cdots & \cdots & \cdots & 0 \end{pmatrix} \in \mathbb{C}^{k \times k} \quad \text{for } k = 2, 3, \dots,$$

and $R_1 = (1)$, then we have

$$\tilde{M}_k(\lambda_0) = \sum_{j=0}^{k-1} R_k^j \otimes \frac{1}{j!} M^{(j)}(\lambda_0), \quad k = 1, 2, \dots,$$

where the Kronecker product of two matrices $X = (x_{ij})$, Y is defined by

$$X \otimes Y = (x_{ij}Y).$$

Lemma 2.7

$$\text{rank } \tilde{M}_k(\lambda_0) = \text{rank} \left(\sum_{j=0}^{k-1} \frac{1}{j!} M^{(j)}(\lambda_0) \otimes R_k^j \right), \quad k = 1, 2, \dots .$$

Proof. For any positive integers k, n there exists an $nk \times nk$ permutation matrix P such that for any matrices $S \in \mathbb{C}^{n \times n}$ and $T \in \mathbb{C}^{k \times k}$ we have (see for instance [9, p. 118])

$$P^{-1}(S \otimes T)P = T \otimes S.$$

Since $\det P \neq 0$, the result is established. ■

In order to compute $\text{rank}(\sum_{j=0}^{k-1} \frac{1}{j!} M^{(j)}(\lambda_0) \otimes R_k^j)$ it is useful to introduce the $nk \times nk$ -matrix

$$M(\lambda_0 I + R_k) = (m_{ij}(\lambda_0 I + R_k))_{i,j=1,\dots,n},$$

where $M(\lambda) = (m_{ij}(\lambda))_{i,j=1,\dots,n}$ and $m_{ij}(\lambda_0 I + R_k)$ is defined by the power series expansion of $m_{ij}(\lambda)$ around λ_0 , $m_{ij}(\lambda) = \sum_{\mu=0}^{\infty} \alpha_{\mu}^{(ij)} (\lambda - \lambda_0)^{\mu}$. That means (observe that $R_k^{\mu} = 0$ for $\mu \geq k$)

$$m_{ij}(\lambda_0 I + R_k) = \sum_{\mu=0}^{k-1} \alpha_{\mu}^{(ij)} R_k^{\mu}, \quad i, j = 1, \dots, n.$$

Since we have $\alpha_{\mu}^{(ij)} = \frac{1}{\mu!} m_{ij}^{(\mu)}(\lambda_0)$, we get

$$M(\lambda_0 I + R_k) = \sum_{j=0}^{k-1} \frac{1}{j!} M^{(j)}(\lambda_0) \otimes R_k^j.$$

Observing the special form of $M(\lambda)$ we get

$$M(\lambda_0 I + R_k) = \text{diag}\left((I_{m_1} \otimes R_k^{d_1})M_1(\lambda_0 I + R_k), \dots \right. \\ \left. \dots (I_{m_\ell} \otimes R_k^{d_\ell})M_\ell(\lambda_0 I + R_k)\right).$$

From

$$\begin{aligned} \text{rank } M_\rho(\lambda_0 I + R_k) &= \text{rank}\left(\sum_{j=0}^{k-1} R_k^j \otimes \frac{1}{j!} M_\rho^{(j)}(\lambda_0)\right) \\ &= \text{rank}\begin{pmatrix} M_\rho(\lambda_0) & * & \cdots & * \\ 0 & \ddots & \ddots & \vdots \\ \vdots & \ddots & \ddots & * \\ 0 & \cdots & 0 & M_\rho(\lambda_0) \end{pmatrix} \\ &= k \text{rank } M_\rho(\lambda_0) = km_\rho \end{aligned}$$

we see that

$$\text{rank}(I_{m_\rho} \otimes R_k^{d_\rho})M_\rho(\lambda_0 I + R_k) = \text{rank}(I_{m_\rho} \otimes R_k^{d_\rho}).$$

Thus we have

$$\text{rank } M(\lambda_0 I + R_k) = \sum_{\rho=1}^{\ell} \text{rank}(I_{m_\rho} \otimes R_k^{d_\rho}) = \sum_{\rho=1}^{\ell} m_\rho \text{rank } R_k^{d_\rho}.$$

Obviously we have

$$\text{rank } R_k^{d_\rho} = \begin{cases} 0 & \text{for } d_\rho \geq k, \\ k - d_\rho & \text{for } d_\rho = 1, 2, \dots, k-1. \end{cases}$$

If $d_1 > 0$, then

$$\text{rank } M(\lambda_0 I + R_k) = 0 \quad \text{for } k = 1, 2, \dots, d_1.$$

For $k > d_1$ define $q = \max\{\rho \in \mathbb{N} \mid d_\rho < k\}$. Then we have

$$\text{rank } M(\lambda_0 I + R_k) = \sum_{\rho=1}^q m_\rho (k - d_\rho).$$

Thus we have proved the following theorem.

Theorem 2.8 *Let $B(\lambda)$ be an $n \times n$ -matrix which is holomorphic at λ_0 and let $\ell, d_\rho, m_\rho, \rho = 1, \dots, \ell$, be the numbers uniquely determined by*

$B(\lambda)$ according to Theorem 2.4. Denote by k_0 the multiplicity of λ_0 as a root of $\det B(\lambda)$ and by κ_0 the order of λ_0 as a pole of $B(\lambda)^{-1}$. Then we have

$$\text{rank } \tilde{B}_k(\lambda_0) = \begin{cases} 0 & \text{for } k = 1, \dots, d_1 \text{ (if } d_1 > 0), \\ \sum_{\rho=1}^q m_\rho(k - d_\rho) & \text{for } k = d_q + 1, \dots, d_{q+1}, \\ & q = 1, \dots, \ell - 1, \\ nk - k_0 & \text{for } k \geq d_\ell. \end{cases}$$

Moreover, we have $\kappa_0 = d_\ell$.

Concerning the result for $k \geq d_\ell$ we have to note that

$$\sum_{\rho=1}^{\ell} m_\rho = n \quad \text{and} \quad \sum_{\rho=1}^{\ell} m_\rho d_\rho = k_0.$$

The latter equation follows from the special form of $M(\lambda)$. Furthermore, from

$$M(\lambda)^{-1} = G(\lambda)^{-1} B(\lambda)^{-1} F(\lambda)^{-1}$$

and the fact that $G(\lambda)^{-1}$, $F(\lambda)^{-1}$ are holomorphic at λ_0 we see that $\kappa_0 = d_\ell$.

Corollary 2.9 *We have*

$$\dim \ker \tilde{\Delta}_k(\lambda_0) = \begin{cases} nk & \text{for } k = 1, \dots, d_1, \\ & \text{(if } d_1 > 0), \\ k \sum_{\rho=q+1}^{\ell} m_\rho + \sum_{\rho=1}^q m_\rho d_\rho & \text{for } k = d_q + 1, \dots, d_{q+1}, \\ & q = 1, \dots, \ell - 1, \\ k_0 & \text{for } k = \kappa_0, \kappa_0 + 1, \dots \end{cases}$$

In particular we have

$$\dim P_{\lambda_0} = k_0.$$

Furthermore, κ_0 in the representation (2.2) of P_{λ_0} cannot be replaced by a smaller number.

Proof. The proof is obvious. We only have to observe that

$$\begin{aligned} nk - \sum_{\rho=1}^q m_\rho(k - d_\rho) &= k \sum_{\rho=1}^{\ell} m_\rho - \sum_{\rho=1}^q m_\rho(k - d_\rho) \\ &= k \sum_{\rho=q+1}^{\ell} m_\rho + \sum_{\rho=1}^q m_\rho d_\rho. \end{aligned}$$

For $k = \kappa_0 - 1 = d_\ell - 1$ we get $\dim \ker \tilde{\Delta}_k(\lambda_0) = (d_\ell - 1)m_\ell + \sum_{\rho=1}^{\ell-1} m_\rho d_\rho = \kappa_0 - m_\ell < \kappa_0$, which proves the claim on κ_0 . ■

Remarks. 1. That $\dim P_{\lambda_0} = \kappa_0$ was first proved in [24]. The presentation given here is based on [20]. For the elementary divisor theory for holomorphic matrices see [14].

2. The results presented above are true whenever Proposition 2.1 is true and λ_0 is a zero of finite multiplicity of $\det \Delta(\lambda)$.

The results of this section can also be interpreted for the solution semigroup \mathcal{T} and its infinitesimal generator \mathcal{A} .

Theorem 2.10 *Let $\psi \in \mathcal{C}$ and $\lambda_0 \in \sigma(\mathcal{A})$ be given.*

a) *The following statements are equivalent:*

(i) $\psi \in \text{range}(\mathcal{A} - \lambda_0 I)^k$.

(ii) *The equation*

$$\tilde{\Delta}_k(\lambda_0)\tilde{b}_k = -\tilde{p}_k(\lambda_0; \psi) = -\text{col}(p_{k-1}(\lambda_0; \psi), \dots, p_0(\lambda_0; \psi)) \quad (2.4)$$

has a solution \tilde{b}_k , where

$$p_j(\lambda_0; \psi) = \frac{1}{j!} \frac{d^j}{d\lambda^j} p(\lambda; \psi) \Big|_{\lambda=\lambda_0}.$$

(iii) *There exist vectors $b_0, \dots, b_{k-1} \in \mathbb{C}^n$ such that the function*

$$\phi = \sum_{j=0}^{k-1} e_j(\lambda_0)b_j + e_{k-1}(\lambda_0) * \psi \quad (2.5)$$

is in $\text{dom } \mathcal{A}^k$ (for the definition of e_j see (1.10)).

b) *If $\psi \in \text{range}(\mathcal{A} - \lambda_0 I)^k$, then $\psi = (\mathcal{A} - \lambda_0 I)^k \phi$ for any ϕ which is given by (2.5), where $\tilde{b}_k = \text{col}(b_0, \dots, b_{k-1})$ is a solution of (2.4).*

Proof. An easy calculation shows that for ϕ given by (2.5) we have

$$\dot{\phi} - \lambda_0 \phi = \sum_{j=0}^{k-2} e_j(\lambda_0)b_{j+1} + e_{k-2}(\lambda_0) * \psi \quad (2.6)$$

and

$$L(\phi) = - \sum_{j=0}^{k-1} \frac{1}{j!} \Delta^{(j)}(\lambda_0) b_j + \lambda_0 b_0 + b_1 - p_{k-1}(\lambda_0; \psi).$$

Here we have used

$$\int_{-r}^0 \theta^j e^{\lambda_0 \theta} d\eta(\theta) = \begin{cases} \lambda_0 I - \Delta(\lambda_0) & \text{for } j = 0, \\ I - \Delta'(\lambda_0) & \text{for } j = 1, \\ -\Delta^{(j)}(\lambda_0) & \text{for } j = 2, 3, \dots, \end{cases}$$

and

$$p_{k-1}(\lambda_0; \psi) = - \int_{-r}^0 [d\eta(\theta)] (e_{k-1}(\lambda_0) * \psi)(\theta).$$

From (2.6) we get $\dot{\phi}(0) = \lambda_0 b_0 + b_1$. Therefore we have $\phi \in \text{dom } \mathcal{A}$ if and only if

$$\sum_{j=0}^{k-1} \frac{1}{j!} \Delta^{(j)}(\lambda_0) b_j = -p_{k-1}(\lambda_0; \psi). \quad (2.7)$$

In this case equation (2.6) just means

$$(\mathcal{A} - \lambda_0 I)\phi = \sum_{j=0}^{k-2} e_j(\lambda_0) b_{j+1} + e_{k-2}(\lambda_0) * \psi.$$

Analogously we see that $(\mathcal{A} - \lambda_0 I)\phi \in \text{dom } \mathcal{A}$ if and only if

$$\sum_{j=0}^{k-2} \frac{1}{j!} \Delta^{(j)}(\lambda_0) b_{j+1} = -p_{k-2}(\lambda_0; \psi). \quad (2.8)$$

Therefore ϕ is in $\text{dom } \mathcal{A}^2$ if and only if (2.7) and (2.8) are satisfied. In $k-1$ steps we obtain that ϕ is in $\text{dom } \mathcal{A}^{k-1}$ if and only if

$$\sum_{j=0}^{k-1-i} \frac{1}{j!} \Delta^{(j)}(\lambda_0) b_{j+i} = -p_{k-1-i}(\lambda_0; \psi), \quad i = 0, \dots, k-2. \quad (2.9)$$

Moreover, we have

$$\chi := (\mathcal{A} - \lambda_0 I)^{k-1} \phi = e_0(\lambda_0) b_{k-1} + e_0(\lambda_0) * \psi.$$

For χ we get $\dot{\chi} = \lambda_0 \chi + \psi$, $\dot{\chi}(0) = \lambda_0 b_{k-1} + \psi(0)$ and $L(\chi) = -\Delta(\lambda_0) b_{k-1} + \lambda_0 b_{k-1} - p_0(\lambda_0; \psi) + \psi(0)$. Therefore χ is in $\text{dom } \mathcal{A}$ if and only if $\Delta(\lambda_0) b_{k-1} = -p_0(\lambda_0; \psi)$. This proves $\phi \in \text{dom } \mathcal{A}^k$ if and only if (2.9) holds also for $i = k-1$, i.e., if and only if (2.4) is satisfied. Moreover, we

have $(\mathcal{A} - \lambda_0 I)\chi = (\mathcal{A} - \lambda_0 I)^k \phi$ in this case. Thus we have established that (iii) is equivalent to (ii) and that (iii) implies (i).

Assume that $\psi \in \text{range}(\mathcal{A} - \lambda_0 I)^k$, i.e., $\psi = (\mathcal{A} - \lambda_0 I)^k \phi$ for some $\phi \in \text{dom } \mathcal{A}^k$. Then ϕ is solution of the differential equation

$$\left(\frac{d}{d\theta} - \lambda_0\right)^k \phi = \psi.$$

This implies that ϕ is given by (2.5). Since $\phi \in \text{dom } \mathcal{A}^k$, the vector \tilde{b}_k solves (2.4). This proves that (i) implies (iii). ■

Corollary 2.11 *Let $\phi \in \mathcal{C}$ and $\lambda_0 \in \sigma(\mathcal{A})$ be given. Then we have*

$$\phi \in \ker(\mathcal{A} - \lambda_0 I)^k$$

if and only if

$$\phi = \sum_{j=0}^{k-1} e_j(\lambda_0) b_j \quad \text{with } \tilde{\Delta}_k(\lambda_0) \tilde{b}_k = 0.$$

Proof. The result follows immediately from Theorem 2.10, b), for $\psi = 0$. ■

The proof of Proposition 2.3, b), for general k , shows that $\dim \ker(\mathcal{A} - \lambda_0 I)^k = \dim \ker \tilde{\Delta}_k(\lambda_0)$. Therefore Corollary 2.9 gives also the dimension of $\ker(\mathcal{A} - \lambda_0 I)^k$, $k = 1, 2, \dots$. From Proposition 2.3 we see that

$$P_{\lambda_0} = \ker(\mathcal{A} - \lambda_0 I)^k, \quad k = \kappa_0, \kappa_0 + 1, \dots \quad (2.10)$$

We call a subspace Z of P_{λ_0} **cyclic** with respect to \mathcal{A} , if there exists a basis $\phi_0, \dots, \phi_{k-1}$ of Z ($k = \dim Z$) such that

$$\begin{aligned} \mathcal{A}\phi_0 &= \lambda_0 \phi_0, \\ \mathcal{A}\phi_j &= \lambda_0 \phi_j + \phi_{j-1}, \quad j = 1, \dots, k-1. \end{aligned}$$

From the results given above it is possible to determine the decomposition of P_{λ_0} into a direct sum of subspaces cyclic with respect to \mathcal{A} .

Theorem 2.12 *Let $\lambda_0 \in \sigma(L)$ and let ℓ , d_ρ and m_ρ , $\rho = 1, \dots, \ell$, be the numbers associated with $\Delta(\lambda)$ at λ_0 according to Theorem 2.4. Then*

$$P_{\lambda_0} = \bigoplus_{\rho=1}^{\ell} \bigoplus_{j=1}^{m_\rho} Z_{\rho,j},$$

where $Z_{\rho,j}$, $j = 1, \dots, m_\rho$, is a subspace cyclic with respect to \mathcal{A} with $\dim Z_{\rho,j} = d_\rho$.

Proof. Since $\dim \ker(\mathcal{A} - \lambda_0 I)^{d_\ell} - \dim \ker(\mathcal{A} - \lambda_0 I)^{d_\ell-1} = m_\ell$, we can choose m_ℓ elements $\psi_{j,\ell} \in \ker(\mathcal{A} - \lambda_0 I)^{d_\ell}$, $j = 1, \dots, m_\ell$, such that $\sum_{j=1}^{m_\ell} \alpha_j \psi_{j,\ell} \in \ker(\mathcal{A} - \lambda_0 I)^{d_\ell-1}$ implies $\alpha_1 = \dots = \alpha_{m_\ell} = 0$. We put

$$\phi_{j,i}^{(\ell)} = (\mathcal{A} - \lambda_0 I)^{d_\ell-1-i} \psi_{j,\ell}, \quad i = 0, \dots, d_\ell - 1, \quad j = 1, \dots, m_\ell.$$

For each $j = 1, \dots, m_\ell$, the subspace

$$Z_{\ell,j} = \text{span}(\phi_{j,0}^{(\ell)}, \dots, \phi_{j,d_\ell-1}^{(\ell)})$$

is cyclic. This follows from

$$\begin{aligned} (\mathcal{A} - \lambda_0 I) \phi_{j,0}^{(\ell)} &= (\mathcal{A} - \lambda_0 I)^{d_\ell} \psi_{j,\ell} = 0, \\ (\mathcal{A} - \lambda_0 I) \phi_{j,i}^{(\ell)} &= (\mathcal{A} - \lambda_0 I)^{d_\ell-i} \psi_{j,\ell} = \phi_{j,i-1}^{(\ell)}, \quad i = 1, \dots, d_\ell - 1. \end{aligned}$$

By definition of the $\phi_{j,i}^{(\ell)}$'s we see that $\phi_{j,i}^{(\ell)} \in \ker(\mathcal{A} - \lambda_0 I)^{i+1}$, $j = 1, \dots, m_\ell$. Furthermore, $\sum_{j=1}^{m_\ell} \alpha_j \phi_{j,i}^{(\ell)} \in \ker(\mathcal{A} - \lambda_0 I)^i$ implies $\alpha_1 = \dots = \alpha_{m_\ell} = 0$, $i = 0, \dots, d_\ell - 1$. Indeed, from $0 = \sum_{j=1}^{m_\ell} \alpha_j (\mathcal{A} - \lambda_0 I)^i \phi_{j,i}^{(\ell)} = \sum_{j=1}^{m_\ell} \alpha_j (\mathcal{A} - \lambda_0 I)^{d_\ell-1} \psi_{j,i}$ we see that $\sum_{j=1}^{m_\ell} \alpha_j \psi_{j,i} \in \ker(\mathcal{A} - \lambda_0 I)^{d_\ell-1}$, which by choice of the $\psi_{j,i}$'s implies $\alpha_1 = \dots = \alpha_{m_\ell} = 0$.

In the next step we observe

$$\dim \ker(\mathcal{A} - \lambda_0 I)^{d_\ell-1} - \dim \ker(\mathcal{A} - \lambda_0 I)^{d_\ell-1-1} = m_\ell + m_{\ell-1}$$

and choose $m_{\ell-1}$ elements $\psi_{j,\ell-1} \in \ker(\mathcal{A} - \lambda_0 I)^{d_\ell-1}$, $j = 1, \dots, m_{\ell-1}$, such that

$$\sum_{j=1}^{m_\ell} \alpha_j (\mathcal{A} - \lambda_0 I)^{d_\ell-d_{\ell-1}} \psi_{j,\ell} + \sum_{j=1}^{m_{\ell-1}} \beta_j \psi_{j,\ell-1} \in \ker(\mathcal{A} - \lambda_0 I)_{d_{\ell-1}-1}$$

implies $\alpha_1 = \dots = \alpha_{m_\ell} = \beta_1 = \dots = \beta_{m_{\ell-1}} = 0$. We set

$$\phi_{j,i}^{(\ell-1)} = (\mathcal{A} - \lambda_0 I)^{d_{\ell-1}-1-i} \psi_{j,\ell-1}, \quad i = 0, \dots, d_{\ell-1} - 1, \quad j = 1, \dots, m_{\ell-1}.$$

As in the first step we see that the spaces

$$Z_{\ell-1,j} = \text{span}(\phi_{j,0}^{(\ell-1)}, \dots, \phi_{j,d_{\ell-1}-1}^{(\ell-1)}), \quad j = 1, \dots, m_{\ell-1},$$

are cyclic. Furthermore, we have $\phi_{j,i}^{(\ell-1)} \in \ker(\mathcal{A} - \lambda_0 I)^{i+1}$ for $j = 1, \dots, m_{\ell-1}$, $i = 0, \dots, d_{\ell-1} - 1$ and

$$\sum_{j=1}^{m_\ell} \alpha_j \phi_{j,i}^{(\ell)} + \sum_{j=1}^{m_{\ell-1}} \beta_j \phi_{j,i}^{(\ell-1)} \in \ker(\mathcal{A} - \lambda_0 I)^i$$

implies $\alpha_1 = \dots = \alpha_{m_\ell} = \beta_1 = \dots = \beta_{m_{\ell-1}} = 0$. This follows from

$$\begin{aligned} 0 &= \sum_{j=1}^{m_\ell} \alpha_j (\mathcal{A} - \lambda_0 I)^i \phi_{j,i}^{(\ell)} + \sum_{j=1}^{m_{\ell-1}} \beta_j (\mathcal{A} - \lambda_0 I)^i \phi_{j,i}^{(\ell-1)} \\ &= \sum_{j=1}^{m_\ell} \alpha_j (\mathcal{A} - \lambda_0 I)^{d_\ell-1} \psi_{j,\ell} + \sum_{j=1}^{m_{\ell-1}} \beta_j (\mathcal{A} - \lambda_0 I)^{d_{\ell-1}-1} \psi_{j,\ell-1}, \end{aligned}$$

which means

$$\sum_{j=1}^{m_\ell} \alpha_j (\mathcal{A} - \lambda_0 I)^{d_\ell-d_{\ell-1}} \psi_{j,\ell} + \sum_{j=1}^{m_{\ell-1}} \beta_j \psi_{j,\ell-1} \in \ker(\mathcal{A} - \lambda_0 I)^{d_{\ell-1}-1}.$$

In a finite number of steps we obtain the cyclic subspaces

$$Z_{\rho,j} = \text{span}(\phi_{j,0}^{(\rho)}, \dots, \phi_{j,d_\rho-1}^{(\rho)}), \quad \rho = 1, \dots, \ell, \quad j = 1, \dots, m_\rho.$$

The $\sum_{\rho=1}^{\ell} m_\rho d_\rho = k_0 = \dim P_{\lambda_0}$ elements

$$\begin{aligned} &\phi_{j,i}^{(\ell)}, \quad j = 1, \dots, m_\ell, \quad i = 0, \dots, d_\ell - 1, \\ &\phi_{j,i}^{(\ell-1)}, \quad j = 1, \dots, m_{\ell-1}, \quad i = 0, \dots, d_{\ell-1} - 1, \\ &\vdots \\ &\phi_{j,i}^{(1)}, \quad j = 1, \dots, m_1, \quad i = 0, \dots, d_1 - 1, \end{aligned}$$

are linearly independent. This can be seen as follows. Assume that

$$\sum_{\rho=1}^{\ell} \sum_{j=1}^{m_\rho} \sum_{i=0}^{d_\rho-1} \alpha_{j,i}^{(\rho)} \phi_{j,i}^{(\rho)} = 0. \quad (2.11)$$

This implies $\sum_{j=1}^{m_\ell} \alpha_{j,d_\ell-1}^{(\ell)} \phi_{j,d_\ell-1}^{(\ell)} \in \ker(\mathcal{A} - \lambda_0 I)^{d_\ell-1}$ and thus $\alpha_{j,d_\ell-1}^{(\ell)} = 0$, $j = 1, \dots, m_\ell$. Then (2.11) implies

$$\sum_{j=1}^{m_\ell} \alpha_{j,d_\ell-2}^{(\ell)} \phi_{j,d_\ell-2}^{(\ell)} \in \ker(\mathcal{A} - \lambda_0 I)^{d_\ell-2}$$

or (observe $\phi_{j,d_\ell-2}^{(\ell)} = (\mathcal{A} - \lambda_0 I)\psi_{j,\ell}$)

$$\sum_{j=1}^{m_\ell} \alpha_{j,d_\ell-2}^{(\ell)} \psi_{j,\ell} \in \ker(\mathcal{A} - \lambda_0 I)^{d_\ell-1}.$$

Consequently we have $\alpha_{j,d_{\ell-2}}^{(\ell)} = 0$, $j = 1, \dots, m_{\ell}$. Analogously we see that $\alpha_{j,i}^{(\ell)} = 0$, $j = 1, \dots, m_{\ell}$, $i = d_{\ell-1}, \dots, d_{\ell} - 3$. Then (2.11) implies that

$$\begin{aligned} & \sum_{j=1}^{m_{\ell}} \alpha_{j,d_{\ell-1}-1}^{(\ell)} \phi_{j,d_{\ell-1}-1}^{(\ell)} + \sum_{j=1}^{m_{\ell-1}} \alpha_{j,d_{\ell-1}-1}^{(\ell-1)} \phi_{j,d_{\ell-1}-1}^{(\ell-1)} \\ &= \sum_{j=1}^{m_{\ell}} \alpha_{j,d_{\ell-1}-1}^{(\ell)} (\mathcal{A} - \lambda_0 I)^{d_{\ell}-d_{\ell-1}} \psi_{j,\ell} \\ & \quad + \sum_{j=1}^{m_{\ell-1}} \alpha_{j,d_{\ell-1}-1}^{(\ell-1)} \psi_{j,\ell-1} \in \ker(\mathcal{A} - \lambda_0 I)^{d_{\ell-1}-1} \end{aligned}$$

and consequently $\alpha_{j,d_{\ell-1}-1}^{(\ell)} = 0$, $j = 1, \dots, m_{\ell}$, and $\alpha_{j,d_{\ell-1}-1}^{(\ell-1)} = 0$, $j = 1, \dots, m_{\ell-1}$.

Continuing in this way we see that $\alpha_{j,i}^{(\rho)} = 0$ for $\rho = 1, \dots, \ell$, $j = 1, \dots, m_{\rho}$, $i = 0, \dots, d_{\rho} - 1$, which proves that the elements $\phi_{j,i}^{(\rho)}$, $\rho = 1, \dots, \ell$, $j = 1, \dots, m_{\rho}$, $i = 0, \dots, d_{\rho} - 1$, are a basis for P_{λ_0} . It also proves that $\dim Z_{\rho,j} = d_{\rho}$. ■

Of special interest are the extreme cases, i.e., all cyclic subspaces of P_{λ_0} are of dimension one resp. P_{λ_0} itself is cyclic.

Proposition 2.13 *Let k_0 be the multiplicity of λ_0 as a root of $\det \Delta(\lambda)$.*

a) *The following statements are equivalent:*

- (1) *All subspaces cyclic with respect to \mathcal{A} of P_{λ_0} are one-dimensional.*
- (2) *One of the following two conditions is satisfied:*
 - (i) $k_0 < n$ and $\text{rank } \Delta'(\lambda_0) = n - k_0$.
 - (ii) $k_0 = n$, $\Delta(\lambda_0) = 0$ and $\text{rank } \Delta'(\lambda_0) = n$.

- (3) $\kappa_0 = 1$ (κ_0 is the order of the pole of $\Delta^{-1}(\lambda)$ at λ_0).

b) *The following statements are equivalent:*

- (1) P_{λ_0} is cyclic with respect to \mathcal{A} .
- (2) We have

$$\text{rank } \Delta(\lambda_0) = n - 1. \tag{2.12}$$

- (3) $\kappa_0 = k_0$.

Proof. a) All cyclic subspaces to be of dimension 1 is equivalent to $d_\rho \leq 1$ for all $\rho = 1, \dots, \ell$. In view of $0 \leq d_1 < d_2 < \dots < d_\ell$ this is equivalent to either

$$(i') \quad \ell = 2 \quad \text{and} \quad d_1 = 0, \quad d_2 = 1,$$

or

$$(ii') \quad \ell = 1 \quad \text{and} \quad d_1 = 1.$$

In case of (i') the matrix $M(\lambda)$ in Theorem 2.4 is given by $M(\lambda) = \text{diag}(M_1(\lambda), (\lambda - \lambda_0)M_2(\lambda))$. From $m_1 d_1 + m_2 d_2 = k_0$ and $m_1 + m_2 = n$ we immediately get $m_2 = k_0$ and $m_1 = n - k_0$. Therefore condition (i') implies condition (i), because $k_0 < n$ and $\text{rank } \Delta(\lambda_0) = \text{rank } M(\lambda_0) = m_1 = n - k_0$ in this case.

If on the other hand (i) is true, then the numbers β_k defined in the proof of Theorem 2.4 are given by

$$\beta_1 = \dots = \beta_{k_0} = 0, \quad \beta_{k_0+1} \geq 1 \quad \text{and} \quad \beta_n = k_0.$$

This shows $m_1 = k_0$ and $d_1 = 0$. Since $\beta_{m_1} < \dots < \beta_n$ (observe $0 \leq d_1 < d_2 < \dots < d_\ell$), we must have

$$\beta_{n-k_0+i} = i, \quad i = 1, \dots, n.$$

This implies $\ell = 2$, $m_2 = n - k_0$ and $d_2 = 1$, i.e., (i') holds.

In case of (ii') the matrix $M(\lambda)$ is given by $M(\lambda) = (\lambda - \lambda_0)M_1(\lambda)$ which shows that $k_0 = n$, $M(\lambda_0) = 0$ and $\text{rank } M_1(\lambda_0) = n$. From $M(\lambda_0) = F(\lambda_0)\Delta(\lambda_0)G(\lambda_0)$ we get that also $\Delta(\lambda_0) = 0$. But then we have $\Delta(\lambda) = (\lambda - \lambda_0)\Delta_1(\lambda)$. Observing $\Delta_1(\lambda_0) = \Delta'(\lambda_0)$ and $M_1(\lambda_0) = F(\lambda_0)\Delta'(\lambda_0)G(\lambda_0)$ we see that $\text{rank } \Delta'(\lambda_0) = n$. Thus we have shown that (ii') implies (ii).

If on the other hand (ii) is true, then $\beta_n = n$ because of $\text{rank } \Delta'(\lambda_0) = n$ and $d_1 > 0$ because of $\Delta(\lambda_0) = 0$. In this case we have $\beta_1 < \dots < \beta_n$, which together with $\beta_n = n$ implies

$$\beta_i = i, \quad i = 1, \dots, n.$$

This shows $\ell = 1$ and $d_1 = 1$, i.e., (ii') holds.

Since $\kappa_0 = d_\ell$ (see Theorem 2.8), conditions (i') or (ii') imply $\kappa_0 = 1$. If on the other hand $\kappa_0 = 1$, then $d_\ell = 1$, which implies either $\ell = 1$, $d_1 = 1$, i.e., (ii'), or $\ell = 2$, $d_1 = 0$ and $d_2 = 1$, i.e., (i').

b) P_{λ_0} is cyclic if and only if

$$m_\ell = 1 \quad \text{and} \quad d_\ell = k_0 (= \dim P_{\lambda_0}). \quad (2.13)$$

This implies $\sum_{\rho=1}^{\ell-1} m_\rho d_\rho = 0$ which is equivalent to either $\ell = 1$ or $\ell = 2$ and $d_1 = 0$. In the first case we have $n = m_1 = 1$, i.e., $\Delta(\lambda)$ is scalar with $\Delta(\lambda_0) = 0$. In the second case we get $m_1 = n - m_2 = n - 1$. In both cases we have $\text{rank } M(\lambda_0) = \text{rank } \Delta(\lambda_0) = n - 1$.

Suppose conversely that $\text{rank } \Delta(\lambda_0) = n - 1$. For $n = 1$ this means $\beta_1 = \beta_n > 0$ and consequently $\ell = 1$, $m_1 = 1$ and $d_1 = k_0$ (observe $k_0 = m_1 d_1$ in this case). For $n > 1$ we get

$$\beta_1 = \dots = \beta_{n-1} = 0 \quad \text{and} \quad \beta_n = k_0.$$

This implies $\ell = 2$, $m_1 = n - 1$, $d_1 = 0$, $m_2 = 1$ and $d_2 = k_0$.

If (2.13) holds, then $\kappa_0 = d_\ell = k_0$. If conversely $\kappa_0 = k_0$, then $d_\ell = k_0$.

This and $\sum_{\rho=1}^{\ell} m_\rho d_\rho = k_0$ imply $m_\ell = 1$, i.e., (2.13) holds. ■

As a special case we want to consider an n -th order equation

$$y^{(n)}(t) = \sum_{j=0}^{n-1} \int_{-r}^0 y^{(j)}(t + \theta) d\eta_{j+1}(\theta), \quad t \geq 0. \quad (2.14)$$

Such an equation can always be written as a system. We just define

$$x(t) = \text{col}(y(t), \dot{y}(t), \dots, y^{(n-1)}(t)), \quad t \geq -r,$$

and the matrix $\eta(\theta)$ by

$$\eta(\theta) = \begin{pmatrix} 0 & \eta_{12}(\theta) & 0 & \dots & 0 \\ \vdots & \ddots & \ddots & \ddots & \vdots \\ \vdots & & \ddots & \ddots & 0 \\ 0 & \dots & \dots & 0 & \eta_{n-1,n}(\theta) \\ \eta_1(\theta) & \dots & \dots & \dots & \eta_n(\theta) \end{pmatrix},$$

where $\eta_{j,j+1}(\theta) = 0$ for $\theta < 0$ and $= 1$ for $\theta \geq 0$, $j = 1, \dots, n - 1$. If $x(t)$ is a solution of system (1.1) with $\eta(\theta)$ as given above such that $\phi = \text{col}(\phi_1, \dots, \phi_n)$ satisfies $\phi_{i+1} = \dot{\phi}_i$, $i = 1, \dots, n - 1$, then the first coordinate $y(t) = x_1(t)$ is a solution of equation (2.14) with initial data $y(\theta) = \phi_1(\theta), \dots, y^{(n-1)}(\theta) = \phi_n(\theta)$, $-r \leq \theta \leq 0$, and vice versa.

From

$$\Delta(\lambda) = \begin{pmatrix} \lambda & -1 & 0 & \dots & 0 \\ 0 & \ddots & \ddots & \ddots & \vdots \\ \vdots & \ddots & \ddots & \ddots & 0 \\ 0 & \dots & 0 & \lambda & -1 \\ -c_0(\lambda) & \dots & \dots & \dots & -c_{n-1}(\lambda) \end{pmatrix},$$

where

$$c_j(\lambda) = \int_{-r}^0 e^{\lambda\theta} d\eta_{j+1}(\theta), \quad j = 0, \dots, n-1,$$

one sees immediately that

$$\det \Delta(\lambda) = \lambda^n - \sum_{j=0}^{n-1} \lambda^j c_j(\lambda). \quad (2.15)$$

Proposition 2.14 *If λ_0 is a root of multiplicity k_0 of $\det \Delta(\lambda)$ as given in (2.15) then equation (2.14) has at least one solution*

$$y(t) = p(t)e^{\lambda_0 t}, \quad t \in \mathbb{R},$$

where $p(t)$ is a polynomial of degree $k_0 - 1$.

Proof. Obviously we have $\text{rank } \Delta(\lambda_0) = n - 1$ for any zero λ_0 of $\det \Delta(\lambda)$. According to Proposition 2.13, b) we have $\kappa_0 = k_0$. Therefore the equation $\tilde{\Delta}_{k_0}(\lambda_0)\tilde{b}_{k_0} = 0$ has a solution $\tilde{b}_{k_0} = \text{col}(b_0, \dots, b_{k_0-1})$ with $b_{k_0-1} \neq 0$. Indeed, if $b_{k_0-1} = 0$ for all solutions of this equation, then all solutions of this equation satisfy $\tilde{\Delta}_k(\lambda_0)\tilde{b}_k = 0$ for some $k < k_0$, i.e., $P_{\lambda_0} = \ker(\mathcal{A} - \lambda_0 I)^k$ for some $k < k_0 = \kappa_0$, a contradiction to (2.10). The vector $b_{k_0-1} \neq 0$ satisfies $\Delta(\lambda_0)b_{k_0-1} = 0$. The special form of the matrix $\Delta(\lambda_0)$ implies that the first component of b_{k_0-1} is nonzero (otherwise we would have $b_{k_0-1} = 0$). Thus we have shown that the first component $x_1(t)$ of $x(t) = e^{\lambda_0 t} \sum_{j=0}^{k_0-1} \frac{t^j}{j!} b_j$ is of the form

$$x_1(t) = e^{\lambda_0 t} \left(\gamma \frac{t^{k_0-1}}{(k_0-1)!} + q(t) \right), \quad t \geq 0,$$

where $\gamma \neq 0$ and $q(t)$ is a polynomial of degree $\leq k_0 - 2$. Since $y(t) = x_1(t)$ solves (2.14), the proof is finished. ■

2.2 Projections onto eigenspaces

In this sections we shall define continuous projections $\pi_{\lambda_0} : \mathcal{C} \rightarrow P_{\lambda_0}$, $\lambda_0 \in \sigma(L)$, such that $\mathcal{C} = \text{range } \pi_{\lambda_0} \oplus \ker \pi_{\lambda_0}$ is a decomposition of \mathcal{C} , where the subspaces are invariant with respect to equation (1.1) (resp. the solution semigroup \mathcal{T}). The following result will give the motivation for the definition of π_{λ_0} .

Proposition 2.15 *Let $\lambda_0 \in \sigma(L)$ be given and assume that the function $g(\lambda)$ is holomorphic at λ_0 . Then the function*

$$x(t) = \text{Res}_{\lambda=\lambda_0} e^{\lambda t} \Delta^{-1}(\lambda)g(\lambda), \quad t \geq -r,$$

is an generalized eigenfunction of (1.1) corresponding to λ_0 and the function

$$\theta \rightarrow \operatorname{Res}_{\lambda=\lambda_0} e^{\lambda\theta} \Delta^{-1}(\lambda)g(\lambda), \quad -r \leq \theta \leq 0,$$

is in P_{λ_0} .

Proof. As usual let κ_0 denote the order of the pole of $\Delta^{-1}(\lambda)$ at λ_0 . Then the function $e^{\lambda t} \Delta^{-1}(\lambda)g(\lambda)$ has at most a pole of order $\leq \kappa_0$ at λ_0 . From the expansions

$$\Delta^{-1}(\lambda) = \sum_{j=-\kappa_0}^{\infty} (\lambda - \lambda_0)^j D_j \quad \text{and} \quad g(\lambda) = \sum_{j=0}^{\infty} (\lambda - \lambda_0)^j g_j$$

we get

$$\operatorname{Res}_{\lambda=\lambda_0} e^{\lambda t} \Delta^{-1}(\lambda)g(\lambda) = e^{\lambda_0 t} \sum_{j=0}^{\kappa_0-1} \frac{t^j}{j!} c_j, \quad t \geq -r,$$

where

$$c_j = D_{-j-1}g_0 + \cdots + D_{-\kappa_0}g_{\kappa_0-j-1}, \quad j = 0, \dots, \kappa_0 - 1.$$

This can be written as

$$\tilde{c}_{\kappa_0} = \tilde{D}_{\kappa_0} \tilde{g}_{\kappa_0}, \quad (2.16)$$

where $\tilde{c}_{\kappa_0} = \operatorname{col}(c_0, \dots, c_{\kappa_0-1}) \in \mathbb{C}^{n\kappa_0}$, $\tilde{g}_{\kappa_0} = \operatorname{col}(g_{\kappa_0-1}, \dots, g_0) \in \mathbb{C}^{n\kappa_0}$ and

$$\tilde{D}_{\kappa_0} = \begin{pmatrix} D_{-\kappa_0} & D_{-\kappa_0+1} & \cdots & D_1 \\ 0 & \ddots & \ddots & \vdots \\ \vdots & \ddots & \ddots & D_{-\kappa_0+1} \\ 0 & \cdots & 0 & D_{-\kappa_0} \end{pmatrix} \in \mathbb{C}^{n\kappa_0 \times n\kappa_0}. \quad (2.17)$$

Since we have $\Delta(\lambda)\Delta^{-1}(\lambda) \equiv I$ in a neighborhood of λ_0 , we get from Lemma 2.6 (observe that the matrices appearing in the main and the upper diagonals of $\tilde{\Delta}_{\kappa_0} \tilde{D}_{\kappa_0}$ are the coefficient matrices of $\lambda^{-\kappa_0}, \dots, \lambda^{-1}$ in the series expansion $\Delta(\lambda)\Delta^{-1}(\lambda) \equiv I$ around λ_0 which are all zero, of course)

$$\tilde{\Delta}_{\kappa_0} \tilde{D}_{\kappa_0} = 0. \quad (2.18)$$

This together with (2.16) implies

$$\tilde{\Delta}_{\kappa_0} \tilde{c}_{\kappa_0} = 0,$$

which in view of Proposition 2.1 proves the result. \blacksquare

If we take $g(\lambda) = p(\lambda; \phi)$, then $\Delta^{-1}(\lambda)p(\lambda; \phi)$ is the Laplace-transform of $x(t; \phi)$ (see Theorem 1.4, b)). We define $\pi_{\lambda_0} : \mathcal{C} \rightarrow P_{\lambda_0}$ by

$$\pi_{\lambda_0} \phi = \operatorname{Res}_{\lambda=\lambda_0} e_0(\lambda) \Delta^{-1}(\lambda) p(\lambda; \phi), \quad \phi \in \mathcal{C}.$$

This can also be written as

$$\pi_{\lambda_0} \phi = \frac{1}{2\pi i} \int_{\Gamma} e_0(\lambda) \Delta^{-1}(\lambda) p(\lambda; \phi) d\lambda, \quad (2.19)$$

where Γ is any positively oriented circle around λ_0 such that there is no other element of $\sigma(L)$ on Γ or in its interior.

Lemma 2.16 *Let $\lambda_0 \in \sigma(L)$ and $\phi \in \mathcal{C}$ be given. Then we have*

$$(\pi_{\lambda_0} x_t(\phi))(\theta) = \operatorname{Res}_{\lambda=\lambda_0} e^{\lambda(t+\theta)} \Delta^{-1}(\lambda) p(\lambda; \phi), \quad -r \leq \theta \leq 0, \quad t \geq 0.$$

Proof. Fix $t \geq 0$ and define $y(s) = x(s; x_t(\phi)) = x(t+s; \phi)$, $s \geq 0$. According to the definition of π_{λ_0} we have

$$(\pi_{\lambda_0} x_t(\phi))(\theta) = \operatorname{Res}_{\lambda=\lambda_0} e^{\lambda\theta} \Delta^{-1}(\lambda) p(\lambda; x_t(\phi)), \quad -r \leq \theta \leq 0.$$

A short calculation yields

$$\begin{aligned} \hat{y}(\lambda) &= \Delta^{-1}(\lambda) p(\lambda; x_t(\phi)) = \int_0^{\infty} e^{-\lambda\tau} x(t+\tau; \phi) d\tau \\ &= e^{\lambda t} \hat{x}(\lambda; \phi) - e^{\lambda t} \int_0^t e^{-\lambda\tau} x(\tau; \phi) d\tau. \end{aligned}$$

The second term on the right-hand side of this equation is an entire function. Therefore we have (observe that $\hat{x}(t; \phi) = \Delta^{-1}(\lambda) p(\lambda; \phi)$)

$$\operatorname{Res}_{\lambda=\lambda_0} e^{\lambda\theta} \Delta^{-1}(\lambda) p(\lambda; x_t(\phi)) = \operatorname{Res}_{\lambda=\lambda_0} e^{\lambda(t+\theta)} \Delta^{-1}(\lambda) p(\lambda; \phi), \quad -r \leq \theta \leq 0.$$

■

For $\lambda_0 \in \sigma(L)$, define the subspace Q_{λ_0} by

$$Q_{\lambda_0} = \ker \pi_{\lambda_0}.$$

Theorem 2.17 *Let $\lambda_0 \in \sigma(L)$ be given.*

a) π_{λ_0} is a continuous projection $\mathcal{C} \rightarrow P_{\lambda_0}$, i.e., $\pi_{\lambda_0}^2 = \pi_{\lambda_0}$ and $\operatorname{range} \pi_{\lambda_0} = P_{\lambda_0}$.

b) The subspace P_{λ_0} is invariant with respect to the solution semigroup \mathcal{T} in the sense that for any $\phi \in P_{\lambda_0}$ the solution $x(t; \phi)$ can be extended

to $(-\infty, \infty)$ and $x_t(\phi) \in P_{\lambda_0}$ for $t \in \mathbb{R}$. The subspace Q_{λ_0} is positively invariant with respect to \mathcal{T} . Moreover, we have

$$\mathcal{C} = P_{\lambda_0} \oplus Q_{\lambda_0}. \quad (2.20)$$

c) The subspace Q_{λ_0} is characterized as

$$Q_{\lambda_0} = \{\phi \in \mathcal{C} \mid \hat{x}(\lambda) = \Delta^{-1}(\lambda)p(\lambda; \phi) \text{ is holomorphic at } \lambda_0\}.$$

d) We have

$$Q_{\lambda_0} = \text{range}(\mathcal{A} - \lambda_0 I)^k \quad \text{for } k = \kappa_0, \kappa_0 + 1, \dots,$$

and $\text{range}(\mathcal{A} - \lambda_0 I)^k \not\supseteq Q_{\lambda_0}$ for $k = 0, \dots, \kappa_0 - 1$.

Proof. a) It is obvious that π_{λ_0} is linear. In order to prove boundedness we fix Γ in (2.19). By continuity of $\Delta^{-1}(\lambda)$ on Γ there exists a constant $K > 0$ such that

$$\|e_0(\lambda)\Delta^{-1}(\lambda)\| \leq K \quad \text{for } \lambda \in \Gamma.$$

From Lemma 1.18, b), we get, for a constant $M > 0$,

$$|p(\lambda; \phi)| \leq M\|\phi\| \quad \text{for } \lambda \in \Gamma.$$

Therefore we have ($\rho = \text{radius of } \Gamma$)

$$\|\pi_{\lambda_0}\phi\| \leq 2\pi\rho KM\|\phi\|, \quad \phi \in \mathcal{C}.$$

In order to prove $\text{range } \pi_{\lambda_0} = P_{\lambda_0}$ we choose a $\phi \in P_{\lambda_0}$. ϕ is given as $\phi = \sum_{j=0}^{\kappa_0-1} e_j(\lambda_0)b_j$. Then

$$\hat{x}(\lambda; \phi) = \sum_{j=0}^{\kappa_0-1} (\lambda - \lambda_0)^{-j-1} b_j,$$

which gives

$$\pi_{\lambda_0}\phi = \text{Res}_{\lambda=\lambda_0} e_0(\lambda) \sum_{j=0}^{\kappa_0-1} (\lambda - \lambda_0)^{-j-1} b_j = \sum_{j=0}^{\kappa_0-1} e_j(\lambda_0)b_j = \phi.$$

This proves $\text{range } \pi_{\lambda_0} = P_{\lambda_0}$ and $\pi_{\lambda_0}^2 = \pi_{\lambda_0}$.

b) For $\phi \in P_{\lambda_0}$, $\phi = \sum_{j=0}^{\kappa_0-1} e_j(\lambda_0)b_j$ with $\tilde{\Delta}_{\kappa_0}(\lambda_0)\tilde{b}_{\kappa_0} = 0$, the solution exists on \mathbb{R} . Together with its Laplace-transform it is given by

$$x(t; \phi) = e^{\lambda_0 t} \sum_{j=0}^{\kappa_0-1} \frac{t^j}{j!} b_j, \quad t \in \mathbb{R},$$

$$\hat{x}(\lambda; \phi) = \sum_{j=0}^{\kappa_0-1} (\lambda - \lambda_0)^{-j-1} b_j, \quad \lambda \neq \lambda_0.$$

By Lemma 2.16 we have

$$\begin{aligned} (\pi_{\lambda_0} x_t(\phi))(\theta) &= \operatorname{Res}_{\lambda=\lambda_0} e^{\lambda(t+\theta)} \hat{x}(\lambda; \phi) = e^{\lambda_0(t+\theta)} \sum_{j=0}^{\kappa_0-1} \frac{(t+\theta)^j}{j!} b_j \\ &= x(t+\theta; \phi) = x_t(\phi)(\theta), \quad -r \leq \theta \leq 0, \quad t \geq 0. \end{aligned}$$

This equation is also true for $t < 0$. Fix $t < 0$ and define $y(s) = x(t+s; \phi) = x(s; x_t(\phi))$, $s \geq 0$. The Laplace-transform $\hat{y}(\lambda)$ of $y(s)$ is given by

$$\hat{y}(\lambda) = \int_0^\infty e^{-\lambda s} x(t+s; \phi) ds = e^{\lambda t} \int_t^0 e^{-\lambda \tau} x(\tau; \phi) d\tau + e^{\lambda t} \hat{x}(\lambda; \phi).$$

Since the first term on the right-hand side is entire, we get

$$\operatorname{Res}_{\lambda=\lambda_0} e^{\lambda \theta} \Delta^{-1}(\lambda) p(\lambda; x_t(\phi)) = \operatorname{Res}_{\lambda=\lambda_0} e^{\lambda(t+\theta)} \Delta^{-1} p(\lambda; \phi), \quad -r \leq \theta \leq 0.$$

Using this we get as in the case $t \geq 0$ that $\pi_{\lambda_0} x_t(\phi) = x_t(\phi)$.

In order to prove positive invariance of Q_{λ_0} we use c), which is proved below. Since $\hat{x}(\lambda; \phi) = \Delta^{-1}(\lambda) p(\lambda; \phi)$ for $\phi \in Q_{\lambda_0}$ is holomorphic at λ_0 , we get

$$\operatorname{Res}_{\lambda=\lambda_0} e^{\lambda(t+\theta)} \Delta^{-1}(\lambda) p(\lambda; \phi) = 0 \quad \text{for all } t \geq 0 \text{ and } -r \leq \theta \leq 0.$$

This implies $\pi_{\lambda_0} x_t(\phi) = 0$ for all $t \geq 0$, i.e., $x_t(\phi) \in Q_{\lambda_0}$, $t \geq 0$.

The representation (2.20) follows from $\mathcal{C} = \operatorname{range} \pi_{\lambda_0} \oplus \operatorname{range}(I - \pi_{\lambda_0})$.

c) If $\Delta^{-1}(\lambda) p(\lambda; \phi)$ is holomorphic at λ_0 , then obviously $\pi_{\lambda_0} \phi = 0$, i.e., $\phi \in Q_{\lambda_0}$. Assume now that $\Delta^{-1}(\lambda) p(\lambda; \phi)$ has a pole of order κ , $0 < \kappa \leq \kappa_0$, at λ_0 . Then the Laurent series of $\Delta^{-1}(\lambda) p(\lambda; \phi)$ is of the form

$$(\lambda - \lambda_0)^{-\kappa} q_{-\kappa} + (\lambda - \lambda_0)^{-\kappa+1} q_{-\kappa+1} + \dots$$

with $q_{-\kappa} \neq 0$. This implies

$$\pi_{\lambda_0} \phi = \operatorname{Res}_{\lambda=\lambda_0} e_0(\lambda) \Delta^{-1}(\lambda) p(\lambda; \phi) = e_{\kappa-1}(\lambda_0) q_{-\kappa} + \dots + e_0(\lambda_0) q_{-1} \neq 0,$$

i.e., $\phi \notin Q_{\lambda_0}$.

d) Let $\psi = (\mathcal{A} - \lambda_0 I)^k \phi$ for some $\phi \in \text{dom } \mathcal{A}^k$, i.e.,

$$\psi = \sum_{j=0}^k \binom{k}{j} (-1)^{k-j} \lambda_0^{k-j} \phi^{(j)}. \quad (2.21)$$

It is easy to see that $\phi \in \text{dom } \mathcal{A}$ implies that $x(t; \phi)$ is continuously differentiable on $[-r, \infty)$ and $\dot{x}(t; \phi) = x(t; \dot{\phi})$. By induction we see that $\phi \in \text{dom } \mathcal{A}^k$ implies that $x(t; \phi)$ is k -times continuously differentiable on $[-r, \infty)$ and $x^{(k)}(t; \phi) = x(t; \phi^{(k)})$. Taking Laplace-transforms we get (observe Theorem A.3)

$$\hat{x}(\lambda; \phi^{(k)}) = \Delta^{-1}(\lambda) p(\lambda; \phi^{(k)}) = \lambda^k \Delta^{-1}(\lambda) p(\lambda; \phi) - \sum_{i=0}^{k-1} \lambda^i \phi^{(k-1-i)}(0).$$

This and (2.21) imply

$$\begin{aligned} \Delta^{-1}(\lambda) p(\lambda; \psi) &= \sum_{j=0}^k \binom{k}{j} (-1)^{k-j} \lambda_0^{k-j} \Delta^{-1}(\lambda) p(\lambda; \phi^{(j)}) \\ &= \left(\sum_{j=0}^k \binom{k}{j} (-1)^{k-j} \lambda_0^{k-j} \lambda^j \right) \Delta^{-1}(\lambda) p(\lambda; \phi) + h_k(\lambda; \phi) \\ &= (\lambda - \lambda_0)^k \Delta^{-1}(\lambda) p(\lambda; \phi) + h_k(\lambda; \phi), \end{aligned}$$

where $h_k(\lambda; \phi)$ is holomorphic at λ_0 . If $k \geq \kappa_0$ we see that $\Delta^{-1}(\lambda) p(\lambda; \psi)$ is holomorphic at λ_0 , i.e., $\psi \in Q_{\lambda_0}$ by part c).

If $\psi \in Q_{\lambda_0}$, then $q(\lambda) = \Delta^{-1}(\lambda) p(\lambda; \psi)$ is holomorphic at λ_0 . Therefore we have $p(\lambda; \psi) = \Delta(\lambda) q(\lambda)$ in a neighborhood of λ_0 or, equivalently,

$$\sum_{j=0}^i \frac{1}{j!} \Delta^{(j)}(\lambda_0) q_{i-j} = p_i(\lambda_0; \psi), \quad i = 0, 1, \dots,$$

where $q(\lambda) = \sum_{i=0}^{\infty} (\lambda - \lambda_0)^i q_i$. This shows that equation (2.4) has the solution $\tilde{b}_k = -\text{col}(q_{k-1}, \dots, q_0)$ for any $k = 1, 2, \dots$. By Theorem 2.10 this implies $\psi \in \bigcap_{k=1}^{\infty} \text{range}(\mathcal{A} - \lambda_0 I)^k$. This finishes the proof of $Q_{\lambda_0} = \text{range}(\mathcal{A} - \lambda_0 I)^k$, $k = \kappa_0, \kappa_0 + 1, \dots$.

Suppose that $\text{range}(\mathcal{A} - \lambda_0 I)^k = Q_{\lambda_0}$ for a $k < \kappa_0$. Take $\phi \in \ker(\mathcal{A} - \lambda_0 I)^{\kappa_0}$ such that $\psi = (\mathcal{A} - \lambda_0 I)^k \phi \neq 0$. Note that $\ker(\mathcal{A} - \lambda_0 I)^k \subsetneq \ker(\mathcal{A} - \lambda_0 I)^{\kappa_0}$ for $k = 0, \dots, \kappa_0 - 1$. Then $\psi \in \text{range}(\mathcal{A} - \lambda_0 I)^k = Q_{\lambda_0}$ and $\psi \in \ker(\mathcal{A} - \lambda_0 I)^{\kappa_0 - k} \subset P_{\lambda_0}$ which by $\mathcal{C} = P_{\lambda_0} \oplus Q_{\lambda_0}$ implies $\psi = 0$, a contradiction. ■

For the nonhomogeneous equation we have:

Proposition 2.18 *Let $x(t) = x(t; 0, f)$, $t \geq 0$, be the solution of (1.3), (1.4) with $\phi \equiv 0$ and $f \in L_{\text{loc}}^1(0, \infty; \mathbb{C}^n)$. Then we have*

$$(\pi_{\lambda_0} x_t(0, f))(\theta) = \operatorname{Res}_{\lambda=\lambda_0} e^{\lambda(t+\theta)} \Delta^{-1}(\lambda) \hat{f}(\lambda; t) \quad (2.22)$$

for $-r \leq \theta \leq 0$, $t \geq 0$, where

$$\hat{f}(\lambda; t) = \int_0^t e^{-\lambda\tau} f(\tau) d\tau, \quad t \geq 0.$$

Proof. We fix $t_1 > 0$ and define $f(t; t_1) = f(t)$ for $0 \leq t \leq t_1$ and $= 0$ for $t > t_1$. Since $y(t) = x(t + t_1; 0, f(\cdot; t_1))$, $t \geq 0$, is the solution of the homogeneous problem (1.1), (1.2) with $\phi = x_{t_1}(0, f)$, the definition of π_{λ_0} implies

$$\pi_{\lambda_0} x_{t_1}(0, f) = \operatorname{Res}_{\lambda=\lambda_0} e_0(\lambda) \hat{y}(\lambda),$$

where the Laplace-transform $\hat{y}(\lambda)$ is given by

$$\begin{aligned} \hat{y}(\lambda) &= \int_0^\infty e^{-\lambda t} y(t) dt \\ &= e^{\lambda t_1} \int_0^\infty e^{-\lambda t} x(t; 0, f(\cdot; t_1)) dt - e^{\lambda t_1} \int_0^{t_1} e^{-\lambda t} x(t; 0, f(\cdot; t_1)) dt \\ &= e^{\lambda t_1} \Delta^{-1}(\lambda) \hat{f}(\lambda; t_1) - e^{\lambda t_1} \int_0^{t_1} e^{-\lambda t} x(t; 0, f(\cdot; t_1)) dt, \end{aligned}$$

where we have used (1.30). The result now follows, because the second term on the right-hand side is holomorphic at zero. ■

If, for the matrices D_j , $j = -\kappa_0, \dots, -1$, we define

$$D(t) = e^{\lambda_0 t} \sum_{j=0}^{\kappa_0-1} \frac{t^j}{j!} D_{-j-1}, \quad t \in \mathbb{R}, \quad (2.23)$$

then (2.18) implies that the columns of $D(t)$ are generalized eigenfunctions of equation (1.1) and correspondingly the columns of D_t are in P_{λ_0} . Furthermore, we have

$$D_t(\theta) = \operatorname{Res}_{\lambda=\lambda_0} e^{\lambda(t+\theta)} \Delta^{-1}(\lambda), \quad -r \leq \theta \leq 0, \quad t \geq 0. \quad (2.24)$$

Since $\Delta^{-1}(\lambda)$ is the Laplace-transform of the fundamental matrix $Y(t)$, D_t can be considered as the projection of Y_t into P_{λ_0} ,

$$\pi_{\lambda_0} Y_t = D_t, \quad t \geq 0.$$

Note however, that the columns of Y_t are not in \mathcal{C} for $0 \leq t < r$. We set $\tilde{f}_{\kappa_0}(t) = \text{col}(f_{\kappa_0-1}(t), \dots, f_0(t))$, where

$$f_j(t) = \frac{1}{j!} \frac{d^j}{d\lambda^j} \hat{f}(\lambda; t) |_{\lambda=\lambda_0} = \frac{(-1)^j}{j!} \int_0^t \tau^j e^{-\lambda_0 \tau} f(\tau) d\tau, \quad j = 0, \dots, \kappa_0 - 1,$$

and

$$\tilde{g}_{\kappa_0}(t) = \text{col}(g_0(t), \dots, g_{\kappa_0-1}(t)) = \tilde{D}_{\kappa_0} \tilde{f}_{\kappa_0}(t). \quad (2.25)$$

With these notations we get

$$(\pi_{\lambda_0} x_t(0, f))(\theta) = e^{\lambda_0(t+\theta)} \sum_{j=0}^{\kappa_0-1} \frac{(t+\theta)^j}{j!} g_j(t).$$

Equation (2.25) implies

$$\begin{aligned} g_j(t) &= \sum_{k=j}^{\kappa_0-1} D_{-k-1} f_{k-j}(t) \\ &= \int_0^t e^{\lambda_0 \tau} \left(\sum_{k=j}^{\kappa_0-1} D_{-k-1} \frac{(-\tau)^{k-j}}{(k-j)!} \right) f(\tau) d\tau, \quad j = 0, \dots, \kappa_0 - 1, t \geq 0. \end{aligned}$$

With these expressions we get for $\pi_{\lambda_0} x_t(0, f)$

$$\begin{aligned} (\pi_{\lambda_0} x_t(0, f))(\theta) &= \int_0^t e^{\lambda_0(t+\theta-\tau)} \left(\sum_{j=0}^{\kappa_0-1} \sum_{k=j}^{\kappa_0-1} D_{-k-1} \frac{(-\tau)^{k-j} (t+\theta)^j}{(k-j)! j!} \right) f(\tau) d\tau \\ &= \int_0^t e^{\lambda_0(t+\theta-\tau)} \left(\sum_{k=0}^{\kappa_0-1} \frac{1}{k!} D_{-k-1} \sum_{j=0}^k \frac{k!}{(k-j)! j!} (t+\theta)^j (-\tau)^{k-j} \right) f(\tau) d\tau \\ &= \int_0^t e^{\lambda_0(t+\theta-\tau)} \left(\sum_{k=0}^{\kappa_0-1} \frac{(t-\tau+\theta)^k}{k!} D_{-k-1} \right) f(\tau) d\tau \\ &= \int_0^t D_{t-\tau}(\theta) f(\tau) d\tau, \quad -r \leq \theta \leq 0, t \geq 0. \end{aligned}$$

For the solution of the homogeneous problem (1.1), (1.2) we get from Lemma 2.16 and the proof of Proposition 2.15

$$(\pi_{\lambda_0} x_t(\phi))(\theta) = e^{\lambda_0(t+\theta)} \sum_{j=0}^{\kappa_0-1} \frac{(t+\theta)^j}{j!} c_j, \quad -r \leq \theta \leq 0, t \geq 0, \quad (2.26)$$

where

$$c_j = D_{-j-1} p_0 + \dots + D_{-\kappa_0} p_{\kappa_0-j-1}, \quad j = 0, \dots, \kappa_0 - 1,$$

and

$$p_j = \frac{1}{j!} \frac{d^j}{d\lambda^j} p(\lambda; \phi) \Big|_{\lambda=\lambda_0} = \begin{cases} \phi(0) + \int_{-r}^0 [d\eta(\theta)] \int_{\theta}^0 e^{\lambda_0(\theta-\tau)} \phi(\tau) d\tau & \text{for } j = 0, \\ \frac{1}{j!} \int_{-r}^0 [d\eta(\theta)] \int_{\theta}^0 (\theta - \tau)^j e^{\lambda_0(\theta-\tau)} \phi(\tau) d\tau & \text{for } j = 1, 2, \dots \end{cases}$$

Using Fubini's theorem we get

$$\begin{aligned} \int_{-r}^0 [d\eta(s)] \int_s^0 (s - \tau)^j e^{\lambda_0(s-\tau)} \phi(\tau) d\tau &= \int_{-r}^0 \tau^j e^{\lambda_0\tau} \left(\int_{-r}^{\tau} [d\eta(s)] \phi(s - \tau) \right) d\tau \\ &= \int_0^r (-\tau)^j e^{-\lambda_0\tau} L(\phi_\tau) d\tau, \quad j = 0, 1, \dots \end{aligned}$$

Equation (2.26) implies

$$\begin{aligned} (\pi_{\lambda_0} x_t(\phi))(\theta) &= e^{\lambda_0(t+\theta)} \sum_{j=0}^{\kappa_0-1} \frac{(t+\theta)^j}{j!} D_{-j-1} \phi(0) + e^{\lambda_0(t+\theta)} \sum_{j=0}^{\kappa_0-1} \frac{(t+\theta)^j}{j!} \\ &\quad \times \sum_{k=j}^{\kappa_0-1} \frac{1}{(k-j)!} D_{-k-1} \int_0^r (-\tau)^{k-j} e^{-\lambda_0\tau} L(\phi_\tau) d\tau \\ &= D(t+\theta) \phi(0) + \int_0^r e^{\lambda_0(t-\tau+\theta)} \sum_{k=0}^{\kappa_0-1} \frac{1}{k!} (t-\tau+\theta)^k D_{-k-1} L(\phi_\tau) d\tau \\ &= D_t(\theta) \phi(0) + \int_0^r D_{t-\tau}(\theta) L(\phi_\tau) d\tau, \quad -r \leq \theta \leq 0, t \geq 0. \end{aligned}$$

Thus we have established the following result:

Proposition 2.19 *Let $\phi \in \mathcal{C}$, $f \in L_{\text{loc}}^1(0, \infty; \mathbb{C}^n)$ and $\lambda_0 \in \sigma(L)$ be given. Then we have*

$$\begin{aligned} \pi_{\lambda_0} x_t(\phi, f) &= D_t \phi(0) + \int_0^r D_{t-\tau} L(\phi_\tau) d\tau \\ &\quad + \int_0^t D_{t-\tau} f(\tau) d\tau, \quad t \geq 0. \end{aligned} \tag{2.27}$$

In particular we have, for $\phi \in \mathcal{C}$,

$$(\pi_{\lambda_0} \phi)(\theta) = D(\theta) \phi(0) + \int_0^r D(-\tau + \theta) L(\phi_\tau) d\tau, \quad -r \leq \theta \leq 0.$$

Remark. The above result shows that the projection $\pi_{\lambda_0} x_t(\phi, f)$ is formally obtained from (1.28) and (1.31) by applying the projection π_{λ_0} and observing that $\pi_{\lambda_0} Y_t = D_t$, $t \geq 0$. Furthermore, equation (2.27) for $f \equiv 0$ allows to define the continuation of $z(t) = (\pi_{\lambda_0} x_t(\phi))(0)$ to negative t .

Since P_{λ_0} is invariant with respect to the solution semigroup \mathcal{T} and is finite dimensional, the restriction of \mathcal{T} to P_{λ_0} is generated by a bounded linear operator, i.e., is the solution semigroup of an ordinary differential equation, which we shall compute below.

Let $\tilde{b}_{\kappa_0}^\nu$, $\nu = 1, \dots, \kappa_0$, be a basis for $\ker \tilde{\Delta}_{\kappa_0}(\lambda_0)$. Then (see the proof of Proposition 2.3, b)) the functions

$$\phi^{(\nu)} = \sum_{j=0}^{\kappa_0-1} e_j(\lambda_0) b_j^\nu, \quad \nu = 1, \dots, \kappa_0,$$

where $\tilde{b}_{\kappa_0}^\nu = \text{col}(b_0^\nu, \dots, b_{\kappa_0-1}^\nu)$, constitute a basis for P_{λ_0} . We define

$$\begin{aligned} \tilde{\Phi}_{\kappa_0} &= (\tilde{b}_{\kappa_0}^1, \dots, \tilde{b}_{\kappa_0}^{\kappa_0}) \in \mathbb{C}^{n\kappa_0 \times \kappa_0}, \\ \Phi_j &= (b_j^1, \dots, b_j^{\kappa_0}) \in \mathbb{C}^{n \times \kappa_0}, \quad j = 0, \dots, \kappa_0, \\ \Phi_{\lambda_0}(\theta) &= (\phi^{(1)}(\theta), \dots, \phi^{(\kappa_0)}(\theta)), \quad -r \leq \theta \leq 0. \end{aligned}$$

Then we have $\Phi_{\lambda_0} = \sum_{j=0}^{\kappa_0-1} e_j(\lambda_0) \Phi_j$ and $\tilde{\Phi}_{\kappa_0} = \text{col}(\Phi_0, \dots, \Phi_{\kappa_0-1})$.

For $\phi \in P_{\lambda_0}$ let $a \in \mathbb{C}_{\kappa_0}$ be the coordinate vector of ϕ with respect to the basis $\phi^{(1)}, \dots, \phi^{(\kappa_0)}$, i.e.,

$$\phi = \Phi_{\lambda_0} a = \sum_{j=0}^{\kappa_0-1} e_j(\lambda_0) \Phi_j a.$$

On the other hand we have

$$\phi = \pi_{\lambda_0} \phi = \text{Res}_{\lambda=\lambda_0} e_0(\lambda) \Delta^{-1}(\lambda) p(\lambda; \phi) = \sum_{j=0}^{\kappa_0-1} e_j(\lambda_0) c_j \text{ with } \tilde{c}_{\kappa_0} = \tilde{D}_{\kappa_0} \tilde{p}_{\kappa_0},$$

where $\tilde{c}_{\kappa_0} = \text{col}(c_0, \dots, c_{\kappa_0-1})$, $\tilde{p}_{\kappa_0} = \text{col}(p_{\kappa_0-1}, \dots, p_0)$ (see (2.26) for $\theta = 0$). This implies $c_j = \Phi_j a$, $j = 0, \dots, \kappa_0 - 1$, or equivalently

$$\tilde{\Phi}_{\kappa_0} a = \tilde{D}_{\kappa_0} \tilde{p}_{\kappa_0}. \quad (2.28)$$

Note that $\text{rank } \tilde{\Phi}_{\kappa_0} = \kappa_0$, so that (2.28) has a unique solution.

From $P_{\lambda_0} = \ker(\mathcal{A} - \lambda_0 I)^{\kappa_0}$ and $(\mathcal{A} - \lambda_0 I)^{\kappa_0} \mathcal{A} \phi = (\mathcal{A} - \lambda_0 I)^{\kappa_0+1} \phi + \lambda_0 (\mathcal{A} - \lambda_0 I)^{\kappa_0} \phi$ for $\phi \in P_{\lambda_0}$ we see immediately that $\mathcal{A} P_{\lambda_0} \subset P_{\lambda_0}$.⁴ This

⁴This also follows from $S(t)P_{\lambda_0} \subset P_{\lambda_0}$, $t \geq 0$ (compare Theorem 2.17, b)), of course.

implies

$$\mathcal{A}\Phi_{\lambda_0} = \lambda_0\Phi_{\lambda_0} + \sum_{j=0}^{\kappa_0-2} e_j(\lambda_0)\Phi_{j+1} = \Phi_{\lambda_0}B_{\lambda_0}$$

for some $k_0 \times k_0$ -matrix B_{λ_0} . This equation is equivalent to

$$\tilde{\Phi}_{\kappa_0}B_{\lambda_0} = \lambda_0\tilde{\Phi}_{\kappa_0} + \begin{pmatrix} \Phi_1 \\ \vdots \\ \Phi_{\kappa_0-1} \\ 0 \end{pmatrix}, \quad (2.29)$$

which can be uniquely solved for B_{λ_0} . Since $D_t \in P_{\lambda_0}$, $t \in \mathbb{R}$ (see (2.24)), we have

$$D_t = \Phi_{\lambda_0}H(t), \quad t \in \mathbb{R},$$

for an $n \times k_0$ -matrix $H(t)$. From

$$\begin{aligned} \frac{d}{dt}D(t+\theta) &= \Phi_{\lambda_0}(\theta)\dot{H}(t) = \frac{d}{d\theta}D(t+\theta) = \frac{d}{d\theta}\Phi_{\lambda_0}(\theta)H(t) \\ &= \phi_{\lambda_0}(\theta)B_{\lambda_0}H(t), \quad t \in \mathbb{R}, \quad -r \leq \theta \leq 0, \end{aligned}$$

we get $\dot{H}(t) = B_{\lambda_0}H(t)$, $t \in \mathbb{R}$, i.e.,

$$H(t) = e^{B_{\lambda_0}t}H_{\lambda_0}, \quad t \in \mathbb{R},$$

where H_{λ_0} is determined by $D(\theta) = \Phi_{\lambda_0}(\theta)H_{\lambda_0}$, $-r \leq \theta \leq 0$.

Theorem 2.20 *Let $\lambda_0 \in \sigma(L)$ and a basis Φ_{λ_0} of P_{λ_0} be given. For $\phi \in \mathcal{C}$ and $f \in L_{\text{loc}}^1(0, \infty; \mathbb{C}^n)$ let $y(t)$ be the coordinate vector of $\pi_{\lambda_0}x_t(\phi, f)$ with respect to Φ_{λ_0} , i.e., $\pi_{\lambda_0}x_t(\phi, f) = \Phi_{\lambda_0}y(t)$, $t \geq 0$. Then $y(t)$ is the solution of*

$$\begin{aligned} \dot{y}(t) &= B_{\lambda_0}y(t) + H_{\lambda_0}f(t), \quad t \geq 0, \\ y(0) &= a, \end{aligned} \quad (2.30)$$

where $\pi_{\lambda_0}\phi = \Phi_{\lambda_0}a$. The coordinate vector a of $\pi_{\lambda_0}\phi$ can be computed from

$$\tilde{\Phi}_{\kappa_0}a = \tilde{D}_{\kappa_0}\tilde{p}_{\kappa_0},$$

where $\tilde{p}_{\kappa_0} = \text{col}(p_{\kappa_0-1}, \dots, p_0)$, $p_j = \frac{d^j}{d\lambda^j}p(\lambda; \phi) |_{\lambda=\lambda_0}$, $j = 0, \dots, \kappa_0 - 1$. The matrix B_{λ_0} is the solution of (2.29) and H_{λ_0} solves

$$\tilde{\Phi}_{\kappa_0}H_{\lambda_0} = \begin{pmatrix} D_{-1} \\ \vdots \\ D_{-\kappa_0} \end{pmatrix}.$$

Proof. From Proposition 2.19 and the definition of $H(t)$ we see that

$$\pi_{\lambda_0}\phi = \Phi_{\lambda_0}\left(H_{\lambda_0}\phi(0) + \int_0^r e^{-B_{\lambda_0}\tau} H_{\lambda_0}L(\phi_\tau) d\tau\right),$$

so that $a = H_{\lambda_0}\phi(0) + \int_0^r e^{-B_{\lambda_0}\tau} H_{\lambda_0}L(\phi_\tau) d\tau$. Equation (2.27) implies

$$\begin{aligned} \Phi_{\lambda_0}y(t) &= \Phi_{\lambda_0}e^{B_{\lambda_0}t}\left(H_{\lambda_0}\phi(0) + \int_0^r e^{-B_{\lambda_0}\tau} H_{\lambda_0}L(\phi_\tau) d\tau\right) \\ &\quad + \Phi_{\lambda_0}\int_0^t e^{B_{\lambda_0}(t-\tau)} H_{\lambda_0}f(\tau) d\tau, \quad t \geq 0, \end{aligned}$$

i.e., $y(t) = e^{B_{\lambda_0}t}a + \int_0^t e^{B_{\lambda_0}(t-\tau)} H_{\lambda_0}f(\tau) d\tau$, which proves (2.30).

The equation for a given in the theorem is just (2.28). The equation for H_{λ_0} follows from

$$D(\theta) = \sum_{j=0}^{\kappa_0-1} e_j(\lambda_0)(\theta)D_{-j-1} = \Phi_{\lambda_0}H_{\lambda_0} = \sum_{j=0}^{\kappa_0-1} e_j(\lambda_0)(\theta)\phi_j H_{\lambda_0}$$

for $-r \leq \theta \leq 0$ or, equivalently,

$$D_{-j-1} = \Phi_j H_{\lambda_0}, \quad j = 0, \dots, \kappa_0 - 1.$$

■

2.3 Exponential dichotomy of the state space

According to Corollary 1.17 the set

$$\Lambda_\alpha = \{\lambda \in \sigma(L) \mid \operatorname{Re} \lambda \geq \alpha\} \quad (2.31)$$

is finite for any $\alpha \in \mathbb{R}$. Let $\lambda_1, \dots, \lambda_N$ be the elements in Λ_α and denote by k_i the multiplicity of λ_i , $i = 1, \dots, N$. We set

$$P_{\Lambda_\alpha} = \bigcup_{i=1}^N P_{\lambda_i}, \quad Q_{\Lambda_\alpha} = \bigcap_{i=1}^N Q_{\lambda_i}. \quad (2.32)$$

Then $\mathcal{C} = P_{\Lambda_\alpha} \oplus Q_{\Lambda_\alpha}$ and (see Theorem 2.17,c))

$$Q_{\Lambda_\alpha} = \{\phi \in \mathcal{C} \mid \Delta^{-1}(\lambda)p(\lambda; \phi) \text{ is holomorphic for } \operatorname{Re} \lambda \geq \alpha\}.$$

If we define

$$\begin{aligned} \Phi_{\Lambda_\alpha} &= (\Phi_{\lambda_1}, \dots, \Phi_{\lambda_N}), \quad \text{where } \phi_{\lambda_i} \text{ is a basis for } P_{\lambda_i}, \quad i = 1, \dots, N, \\ B_{\Lambda_\alpha} &= \operatorname{diag}(B_{\lambda_1}, \dots, B_{\lambda_N}) \end{aligned}$$

and, for $\phi \in P_{\Lambda_\alpha}$, $y(t) \in \mathbb{C}^{k_1+\dots+k_N}$ by

$$x_t(\phi) = \Phi_{\Lambda_\alpha} y(t), \quad t \in \mathbb{R}, \quad (2.33)$$

then $y(t)$ solves

$$\dot{y}(t) = B_{\Lambda_\alpha} y(t), \quad t \in \mathbb{R}, \quad \Phi_{\Lambda_\alpha} y(0) = \phi.$$

From Corollary 1.17 it also follows that there exists a $\gamma > 0$ such that

$$\operatorname{Re} \lambda \leq \alpha - 2\gamma \quad \text{for all } \lambda \in \sigma(L) \setminus \Lambda_\alpha.$$

This implies (see Definition 1.19) that

$$\omega_{L,\phi} \leq \alpha - 2\gamma \quad \text{for all } \phi \in Q_{\Lambda_\alpha}.$$

Let $\phi \in Q_{\Lambda_\alpha}$ be such that $\omega_{L,\phi} = \max_{\psi \in Q_{\Lambda_\alpha}} \omega_{L,\psi}$. Then according to Theorem 1.21, b) there exists a constant $K = K(\alpha, \gamma) \geq 1$ such that

$$|x(t; \psi)| \leq K \|\psi\| e^{(\omega_{L,\phi} + \gamma)t} \leq K \|\psi\| e^{(\alpha - \gamma)t}, \quad t \geq 0, \quad \psi \in Q_{\Lambda_\alpha}.$$

This implies (with $\tilde{K} = K \max(1, e^{-(\alpha - \gamma)r})$)

$$\|x_t(\psi)\| \leq \tilde{K} \|\psi\| e^{(\alpha - \gamma)t}, \quad \psi \in Q_{\Lambda_\alpha}, \quad t \geq 0.$$

The only eigenvalues of B_{Λ_α} are $\lambda_1, \dots, \lambda_N$. Therefore, for any $\gamma > 0$, there exists a $K_1 \geq 1$ such that

$$|y(t)| \leq K_1 |y(0)| e^{(\alpha - \gamma)t}, \quad t \leq 0, \quad (2.34)$$

where $y(t)$ is defined in (2.33). If we define the norm on $\mathbb{C}^{k_1+\dots+k_N}$ by $|z| = \|\Phi_\alpha z\|$, then (2.34) is equivalent to

$$\|x_t(\phi)\| \leq K_1 \|\phi\| e^{(\alpha - \gamma)t}, \quad \phi \in P_{\Lambda_\alpha}, \quad t \leq 0.$$

Thus we have proved the following theorem:

Theorem 2.21 *For $\alpha \in \mathbb{R}$ let Λ_α and Q_{Λ_α} , P_{Λ_α} be defined by (2.31) and (2.32), respectively. Furthermore, define the projection $\pi_{\Lambda_\alpha} : \mathcal{C} \rightarrow P_{\Lambda_\alpha}$ by*

$$\pi_{\Lambda_\alpha} \phi = \sum_{i=1}^N \pi_{\lambda_i} \phi, \quad \phi \in \mathcal{C}.$$

Then there exist constants $\gamma > 0$ and $K = K(\alpha, \gamma) \geq 1$ such that, for any $\phi \in \mathcal{C}$,

$$\|\pi_{\Lambda_\alpha} x_t(\phi)\| \leq K \|\pi_{\Lambda_\alpha} \phi\| e^{(\alpha - \gamma)t}, \quad t \leq 0, \quad (2.35)$$

$$\|(I - \pi_{\Lambda_\alpha}) x_t(\phi)\| \leq K \|(I - \pi_{\Lambda_\alpha}) \phi\| e^{(\alpha - \gamma)t}, \quad t \geq 0. \quad (2.36)$$

In many cases Theorem 2.21 allows to reduce a problem for functional differential equations to a problem for ordinary differential equations. As an example we prove below a characterization of stability resp. asymptotic stability for equations (1.1) which parallels the corresponding result for ordinary differential equations.

Definition 2.22 a) Equation (1.1) is called **stable** if and only if there exists a constant $K \geq 1$ such that, for all $\phi \in \mathcal{C}$,

$$\|x_t(\phi)\| \leq K\|\phi\|, \quad t \geq 0.$$

b) Equation (1.1) is called **asymptotically stable** if and only if it is stable and

$$\lim_{t \rightarrow \infty} \|x_t(\phi)\| = 0 \quad \text{for all } \phi \in \mathcal{C}.$$

c) Equation (1.1) is called **exponentially stable** if there exist constants $K \geq 1$ and $\beta > 0$ such that, for all $\phi \in \mathcal{C}$,

$$\|x_t(\phi)\| \leq K\|\phi\|e^{-\beta t}, \quad t \geq 0.$$

Theorem 2.23 a) Equation (1.1) is stable if and only if for all eigenvalues $\lambda_0 \in \sigma(L)$ the following two conditions are satisfied:

(i) $\operatorname{Re} \lambda_0 \leq 0$.

(ii) If $\operatorname{Re} \lambda_0 = 0$ then all subspaces of P_{λ_0} which are cyclic with respect to \mathcal{A} are one-dimensional, i.e., either

$$k_0 < n \quad \text{and} \quad \operatorname{rank} \Delta(\lambda_0) = n - k_0$$

or

$$k_0 = n, \quad \Delta(\lambda_0) = 0 \quad \text{and} \quad \operatorname{rank} \Delta'(\lambda_0) = n$$

(k_0 is the multiplicity of λ_0).

In case of the scalar n -th order equation (2.14) condition (ii) can be replaced by

(ii') $\operatorname{Re} \lambda_0 = 0$ and λ_0 is a simple root of $\det \Delta(\lambda)$.

b) Equation (1.1) is asymptotically stable if and only if it is exponentially stable, which is the case if and only if condition (i) is satisfied.

Proof. We choose $\alpha = 0$ in Theorem 2.21. If all eigenvalues satisfy condition (i), then $\Lambda_0 = \emptyset$, i.e., $(I - \pi_{\Lambda_0})x_t(\phi) = x_t(\phi)$, $t \geq 0$, and

the inequality (2.36) implies exponential stability. If on the other hand (1.1) is asymptotically stable, then (i) must hold. Indeed, if $\operatorname{Re} \lambda_0$ is an eigenvalue, then there exists a solution of the form $be^{\lambda_0 t}$ with $b \neq 0$ satisfying $\Delta(\lambda_0)b = 0$. Asymptotic stability implies $\operatorname{Re} \lambda_0 < 0$.

If $\Lambda_0 \neq \emptyset$ and (ii) holds, then there is a finite number of eigenvalues on the imaginary axis. The solution with initial function $\phi \in P_{\lambda_0}$ is bounded on $t \geq 0$ if and only if all cyclic subspaces of P_{λ_0} are one-dimensional. Then the result on stability follows immediately from Proposition 2.13, a). ■

3. Small Solutions and Completeness

3.1 Small solutions

We define the subspaces

$$Q = \bigcap_{\lambda \in \sigma(L)} Q_\lambda \quad \text{and} \quad P = \bigoplus_{\lambda \in \sigma(L)} P_\lambda$$

of \mathcal{C} . From invariance of Q_λ and P_λ it follows that the closed subspaces Q and \bar{P} are positively invariant with respect to the solution semigroup \mathcal{T} .⁵

In this section we shall investigate solutions of problem (1.1), (1.2) with $\phi \in Q$. Obviously we have

$$Q = \bigcap_{\alpha \in \mathbb{R}} Q_{\Lambda_\alpha}.$$

Let $\phi \in Q$ be given. Then Theorem 2.21 implies that for any $\alpha \in \mathbb{R}$ there exists a constant $K = K(\alpha) \geq 1$ with

$$|x(t; \phi)| \leq \|x_t(\phi)\| \leq K \|\phi\| e^{\alpha t}, \quad t \geq 0.$$

This is equivalent to

$$\omega_{L, \phi} = \limsup_{t \rightarrow \infty} \frac{1}{t} \ln |x(t; \phi)| = \lim_{t \rightarrow \infty} \frac{1}{t} \ln |x(t; \phi)| = -\infty$$

respectively to $\lim_{t \rightarrow \infty} e^{\beta t} x(t; \phi) = 0$ for all $\beta \in \mathbb{R}$. This motivates the following definition:

⁵Note that P itself is invariant in the sense of Theorem 2.17, b).

Definition 3.1 A solution $x(t; \phi)$ of problem (1.1), (1.2) is called a **small solution** if and only if $x(\cdot; \phi) \not\equiv 0$ on $[-r, \infty)$ and

$$\lim_{t \rightarrow \infty} e^{\beta t} x(t; \phi) = 0 \quad \text{for all } \beta \in \mathbb{R}.$$

From the considerations before Definition 3.1 and the obvious fact that the Laplace-transform of a small solution is an entire function it follows that Q is the subspace of initial values for small solutions of equation (1.1). It is easy to see that there exist equations with $Q \neq \emptyset$. Take for instance

$$\dot{x}(t) = Ax(t - 1), \quad t \geq 0,$$

with an $n \times n$ -matrix A such that $A \neq 0$ and $A^2 = 0$ (which implies $n \geq 2$). We choose

$$\phi(\theta) = \frac{1}{2}Ab + b\theta, \quad -r \leq \theta \leq 0,$$

where $Ab \neq 0$. Note that $\phi(\theta) \neq 0$ on $[-r, 0]$, because $\phi(\theta_0) = 0$ would imply $Ab = -\frac{1}{2}\theta_0 b$. But A does not have nonzero eigenvalues and $Ab \neq 0$. So neither $\theta_0 < 0$ nor $\theta_0 = 0$ is possible. On $[0, 1]$ the solution is given by

$$x(t; \phi) = \phi(0) + \int_0^t A\phi(\tau - 1) d\tau = \frac{1}{2}Ab(t - 1)^2, \quad 0 \leq t \leq 1,$$

which shows $x(t; \phi) \neq 0$ on $[0, 1)$. On $[1, 2]$ we have

$$\begin{aligned} x(t; \phi) &= x(1; \phi) + \int_1^t Ax(\tau - 1; \phi) d\tau \\ &= \frac{1}{2}A^2b \int_1^t (\tau - 2)^2 d\tau = 0, \quad 1 \leq t \leq 2. \end{aligned}$$

This implies $x(t; \phi) = 0$ for $t \geq 1$ and consequently $\phi \in Q$.

The main result of this section is that all small solutions of equations of the form (1.1) behave like the solution constructed in the example above.

Theorem 3.2 Let $\phi \in \mathcal{C}$, $\phi \neq 0$, be given. Then the following is true:

a) $x(t; \phi)$ is a small solution of equation (1.1) if and only if there exists a $t_1 > -r$ such that $x(t; \phi) = 0$ for all $t \geq t_1$.

b) Define the numbers

$$\begin{aligned} \xi &= \limsup_{\rho \rightarrow \infty} \frac{1}{\rho} \ln |\det \Delta(-\rho)| \\ \sigma &= \limsup_{\rho \rightarrow \infty} \frac{1}{\rho} \ln |\text{adj } \Delta(-\rho)|. \end{aligned}$$

If $x(t; \phi)$ is a small solution of equation (1.1) then the number

$$t_\phi = \min\{t_1 \mid x(t; \phi) = 0 \text{ for all } t \geq t_1\}$$

is given by

$$t_\phi = \limsup_{\rho \rightarrow \infty} \frac{1}{\rho} \ln |\text{adj } \Delta(-\rho)q(-\rho; \phi)| - \xi, \tag{3.1}$$

where

$$q(\lambda; \phi) = \phi(0) - \int_{-r}^0 [d\eta(\theta)] \int_{-r}^\theta e^{\lambda(\theta-\tau)} \phi(\tau) d\tau + \lambda \int_{-r}^0 e^{-\lambda\tau} \phi(\tau) d\tau, \quad \lambda \in \mathbb{C}.$$

Moreover, we have the estimate

$$-r < t_\phi \leq \sigma - \xi. \tag{3.2}$$

Proof. a) If $x(t; \phi) = 0$ for $t \geq t_1 > -r$, then trivially it is a small solution. Conversely let $x(t; \phi)$ be a small solution, i.e., $\phi \in Q$ or equivalently $\Delta^{-1}(\lambda)p(\lambda; \phi)$ is entire. From (1.11) we get the estimate

$$\left| \int_{-r}^0 e^{\lambda\theta} d\eta_{ij}(\theta) \right| \leq e^{|\lambda|r} \text{var}_{[-r,0]} \eta_{ij}, \quad \lambda \in \mathbb{C}.$$

Therefore we have

$$|\text{adj } \Delta(\lambda)| \leq a_0 e^{|\lambda|(n-1)r} \quad \text{and} \quad |\det \Delta(\lambda)| \leq a_1 e^{|\lambda|nr}, \quad \lambda \in \mathbb{C}, \tag{3.3}$$

with positive constants a_0 and a_1 . For $p(\lambda; \phi)$ we obtain (compare the proof of the estimate (1.40))

$$|p(\lambda; \phi)| \leq (1 + \ell r e^{|\lambda|r}) \|\phi\|, \quad \lambda \in \mathbb{C}.$$

Thus the functions $\text{adj } \Delta(\lambda)p(\lambda; \phi)$ and $\det \Delta(\lambda)$ are entire functions of exponential type. Since the quotient $\Delta^{-1}(\lambda)p(\lambda; \phi)$ is also entire, it is also of exponential type by Proposition B.2.

By Lemma 1.18 we have the estimate

$$|\Delta^{-1}(\lambda)p(\lambda; \phi)| \leq K \|\phi\| \frac{1}{|\omega| + 1}, \quad \omega \in \mathbb{R},$$

which shows that $\hat{x}(i\omega; \phi) = \Delta^{-1}(i\omega)p(i\omega; \phi)$ is square integrable on \mathbb{R} . An application of Theorem B.6 proves the result in case $\hat{x}(\lambda; \phi) \not\equiv 0$. If $\hat{x}(\lambda; \phi) \equiv 0$, then $x(t; \phi) \equiv 0$ on $t \geq 0$ by Theorem A.1.

b) Theorem B.6 applied to $\hat{x}(\lambda; \phi)$ gives also a precise characterization of the minimal interval which contains the support of $x(t; \phi)$, i.e., of

$t_\phi > 0$, in case $\hat{x}(\lambda; \phi) \not\equiv 0$. Since we want to characterize t_ϕ also for small solutions with $t_\phi < 0$, we have to investigate the Laplace-transform of $y(t) = x(t - r; \phi)$, $t \geq 0$. An easy calculation shows that

$$\hat{y}(\lambda) = e^{-\lambda r} \hat{x}(\lambda; \phi) + e^{-\lambda r} \int_{-r}^0 e^{-\lambda \tau} \phi(\tau) d\tau,$$

which can be written as

$$\hat{y}(\lambda) = e^{-\lambda r} \Delta^{-1}(\lambda) q(\lambda; \phi),$$

where

$$\begin{aligned} q(\lambda; \phi) &= p(\lambda; \phi) + \Delta(\lambda) \int_{-r}^0 e^{-\lambda \tau} \phi(\tau) d\tau \\ &= \phi(0) - \int_{-r}^0 [d\eta(\theta)] \int_{-r}^\theta e^{\lambda(\theta-\tau)} \phi(\tau) d\tau + \lambda \int_{-r}^0 e^{-\lambda \tau} \phi(\tau) d\tau. \end{aligned}$$

Since $\hat{x}(\lambda; \phi)$ is an entire function of exponential type, the same is true for $\hat{y}(\lambda)$. Moreover, $\hat{y}(\lambda) \not\equiv 0$, because $\phi \not\equiv 0$. Since $x(t; \phi)$ is a small solution, the function $y(t)$ has compact support on $[0, \infty)$. Theorem B.6 implies that $y(t) = x(t - r; \phi) = 0$ for $t \geq t_0$, where

$$\begin{aligned} t_0 = h_{\hat{y}}(\pi) &= \limsup_{\rho \rightarrow \infty} \frac{1}{\rho} \ln e^{r\rho} |\Delta^{-1}(-\rho) q(-\rho; \phi)| \\ &= r + \limsup_{\rho \rightarrow \infty} \frac{1}{\rho} \ln |\Delta^{-1}(-\rho) q(-\rho; \phi)|. \end{aligned}$$

The number t_0 cannot be replaced by a smaller one. This proves

$$t_\phi = t_0 - r = \limsup_{\rho \rightarrow \infty} \frac{1}{\rho} \ln |\Delta^{-1}(-\rho) q(-\rho; \phi)|.$$

In the remaining part of the proof we show that the exponential type ξ of $\det \Delta(-\rho)$ can be split off in the formula for t_ϕ . We shall need the following estimates:

$$\begin{aligned} |\det \Delta(i\omega)| &= O(|\omega|^n) && \text{as } |\omega| \rightarrow \infty, \\ |\text{adj } \Delta(i\omega)| &\leq O(|\omega|^{n-1}) && \text{as } |\omega| \rightarrow \infty, \\ |q(i\omega; \phi)| &\leq O(|\omega|) && \text{as } |\omega| \rightarrow \infty. \end{aligned}$$

The first two estimates are immediate consequences of (1.11) for $\text{Re } \lambda = 0$ and the definition of $\Delta(\lambda)$. The third estimate follows from

$$|q(i\omega; \phi)| \leq (1 + \ell r + |\omega| r) \|\phi\|, \quad \omega \in \mathbb{R}.$$

The above estimates show that the integrals

$$\int_{-\infty}^{\infty} \frac{\ln^+ |\det \Delta(i\omega)|}{1 + \omega^2} d\omega \quad \text{and} \quad \int_{-\infty}^{\infty} \frac{\ln^+ |g(i\omega)|}{1 + \omega^2} d\omega$$

exist, where we have set

$$g(\lambda) = \text{adj } \Delta(\lambda)q(\lambda; \phi).$$

By Theorem B.5 the indicator functions of $\det \Delta(\lambda)$ and $g(\lambda)$ are given by

$$\begin{aligned} h_{\det \Delta(\lambda)}(\alpha) &= -h_{\det \Delta(\lambda)}(\pi) \cos \alpha, \\ h_{g(\lambda)}(\alpha) &= -h_{g(\lambda)}(\pi) \cos \alpha \end{aligned}$$

for $\pi/2 \leq \alpha \leq 3\pi/2$. Moreover, for a dense subset of $[\pi/2, 3\pi/2]$ the ‘lim sup’ in the definition of the indicator function can be replaced by ‘lim’. This shows that for α in a dense subset of $[\pi/2, 3\pi/2]$ we have

$$\begin{aligned} \limsup_{\rho \rightarrow \infty} \frac{1}{\rho} \ln |\Delta^{-1}(-\rho)q(-\rho; \phi)| &= \limsup_{\rho \rightarrow \infty} \frac{1}{\rho} \ln \left| \frac{1}{\det \Delta(\rho e^{i\alpha})} g(\rho e^{i\alpha}) \right| \\ &= \limsup_{\rho \rightarrow \infty} \frac{1}{\rho} (\ln |g(\rho e^{i\alpha})| - \ln |\det \Delta(\rho e^{i\alpha})|) \\ &= \limsup_{\rho \rightarrow \infty} \frac{1}{\rho} \ln |g(\rho e^{i\alpha})| - \lim_{\rho \rightarrow \infty} \ln |\det \Delta(\rho e^{i\alpha})| \\ &= -(h_{g(\lambda)}(\pi) - h_{\det \Delta(\lambda)}(\pi)) \cos \alpha. \end{aligned}$$

This implies that

$$\limsup_{\rho \rightarrow \infty} \frac{1}{\rho} \ln |\Delta^{-1}(-\rho)q(-\rho; \phi)| = h_{g(\lambda)}(\pi) - h_{\det \Delta(\lambda)}(\pi),$$

which is equation (3.1). It remains to prove the estimate (3.2). We have

$$\begin{aligned} h_{g(\lambda)}(\pi) &\leq \limsup_{\rho \rightarrow \infty} \frac{1}{\rho} \ln |\text{adj } \Delta(-\rho)| + \limsup_{\rho \rightarrow \infty} \frac{1}{\rho} \ln |q(-\rho; \phi)| \\ &\leq \sigma + 0, \end{aligned}$$

where we have used (3.3) and

$$|q(-\rho; \phi)| \leq (1 + \ell r + \rho r) \|\phi\|, \quad \rho > 0.$$

■

3.2 Completeness of generalized eigenfunctions

The subspace Q of initial functions for small solutions of equation (1.1) is of central importance for the problem of completeness of generalized eigenfunctions of equation (1.1) in \mathcal{C} .

Definition 3.3 *We say that the generalized eigenfunctions of equation (1.1) are **complete** in \mathcal{C} if and only if*

$$\overline{P} = \mathcal{C},$$

i.e., for any $\phi \in \mathcal{C}$ there exists a sequence $\psi_n, n = 1, 2, \dots$, such that each ψ_n is a finite sum of generalized eigenfunctions of equation (1.1) and $\|\phi - \psi_n\| \rightarrow 0$ as $n \rightarrow \infty$.

The following result on $\ker T(t)$ is easy to prove:

Proposition 3.4 *Let*

$$\xi = \limsup_{\rho \rightarrow \infty} \frac{1}{\rho} \ln |\det \Delta(-\rho)| \text{ and } \sigma = \limsup_{\rho \rightarrow \infty} \frac{1}{\rho} \ln |\text{adj } \Delta(-\rho)|.$$

Then we have

$$\ker T(t) = Q \text{ for all } t \geq \sigma - \xi.$$

Proof. If $\phi \in \ker T(t_1)$ for a $t_1 \geq 0$, then $T(t)\phi = T(t-t_1)T(t_1)\phi = 0$ for all $t \geq t_1$, i.e., $x(t; \phi)$ is a small solution of equation (1.1) and therefore we have $\phi \in Q$. On the other hand, from (3.2) it is obvious that $Q \subset \ker T(t)$ for $t \geq \sigma - \xi$. ■

An analogous result on the range of $T(t)$ is much more difficult to prove:

Theorem 3.5 *Let ξ and σ be defined as in Proposition 3.4. Then we have*

$$\overline{\text{range } T(t)} = \overline{P} \text{ for all } t \geq \sigma - \xi. \tag{3.4}$$

For a proof of this theorem we refer to [12, Section 7.8] and the literature quoted there. The proof is based on duality theory for equation (1.1) and the fact that the existence of small solutions to the equation which corresponds to the adjoint semigroup can be characterized in the same way as for (1.1). Moreover, in [12] it is proved that $\alpha = \sigma - \xi$ is the exact number such that (3.4) holds for $t \geq \alpha$.

An immediate consequence of Theorem 3.5 is the following characterization of completeness:

Corollary 3.6 *The eigenfunctions of (1.1) are complete in \mathcal{C} if and only if $Q = \{0\}$, which in turn is equivalent to $\xi = nr$.*

4. Degenerate delay equations

4.1 A necessary and sufficient condition

In this section we restrict ourselves to degenerate equations of type (1.1) and refer for non-autonomous equations to [18] for results and literature. L. Weiss considered in his 1967 paper [30] controllability and in particular null-controllability for linear control systems with time delay in the state equation. For ODE-systems a necessary and sufficient condition for null-controllability is that a certain matrix – the so called controllability Grammian – has full rank. For delay systems of retarded type this condition is only sufficient. The proof of necessity would require that the solutions of the delay equation at any time $t \geq 0$ span all of \mathbb{R}^n , a property which for ODE-systems clearly is satisfied. Simple examples (see for instance [10, p. 41]) show that there exist non-autonomous linear scalar equations such that all solutions are zero after some fixed time-interval. L. Weiss posed the question if an analogous phenomenon is also possible for equations of the form

$$\dot{x}(t) = A_0x(t) + A_1x(t - r)$$

More precisely, the question is, if there exists a $t_1 > 0$ and a vector $q \in \mathbb{R}^n$, $q \neq 0$, such that $q^\top x(t; \phi) = 0$ for all solutions of the difference-differential equation and all $t \geq t_1$.

In this chapter we only present a few important fact on degenerate systems and refer to [18], [19] for further results, for references and constructions of degenerate systems. Some parts of the treatment of the degeneracy problem parallel the investigations of small solutions in Section 10. For the rest of the chapter we assume that the delay equations we consider have complex valued right-hand sides.

Definition 4.1 *System (1.1) is called **degenerate** if and only if there exists a vector $q \in \mathbb{C}^n \setminus \{0\}$ such that⁶*

$$\lim_{t \rightarrow \infty} q^* e^{\gamma t} x(t; \phi) = 0 \quad \text{for all } \gamma \in \mathbb{R} \text{ and all } \phi \in \mathcal{C}. \quad (4.1)$$

*If this condition holds, we call system (1.1) **degenerate with respect to q** .*

A first result is the following:

⁶For a vector $a \in \mathbb{C}^n$ resp. a matrix $A \in \mathbb{C}^{n \times n}$ the conjugate transposed is denoted by a^* resp. by A^* .

Proposition 4.2 *System (1.1) is degenerate with respect to $q \in \mathbb{C}^n \setminus \{0\}$ if and only if*

$$q^* \Delta^{-1}(\lambda)p(\lambda; \phi) \quad \text{is entire for all } \phi \in \mathcal{C}. \tag{4.2}$$

*If this condition holds, then there exists a $t_1 > 0$ such that $q^*x(t; \phi) = 0$ for all $\phi \in \mathcal{C}$ and all $t \geq t_1$. The smallest t_1 with this properties is called the **degeneracy time** of system (1.1).*

Proof. Assume first that (4.1) holds and fix $\phi \in \mathcal{C}$. For any $\gamma \in \mathbb{R}$ we have

$$\int_0^\infty e^{-\gamma t} |q^*x(t; \phi)| dt = \int_0^\infty e^{(-\gamma+1)t} e^{-t} |q^*x(t; \phi)| dt.$$

In view of (4.1) there exists an $M > 0$ with $e^{(-\gamma+1)t} |q^*x(t; \phi)| \leq M$, $t \geq 0$. This implies

$$\int_0^\infty e^{-\gamma t} |q^*(t; \phi)| dt \leq M.$$

Thus we have shown that the Laplace-integral for $q^*x(t; \phi)$ converges absolutely for all $\lambda \in \mathbb{C}$, i.e., $q^* \Delta^{-1}(\lambda)p(\lambda; \phi)$ is entire.

Next assume that (4.2) holds. We cannot have $q^* \Delta^{-1}(\lambda)p(\lambda; \phi) \equiv 0$ for all $\phi \in \mathcal{C}$. Assume that this is the case. Then we have $q^*x(t; \phi) = 0$ for all $t \geq 0$, which for $t = 0$ implies $q = 0$, a contradiction. Choose $\phi \in \mathcal{C}$ such that $q^* \Delta^{-1}(\lambda)p(\lambda; \phi) \not\equiv 0$.

From Lemma 1.18 with $\alpha = 0$ we get the estimate

$$|q^* \Delta^{-1}(\lambda)p(\lambda; \phi)| \leq |q| \frac{\text{const.}}{|\lambda|} \|\phi\|$$

for $\text{Re } \lambda \geq 0$ and $|\lambda|$ sufficiently large. This proves that $q^* \Delta^{-1}(\lambda)p(\lambda; \phi)$ is square-integrable on $\lambda = i\omega$, $\omega \in \mathbb{R}$. Then the Paley-Wiener theorem (see Theorem B.6) implies that there exists a $t_\phi > 0$ such that

$$q^*x(t; \phi) = 0 \quad \text{for } t \geq t_\phi.$$

The number t_ϕ is given by

$$t_\phi = \limsup_{\rho \rightarrow \infty} \frac{1}{\rho} \ln |q^* \Delta^{-1}(-\rho)p(-\rho; \phi)|$$

and cannot be replaced by a smaller number. As in the proof of Theorem 3.2 we see that

$$t_\phi = \limsup_{\rho \rightarrow \infty} \frac{1}{\rho} \ln |q^* \text{adj } \Delta(-\rho)p(-\rho; \phi)| - \xi,$$

where ξ is defined in Theorem 3.2. Using the estimate

$$|p(-\rho; \phi)| \leq (1 + re^{\rho r}) \|\phi\| \quad \text{for } \rho \geq 0$$

we obtain

$$\begin{aligned} \limsup_{\rho \rightarrow \infty} \frac{1}{\rho} \ln |q^* \operatorname{adj} \Delta(-\rho) p(-\rho; \phi)| \\ \leq \limsup_{\rho \rightarrow \infty} \frac{1}{\rho} \ln |q^* \operatorname{adj} \Delta(-\rho)| + \limsup_{\rho \rightarrow \infty} \frac{1}{\rho} \ln (e^{\rho r} (r+1) \|\phi\|) \\ = \limsup_{\rho \rightarrow \infty} \frac{1}{\rho} \ln |q^* \operatorname{adj} \Delta(-\rho)| + r. \end{aligned}$$

Using the estimate (1.36) we easily get

$$\limsup_{\rho \rightarrow \infty} \frac{1}{\rho} \ln |q^* \operatorname{adj} \Delta(-\rho)| \leq (n-1)r.$$

Thus we have established that

$$0 < t_\phi \leq (n-1)r + r - \xi = nr - \xi \quad \text{for all } \phi \in \mathcal{C}. \quad \blacksquare$$

The proof of Proposition 4.2 provides also an estimate for the degeneracy time:

$$0 < t_1 \leq nr. \quad (4.3)$$

The following result will be improved below (see Corollary 4.5):

Corollary 4.3 *If $\xi = nr$, then the equation (1.1) cannot be degenerate.*

Proof. If system (1.1) is degenerate then (4.3) shows that $\xi < nr$. \blacksquare

In case equation (1.1) has the form

$$\dot{x}(t) = \sum_{j=0}^m A_j x(t - h_j), \quad 0 = h_0 < \dots < h_m = r, \quad (4.4)$$

then the condition of the corollary is equivalent to

$$\det A_m \neq 0.$$

The result of Proposition 4.2 has the disadvantage that it refers to all initial functions $\phi \in \mathcal{C}$. In the following theorem we eliminate this shortcoming.

Theorem 4.4 (Kappel [18]) *Let $q \in \mathbb{C}^n \setminus \{0\}$ be given. Then equation (1.1) is degenerate with respect to q if and only if*

$$q^* \Delta^{-1}(\lambda) \text{ is entire.} \tag{4.5}$$

Proof. In view of Proposition 4.2 it is clear that (4.5) is sufficient. In order to prove necessity let us assume that $q^* \Delta^{-1}(\lambda)$ is not entire. Then there exists a $\lambda_0 \in \sigma(L)$ such that λ_0 is a pole also of $q^* \Delta^{-1}(\lambda)$. Choose a function $g(\lambda)$ which is holomorphic at λ_0 and satisfies $g(\lambda_0) \neq 0$. Then $q^* \Delta^{-1}(\lambda)g(\lambda)$ has a pole at λ_0 . Proposition 2.15 implies that

$$x(t) := \operatorname{Res}_{\lambda=\lambda_0} e^{\lambda t} \Delta^{-1}(\lambda)g(\lambda), \quad t \in \mathbb{R},$$

is a generalized eigenfunction corresponding to λ_0 . From

$$q^* x(t) := \operatorname{Res}_{\lambda=\lambda_0} e^{\lambda t} q^* \Delta^{-1}(\lambda)g(\lambda), \quad t \in \mathbb{R},$$

we see that $q^* x(t)$ is not identically zero, because $e^{\lambda t} q^* \Delta^{-1}(\lambda)g(\lambda)$ has a pole at λ_0 . Since $q^* x(t)$ is real analytic it cannot have an accumulation point in \mathbb{R} of zeros. Consequently $q^* x(t)$ cannot be zero for $t \geq t_1$. Thus equation (1.1) is not degenerate. ■

Corollary 4.5 a) *Let $q \in \mathbb{C}^n \setminus \{0\}$ be given. Then equation (1.1) is degenerate with respect to q if and only if there exists a $t_1 > 0$ such that⁷*

$$q^* Y(t) = 0 \quad \text{for } t \geq t_1. \tag{4.6}$$

b) *If $\xi \geq (n - 1)r$ then equation (1.1) is not degenerate.*

Proof. Suppose (4.6) is true. For $\phi \in \mathcal{C}$ we have (see Theorem 1.11)

$$x(t; \phi) = Y(t)\phi(0) + \int_0^t Y(t - \tau)L(\phi_\tau) d\tau, \quad t \geq 0.$$

Using (4.6) we get for $t \geq t_1 + r$

$$q^* x(t; \phi) = \int_{t-t_1}^t q^* Y(t - \tau)L(\phi_\tau) d\tau = 0,$$

because we have $\tau + \theta > t - t_1 - r \geq 0$, $-r \leq \theta \leq 0$, and consequently $\phi_\tau = 0$ for $\tau \in (t - t_1, t]$.

If on the other hand equation (1.1) is degenerate with respect to q , then according to Theorem 4.4 we have that $q^* \Delta^{-1}(\lambda)$ is entire.

⁷ $Y(\cdot)$ denotes the fundamental matrix solution of (1.1).

But $q^*\Delta^{-1}(\lambda)$ is of exponential type and square-integrable on $\lambda = i\omega$, $\omega \in \mathbb{R}$. If $q^*\Delta^{-1}(\lambda) \equiv 0$ then we have $q^*Y(t) = 0$ a.e. on $[0, \infty)$. By continuity of $Y(t)$ we get $q^* = q^*Y(0) = 0$, a contradiction. Therefore we can apply the Paley-Wiener theorem and get $q^*Y(t) = 0$ for $t \geq t_d = \limsup_{\rho \rightarrow \infty} (1/\rho) \ln |q^*\Delta^{-1}(-\rho)|$. The number t_d cannot be replaced by a smaller one. As in the proof for Theorem 3.2 we see that

$$t_d = \limsup_{\rho \rightarrow \infty} \frac{1}{\rho} \ln |q^* \operatorname{adj} \Delta(-\rho)| - \xi.$$

In order to prove b) we assume that $\xi \geq (n - 1)r$. Since

$$\limsup_{\rho \rightarrow \infty} (1/\rho) \ln |q^* \operatorname{adj} \Delta(-\rho)| \leq (n - 1)r,$$

we get the estimate $t_d \leq (n - 1)r - (n - 1)r = 0$. This implies $q^*Y(t) = 0$, $t \geq -r$. Taking $t = 0$ we get $q = 0$, i.e., system (1.1) cannot be degenerate with respect to any $q \in \mathbb{C}^n \setminus \{0\}$. ■

Theorem 4.4 is the starting point for various constructions leading to degenerate functional differential equations of the form (4.5) (see [19]). The next result shows that degeneracy is in fact a property of the generalized eigenspaces of system (1.1).

Proposition 4.6 *System (1.1) is degenerate with respect to $q \in \mathbb{C}^n \setminus \{0\}$ if and only if*

$$q^*\phi(\theta) = 0, \quad -r \leq \theta \leq 0, \quad \text{for all } \phi \in P = \bigoplus_{\lambda \in \sigma(L)} P_\lambda \quad (4.7)$$

or, equivalently,

$$q^*x(t; \phi) \equiv 0 \quad \text{for all } \phi \in P.$$

Proof. Note that $t \rightarrow x(t; \phi)$ is analytic on \mathbb{R} . Therefore condition(4.7) is equivalent to the following: For all $\phi \in P$ there exists a sequence $(t_n)_{n \in \mathbb{N}} \subset \mathbb{R}$ which has an accumulation point on \mathbb{R} and

$$q^*x(t_n; \phi) = 0, \quad n = 1, 2, \dots .$$

Therefore we only have to prove sufficiency of condition (4.7). Assume that equation (1.1) is not degenerate with respect to q . Then there exist a $\psi \in \mathcal{C}$ and a sequence $(t_n)_{n \in \mathbb{N}} \subset [0, \infty)$ with $t_n \rightarrow \infty$ such that

$$q^*x(t_n; \psi) \neq 0, \quad n = 1, 2, \dots .$$

By (4.7) we see that $\psi \notin P$. Furthermore the function $q^*\hat{x}(\lambda; \psi) = q^*\Delta^{-1}(\lambda)p(\lambda; \psi)$ cannot be the Laplace-transform of a function with

bounded support. Assume that $q^*\hat{x}(\lambda; \psi)$ has a pole at λ_0 . It is clear that $\lambda_0 \in \sigma(L)$. As in the proof of Theorem 2.17, c), we conclude that

$$q^* \operatorname{Res}_{\lambda=\lambda_0} e^{\lambda t} \Delta^{-1}(\lambda) p(\lambda; \psi) \neq 0 \quad \text{on } \mathbb{R}.$$

Since this function is real analytic it cannot have an accumulation point of zeros in \mathbb{R} . Therefore $\psi(\theta) = \operatorname{Res}_{\lambda=\lambda_0} e^{\lambda \theta} \Delta^{-1}(\lambda) p(\lambda; \psi)$, $-r \leq \theta \leq 0$, is a function in P_{λ_0} such that $q^*x(\tilde{t}_n; \psi) \neq 0$, $n = 1, 2, \dots$, for a sequence $(\tilde{t}_n)_{n \in \mathbb{N}} \subset [0, \infty)$ with $\tilde{t}_n \rightarrow \infty$, which is a contradiction to (4.7). Thus we have shown that $q^*\hat{x}(t; \phi) = q^*\Delta^{-1}(\lambda)p(\lambda; \phi)$ is entire. From Proposition 4.2 we conclude that system (1.1) is degenerate with respect to q . ■

Proposition 4.6 and the characterization of small solutions as given in Theorem 3.2 show that the degeneracy time depends on the small solutions only.

Proposition 4.7 *Let system (1.1) be degenerate with respect to $q \in \mathbb{C}^n \setminus \{0\}$ and denote by t_d the degeneracy time of system (1.1). Then the following is true:*

a) *We have*

$$0 < t_d \leq \limsup_{\rho \rightarrow \infty} \frac{1}{\rho} \ln |q^* \operatorname{adj} \Delta(-\rho)| - \xi.$$

b) *If $\det \Delta(\lambda)$ is a polynomial in λ only, then*

$$0 < t_d \leq \limsup_{\rho \rightarrow \infty} \frac{1}{\rho} \ln |q^* \operatorname{adj} \Delta(-\rho)|.$$

Proof. Let first $\phi \in \overline{P} \oplus Q$ and set $\phi = \phi_P + \phi_Q$, $\phi_P \in \overline{P}$, $\phi_Q \in Q$. Then we have $q^*x(t; \phi_P) = 0$ for $t \geq 0$, because $q^*x(t; \psi) \equiv 0$ for all $\psi \in P$. Consequently

$$q^*x(t; \phi) = q^*x(t; \phi_Q) \quad \text{for } t \geq -r.$$

We investigate the function $y(t) = q^*x(t - r; \phi_Q)$, $t \geq 0$. As in the proof of Theorem 3.2 we see that

$$q^*x(t; \phi_Q) = 0 \quad \text{for } t \geq \limsup_{\rho \rightarrow \infty} \frac{1}{\rho} \ln |q^* \operatorname{adj} \Delta(-\rho)| - \xi.$$

Next choose $\phi \in \mathcal{C} = \overline{\overline{P} \oplus Q}$. Then $\phi = \lim_{k \rightarrow \infty} (\phi_k + \psi_k)$, where $\phi_k \in \overline{P}$, $\psi_k \in Q$, $k = 1, 2, \dots$. Since $q^*x(t; \phi_k + \psi_k) = 0$ for $t \geq \limsup_{\rho \rightarrow \infty} (1/\rho) \ln |q^* \operatorname{adj} \Delta(-\rho)| - \xi$, $k = 1, 2, \dots$, we get also

$$q^*x(t; \phi) = 0 \quad \text{for } t \geq \limsup_{\rho \rightarrow \infty} (1/\rho) \ln |q^* \operatorname{adj} \Delta(-\rho)| - \xi.$$

It is obvious that $\xi = \limsup_{\rho \rightarrow \infty} (1/\rho) \ln |\det \Delta(-\rho)| = 0$ in case that $\det \Delta(\lambda)$ is a polynomial in λ only. ■

4.2 A necessary condition for degeneracy

In this section we first prove a necessary condition for degeneracy of delay equations in terms of a specific factorization of the characteristic function. Then we explain the meaning of this necessary condition for the structure of the degenerate delay equation. We can only prove these results for difference-differential equations with a finite number of commensurate delays. We start with difference-differential equations with a finite number of delays:

$$\dot{x}(t) = \sum_{j=0}^m A_j x(t - h_j), \quad 0 = h_0 < \dots < h_m = r. \tag{4.8}$$

View \mathbb{R} as an (infinite dimensional) vector space of the field \mathbb{Q} of rational numbers and denote by K the positive cone generated by⁸ h_1, \dots, h_m . Let $\tilde{r}_1, \dots, \tilde{r}_k \in K$ be linearly independent elements which also generate K . Then we have

$$h_j = \sum_{i=1}^k \alpha_{j,i} \tilde{r}_i, \quad j = 1, \dots, m,$$

where $\alpha_{j,i} \in \mathbb{Q}$, $\alpha_{j,i} \geq 0$, $j = 1, \dots, m$, $i = 1, \dots, k$. Denote by α the least common multiple of the denominators of the $\alpha_{j,i}$'s. Then also the elements $r_i = \alpha \tilde{r}_i$, $i = 1, \dots, k$, generate K and are linearly independent. We have

$$h_j = \sum_{i=1}^k \beta_{j,i} r_i, \quad j = 1, \dots, m,$$

where now $\beta_{j,i} \in \mathbb{Z}$, $j = 1, \dots, m$, $i = 1, \dots, k$. We set $\beta_{0,i} = 0$, $i = 1, \dots, k$. Equation (4.8) can now be written as

$$\dot{x}(t) = \sum_{j=0}^m A_j x\left(t - \sum_{i=1}^k \beta_{j,i} r_i\right). \tag{4.9}$$

In case $k \geq 2$ we call the delays non-commensurate. If $k = 1$ the delays are commensurate and (4.9) has the form

$$\dot{x}(t) = \sum_{j=0}^m A_j x(t - \ell_j h) \tag{4.10}$$

⁸ $K = \{\alpha_1 h_1 + \dots + \alpha_m h_m \mid \alpha_i \in \mathbb{Q} \text{ and } \alpha_i \geq 0, i = 1, \dots, m\}$.

with $0 = \ell_0 < \ell_1 < \dots < \ell_m$, $\ell_i \in \mathbb{N}$, $i = 1, \dots, m$. It is not difficult to see that

$$\begin{aligned} \Delta(\lambda) &= \lambda I - \sum_{j=0}^m A_j \exp\left(-\lambda \sum_{i=1}^k \beta_{j,i} r_i\right) \\ &= \lambda I - \sum_{j=0}^m A_j (e^{-\lambda r_1})^{\beta_{j,1}} \dots (e^{-\lambda r_k})^{\beta_{j,k}} \\ &= \lambda I - \sum_{j=0}^m A_j \mu_1^{\beta_{j,1}} \dots \mu_k^{\beta_{j,k}}, \end{aligned}$$

where $\mu_i = e^{-\lambda r_i}$, $i = 1, \dots, k$. We define $A \in \mathbb{C}^{n \times n}[\mu_1, \dots, \mu_k]$ by

$$A(\mu_1, \dots, \mu_k) = \sum_{j=0}^m A_j \mu_1^{\beta_{j,1}} \dots \mu_k^{\beta_{j,k}}.$$

Then we have

$$\Delta(\lambda) = \lambda I - A(e^{-\lambda r_1}, \dots, e^{-\lambda r_k})$$

and

$$\det \Delta(\lambda) = \chi_A(\lambda, e^{-\lambda r_1}, \dots, e^{-\lambda r_k}).$$

In case of system (4.10) we have with $\mu = e^{-\lambda h}$

$$A(\mu) = \sum_{j=0}^m A_j \mu^{\ell_j},$$

$$\Delta(\lambda) = \lambda I - A(e^{-\lambda h}) \text{ and}$$

$$\det \Delta(\lambda) = \chi_A(\lambda, e^{-\lambda h}).$$

In the following we shall treat $\lambda, \mu_1, \dots, \mu_k$ resp. λ and μ as indeterminates. However, occasionally we have to remember that $\mu_i = e^{-\lambda r_i}$, $i = 1, \dots, k$ resp. $\mu = e^{-\lambda h}$. Our next goal is to prove Zverkin's necessary condition for degeneracy of systems of the form (4.10). We introduce the notation

$$\begin{aligned} p_0(\lambda, \mu) &= \chi_A(\lambda, \mu), \\ q^* \operatorname{adj}(\lambda I - A(\mu))^{-1} &= (p_1(\lambda, \mu), \dots, p_n(\lambda, \mu)). \end{aligned}$$

This implies

$$q^* (\lambda I - A(\mu))^{-1} = \left(\frac{p_1(\lambda, \mu)}{p_0(\lambda, \mu)}, \dots, \frac{p_n(\lambda, \mu)}{p_0(\lambda, \mu)} \right).$$

We have the following claim:

If system (4.10) is degenerate with respect to q , then $p_j(\lambda, \mu) \not\equiv 0$ for at least one $j \in \{1, \dots, n\}$. (4.11)

In order to prove the claim suppose that $p_1 \equiv \dots \equiv p_n \equiv 0$. This implies $q^*(\lambda I - A(\mu))^{-1} \equiv 0$ and – taking $\mu = e^{-\lambda h}$ –

$$q^* \Delta^{-1}(\lambda) \equiv 0 \quad \text{in } \mathbb{C}.$$

This implies $q = 0$, a contradiction.

We shall need the following lemma on greatest common divisors of polynomials in $\mathbb{C}[\lambda, \mu]$.

Lemma 4.8 *Let $p, q \in \mathbb{C}[\lambda, \mu] \setminus \{0\}$ and let d be a greatest common divisor. We assume that*

- (i) $q(\lambda, \mu) = \lambda^\kappa + \tilde{q}(\lambda, \mu)$ with λ -degree $\tilde{q} < \kappa$,
- (ii) $\partial p(\lambda, \mu) / \partial \mu \not\equiv 0$ and
- (iii) $\frac{p(\lambda, \mu)}{q(\lambda, \mu)}$ is entire.

Then we have $\partial d / \partial \mu \not\equiv 0$, i.e., d really depends on μ .

Proof. Because of assumption (i) the function $q(\lambda, e^{-\lambda h})$ has infinitely many different zeros $\lambda_1, \lambda_2, \dots$ (see [2]). By assumption (ii) also $p(\lambda, e^{-\lambda h})$ has at least the zeros $\lambda_1, \lambda_2, \dots$. From Lemma D.1 with $m = 2$ we see that there exist $R_1, R_2 \in \mathbb{C}[\lambda, \mu]$ and a $w \in \mathbb{C}[\lambda]$ such that

$$p(\lambda, \mu)R_1(\lambda, \mu) + q(\lambda, \mu)R_2(\lambda, \mu) = w(\lambda)d(\lambda, \mu).$$

If d does not depend on μ , $d = d(\lambda)$, then the last equation implies

$$w(\lambda_\nu)d(\lambda_\nu) = 0, \quad \nu = 1, 2, \dots,$$

which is not possible. Note that $d \not\equiv 0$ because $p \not\equiv 0$ and $q \not\equiv 0$. Then d must depend on μ . ■

Theorem 4.9 (Zverkin [32]) *Assume that system (4.10) is degenerate. Then there exists a monic polynomial $s_0 \in \mathbb{C}[\lambda]$ with degree $s_0 \geq 1$ such that*

$$\det(\lambda I - A(\mu)) = s_0(\lambda)s_1(\lambda, \mu)$$

with some monic polynomial $s_1 \in \mathbb{C}[\lambda, \mu]$. Consequently we also have

$$\Delta(\lambda) = s_0(\lambda)s_1(\lambda, e^{-\lambda h}).$$

Proof. We follow the algebraic proof given in [18]. If $p_0(\lambda\mu) = \det(\lambda I - A(\mu))$ does not depend on μ , then there is nothing to be proved. Assume that $\partial p_0/\partial\mu \neq 0$. According to the claim (4.11) we have $p_{j_0} \neq 0$ for some $j_0 \in \{1, \dots, n\}$. Since, by Theorem 4.4, $q^*\Delta^{-1}(\lambda)$ is entire for some $q \in \mathbb{C}^n \setminus \{0\}$, we can apply Lemma 4.8 and get

$$p_0(\lambda, \mu) = d(\lambda, \mu)s_0(\lambda, \mu) \text{ and } p_{j_0}(\lambda, \mu) = d(\lambda, \mu)s_{j_0}(\lambda, \mu),$$

where d is a greatest common divisor of p_0 and p_{j_0} . Moreover we have $\partial d/\partial\mu \neq 0$.

Since $p_{j_0}(\lambda, e^{-\lambda h})/p_0(\lambda, e^{-\lambda h}) = s_{j_0}(\lambda, e^{-\lambda h})/s_0(\lambda, e^{-\lambda h})$ is entire, Lemma 4.8 implies that in case $\partial s_0/\partial\mu \neq 0$ there exists a greatest common divisor \tilde{d} of s_{j_0} and s_0 with $\partial\tilde{d}/\partial\mu \neq 0$. But then $d\tilde{d}$ would be a common divisor of p_{j_0} and p_0 , a contradiction with the definition of d because \tilde{d} is non-constant. Thus we have $\partial s_0/\partial\mu \equiv 0$, i.e., $s_0 \in \mathbb{C}[\lambda]$.

■

4.3 Coordinate transformations with delays

Theorem D.5 states that corresponding to a factorization of the characteristic polynomial $\chi_A(\lambda, \mu)$ of a matrix $A(\mu) \in \mathbb{C}^{n \times n}[\mu]$ we can transform A by a similarity transform with a unimodular matrix to a block-triangular form. In this section we want to investigate the meaning of this transformation for the delay equation (4.10) corresponding to A .

Definition 4.10 Let $S(\mu) = S_0 + \dots + S_{k'}\mu^{k'}$ be a unimodular matrix in $\mathbb{C}^{n \times n}[\mu]$ with inverse $S^{-1}(\mu) = T_0 + \dots + T_k\mu^k$. For $x, y \in C(-\infty, \infty; \mathbb{C}^n)$ we define the linear mappings $\pi, \pi^{-1} : C(-\infty, \infty; \mathbb{C}^n) \rightarrow C(-\infty, \infty; \mathbb{C}^n)$ by

$$\begin{aligned} (\pi x)(t) &= T_0 + \dots + T_k x(t - kh) \text{ and} \\ (\pi^{-1}y)(t) &= S_0 + \dots + S_{k'} y(t - k'h), \quad t \in \mathbb{R}. \end{aligned} \tag{4.12}$$

If we define the shift $\sigma : C(-\infty, \infty; \mathbb{C}^n) \rightarrow C(-\infty, \infty; \mathbb{C}^n)$ by $(\sigma x)(t) = x(t - h)$, $t \in \mathbb{R}$, then (4.12) can also be written as

$$\pi x = S^{-1}(\sigma)x, \quad \pi^{-1}y = S(\sigma)y, \quad x, y \in C(-\infty, \infty; \mathbb{C}^n).$$

From this it is also clear that π and π^{-1} are indeed inverses of each other.

Let $A, \tilde{A} \in \mathbb{C}^{n \times n}[\mu]$ be given with

$$\tilde{A} = S^{-1}AS,$$

where $S \in \mathbb{C}^{n \times n}[\mu]$ is unimodular and let π, π^{-1} be the mappings defined by (4.12) Furthermore let

$$\dot{x}(t) = (A(\sigma)x)(t) =: L(x_t) \tag{4.13}$$

and

$$\dot{y}(t) = (\tilde{A}(\boldsymbol{\sigma})y)(t) =: \tilde{L}(y_t) \quad (4.14)$$

be the delay systems corresponding to A resp. \tilde{A} . Then we have the following result:

Proposition 4.11 a) *If $x \in C(-\infty, \infty; \mathbb{C}^n)$ solves (4.13) for $t \geq t_0$, then $y = \pi x$ solves (4.14) at least for $t \geq t_0 + kh$.*

b) *Let \mathcal{L}_1 resp. \mathcal{L}_2 denote the subspaces of $C(-\infty, \infty; \mathbb{C}^n)$ consisting of all x resp. y which are solutions of (4.13) resp. (4.14) on \mathbb{R} . Then π maps \mathcal{L}_1 one-to-one onto \mathcal{L}_2 .*

Proof. a) let $x \in C(-\infty, \infty; \mathbb{C}^n)$ be a solution of (4.13) for $t \geq t_0$, i.e., x is differentiable for $t \geq t_0$ and

$$\dot{x}(t) = (A(\boldsymbol{\sigma})x)(t), \quad t \geq t_0.$$

Set $y(t) = T_0x(t) + \dots + T_kx(t - kh)$. Then it is easy to see that y is differentiable at least for $t \geq t_0 + kh$ and

$$\begin{aligned} \dot{y}(t) &= (S^{-1}(\boldsymbol{\sigma})\dot{x})(t) = (S^{-1}(\boldsymbol{\sigma})A(\boldsymbol{\sigma})x)(t) \\ &= (S^{-1}(\boldsymbol{\sigma})A(\boldsymbol{\sigma})S(\boldsymbol{\sigma})y)(t) = (\tilde{A}(\boldsymbol{\sigma})y)(t), \quad t \geq t_0 + kh. \end{aligned}$$

b) In view of part a) of the theorem it is clear that $\pi\mathcal{L}_1 \subset \mathcal{L}_2$. For $y \in \mathcal{L}_2$ we have $x = \pi^{-1}y \in \mathcal{L}_1$ and $\pi x = y$, i.e., $\pi\mathcal{L}_1 = \mathcal{L}_2$. ■

In order to give more detailed information on the transformations π and π^{-1} we introduce some notation:

$$\tilde{\Delta}(\lambda) := \lambda I - \tilde{A}(e^{-\lambda h}) = S^{-1}(e^{-\lambda h})\Delta(\lambda)S(e^{-\lambda h}),$$

\tilde{P}_{λ_0} ... generalized eigenspace of equation (4.14) corresponding to λ_0 ,

$$\hat{\Delta}_{k+1}(\lambda) = \begin{pmatrix} \tilde{\Delta}(\lambda) & \frac{1}{1!}\tilde{\Delta}'(\lambda) & \dots & \frac{1}{k!}\tilde{\Delta}^{(k)}(\lambda) \\ 0 & \ddots & \ddots & \vdots \\ \vdots & \ddots & \ddots & \frac{1}{1!}\tilde{\Delta}'(\lambda) \\ 0 & \dots & 0 & \tilde{\Delta}(\lambda) \end{pmatrix} \in \mathbb{C}^{nk \times nk},$$

$$\hat{c}_{k+1} = \text{col}(c_0, \dots, c_k), \quad c_j \in \mathbb{C}^n, \quad j = 0, \dots, k.$$

Lemma 4.12 *Let $\lambda_0 \in \sigma(L) = \sigma(\tilde{L})$ be given and let, for some $a \in \mathbb{C}^n$,*

$$x(t) = e^{\lambda_0 t} \frac{t^j}{j!} a, \quad t \in \mathbb{R}.$$

Then we have

$$(\pi x)(t) = e^{\lambda_0 t} \sum_{\kappa=0}^j \frac{t^\kappa}{\kappa!} \cdot \frac{1}{(j-\kappa)!} \frac{d^{j-\kappa}}{d\lambda^{j-\kappa}} S^{-1}(e^{-\lambda_0 h}) a, \quad t \in \mathbb{R}.$$

Proof. Observing

$$\binom{j}{\kappa} = \frac{j!}{\kappa!(j-\kappa)!}$$

the definition of π implies:

$$\begin{aligned} (\pi x)(t) &= \sum_{\ell=0}^k \frac{1}{j!} (t-\ell h)^j e^{\lambda_0(t-\ell h)} T_{\ell} a \\ &= e^{\lambda_0 t} \sum_{\ell=0}^k \frac{1}{j!} e^{-\lambda_0 \ell h} T_{\ell} a \sum_{\kappa=0}^j \binom{j}{\kappa} t^{\kappa} (-\ell h)^{j-\kappa} \\ &= e^{\lambda_0 t} \sum_{\kappa=0}^j \frac{t^{\kappa}}{\kappa!} \sum_{\ell=0}^k \frac{1}{(j-\kappa)!} e^{-\lambda_0 \ell h} (-\ell h)^{j-\kappa} T_{\ell} a \\ &= e^{\lambda_0 t} \sum_{\kappa=0}^j \frac{t-\kappa}{\kappa!} \frac{1}{(j-\kappa)!} \frac{d^{j-\kappa}}{d\lambda^{j-\kappa}} S^{-1}(e^{-\lambda_0 h}) a, \quad t \in \mathbb{R}. \end{aligned}$$

■

Lemma 4.13 Choose $\lambda_0 \in \sigma(L) = \sigma(\tilde{L})$ and define the subspaces

$$\begin{aligned} X_k(\lambda_0) &= \left\{ e^{\lambda_0 t} \sum_{j=0}^{k-1} \frac{t^j}{j!} b_j \mid \tilde{\Delta}_k(\lambda_0) \tilde{b}_k = 0 \right\} \\ \tilde{X}_k(\lambda_0) &= \left\{ e^{\lambda_0 t} \sum_{j=0}^{k-1} \frac{t^j}{j!} c_j \mid \hat{\Delta}_k(\lambda_0) \hat{c}_k = 0 \right\}, \quad k = 1, 2, \dots \end{aligned}$$

Then π maps $X_k(\lambda_0)$ one-to-one onto $\tilde{X}_k(\lambda_0)$, $k = 1, 2, \dots$

Proof. Let $x(\cdot) \in X_k(\lambda_0)$ be given, i.e.,

$$x(t) = e^{\lambda_0 t} \sum_{j=0}^{k-1} \frac{t^j}{j!} b_j, \quad \tilde{\Delta}(\lambda_0) \tilde{b}_k = 0.$$

From Lemma 4.12 we get

$$\begin{aligned} (\pi x)(t) &= e^{\lambda_0 t} \sum_{j=0}^{k-1} \sum_{\kappa=0}^j \frac{t^{\kappa}}{\kappa!} \frac{1}{(j-\kappa)!} \frac{d^{j-\kappa}}{d\lambda^{j-\kappa}} S^{-1}(e^{-\lambda_0 h}) b_j \\ &= e^{\lambda_0 t} \sum_{\kappa=0}^{k-1} \frac{t^{\kappa}}{\kappa!} \sum_{j=\kappa}^{k-1} \frac{1}{(j-\kappa)!} \frac{d^{j-\kappa}}{d\lambda^{j-\kappa}} S^{-1}(e^{-\lambda_0 h}) b_j. \end{aligned}$$

We set

$$c_\kappa = \sum_{j=\kappa}^{k-1} \frac{1}{(j-\kappa)!} \frac{d^{j-\kappa}}{d\lambda^{j-\kappa}} S^{-1}(e^{-\lambda_0 h}) b_j, \quad \kappa = 0, \dots, k-1.$$

In order to prove that $\pi x \in \tilde{X}_k(\lambda_0)$ we have to show that $\hat{\Delta}_k(\lambda_0)\hat{c}_k = 0$. It is easy to see that $\hat{c}_k = \tilde{T}_k(\lambda_0)\tilde{b}_k$, where the matrix $\tilde{T}_k(\lambda_0)$ is defined by

$$\tilde{T}_k(\lambda_0) = \begin{pmatrix} S^{-1}(e^{-\lambda_0 h}) & \cdots & \cdots & \frac{1}{(k-1)!} \frac{d^{k-1}}{d\lambda^{k-1}} S^{-1}(e^{-\lambda_0 h}) \\ 0 & \ddots & & \vdots \\ \vdots & \ddots & \ddots & \vdots \\ 0 & \cdots & 0 & S^{-1}(e^{-\lambda_0 h}) \end{pmatrix}. \quad (4.15)$$

Lemma 2.6 applied to

$$\Delta(\lambda) = S^{-1}(e^{-\lambda_0 h})\Delta(\lambda)S(e^{-\lambda_0 h})$$

implies (see (2.3) for the definition of $\tilde{S}_k(\lambda_0)$)

$$\hat{\Delta}_k(\lambda_0) = \tilde{T}_k(\lambda_0)\tilde{\Delta}_k(\lambda_0)\tilde{S}_k(\lambda_0). \quad (4.16)$$

From $\tilde{\Delta}_k(\lambda_0)\tilde{b}_k = 0$ and (4.16) we get

$$\hat{\Delta}_k(\lambda_0)\hat{c}_k = \tilde{T}_k(\lambda_0)\tilde{\Delta}_k(\lambda_0)\tilde{S}_k(\lambda_0)\tilde{T}_k(\lambda_0)\tilde{b}_k.$$

Lemma 2.6 applied to $S(e^{-\lambda h})S^{-1}(e^{-\lambda h}) \equiv I$, which is satisfied in a neighborhood of λ_0 , gives $\tilde{S}_k(\lambda_0)\tilde{T}_k(\lambda_0) = I \in \mathbb{C}^{nk \times nk}$, so that

$$\hat{\Delta}_k(\lambda_0)\hat{c}_k = \tilde{T}_k(\lambda_0)\tilde{\Delta}_k(\lambda_0)\tilde{b}_k = 0.$$

Thus we have shown that $\pi X_k(\lambda_0) \subset \tilde{X}_k(\lambda_0)$. Taking π^{-1} instead of π we obtain $\pi^{-1}\tilde{X}_k(\lambda_0) \subset X_k(\lambda_0)$. Consequently we have $\tilde{X}_k(\lambda_0) = \pi(\pi^{-1}\tilde{X}_k(\lambda_0)) \subset \pi X_k(\lambda_0) \subset \tilde{X}_k(\lambda_0)$, i.e., $\pi X_k(\lambda_0) = \tilde{X}_k(\lambda_0)$. ■

Remark. Let $[-r, 0]$ resp. $[-\tilde{r}, 0]$ denote the delay interval for system (4.13) resp. (4.14). By Corollary 2.11 we see that $\ker(\lambda_0 I - \mathcal{A}) = \{x|_{[-r, 0]} \mid x \in X_k(\lambda_0)\}$ and $\ker(\lambda_0 I - \tilde{\mathcal{A}}) = \{y|_{[-\tilde{r}, 0]} \mid y \in \tilde{X}_k(\lambda_0)\}$. We also have seen in Section 7 that

$$P_{\lambda_0} = \ker(\lambda_0 I - \mathcal{A})^k, \quad \tilde{P}_{\lambda_0} = \ker(\lambda_0 I - \tilde{\mathcal{A}})^k, \quad k = \kappa_0, \kappa_0 + 1, \dots$$

If we agree to extend functions $\phi \in P_{\lambda_0}$, $\phi(\theta) = e^{\lambda_0 \theta} \sum_{j=0}^{\kappa_0-1} (\theta^j / j!) b_j$, $-r \leq \theta \leq 0$, with $\tilde{\Delta}_{\kappa_0}(\lambda_0)\tilde{b}_{\kappa_0} = 0$, to all of \mathbb{R} by setting $x(t; \phi) =$

$e^{\lambda_0 t} \sum_{j=0}^{\kappa_0-1} (t^j/j!)b_j$, then we can define a mapping $\bar{\pi} : P \rightarrow \tilde{P}$, where $P = \bigoplus_{\lambda_0 \in \sigma(L)} P_{\lambda_0}$, $\tilde{P} = \bigoplus_{\lambda_0 \in \sigma(L)} \tilde{P}_{\lambda_0}$, as follows:

$$\bar{\pi}\phi = \pi x(\cdot; \phi) |_{[-\tilde{\tau}, 0]} .$$

Then it is clear that $\bar{\pi}$ maps P one-to-one onto \tilde{P} . The result of Lemma 4.13 implies that $\bar{\pi}$ also maps $\ker(\lambda_0 I - A)^k$ one-to-one onto $\ker(\lambda_0 I - \tilde{A})^k$, $k = 1, 2, \dots$.

The next result states that a coordinate transform with delays given by a unimodular matrix does not change the structure of the generalized eigenspaces as given in Theorem 2.12.

Theorem 4.14 *Let $\tilde{A}(\mu) = S^{-1}(\mu)A(\mu)S(\mu)$ with a unimodular matrix $S \in \mathbb{C}^{n \times n}[\mu]$. For $\lambda_0 \in \sigma(L) = \sigma(\tilde{L})$ denote by P_{λ_0} resp. \tilde{P}_{λ_0} the generalized eigenspace of system (4.13) resp. of (4.14).*

Then there exist uniquely determined numbers $\ell \geq 1$, d_ρ , m_ρ with $m_\rho > 0$, $\rho = 1, \dots, \ell$, satisfying $0 \leq d_1 < \dots < d_\ell$ such that

$$P_{\lambda_0} = \bigoplus_{\rho=1}^{\ell} \bigoplus_{j=1}^{m_\rho} Z_{\rho,j} \text{ and } \tilde{P}_{\lambda_0} = \bigoplus_{\rho=1}^{\ell} \bigoplus_{j=1}^{m_\rho} \tilde{Z}_{\rho,j}, \tag{4.17}$$

where the subspaces $Z_{\rho,j}$ of P_{λ_0} resp. $\tilde{Z}_{\rho,j}$ of \tilde{P}_{λ_0} satisfy

- (i) $\dim Z_{\rho,j} = \dim \tilde{Z}_{\rho,j} = d_\rho$, $j = 1, \dots, m_\rho$, $\rho = 1, \dots, \ell$,
- (ii) $Z_{\rho,j}$ is \mathcal{A} -cyclic and $\tilde{Z}_{\rho,j}$ is $\tilde{\mathcal{A}}$ -cyclic, $j = 1, \dots, m_\rho$, $\rho = 1, \dots, \ell$.

Moreover, we can take

$$\tilde{Z}_{\rho,j} = \bar{\pi}Z_{\rho,j}, \quad j = 1, \dots, m_\rho, \quad \rho = 1, \dots, \ell.$$

Proof. From Lemma 2.5 and the proof for part (iv) of Theorem 2.4 we see that the numbers ℓ , m_ρ , d_ρ , $\rho = 1, \dots, \ell$, which exist according to Theorem 2.4 for $\Delta(\lambda) = \lambda I - A(e^{-\lambda h})$ resp. for $\tilde{\Delta}(\lambda) = \lambda I - \tilde{A}(e^{-\lambda h})$ at λ_0 are the same. This establishes the decomposition (4.17).

Using the facts that the action of \mathcal{A} and of $\tilde{\mathcal{A}}$ is differentiation, that π and $\bar{\pi}$ commute with differentiation and that $\dot{x}(\cdot; \phi) = x(\cdot; \dot{\phi})$ for $\phi \in P_{\lambda_0}$ (see Theorem 1.9) we get, for $\phi \in P_{\lambda_0}$,

$$\begin{aligned} \bar{\pi}\mathcal{A}\phi &= \bar{\pi}\dot{\phi} = (\pi x(\cdot; \dot{\phi})) |_{[-\tilde{\tau}, 0]} = (\pi \dot{x}(\cdot; \phi)) |_{[\tilde{\tau}, 0]} \\ &= \left(\frac{d}{dt} \pi x(\cdot; \phi) \right) |_{[-\tilde{\tau}, 0]} = \frac{d}{dt} \left(\pi x(\cdot; \phi) |_{[-\tilde{\tau}, 0]} \right) = \frac{d}{dt} \bar{\pi}\phi = \tilde{\mathcal{A}}\bar{\pi}\phi. \end{aligned}$$

Set $Z = Z_{\rho,j}$, $k = \dim Z_{\rho,j} = d_\rho$ and choose a basis $\phi_0, \dots, \phi_{k-1}$ of Z satisfying

$$\begin{aligned} \mathcal{A}\phi_0 &= \lambda_0\phi_0, \\ \mathcal{A}\phi_j &= \lambda_0\phi_j - \phi_{j-1}, \quad j = 1, \dots, k-1, \end{aligned}$$

(see the paragraph before Theorem 2.12). For

$$\tilde{\phi}_j = \bar{\pi}\phi_j, \quad j = 0, \dots, k-1,$$

we get $\tilde{\mathcal{A}}\tilde{\phi}_0 = \tilde{\mathcal{A}}\bar{\pi}\phi_0 = \bar{\pi}\mathcal{A}\phi_0 = \lambda_0\bar{\pi}\phi_0 = \lambda_0\tilde{\phi}_0$ and $\tilde{\mathcal{A}}\tilde{\phi}_j = \tilde{\mathcal{A}}\bar{\pi}\phi_j = \bar{\pi}\mathcal{A}\phi_j = \bar{\pi}(\lambda_0\phi_j - \phi_{j-1}) = \lambda_0\tilde{\phi}_j - \tilde{\phi}_{j-1}$, $j = 1, \dots, k-1$, i.e., $\tilde{Z} = \bar{\pi}Z$ is also cyclic with $\dim \tilde{Z} = \dim Z = k$. ■

Remark. It is easy to see (but tedious to formulate) that all results presented in this section hold also with appropriate notational changes for the case of non-commensurate delays.

4.4 The structure of degenerate systems with commensurate delays

The necessary condition for degeneracy of systems with commensurate delays given in Zverkin's theorem together with the triangularization theorem for polynomial matrices over the ring $\mathbb{C}[\mu]$ (see Theorem D.5) suggest that degenerate systems with commensurate delays can be transformed to a system which consists of two coupled subsystems, where one of these subsystems is degenerate and has a polynomial of λ only as its characteristic function. Loosely speaking, degenerate systems with commensurate delays are those which are similar (under transformations with delays) to ordinary differential equations. The precise statement is the following:

Theorem 4.15 *Assume that system (4.13) is degenerate with respect to $q \in \mathbb{C}^n \setminus \{0\}$ and that in the factorization*

$$\chi_A(\lambda, \mu) = p_1(\lambda, \mu)p_2(\lambda)$$

with monic and relatively prime polynomials the polynomial p_1 does not contain a non-trivial factor independent of μ . Then there exists a unimodular matrix $S \in \mathbb{C}^{n \times n}[\mu]$ such that

$$\tilde{A} = S^{-1}AS = \begin{pmatrix} A_1 & A_{1,2} \\ 0 & A_2 \end{pmatrix}$$

with $A_1 \in \mathbb{C}^{n_1 \times n_1}[\mu]$, $A_2 \in \mathbb{C}^{n_2 \times n_2}[\mu]$, where $n_1 = \lambda$ -degree p_1 , $n_2 = \text{degree } p_2 > 0$, and

$$\chi_{A_1} = p_1, \quad \chi_{A_2} = p_2.$$

Moreover, the delay system corresponding to $A_2(\mu)$ is degenerate with respect to a $q_2 \in \mathbb{C}^{n_2} \setminus \{0\}$, whereas the delay system corresponding to $A_1(\mu)$ is not degenerate.

Proof. Without restriction of generality we can assume that $q = \text{col}(0, q_2)$ with $q_2 = \text{col}(1, 0, \dots, 0) \in \mathbb{C}^{n_2}$. Otherwise we choose an invertible matrix $T \in \mathbb{C}^{n \times n}$ such that $q^*T = (0, q_2^*)$ and replace $A(\mu)$ by $T^{-1}A(\mu)T$.

By Zverkin's result it is clear that $n_2 > 0$. According to Theorem D.5 there exists a unimodular matrix $S \in \mathbb{C}^{n \times n}[\mu]$ such that $\tilde{A}(\mu)$ has the properties given in the theorem. Since $p_1(\lambda, \mu)$ does not contain a non-trivial factor which depends in λ only, the delay system corresponding to $A_1(\mu)$ cannot be degenerate.

It remains to prove that we can choose S such that the delay system corresponding to $A_2(\mu)$ is degenerate with respect to q_2 . According to Theorem 4.4 the function $q^*\Delta^{-1}(\lambda)$ is entire. This implies that also

$$q^*S(e^{-\lambda h})S^{-1}(e^{-\lambda h})\Delta^{-1}(\lambda)S(e^{-\lambda h}) = q^*S(e^{-\lambda h})\tilde{\Delta}^{-1}(\lambda) \quad (4.18)$$

is entire. We set $S = (U, V)$ where $U \in \mathbb{C}^{n \times n_1}[\mu]$ and $V \in \mathbb{C}^{n \times n_2}[\mu]$. The matrix $(\lambda I - \tilde{A}(\mu))^{-1}$ is given by

$$(\lambda I - \tilde{A}(\mu))^{-1} = \begin{pmatrix} (\lambda I - A_1(\mu))^{-1} & B_{1,2}(\lambda, \mu) \\ 0 & (\lambda I - A_2(\mu))^{-1} \end{pmatrix}.$$

Consequently we get

$$q^*S(e^{-\lambda h})\tilde{\Delta}^{-1}(\lambda) = q^*(W_1(\lambda), W_2(\lambda)),$$

where

$$\begin{aligned} W_1(\lambda) &= U(e^{-\lambda h})(\lambda I - A_1(e^{-\lambda h}))^{-1}, \\ W_2(\lambda) &= U(e^{-\lambda h})B_{1,2}(\lambda, e^{-\lambda h}) + V(e^{-\lambda h})(\lambda I - A_2(e^{-\lambda h}))^{-1}. \end{aligned}$$

Since the matrix (4.18) is entire, we see that also $q^*W_1(\lambda)$ is entire. Suppose that $q^*U(\mu) \not\equiv 0$. Then we see that at least one $r_{j_0}(\lambda, \mu)$ in the representation

$$q^*U(\mu)(\lambda I - A_1(\mu))^{-1} = \frac{1}{p_1(\lambda, \mu)}(r_1(\lambda, \mu), \dots, r_{n_1}(\lambda, \mu))$$

is not identically zero. As in the proof of Theorem 4.9 we see that

$$\begin{aligned} r_{j_0}(\lambda, \mu) &= s_{j_0}(\lambda, \mu)d(\lambda, \mu), \\ p_1(\lambda, \mu) &= s_0(\lambda)d(\lambda, \mu). \end{aligned}$$

From λ -degree $r_{j_0} < \lambda$ -degree p_1 we conclude that $\text{degree } s_0 > 0$. But then $p_1(\lambda, \mu)$ has a non-trivial factor depending on λ only, which contradicts the assumption made on p_1 . This proves that

$$q^*U(e^{-\lambda h}) \equiv 0.$$

Consequently we get

$$q^*S(e^{-\lambda h})\tilde{\Delta}^{-1}(\lambda) = \left(0, q^*V(e^{-\lambda h})(\lambda I - A_2(e^{-\lambda h}))^{-1}\right). \quad (4.19)$$

We have $q^*V(e^{-\lambda h}) \not\equiv 0$. Otherwise we would have $q^*S(e^{-\lambda h})\tilde{\Delta}^{-1}(\lambda) \equiv 0$, which implies $q = 0$, a contradiction.

Let $v(\mu)$ be the $(n_1 + 1)$ -st row of $V(\mu)$, i.e., $q^*V(\mu) = v(\mu)$. This and $q^*U(\mu) \equiv 0$ imply that $(0, \dots, 0, v(\mu))$ is the $(n_1 + 1)$ -st row of $S(\mu)$. Set $v(\mu) = (v_1(\mu), \dots, v_{n_2}(\mu))$ and let w be a greatest common divisor of v_1, \dots, v_{n_2} . Then $S(\mu) = w(\mu)\tilde{S}(\mu)$ and $\det S(\mu) \in \mathbb{C} \setminus \{0\}$ imply

$$w = \alpha \in \mathbb{C} \setminus \{0\}.$$

Under this condition we can find a unimodular matrix $P \in \mathbb{C}^{n_2 \times n_2}[\mu]$ which has v as its first row,

$$P(\mu) = \begin{pmatrix} v(\mu) \\ * \\ \vdots \\ * \end{pmatrix}.$$

Using the special form of q_2 we obtain

$$q^*V(\mu) = v(\mu) = q_2^*P(\mu).$$

This implies

$$q_2^*P(\mu)(\lambda I - A_2(\mu))^{-1}P^{-1}(\mu) = q^*V(\mu)(\lambda I - A_2(\mu))^{-1}P^{-1}(\mu).$$

Since the vector (4.19) is entire, we see that also

$$q_2^*P(e^{-\lambda h})(\lambda I - A_2(e^{-\lambda h}))^{-1}P(e^{-\lambda h})^{-1}$$

is entire. Consequently (see Theorem 4.4) the delay system corresponding to

$$\tilde{A}_2(\mu) := P(\mu)A_2(\mu)P^{-1}(\mu)$$

is degenerate with respect to q_2 . If instead of $S(\mu)$ we take the unimodular matrix $T(\mu) = S(\mu) \text{diag}(I, P^{-1}(\mu))$, then the matrix $T^{-1}(\mu)A(\mu)T(\mu)$ is given by

$$T^{-1}(\mu)A(\mu)T(\mu) = \begin{pmatrix} A_1(\mu) & A_{1,2}(\mu)P^{-1}(\mu) \\ 0 & P(\mu)A_2(\mu)P^{-1}(\mu) \end{pmatrix}.$$

■

Appendix: A

Laplace-Transforms

In this appendix we collect some results on Laplace-transforms. With a few exceptions we do not provide proofs, but refer to the standard literature (see for instance [7]).

Let f be in $L^1_{loc}(0, \infty; \mathbb{C})$ and $\lambda \in \mathbb{C}$. Then the **Laplace-integral** of f at λ is defined by

$$\int_0^\infty e^{-\lambda t} f(t) dt = \lim_{\omega \rightarrow \infty} \int_0^\omega e^{-\lambda t} f(t) dt. \quad (\text{A.1})$$

We say that the Laplace-integral for f converges at λ if the limit in (A.1) exists, converges absolutely at λ if $\lim_{\omega \rightarrow \infty} \int_0^\omega e^{-t \operatorname{Re} \lambda} |f(t)| dt$ exists and converges uniformly on a set $D \subset \mathbb{C}$ if the limit in (A.1) exists uniformly for $\lambda \in D$.

If the Laplace-integral for f converges absolutely at λ_0 , so it also does in $\operatorname{Re} \lambda \geq \lambda_0$. Therefore the domain of absolute convergence of the Laplace-integral is an open or closed right half plane. We define the **abscissa of absolute convergence** by

$$\sigma_a(f) = \inf \{ \sigma \in \mathbb{R} \mid \text{The Laplace-integral for } f \text{ is absolutely convergent at } \sigma \}.$$

If the Laplace-integral converges at λ_0 , then it is uniformly convergent in any sector

$$\{ \lambda \in \mathbb{C} \mid |\arg(\lambda - \lambda_0)| \leq \varepsilon \}, \quad 0 \leq \varepsilon < \pi/2.$$

In particular it converges in $\operatorname{Re} \lambda > \operatorname{Re} \lambda_0$. Therefore the domain of convergence of the Laplace-integral is an open right half plane plus a subset of the boundary. We define the **abscissa of convergence** by

$$\sigma_c(f) = \inf \{ \sigma \in \mathbb{R} \mid \text{The Laplace-integral for } f \text{ converges at } \sigma \}.$$

It is clear that

$$-\infty \leq \sigma_c \leq \sigma_a \leq \infty.$$

All cases, except equality everywhere, are possible for these inequalities. By the uniform convergence of the Laplace-integral in sectors the function

$$\hat{f}(\lambda) = \int_0^\infty e^{-\lambda t} f(t) dt, \quad \operatorname{Re} \lambda > \sigma_c(f),$$

is holomorphic in the half plane $\operatorname{Re} \lambda > \sigma_c(f)$. We shall also use the notation $\mathcal{L}(f) = \hat{f}$. The derivatives of \hat{f} are given by

$$\frac{d^j \hat{f}}{d\lambda^j}(\lambda) = (-1)^j \int_0^\infty e^{-\lambda t} t^j f(t) dt, \quad \operatorname{Re} \lambda > \sigma_c(f).$$

\hat{f} is called the **Laplace-transform** of f . Frequently we shall denote by \hat{f} or $\mathcal{L}(f)$ also the function obtained by analytic continuation.

Of fundamental importance is the following uniqueness result:

Theorem A.1 *Let \hat{f} and \hat{g} be Laplace-transforms of functions f and g , respectively. If $\hat{f} = \hat{g}$ in some right half plane, then $f(t) = g(t)$ a.e. on $t \geq 0$.*

It is clear that taking Laplace-transforms is a linear operation. We next collect results on the behavior of the Laplace-transform with respect to integration, differentiation and convolution.

Theorem A.2 Let $f \in L^1_{loc}(0, \infty; \mathbb{C})$ with $\sigma_c(f) < \infty$ and set $g(t) = \int_0^t f(\tau) d\tau$, $t \geq 0$. Assume that the Laplace-integral for f is convergent at $\lambda_0 \in \mathbb{R}$. Then the Laplace-integral for g converges in $\text{Re } \lambda > 0$ if $\lambda_0 = 0$ and in $\{\lambda \in \mathbb{C} \mid \text{Re } \lambda > \lambda_0\} \cup \{\lambda_0\}$ if $\lambda_0 > 0$. Moreover,

$$\hat{g}(\lambda) = \frac{1}{\lambda} \hat{f}(\lambda)$$

and

$$g(t) = \begin{cases} O(1) & \text{if } \lambda_0 = 0, \\ o(e^{\lambda_0 t}) & \text{if } \lambda_0 > 0 \end{cases}$$

as $t \rightarrow \infty$.

Theorem A.3 Let f be locally absolutely continuous on $t \geq 0$ and suppose that $\sigma_c(\dot{f}) < \infty$. Then $\sigma_c(f) \leq \sigma_c(\dot{f})$ and

$$\mathcal{L}(\dot{f})(\lambda) = \lambda \mathcal{L}(f)(\lambda) - f(0).$$

Moreover, for any real λ_0 , where the Laplace-integral for \dot{f} converges, we have

$$f(t) = o(e^{\lambda_0 t}) \quad \text{as } t \rightarrow \infty.$$

Proposition A.4 Let $f_i \in L^1_{loc}(0, \infty; \mathbb{C})$, $i = 1, 2$, be given. Then the integral $\int_0^t f_1(t - \tau) f_2(\tau) d\tau$ exists a.e. on $t \geq 0$ and the function f defined by this integral, where it exists, and by $f(t) = 0$ otherwise is in $L^1_{loc}(0, \infty; \mathbb{C})$.

The function f whose existence is guaranteed by the above proposition is called the **convolution** of f_1 and f_2 , $f = f_1 * f_2$. The operation “*” is commutative and associative. We shall need the following results on smoothness of $f_1 * f_2$.

Theorem A.5 Let $f_i \in L^1_{loc}(0, \infty; \mathbb{C})$, $i = 1, 2$, be given. If f_1 is bounded on bounded intervals or if f_1 and f_2 are in $L^2_{loc}(0, \infty; \mathbb{C})$, then $f = f_1 * f_2$ is continuous on $t \geq 0$.

Theorem A.6 Let f_1 be locally absolutely continuous on $t \geq 0$ and f_2 be in $L^1_{loc}(0, \infty; \mathbb{C})$. Then $f = f_1 * f_2$ is locally absolutely continuous on $t \geq 0$ and

$$\dot{f} = \dot{f}_1 * f_2 + f_1(0) f_2 \quad \text{a.e. on } t \geq 0.$$

Concerning Laplace-transforms of convolutions we have:

Theorem A.7 Let $f_i \in L^1_{loc}(0, \infty; \mathbb{C})$, $i = 1, 2$, be given and suppose that $\sigma_a(f_1) \leq x_0$ and $\sigma_a(f_2) \leq x_0$. Then $\sigma_a(f_1 * f_2) \leq x_0$ and

$$\mathcal{L}(f_1 * f_2) = \mathcal{L}(f_1) \mathcal{L}(f_2).$$

If a function $\hat{f}(\lambda)$ is holomorphic in some right half plane, then it is of interest to know if it is a Laplace-transform.

Theorem A.8 Let \hat{f} be holomorphic in $\text{Re } \lambda > x_1$ and assume that

(i) for any $\varepsilon > 0$ and any $\delta > 0$ there exists a $K > 0$ such that

$$|\hat{f}(\lambda)| \leq \varepsilon \quad \text{for } \text{Re } \lambda \geq x_1 + \delta \text{ and } |\lambda| \geq K,$$

(ii) and the integral $\int_{-\infty}^{\infty} |f(x + iy)| dy$ exists for all $x > x_1$.

Then \hat{f} is the Laplace-transform of a function f which, for any $x > x_1$ is given by

$$f(t) = \int_{(x)} e^{\lambda t} \hat{f}(\lambda) d\lambda, \quad t \geq 0.$$

Here $\int_{(x)}$ means $\lim_{y \rightarrow \infty} (2\pi i)^{-1} \int_{x-iy}^{x+iy}$. A result of more constructive nature is contained in the following theorem.

Theorem A.9 Let \hat{f}_ν be the Laplace-transforms of f_ν , $\nu = 1, 2, \dots$, and assume that there exists an $x_0 \in \mathbb{R}$ such that

(i) $x_0 \geq \sigma_a(f_\nu)$, $\nu = 1, 2, \dots$,

(ii) $\sum_{\nu=1}^{\infty} \int_0^{\infty} e^{-x_0 t} |f_\nu(t)| dt$ is convergent.

Then the series $\sum_{\nu=1}^{\infty} \hat{f}_\nu$ converges uniformly in $\text{Re } \lambda \geq x_0$ and the series $\sum_{\nu=1}^{\infty} f_\nu(t)$ absolutely a.e. on $t \geq 0$. If we define $f(t) = \sum_{\nu=1}^{\infty} f_\nu(t)$, then $\sigma_a(f) \leq x_0$ and $\hat{f}(\lambda) = \sum_{\nu=1}^{\infty} \hat{f}_\nu(\lambda)$ for $\text{Re } \lambda \geq x_0$.

Finally we quote one version of the complex inversion formula for Laplace-transforms:

Theorem A.10 Let $f \in L^1_{\text{loc}}(0, \infty; \mathbb{C})$ with $\sigma_a(f) < \infty$ be given. Then for any $\gamma \geq \sigma_a(f)$ and any $t \geq 0$ where f is of bounded variation in a neighborhood of t the following formula is valid:

$$\int_{(\gamma)} e^{\lambda t} \hat{f}(\lambda) d\lambda = \begin{cases} \frac{1}{2}(f(t+0) + f(t-0)) & \text{if } t > 0, \\ \frac{1}{2}f(0+) & \text{if } t = 0. \end{cases}$$

For $t < 0$ the integral is always zero.

Appendix: B

Entire Functions

In this appendix we quote some facts on entire functions, which are used in the section on small solutions. As standard references we cite [5, 23].

Definition B.1 A function $f : \mathbb{C} \rightarrow \mathbb{C}$ is called an **entire function of exponential type** if and only if f is holomorphic in \mathbb{C} and there exist constants $\alpha, \beta \geq 0$ such that

$$|f(\lambda)| \leq \alpha e^{\beta|\lambda|} \quad \text{for all } \lambda \in \mathbb{C}.$$

The number

$$\tau_f = \limsup_{\rho \rightarrow \infty} \frac{1}{\rho} \ln M(\rho),$$

where $M(\rho) = \max_{|\lambda|=\rho} |f(\lambda)|$, is called the **exponential type** of f .

It is trivial that the sum and the product of two entire functions of exponential type are again such functions. Less trivial is the result on quotients:

Proposition B.2 *If f and g are entire functions of exponential type, then f/g is also an entire function of exponential type provided it is entire.*

For a proof of this proposition see for instance [23, p. 24].

A detailed description of the growth behavior of an entire function of exponential type at infinity given by the indicator function:

Definition B.3 *Let f be an entire function of exponential type. The function $h_f : [0, 2\pi] \rightarrow \mathbb{R}$ defined by*

$$h_f(\theta) = \limsup_{\rho \rightarrow \infty} \frac{1}{\rho} \ln |f(\rho e^{i\theta})|$$

is called the indicator function of f .

For a detailed representation of the general properties of indicator functions see for instance [23, Ch. 1, Sect. 15] or [5, Ch. 5]. We just mention the following result:

Proposition B.4 *Let f be an entire function of exponential type. If $f \not\equiv 0$, then h_f is finite and continuous.*

If we have information on the behavior of f on a vertical line, we obtain a very precise information on the indicator function. For our purpose very useful is the following result (cf. [23, p. 243] or [5, p. 116]):

Theorem B.5 *Let $f \not\equiv 0$ be a function of exponential type. If*

$$\int_{-\infty}^{\infty} \frac{\ln^+ |f(i\omega)|}{1 + \omega^2} d\omega < \infty, \quad (\text{B.1})$$

then

$$h_f(\theta) = -k \cos \theta, \quad \theta \in [\pi/2, 3\pi/2],$$

and, for θ in a dense subset of $[\pi/2, 3\pi/2]$,

$$h_f(\theta) = \lim_{\rho \rightarrow \infty} \frac{1}{\rho} \ln |f(\rho e^{i\theta})|.$$

The function \ln^+ is defined by $\ln^+ \xi = \max(0, \ln \xi)$, $\xi > 0$. Condition (B.1) can be replaced by (see [23, p. 251])

$$\int_{-\infty}^{\infty} |f(i\omega)|^2 d\omega < \infty. \quad (\text{B.2})$$

Of fundamental importance for us is the following characterization of those entire functions of exponential type which are two-sided Laplace-transforms of functions with compact support.

Theorem B.6 (Paley-Wiener) *Let $f \not\equiv 0$ be an entire function of exponential type. Then the following two statements are equivalent:*

- (i) *There exist constants $H', H \in \mathbb{R}$ with $-H' < H$ and a square-integrable F with support in $[-H', H]$ such that*

$$f(\lambda) = \int_{-H'}^H e^{-\lambda t} F(t) dt, \quad \lambda \in \mathbb{C}.$$

(ii) $\int_{-\infty}^{\infty} |f(i\omega)|^2 d\omega < \infty.$

Moreover, if we take $H' = h_f(0)$ and $H = h_f(\pi)$, then the interval $[-H', H]$ cannot be replaced by a smaller one.

For a proof of this theorem see [23, p. 387], [5, p. 103] or [7, Vol. III, pp. 238, 241].

Finally, Hadamard's factorization theorem assumes the following form for functions of exponential type (see [23, p. 24] or [5, p. 22]):

Theorem B.7 *Let f be an entire function of exponential type and let (a_n) be the finite or infinite sequence of nonzero zeros of f . Moreover, assume that $\lambda = 0$ is a zero of multiplicity m . Then there exist numbers $\alpha, \beta \in \mathbb{C}$ such that*

$$f(\lambda) = \lambda^m e^{\alpha + \beta\lambda} \prod_n \left(1 - \frac{\lambda}{a_n}\right) e^{p\lambda}, \quad \lambda \in \mathbb{C},$$

where $p = 0$ or $p = 1$.

Appendix: C

An Unsymmetric Fubini Theorem

For the convenience of the reader we state in this appendix the unsymmetric Fubini theorem of [6]. In the following it is always assumed that functions which are of bounded variation on bounded intervals are normalized by the requirement to be right-hand continuous.

Theorem C.1 *Assume that the functions $k : \mathbb{R} \rightarrow \mathbb{R}$, $s : \mathbb{R} \rightarrow \mathbb{R}$ and $p : \mathbb{R} \times \mathbb{R} \rightarrow \mathbb{R}$ satisfy:*

- a) k is of bounded variation on bounded intervals.
- b) s is Borel measurable on \mathbb{R} .
- c) p is Borel measurable on $\mathbb{R} \times \mathbb{R}$ and, for k -almost all $\sigma \in \mathbb{R}$, the function $p(\sigma, \cdot)$ is of bounded variation on bounded intervals.

Define

$$V(\sigma, \tau) = \begin{cases} \int_0^\tau |d_\nu p(\sigma, \nu)| & \text{for } \tau \geq 0, \\ -\int_\tau^0 |d_\nu p(\sigma, \nu)| & \text{for } \tau < 0. \end{cases}$$

If

(i) $\int_{-\infty}^{\infty} V(\sigma, \tau) |dk(\sigma)| < \infty$ for all τ

and

(ii) $\int_{-\infty}^{\infty} |s(\tau)| d\tau \int_{-\infty}^{\infty} V(\sigma, \tau) |dk(\sigma)| < \infty$ or
 $\int_{-\infty}^{\infty} |dk(\sigma)| \int_{-\infty}^{\infty} |s(\tau)| |d_\tau p(\sigma, \tau)| < \infty,$

then the other integral under (ii) also exists and

$$\int_{-\infty}^{\infty} s(\tau) d\tau \int_{-\infty}^{\infty} p(\sigma, \tau) dk(\sigma) = \int_{-\infty}^{\infty} dk(\sigma) \int_{-\infty}^{\infty} s(\tau) d\tau p(\sigma, \tau).$$

Appendix: D

Results on Polynomial Rings and Modules over Polynomial Rings

In this appendix we present the basic definitions and results concerning the theory of polynomial rings and modules over polynomial rings. We give proofs for those results where a proof is not available in the literature in the form needed here.

We denote by $\mathbb{C}[\lambda_1, \dots, \lambda_m]$ the ring of polynomials in the indeterminates $\lambda_1, \dots, \lambda_m$, $m \geq 1$, over the field \mathbb{C} . The ring $\mathbb{C}[\lambda]$ is a Euclidean ring and consequently also a principal ideal domain. The rings $\mathbb{C}[\lambda_1, \dots, \lambda_m]$ with $m \geq 2$ are not even principal ideal domains, but unique factorization domains. Therefore the concepts "greatest common divisor" and "least common multiple" are well defined in all of these rings. If r_1, r_2 are polynomial in $\mathbb{C}[\lambda]$, then there exists a greatest common divisor $d \in \mathbb{C}[\lambda]$ which can be computed by the Euclidean algorithm. Moreover there exist polynomials $R_1, R_2 \in \mathbb{C}[\lambda]$ with

$$d = r_1 R_1 + r_2 R_2.$$

This result in $\mathbb{C}[\lambda]$ has the following analogue in the rings $\mathbb{C}[\lambda_1, \dots, \lambda_m]$, $m \geq 2$:

Lemma D.1 *Let $r_1, r_2 \in \mathbb{C}[\lambda_1, \dots, \lambda_m]$, $m \geq 2$, be given and let d be a greatest common divisor of r_1, r_2 . Then there exist polynomials $R_1, R_2 \in \mathbb{C}[\lambda_1, \dots, \lambda_m]$ and a polynomial $w \in \mathbb{C}[\lambda_1, \dots, \lambda_{m-1}]$ such that*

$$\begin{aligned} r_1(\lambda_1, \dots, \lambda_m) R_1(\lambda_1, \dots, \lambda_m) + r_2(\lambda_1, \dots, \lambda_m) R_2(\lambda_1, \dots, \lambda_m) \\ = w(\lambda_1, \dots, \lambda_{m-1}) d(\lambda_1, \dots, \lambda_m). \end{aligned}$$

A proof of this result can be found in [29].

Next we state some definitions and results concerning module theory. As general references for module theory we quote [1], [3], [4], [16], [27].

Let M be an additive, commutative group and R a commutative ring with multiplicative unit 1. Then M (more precisely (M, R)) is called a **module** over R if and only if there is a scalar multiplication $(r, x) \in R \times M \rightarrow rx \in M$ satisfying

$$\begin{aligned} r(x_1 + x_2) &= rx_1 + rx_2, & r \in R, x_1, x_2 \in M, \\ (r_1 + r_2)x &= r_1x + r_2x, & r_1, r_2 \in R, x \in M, \text{ and} \\ 1 \cdot x &= x, & x \in M. \end{aligned}$$

The modules which are most similar to vector spaces are the free modules. A module M over R is called a **free module** if and only if there exists a basis $e_1, \dots, e_n \in M$ for M , i.e., every element $x \in M$ has a unique representation $x = \alpha_1 e_1 + \dots + \alpha_n e_n$, $\alpha_i \in R$, $i = 1, \dots, n$, and $\alpha_1 e_1 + \dots + \alpha_n e_n = 0$ implies $\alpha_1 = \dots = \alpha_n = 0$ (linear independence). The modules $\mathbb{C}^n[\lambda_1, \dots, \lambda_n]$ are free modules, a basis being $e_1 =$

$\text{col}(1, 0, \dots, 0), \dots, \text{col}(0, \dots, 0, 1)$ (canonical basis). A set U is called a **submodule** of M if and only if it is again a module over R , i.e., for $\alpha_1, \alpha_2 \in R$ and $x_1, x_2 \in U$ we have also $\alpha_1 x_1 + \alpha_2 x_2 \in U$.

We shall need results on the modules $M = \mathbb{C}^n[\lambda_1, \dots, \lambda_m]$ over the ring $R = \mathbb{C}[\lambda_1, \dots, \lambda_m]$. The module $\mathbb{C}^n[\lambda_1, \dots, \lambda_m]$ consists of all n -vectors $\text{col}(x_1, \dots, x_n)$ with $x_i \in \mathbb{C}[\lambda_1, \dots, \lambda_m]$, $i = 1, \dots, n$. The module $\mathbb{C}^n[\lambda]$ is special among the modules $\mathbb{C}^n[\lambda_1, \dots, \lambda_m]$ by the following property:

Lemma D.2 *Every submodule of $\mathbb{C}[\lambda]$ is a free module.*

This result in fact is valid for free modules over principal ideal domains (see [16, p. 78] or [27, p. 109]).

An important question in module theory is the following: If X is a submodule of M , does there exist another submodule Y of M such that $M = X \oplus Y$? We know that the answer is "yes" for vector spaces. But even for the module $\mathbb{C}^n[\lambda]$ the answer in general is "no". However we have also a positive result. In order to state this result we need a definition. For $a_1, \dots, a_k \in \mathbb{C}^n[\lambda]$ let $S = \text{span}(a_1, \dots, a_k) = \{\alpha_1 a_1 + \dots + \alpha_k a_k \mid \alpha_i \in \mathbb{C}[\lambda], i = 1, \dots, k\}$. Obviously S is a submodule of $\mathbb{C}^n[\lambda]$, the *submodule generated by a_1, \dots, a_k* .

Proposition D.3 *Let $A \in \mathbb{C}^{n \times n}[\lambda]$ (i.e., A is an $n \times n$ -matrix with elements in $\mathbb{C}[\lambda]$). Then there exists a submodule X of $\mathbb{C}^n[\lambda]$ such that*

$$\mathbb{C}^n[\lambda] = \ker A \oplus X.$$

We can take $X = \text{span}(x_1, \dots, x_k)$ for any elements $x_1, \dots, x_k \in \mathbb{C}^n[\lambda]$ such that Ax_1, \dots, Ax_k is a basis for range A .

This result is a special case of the corresponding result for epimorphisms where the range is a free submodule (see [27, p. 108]). Note that by Lemma D.2 the submodule range A is a free module. Take a basis y_1, \dots, y_k of range A and elements $x_1, \dots, x_k \in \mathbb{C}^n[\lambda]$ with $y_i = Ax_i$, $i = 1, \dots, k$. Observe that x_1, \dots, x_k are linearly independent, because otherwise also y_1, \dots, y_k would be linearly dependent and could not be a basis for range A .

For matrices $A \in \mathbb{C}^{n \times n}[\mu_1, \dots, \mu_m]$ we define the characteristic polynomial $\chi_A \in \mathbb{C}[\lambda, \mu_1, \dots, \mu_m]$ by

$$\chi_A(\lambda, \mu_1, \dots, \mu_m) = \det(\lambda I - A(\mu_1, \dots, \mu_m)).$$

For $A \in \mathbb{C}^{n \times n}[\mu_1, \dots, \mu_m]$ and $p \in \mathbb{C}[\lambda, \mu_1, \dots, \mu_m]$ we set (with some abuse of notation)

$$p(A) = p(A, \mu_1, \dots, \mu_m) \in \mathbb{C}^{n \times n}[\mu_1, \dots, \mu_m].$$

Then as in vector space theory we have (see for instance [27, p. 246])

Theorem D.4 (Cayley-Hamilton) *For every matrix $A \in \mathbb{C}^{n \times n}[\mu_1, \dots, \mu_m]$, $m \geq 1$, we have*

$$\chi_A(A) = 0.$$

On the basis of Proposition D.3 we can prove the following result on block-triangularization of matrices in $\mathbb{C}^{n \times n}[\mu]$:

Theorem D.5 ([19, Theorem 2.1]) *Let $A \in \mathbb{C}^{n \times n}[\mu]$ be given and assume that*

$$\chi_A = p_1 p_2,$$

where $p_1, p_2 \in \mathbb{C}[\lambda, \mu]$ are relatively prime (i.e., 1 is a greatest common divisor) and monic (i.e., the coefficient of the largest power of λ is 1). Set $n_i = \text{degree } p_i$ and assume $n_i > 0$, $i = 1, 2$. Then there exists a unimodular matrix $S \in \mathbb{C}^{n \times n}[\mu]$ (i.e., $\det S(\mu) \equiv c \in \mathbb{C} \setminus \{0\}$) or, equivalently, also $S^{-1}(\mu) \in \mathbb{C}^{n \times n}[\mu]$ such that

$$\tilde{A} = S^{-1}AS = \begin{pmatrix} A_1 & A_{1,2} \\ 0 & A_2 \end{pmatrix} \in \mathbb{C}^{n \times n}[\mu],$$

$$\chi_{A_i} = p_i, \quad i = 1, 2.$$

In general we cannot find S such that $A_{1,2} = 0$.

Proof. We set $C = p_1(A)$ and choose a basis $\tilde{e}_1, \dots, \tilde{e}_r$ of $\ker C$ (observe that $\ker C$ is a free module), where $0 < r < n$. Choose $\tilde{e}_{r+1}, \dots, \tilde{e}_n \in \mathbb{C}^n[\mu]$ such that $C\tilde{e}_{r+1}, \dots, C\tilde{e}_n$ is a basis for $\text{range } C$. Then according to Proposition D.3 we have

$$\mathbb{C}^n[\mu] = \ker C \oplus \text{span}(\tilde{e}_{r+1}, \dots, \tilde{e}_n).$$

Note that as in vector space theory all bases of $\mathbb{C}^n[\mu]$ have the same number of elements.

Let $x \in \ker C$, i.e., we have $Cx = 0$. Since A and C commute, this implies $C Ax = ACx = 0$, i.e., $Ax \in \ker C$. Consequently $\ker C$ is A -invariant. Let $S \in \mathbb{C}^{n \times n}[\mu]$ denote the matrix corresponding to the change of bases $e_1, \dots, e_n \rightarrow \tilde{e}_1, \dots, \tilde{e}_n$ and denote by \tilde{A} the representation of the endomorphism $x \rightarrow Ax$ with respect to the basis $\tilde{e}_1, \dots, \tilde{e}_n$. Then we have $\tilde{A} = S^{-1}AS$. In view of the invariance of $\ker C$ with respect to this endomorphism we see that \tilde{A} must have the form given in the theorem.

It remains to prove $\chi_{A_1} = p_1$. Then $\chi_A = \chi_{A_1}\chi_{A_2}$ automatically implies $\chi_{A_2} = p_2$. Let $\mathbb{C}(\mu)$ denote the field of rational functions of μ with coefficients in \mathbb{C} and $\mathbb{C}^n(\mu)$ the vector space of all n -vectors with elements in $\mathbb{C}(\mu)$. Then we can view A and C also as matrices in $\mathbb{C}^{n \times n}(\mu)$. Let $x \in \mathbb{C}^n(\mu)$ with $Cx = 0$ be given. We can write x as

$$x = \frac{1}{s}\tilde{x}, \quad s \in \mathbb{C}(\mu), \quad \tilde{x} \in \mathbb{C}^n[\mu],$$

where s is the least common multiple of the denominators of the coordinates of x . Then $Cx = 0$ also implies $C\tilde{x} = 0$, i.e.,

$$\tilde{x} = \sum_{i=1}^r \alpha_i \tilde{e}_i, \quad \alpha_i \in \mathbb{C}[\mu], \quad i = 1, \dots, r.$$

This implies $x = \sum_{i=1}^r (\alpha_i/s)\tilde{e}_i$. We conclude that $\tilde{e}_1, \dots, \tilde{e}_r$ is also a basis for $\ker C$ in $\mathbb{C}(\mu)$. But then vector space theory implies $\chi_{A_1} = p_1$.

That in general we have $A_{1,2} \neq 0$ is demonstrated by the following example. Let

$$A = \begin{pmatrix} \mu & 1 \\ 0 & 0 \end{pmatrix}$$

with $\chi_A(\lambda, \mu) = (\lambda - \mu)\lambda$, $p_1(\lambda, \mu) = \lambda - \mu$, $p_2(\lambda, \mu) = \lambda$. From

$$\tilde{A} = \begin{pmatrix} A_1 & A_{1,2} \\ 0 & A_2 \end{pmatrix}$$

and $\chi_{A_1} = \lambda - \mu$, $\chi_{A_2} = \lambda$ we conclude that $A_1 = (\mu)$ and $A_2 = (0)$. Assume that we can choose a unimodular $S \in \mathbb{C}^2[\mu]$ such that $A_{1,2} = (0)$ and set

$$S = \begin{pmatrix} s_{1,1} & s_{1,2} \\ s_{2,1} & s_{2,2} \end{pmatrix}, \quad S^{-1} = \begin{pmatrix} t_{1,1} & t_{1,2} \\ t_{2,1} & t_{2,2} \end{pmatrix}.$$

Then a simple calculation shows that

$$\begin{pmatrix} \mu & 0 \\ 0 & 0 \end{pmatrix} = S^{-1} \begin{pmatrix} \mu & 1 \\ 0 & 0 \end{pmatrix} S$$

is equivalent to

$$t_{1,1}(s_{1,2}\mu + s_{2,2}) = 0, \tag{D.1}$$

$$t_{2,1}(s_{1,2}\mu + s_{2,2}) = 0, \tag{D.2}$$

$$t_{2,1}(s_{1,1}\mu + s_{2,1}) = 0, \tag{D.3}$$

$$t_{1,1}(s_{1,1}\mu + s_{2,1}) = \mu. \tag{D.4}$$

Case 1: $t_{1,1} = 0$.

Equation (D.4) implies $\mu = 0$, a contradiction.

Case 2: $s_{1,2}\mu + s_{2,2} = 0$.

Then equations (D.1) and (D.2) are satisfied. Assume that $s_{1,1}\mu + s_{2,1} = 0$. Then (D.4) implies $\mu = 0$, which is impossible. Thus we have $s_{1,1}\mu + s_{2,1} \neq 0$. From (D.3) we then get $t_{2,1} = 0$, i.e., we have

$$S^{-1} = \begin{pmatrix} t_{1,1} & t_{1,2} \\ 0 & t_{2,2} \end{pmatrix}.$$

Consequently we have $s_{2,1} = 0$. But this and $s_{1,2}\mu + s_{2,2} = 0$ imply $s_{2,2} = 0$, so that $\det S(\mu) \equiv 0$.

Thus we have shown that neither case is possible, i.e., we never can get $A_{1,2} = 0$. Analogously we can see that A cannot be transformed to $\text{diag}(0, \mu)$. ■

The result of Theorem D.5 does not carry over to $\mathbb{C}^n[\mu_1, \dots, \mu_m]$ in case $m \geq 2$. The following example was given in [21]. Let

$$A(\mu, \nu) = \begin{pmatrix} \mu^2 & \mu\nu \\ \mu\nu & \nu^2 \end{pmatrix} \in \mathbb{C}^{2 \times 2}[\mu, \nu]$$

be given. Then we have $\chi_A(\lambda, \mu, \nu) = \lambda(\lambda - \mu^2 - \nu^2) =: p_1(\lambda, \mu, \nu)p_2(\lambda, \mu, \nu)$. We have $p_1(A) = A$ and $\ker p_1(A) = \text{span}(\text{col}(\nu, -\mu))$. Assume that there exists a free submodule $X = \text{span}(\text{col}(\alpha, \beta))$ such that

$$\mathbb{C}^2[\mu, \nu] = \ker p_1(A) \oplus X.$$

This implies that the vectors $\text{col}(1, 0)$ and $\text{col}(0, 1)$ (which constitute a basis for $\mathbb{C}^2[\mu, \nu]$) are linear combinations of $\text{col}(\nu, -\mu)$ and $\text{col}(\alpha, \beta)$, i.e., there exist polynomials $p_i, q_i \in \mathbb{C}[\mu, \nu]$, $i = 1, 2$, such that

$$1 = \nu p_1 + \alpha p_2, \tag{D.5}$$

$$0 = -\mu p_1 + \beta p_2, \tag{D.6}$$

$$0 = \nu q_1 + \alpha q_2, \tag{D.7}$$

$$1 = -\mu q_1 + \beta q_2. \tag{D.8}$$

From (D.6) we see that μ divides βp_2 .

Case 1: $\mu \mid p_2$.

This implies $p_2 = \mu\tilde{p}_2$, $\tilde{p}_2 \in \mathbb{C}[\mu, \nu]$, and in view of (D.6) $\mu(-p_1 + \beta\tilde{p}_2) = 0$. Consequently we have $p_1 = \beta\tilde{p}_2$. Then (D.5) implies

$$1 = \tilde{p}_2(\nu\beta + \mu\alpha),$$

which is impossible.

Case 2: $\mu \mid \beta$.

In this case we have $\beta = \mu\tilde{\beta}$, $\tilde{\beta} \in \mathbb{C}[\mu, \nu]$, and get from (D.8)

$$1 = \mu(-q_1 + \tilde{\beta}q_2),$$

which again is impossible.

Thus we have shown that $\ker p_1(A)$ is not a direct summand in $\mathbb{C}^2[\mu, \nu]$. For p_2 we have

$$p_2(A) = \begin{pmatrix} -\nu^2 & \mu\nu \\ \mu\nu & -\mu^2 \end{pmatrix}$$

and $\ker p_2(A) = \text{span}(\text{col}(\mu, \nu))$. Analogously as above we prove that also $\ker p_2(A)$ is not a direct summand of $\mathbb{C}^2[\mu, \nu]$.

References

- [1] M. Auslander and D. Buchsbaum, Groups, Rings, Modules, Harper and Row, New York 1974.
- [2] R. Bellman and K. L. Cooke, Differential-Difference Equations, Academic Press, New York 1963.
- [3] N. Bourbaki, Éléments de Mathématique, Livre II: Algèbre, Chapitre VII: Modules sur les Anneaux Principaux, Hermann, Paris 1964.
- [4] N. Bourbaki, Éléments de Mathématique, Livre II: Algèbre, Chapitre II: Algèbre Linéaire, Hermann, Paris 1970.
- [5] R. P. Boas, Jr., Entire Function, Academic Press, New York 1954.
- [6] R. H. Cameron and W. T. Martin, *An unsymmetric Fubini theorem*, Bull. Amer. Math. Soc. **47** (1941), 121–125.
- [7] G. Doetsch, Handbuch der Laplace-Transformation, Vols. I – III, Birkhäuser Verlag, Basel 1950/55/56.
- [8] F. R. Gantmacher, Matrizenrechnung, Vol. I, Deutscher Verlag der Wissenschaften, Berlin 1965.
- [9] W. Gröbner, Matrizenrechnung, Bibliographisches Institut Mannheim, Mannheim 1966.
- [10] J. K. Hale, Functional Differential Equations, Springer Verlag, New York 1971.
- [11] Hale, J.K., LaSalle, J.P. and M. Slemrod (1973) Theory of a general class of dissipative processes. J. Math. Anal. Appl. **39**, 177-191.
- [12] J. K. Hale and S. M. Verduyn Lunel, Introduction to Functional Differential Equations, Springer Verlag, Berlin 1993.
- [13] D. Henry, *Small solutions of linear autonomous functional differential equations*, J. Differential Eqs. **8** (1970), 494 – 501.

- [14] K. Hensel and G. Landsberg, *Theorie der algebraischen Funktionen einer Variablen*, Leipzig, 1902.
- [15] E. Hewitt and K. Stromberg, *Real and Abstract Analysis*, Springer Verlag, Berlin 1969.
- [16] N. Jacobson, *Lectures in Abstract Algebra, Vol. II: Linear Algebra*, van Nostrand, Princeton, N. J., 1953.
- [17] F. Kappel, *Linear autonomous functional differential equations in the state space C* , Institute für Mathematik, Universität und Technische Universität Graz, Technical Report No. 34 – 1984, January 1984.
- [18] F. Kappel, *On degeneracy of functional-differential equations*, J. Differential Eqs. **22** (1976), 250 – 267.
- [19] F. Kappel, *Degenerate difference-differential equations: algebraic theory*, J. Differential Eqs. **24** (1977), 99 – 126.
- [20] F. Kappel and H. K. Wimmer, *An elementary divisor theory for autonomous linear functional differential equations*, J. Differential Eqs. **21** (1976), 134 – 147.
- [21] S. Khabbaz and G. Stengle, *Normal forms for analytic matrix valued functions*, in "Proceedings of the Liverpool Singularities Symposium II", Springer Verlag, New York 1971.
- [22] V. Lakshmikantham and S. Leela: *Differential and integral inequalities, theory and applications*, volume 1. Academic Press. (1969).
- [23] B. J. Levin, *Distribution of Zeros of Entire Functions*, Amer. Math. Soc., Providence, R. I., 1964.
- [24] B. W. Levinger, *A folk theorem in functional differential equations*, J. Differential Eqs. **4** (1968), 612 – 619.
- [25] S. M. V. Lunel, *Exponential type calculus for linear delay equations*, PhD-Thesis, Centrum voor Wiskunde en Informatica, Amsterdam 1988.
- [26] J. Mallet-Paret, *Roger D. Nussbaum and P. Paraskevopoulos*, "Periodic Solutions for Functional Differential Equations with Multiple State-Dependent Time Lags, LCDS 9316 December (1993).
- [27] E. Oeljeklaus and R. Remmert, *Lineare Algebra I*, Springer Verlag, New York 1974.
- [28] A. Pazy, *Semigroups of Linear Operators and Applications to Partial Differential Equations*, Springer-Verlag, New York, 1983.
- [29] O. Perron, *Algebra I*, de Gruyter, Berlin 1932.

- [30] L. Weiss, *On the controllability of delay-differential systems*, SIAM J. Control **5** (1967), 575 – 587.
- [31] K. Yosida, *Functional Analysis*, Springer Verlag, Berlin 1974.
- [32] A. M. Zverkin, *On the pointwise completeness of systems with delay*, Differential'nye Uravnenija **9** (1973), 430 – 436.

II

**HOPF BIFURCATION, CENTRE
MANIFOLDS AND NORMAL FORMS
FOR DELAY DIFFERENTIAL
EQUATIONS**

Chapter 4

VARIATION OF CONSTANT FORMULA FOR DELAY DIFFERENTIAL EQUATIONS

M.L. Hbid

University Cadi Ayyad , Marrakech, Morocco.

hbid@ucam.ac.ma

K. Ezzinbi

University Cadi Ayyad , Marrakech, Morocco.

ezzinbi@ucam.ac.ma

1. Introduction

The variation of constants formula for delay differential equations has for some time been a puzzling part of the theory. For the general inhomogeneous linear equation

$$\frac{dx}{dt} = Lx_t + f(t) \tag{1.1}$$

with initial value $x_0 = 0$, the solution reads

$$x_t = \int_0^t T_L(t-s)X_0f(s)ds \tag{1.2}$$

in which X_0 is the matrix-valued function defined by

$$X_0(\theta) = 0, \text{ for } \theta < 0; X_0(0) = Id_{\mathbb{R}^n}$$

and $T_L(t)$ is the semigroup associated with the homogeneous equation on the space $\mathcal{C} = \mathcal{C}([-r, 0], \mathbb{R}^n)$. Formula (1.2) indicates that $T_L(t)$ is evaluated at X_0 although this function (only considering the column vectors) is not continuous and so is not in the space where the semigroup is defined. In the literature, this odd fact is discretely overlooked by

using the expression "formal". One should note that a rigorous variation of constants formula exists: it is enough to use the fundamental solution $U(t)$ instead of $T_L(t)X_0$. In terms of $U(t)$, the solution x reads

$$x(t) = \int_0^t U(t-s)f(s)ds$$

The shortcoming of the above formula is that it is not expressed at the level of the phase space of the equation, which makes it difficult to use in the study of dynamical features of the solutions. The inconvenience caused by this apparent inconsistency is particularly visible when dealing with semilinear equations and stability or bifurcation issues. A first step in the direction of resolving this inconsistency was made by Chow and Mallet-Paret. In a later work (1980, not published), Arino proposed a solution close to the one proposed in , that is, to work in the space \mathcal{C}^1 instead of \mathcal{C} . These approaches are in fact very close to one which emerged a few years later, first, in a completely different context, that is, the theory of integrated semigroups. We will come to this theory last part of this chapter, it will be discussed and used in different context by M.Adimy and K.Ezzinbi in the third part of this book . Recently, Maniar, Rhandi et al .use extrapolation theory to discuss the same problem. Another approach burgeoned in the mid-eighties (1984-85) within a group of five people, Ph.Clement, O.Diekmann, M.Gyllenberg, H.J.A.M.Heijmans and H.R.Thieme (1985), that is, the approach of embedding the problem set in a larger space containing not only continuous functions but also such functions as X_0 , a space intermediary between the space \mathcal{C} and its bidual. This approach was not new, a thorough study of the relationships between the dual and the adjoint semigroups has been performed by E.Hille and R.S.Phillips(1957), and a number of important results are to be found in their book. It seems that it had been revived by H.Amann in a completely different context. In the next section, We will now give a very short summary of dual semigroups and we will show how it can be used to provide a rigorous variation of constants formula in the case of delay differential equations. The last section of this chapter will be devoted to show how the theory of integrated semigroups can be used to provide a rigorous variation of constants formula. An important consequence of both of these theories is to give new and interesting perspectives of DDE.

2. Variation Of Constant Formula Using Sun-Star Machinery

2.1 Duality and semigroups

Let A be the infinitesimal generator of a C_0 -semi-group $(T(t))_{t \geq 0}$ in a Banach space X .

$T^*(t)$ is a semigroup on the dual space X^* of X . In the general case $T^*(t)$ is not strongly continuous. It is strongly continuous when X is reflexive. Following Hille and Phillips (1957)[21], we define

$$X^\odot = \left\{ x^* \in X^* : \lim_{t \rightarrow 0} \|T^*(t)x^* - x^*\| = 0 \right\} \tag{2.3}$$

X^\odot (pronounced as X – sun) is the space of strong continuity of $T^*(t)$. It is a closed subspace of X^* . One can determine X^\odot in terms of A^* . In fact, we have ([21]):

$$X^\odot = \overline{\overline{D(A^*)}} \tag{2.4}$$

(this is the closure with respect to the strong topology of X^* , this result shows that $X^\odot \supseteq D(A^*)$). The restriction of $T^*(t)$ to X^\odot , denoted $T^\odot(t)$, is a strongly continuous semigroup of linear bounded operators on the space X^\odot .

The infinitesimal generator of $T^\odot(t)$ is the operator denoted A^\odot , which is the restriction of A^* , to the domain

$$D(A^\odot) = \{ x^* \in D(A^*) : A^*x^* \in X^\odot \}$$

$D(A^\odot)$ is weak* dense in X^* . One can repeat the construction starting from X^\odot and $T^\odot(t)$, that is, we can the space $X^{\odot*}$ from thee injection of X^\odot in X^* , we have $X^{\odot*}$ contains X^{**} , with continuous injection. Since X^{**} contains X , X can be considered as subspace of $X^{\odot*}$, and, in addition X is a closed subspace of $X^{\odot*}$. By the same operations as above we define $X^{\odot\odot}$

$$X^{\odot\odot} = \left\{ x^{\odot*} \in X^{\odot*} : \lim_{t \rightarrow 0} \|T^{\odot*}(t)x^{\odot*} - x^{\odot*}\| = 0 \right\} \tag{2.5}$$

and $T^{\odot\odot}(t)$ is the restriction of $T^{\odot*}(t)$ to $X^{\odot\odot}$.

Definition: X is called sun-reflexive with respect to A if and only if $X = X^{\odot\odot}$.

remark 1 *This equality should be understood as identification : we notice earlier that X can be identified to a closed subspace of $X^{\odot*}$. In the case of sun-reflexivity this space $X^{\odot\odot}$.*

In the sun-reflexive case, we have: $A^{\odot\odot} = A$ and $T^{\odot\odot}(t) = T(t)$.

2.1.1 The variation of constant formula:. Given a Banach space X , an operator A_0 which is the infinitesimal generator of a C_0 -semigroup $T_0(t)$. We assume that X is sun reflexive with respect to A_0 . Let be $B \in \mathcal{L}(X^{\odot*})$.

We consider the following equation

$$\frac{dx}{dt} = A_0x(t) + Bx(t). \tag{2.6}$$

B is a perturbation of A_0 . At first sight this perturbation doesn't make sense since B takes values in a space bigger than X . The only way to make it meaningful is to look for $x(t)$ in a bigger space in fact in the space $X^{\odot*}$. Assuming that $x(t)$ lies in this space, one can write equation (2.6) in the form

$$x(t) = T_0(t)x_0 + \int_0^t T_0^{\odot*}(t-s)Bx(s)ds \tag{2.7}$$

where $x(0) = x_0$.

Using a method of successive approximations, one can show that the equation (2.7) has each initial value x_0 one and only one $x(t)$ defined for all $t \geq 0$. We denote $T(t)x_0 = x(t)$. $T(t)$ is a semi-group strongly continuous in $X^{\odot*}$.

We will now show that $T(t)$ is a C_0 -semigroup on X . The proof goes through the next lemma:

Lemma 18 *Let $f : [0, +\infty[\rightarrow X^{\odot*}$ be norm-continuous. Then,*

$$t \rightarrow \int_0^t T_0^{\odot*}(t-s)f(s)ds$$

is a norm-continuous $X^{\odot\odot}$ -valued function

Theorem 1 *Given a Banach space X , an operator A_0 which is the infinitesimal generator of a C_0 -semigroup $T_0(t)$. We assume that X is sun reflexive with respect to A_0 . Let be $B \in \mathcal{L}(X^{\odot*})$. Then, equation 2.7 has, for each x_0 in X , a unique solution defined on $[0, +\infty[$ with values in X , continuous and such that $x(0) = x_0$. The map $T(t)x_0 = x(t)$ is continuous on X .*

Theorem 2 *Under the same assumptions as the above theorem, let A be the infinitesimal generator of $T(t)$. Then, we have*

$$D(A) = \{x \in D(A_0^{\odot*}) : A_0^{\odot*}x + Bx \in X\} \tag{2.8}$$

$$Ax = A_0^{\odot*}x + Bx \tag{2.9}$$

X is sun-reflexive with respect to A . Finally, $D(A) = D(A_0^{\odot*})$ and $A = A_0^{\odot*} + B$.

We have all the ingredients necessary for the application to the delay differential equations, which will be considered next.

2.2 Application to delay differential equations

2.2.1 The trivial equation.: In the sequel we present some properties of the unperturbed semi-group $\{T_0(t), t \geq 0\}$ related to the trivial equation:

$$\begin{cases} \frac{dx}{dt} = 0, \\ x(\theta) = \varphi(\theta), \end{cases}$$

which is given by

$$(T_0(t))\varphi(\theta) = \begin{cases} \varphi(0) & \text{if } t + \theta \geq 0, \\ \varphi(t + \theta) & \text{if } t + \theta \leq 0. \end{cases}$$

The semi-group $\{T_0(t), t \geq 0\}$ is generated by $A_0\varphi = \dot{\varphi}$ with

$$D(A_0) = \left\{ \varphi \in C^1([-1, 0], \mathbb{R}), \dot{\varphi}(0) = 0 \right\} \left(\dot{\varphi} = \frac{d\varphi}{dt} \right).$$

Let IE^* be represented by $BV([0, +\infty[, \mathbb{R})$, with the pairing given by

$$\langle f, \varphi \rangle = \int_0^{+\infty} df(\tau)\varphi(-\tau).$$

Most of the following results are borrowed from Diekmann and van Gils (1990). We have just adapted them to the specific equation considered here.

Lemma 19 [33] *The semigroup $T_0^*(t)$ is given by the formula*

$$(T_0^*(t)f)(\tau) = f(t + \tau) \text{ for } \tau > 0.$$

Its generator A_0^ verifies,*

$$D(A_0^*) = \left\{ f : f(t) = f(0+) + \int_0^t g(\tau)d\tau \text{ for } t > 0, g \in NBV \text{ and } g(1) = 0 \right\},$$

and for

$$f \in D(A_0^*), A_0^*(f) = g (= \frac{df}{dt}).$$

Lemma 20 (Diekmann et al.)

$$IE^\odot = \left\{ f : f(t) = f(0^+) + \int_0^t g(\tau)d\tau \text{ for } t > 0, g \in L^1(\mathbb{R}_+) \text{ and } g(\sigma) = 0 \text{ for } \sigma \geq 1 \right\}$$

The space IE^\odot is isometrically isomorphic to $\mathbb{R} \times L^1([0, 1], \mathbb{R})$ equipped with the norm

$$\|(c, g)\| = |c| + \|g\|_{L^1}.$$

Lemma 21 (Diekmann et al.) The semi-group $T_0^\odot(t)$ is given by the formula

$$T_0^\odot(t)(c, g) = \left(c + \int_0^t g(\tau)d\tau, g(t + \cdot) \right).$$

Its generator A_0^\odot verifies

$$D(A_0^\odot) = \{(c, g), g \in AC(\mathbb{R}_+)\}$$

and $A_0^\odot(c, g) = (g(0), \dot{g})$, where $AC(\mathbb{R}_+)$ is the space of absolutely continuous functions on \mathbb{R}_+ . We represent $IE^{\odot*}$ by $\mathbb{R} \times L^\infty([-1, 0], \mathbb{R})$ equipped with the norm

$$\|(\alpha, \varphi)\| = \sup(\alpha, \|\varphi\|_{L^\infty}),$$

and the pairing:

$$\langle (c, g), (\alpha, \varphi) \rangle = c\alpha + \int_{-1}^0 g(\tau)\varphi(\tau)d\tau.$$

Lemma 22 [33] The semi-group $T_0^{\odot*}(t)$ is given by

$$T_0^{\odot*}(t)(\alpha, \varphi) = (\alpha, \varphi_t^\alpha)$$

where

$$\varphi_t^\alpha(s) = \begin{cases} \varphi(t+s) & \text{if } t+s \leq 0, \\ \alpha & \text{if } t+s > 0. \end{cases}$$

Its generator $A_0^{\odot*}$ satisfies

$$D(A_0^{\odot*}) = \{(\alpha, \varphi), \varphi \in Lip(\alpha)\}$$

and

$$A_0^{\odot*}(\alpha, \varphi) = (0, \varphi).$$

Here $Lip(\alpha)$ denotes the subset of $L^\infty(\mathbb{R}_+, \mathbb{R})$ whose elements contain as a class in \mathcal{L}^∞ a Lipschitz continuous function which assumes the value α at $\tau = 0$. Taking the closure of $D(A_0^{\odot*})$, we lose the Lipschitz condition but continuity remains.

Lemma 23 [33]

$$IE^{\odot\odot} = \{(\alpha, \varphi), \varphi \text{ continuous and } \varphi(0) = \alpha\}$$

2.2.2 The general equation. We now consider the equation

$$\frac{dx}{dt} = L(x_t)$$

The equation leads to the following "formal" equation

$$\frac{d(x_t)}{dt} = A_0x_t + X_0L(x_t)$$

The map $X_0 \in \mathbb{E}^{\odot*}$, so if $t \rightarrow x(t)$ is continuous, $t \rightarrow X_0L(x_t)$ is continuous with values in $\mathbb{E}^{\odot*}$. We can then write the following fixed point problem in

$$x_t = T_0(t)x_0 + \int_0^t T_0^{\odot*}(t-s)X_0L(x_s)ds$$

The solution leads to a semigroup $T(t)$ whose generator A is defined by

$$A\varphi = A_0\varphi + X_0L(\varphi)$$

with

$$D(A) = \{\varphi \in D(A_0^{\odot*}) : A_0\varphi + X_0L(\varphi) \in \mathbb{E}\}$$

This corresponds to

$$D(A) = \{\varphi \in C^1, \varphi'(0) = L(\varphi)\}$$

3. Variation Of Constant Formula Using Integrated Semigroups Theory

In [4], [5], and [8] an approach has been developed, based on the theory of integrated semigroups, for establishing a variation of constants formula for functional differential equations in finite dimensional spaces. This approach will be discussed in this section to obtain the variation of constant formula for the following delay differential equations:

$$\begin{cases} \frac{dx}{dt}(t) = L(x_t) + f(t), & t \geq 0, \\ x_0 = \varphi \in \mathcal{C}([-r, 0], \mathbb{R}^n), \end{cases} \quad (3.10)$$

where x_t denotes, as usual, the function defined on $[-r, 0]$ by $x_t(\theta) = x(t + \theta)$, $-\mathbb{R} \leq \theta \leq 0$, L is a continuous linear functional from $\mathcal{C} := \mathcal{C}([-r, 0], \mathbb{R}^n)$ into \mathbb{R}^n and f is a function from $[0, +\infty[$ into \mathbb{R}^n . The initial value problem associated with equation (3.10) is : given $\varphi \in \mathcal{C}$,

to find a continuous function $x : [-\mathbb{R}, h[\rightarrow \mathbb{R}^n$, $h > 0$, differentiable on $[0, h[$, satisfying equation (3.10) on $[0, h[$.

We know that the solutions of the linear autonomous retarded functional differential equation

$$\begin{cases} \frac{dx}{dt}(t) = L(x_t), & t \geq 0, \\ x_0 = \varphi, \end{cases} \quad (3.11)$$

in \mathbb{R}^n , define a strongly continuous translation semigroup $(T(t))_{t \geq 0}$ in the space $\mathcal{C} := \mathcal{C}([-r, 0], \mathbb{R}^n)$. The initial value problem associated with equation (3.10) can be written formally as an integral equation

$$x_t = T(t)\varphi + \int_0^t T(t-s)X_0 f(s)ds, \text{ for } t \geq 0,$$

where X_0 denotes the function defined by $X_0(\theta) = 0$ if $\theta < 0$ and $X_0(0) = Id_{\mathbb{R}^n}$.

The expression $T(\cdot)X_0$ in the integral is not strictly defined, since X_0 is not in \mathcal{C} and $T(\cdot)$ acts on \mathcal{C} . In this paper, we prove that the semigroup $(T(t))_{t \geq 0}$ associated to equation (3.10) can be extended to the space $\mathcal{C} \oplus \langle X_0 \rangle$, where $\langle X_0 \rangle = \{X_0 c, c \in \mathbb{R}^n \text{ and } (X_0 c)(\theta) = X_0(\theta)c\}$ as an integrated semigroup of operators and we derive its consequences regarding the nonhomogeneous linear equation (3.10) and the nonlinear equation

$$\begin{cases} \frac{dx}{dt}(t) = L(x_t) + f(t, x_t), & t \geq 0. \\ x_0 = \varphi \in \mathcal{C}. \end{cases} \quad (3.12)$$

3.1 Notations and basic results

We start by giving some basic terminology, definitions, and results that will be needed in the sequel. The following definitions are due to Arendt.

Definition 20 [9] *Let X be a Banach space. A family $(S(t))_{t \geq 0}$ of bounded linear operators $S(t)$ on X is called an integrated semigroup if the following conditions are satisfied:*

- (i) $S(0) = 0$;
- (ii) for any $x \in X$, $S(t)x$ is a continuous function of $t \geq 0$ with values in X ;

- (iii) for any $t, s \geq 0$ $S(s)S(t) = \int_0^s (S(t+\tau) - S(\tau))d\tau$.

Definition 21 [9] *An integrated semigroup $(S(t))_{t \geq 0}$ is called exponentially bounded, if there exist constants $M \geq 0$ and $\omega \in \mathbb{R}$ such that $\|S(t)\| \leq Me^{\omega t}$ for all $t \geq 0$. Moreover $(S(t))_{t \geq 0}$ is called non-degenerate, if $S(t)x = 0$, for all $t \geq 0$, implies that $x = 0$.*

If $(S(t))_{t \geq 0}$ is an integrated semigroup exponentially bounded, then the Laplace transform $R(\lambda) := \lambda \int_0^{+\infty} e^{-\lambda t} S(t) dt$ exists for all λ with $\Re e(\lambda) > \omega$, but $R(\lambda)$ is injective if and only if $(S(t))_{t \geq 0}$ is non-degenerate. In this case $R(\lambda)$ satisfies the following expression

$$R(\lambda) - R(\mu) = (\mu - \lambda)R(\lambda)R(\mu),$$

and there exists a unique operator A satisfying $(\omega, +\infty) \subset \rho(A)$ (the resolvent set of A) such that

$$R(\lambda) = (\lambda I - A)^{-1}, \text{ for all } \Re e(\lambda) > \omega.$$

The operator A is called the generator of $(S(t))_{t \geq 0}$. We have the following definition.

Definition 22 [9] *An operator A is called a generator of an integrated semigroup, if there exists $\omega \in \mathbb{R}$ such that $]\omega, +\infty[\subset \rho(A)$, and there exists a strongly continuous exponentially bounded family $(S(t))_{t \geq 0}$ of linear bounded operators such that $S(0) = 0$ and $(\lambda I - A)^{-1} = \lambda \int_0^{+\infty} e^{-\lambda t} S(t) dt$ for all $\lambda > \omega$.*

Proposition 26 [9] *Let A be the generator of an integrated semigroup $(S(t))_{t \geq 0}$. Then for all $x \in X$ and $t \geq 0$*

$$\int_0^t S(s)x ds \in D(A) \text{ and } S(t)x = A \left(\int_0^t S(s)x ds \right) + tx.$$

An important special case is when the integrated semigroup is locally Lipschitz, continuous..

Definition 23 [9] *An integrated semigroup $(S(t))_{t \geq 0}$ is called locally Lipschitz continuous if, for all $\tau > 0$, there exists a constant $k(\tau) > 0$ such that*

$$\|S(t) - S(s)\| \leq k(\tau) |t - s|, \text{ for all } t, s \in [0, \tau].$$

From [9], we know that every locally Lipschitz continuous integrated semigroup is exponentially bounded.

Definition 24 [9] *We say that a linear operator A satisfies the Hille-Yosida (HY) condition, if there exists $M > 0$ and $\omega \in \mathbb{R}$ such that $]\omega, +\infty[\subset \rho(A)$ and*

$$\sup \{ (\lambda - \omega)^n \|(\lambda I - A)^{-n}\|, n \in \mathbf{N}, \lambda > \omega \} \leq M.$$

The following theorem shows that the Hille-Yosida condition characterizes generators of locally Lipschitz continuous integrated semigroups.

Theorem 3 [9] *The following assertions are equivalent.*

- (i) *A is the generator of a non-degenerate, locally Lipschitz continuous integrated semigroup,*
- (ii) *A satisfies the (HY) condition .*

In the sequel, we give some results for the existence of particular solutions of the following Cauchy problem

$$\begin{cases} \frac{du}{dt}(t) = Au(t) + f(t), & t \geq 0, \\ u(0) = x \in X, \end{cases} \tag{3.13}$$

where A satisfies the (HY) condition.

Definition 25 [32] *Given $f \in L^1_{loc}(0, +\infty; X)$ and $x \in X$, we say that $u : [0, +\infty[\rightarrow X$ is an integral solution of the equation (3.13) if the following assertions are true*

- (i) $u \in \mathcal{C}([0, +\infty[; X)$
- (ii) $\int_0^t u(s)ds \in D(A)$, for $t \geq 0$,
- (iii) $u(t) = x + A \int_0^t u(s)ds + \int_0^t f(s)ds$, for $t \geq 0$.

From this definition, we deduce that for an integral solution u , we have $u(t) \in \overline{D(A)}$, for all $t > 0$, because $u(t) = \lim_{h \rightarrow 0} \frac{1}{h} \int_t^{t+h} u(s)ds$ and $\int_t^{t+h} u(s)ds \in D(A)$. In particular, $x \in \overline{D(A)}$ is a necessary condition for the existence of an integral solution of (3.13).

Theorem 4 [22] *Suppose that A satisfies the (HY) condition, $x \in \overline{D(A)}$ and $f : [0, +\infty[\rightarrow X$ is a continuous function. Then the problem (3.13) has a unique integral solution which is given by*

$$u(t) = S'(t)x + \frac{d}{dt} \int_0^t S(t-s)f(s)ds, \text{ pour } t \geq 0,$$

where $S(t)$ is the integrated semigroup generated by A . Moreover u satisfies

$$|u(t)| \leq Me^{\omega t}(|x| + \int_0^t e^{-\omega s} |f(s)| ds), \text{ for } t \geq 0.$$

3.2 The variation of constant formula

Let L be a linear bounded operator from \mathcal{C} into \mathbb{R}^n . We consider the linear functional differential equation (3.11). The following result is known.

Theorem 5 [48] *The operator $A\varphi = \varphi'$ with domain*

$$D(A) = \{ \varphi \in \mathcal{C}^1([-r, 0]; \mathbb{R}^n), \quad \varphi'(0) = L(\varphi) \}$$

is the infinitesimal generator of a strongly continuous semigroup $(T(t))_{t \geq 0}$ on \mathcal{C} satisfying the translation property

$$(T(t)\varphi)(\theta) = \begin{cases} \varphi(t + \theta) & \text{if } t + \theta \leq 0 \\ (T(t + \theta)\varphi)(0) & \text{if } t + \theta > 0, \end{cases}$$

$t \geq 0, \theta \in [-r, 0], \varphi \in \mathcal{C}$.

Furthermore, for each $\varphi \in \mathcal{C}$, define $x : [-r, +\infty[\rightarrow \mathbb{R}^n$ by

$$x(t) = \begin{cases} \varphi(t) & \text{if } t \in [-r, 0] \\ (T(t)\varphi)(0) & \text{if } t > 0. \end{cases}$$

Then x is the unique solution of (3.11) and $T(t)\varphi = x_t$, for $t \geq 0$.

For each complex number λ , we define the bounded linear operator $L_\lambda : \mathbb{R}^n \rightarrow \mathbb{R}^n$ by

$$L_\lambda(c) = L(e^{\lambda \cdot} c), \text{ for } c \in \mathbb{R}^n,$$

where $e^{\lambda \cdot} c : [-r, 0] \rightarrow \mathbb{R}^n$ is defined by

$$(e^{\lambda \cdot} c)(\theta) = e^{\lambda \theta} c, \quad \theta \in [-r, 0].$$

We know, from [48] that the resolvent set $\rho(A)$ of A is given by

$$\rho(A) = \{ \lambda \in \mathbf{C}, \quad \Delta(\lambda)^{-1} \text{ exists in } \mathcal{L}(\mathbb{R}^n) \},$$

where $\mathcal{L}(\mathbb{R}^n)$ is the space of linear bounded operators on \mathbb{R}^n and $\Delta(\lambda) = \lambda I - L_\lambda$.

We now present our first main result.

Theorem 6 *The continuous extension \tilde{A} of the operator A to the space $\mathcal{C} \oplus \langle X_0 \rangle$, defined by*

$$D(\tilde{A}) = \mathcal{C}^1([-r, 0], \mathbb{R}^n), \text{ and } \tilde{A}\varphi = \varphi' + X_0(L(\varphi) - \varphi'(0)),$$

generates a locally Lipschitz continuous integrated semigroup $(S(t))_{t \geq 0}$ on $\mathcal{C} \oplus \langle X_0 \rangle$ such that $S(t)(\mathcal{C} \oplus \langle X_0 \rangle) \subset \mathcal{C}$ and $S(t)\varphi = \int_0^t T(s)\varphi ds$, for $\varphi \in \mathcal{C}$.

It suffices to show that \tilde{A} satisfies the (HY) condition .

By the Hille-Yosida theorem, there exists $\omega \in \mathbb{R}$, such that:

$$\sup_{n \in \mathbb{N}, \lambda > \omega} \left\{ \rho(A) \supset (\omega, +\infty) \right. \\ \left. \{(\lambda - \omega)^n \|R(\lambda, A)^n\|\} < +\infty \right.$$

where $R(\lambda, A) = (\lambda I - A)^{-1}$. In particular, for $\lambda > \omega$, $\Delta(\lambda)$ is invertible on $\mathcal{L}(\mathbb{R}^n)$.

We need the following lemma.

Lemma 24 *For $\lambda > \omega$,*

(i) $D(\tilde{A}) = D(A) \oplus \langle e^{\lambda \cdot} \rangle$, where $\langle e^{\lambda \cdot} \rangle = \{e^{\lambda \cdot} c; \quad c \in \mathbb{R}^n\}$,

(ii) $(\omega, +\infty) \subset \rho(\tilde{A})$ and for $n \geq 1$

$$R(\lambda, \tilde{A})^n(\varphi + X_0 c) = R(\lambda, A)^n \varphi + R(\lambda, A)^{n-1} \left(e^{\lambda \cdot} \Delta^{-1}(\lambda) c \right),$$

for every $(\varphi, c) \in \mathcal{C} \times \mathbb{R}^n$.

Proof of lemma. We consider the following operator

$$l : D(\tilde{A}) \rightarrow \mathbb{R}^n \\ \psi \rightarrow l(\psi) = \psi'(0) - L(\psi).$$

Let $\tilde{\psi} \in D(\tilde{A})$ and $\lambda > \omega$. If we put $\psi = \tilde{\psi} - e^{\lambda \cdot} \Delta(\lambda)^{-1} l(\tilde{\psi})$, then we deduce that $\psi \in \text{Ker}(l) = D(A)$, and the decomposition $\tilde{\psi} = \psi + e^{\lambda \cdot} a$, with $a \in \mathbb{R}^n$, is unique.

Let $\tilde{\varphi} \in \mathcal{C} \oplus \langle X_0 \rangle$, $\tilde{\varphi} = \varphi + X_0 c$. We look for $\tilde{\psi} \in D(\tilde{A})$, such that $(\lambda I - \tilde{A})\tilde{\psi} = \tilde{\varphi}$.

$\tilde{\psi}$ can be written as $\tilde{\psi} = \psi + e^{\lambda \cdot} a$, where $\psi \in D(A)$ and $a \in \mathbb{R}^n$.

We have

$$(\lambda I - \tilde{A})(\psi + e^{\lambda \cdot} a) = \varphi + X_0 c.$$

This equation splits into two

$$\begin{cases} (\lambda I - A)\psi = \varphi \\ \Delta(\lambda)a = c. \end{cases}$$

It follows that for $\lambda > \omega$, $(\lambda I - \tilde{A})^{-1}$ exists and

$$(\lambda I - \tilde{A})^{-1}(\varphi + X_0 c) = (\lambda I - A)^{-1}\varphi + e^{\lambda \cdot} \Delta(\lambda)^{-1} c.$$

Repeating this procedure, we have for every $n \geq 1$

$$R(\lambda, \tilde{A})^n(\varphi + X_0 c) = R(\lambda, A)^n \varphi + R(\lambda, A)^{n-1} \left(e^{\lambda \cdot} \Delta^{-1}(\lambda) c \right). \quad (3.14)$$

This completes the proof of the lemma.

On the other hand, one has

$$\Delta(\lambda) = \lambda I - L_\lambda = \lambda \left(I - \frac{1}{\lambda} L_\lambda \right).$$

Without loss of generality, we can assume that $\lambda > 0$, in this case, we have

$$\left\| \frac{1}{\lambda} L_\lambda \right\| \leq \frac{\|L\|}{\lambda} < 1, \text{ for } \lambda > \|L\|.$$

Hence the operator $I - \frac{1}{\lambda} L_\lambda$ is invertible and

$$\left(I - \frac{1}{\lambda} L_\lambda \right)^{-1} = \sum_{n \geq 0} \frac{1}{\lambda^n} L_\lambda^n.$$

So,

$$\left\| \left(I - \frac{1}{\lambda} L_\lambda \right)^{-1} \right\| \leq \frac{1}{1 - \frac{1}{\lambda} \|L\|},$$

and

$$\|\Delta^{-1}(\lambda)\| \leq \frac{1}{\lambda - \|L\|}, \text{ for } \lambda > \max(\|L\|, \omega).$$

Using the relation (3.14), we obtain

$$\sup_{n \in \mathbf{N}, \lambda > \omega_0} \left\| (\lambda - \omega_0)^n R(\lambda, \tilde{A})^n \right\| < \infty, \text{ where } \omega_0 = \max(\|L\|, \omega).$$

We conclude by theorem 3, that \tilde{A} is the generator of a locally Lipschitz continuous integrated semigroup.

Now, consider the nonhomogeneous functional differential equation (3.10)

$$\begin{cases} \frac{dx}{dt}(t) = L(x_t) + f(t), \text{ for } t \geq 0 \\ x_0 = \varphi \in \mathcal{C}, \end{cases}$$

and the nonhomogeneous associated Cauchy problem

$$\begin{cases} \frac{du}{dt}(t) = \tilde{A}u(t) + X_0f(t), & \text{for } t \geq 0 \\ u(0) = \varphi \in \mathcal{C}. \end{cases} \quad (3.15)$$

Theorem 7 *If $f \in \mathcal{C}([0, +\infty[, \mathbb{R}^n)$, then equation (3.10) has a unique solution x on $[-r, +\infty[$ which is given by*

$$x_t = T(t)\varphi + \frac{d}{dt} \left(\int_0^t S(t-s)X_0f(s)ds \right), \quad \text{for } t \geq 0. \quad (3.16)$$

Proof. It suffices to show that the function u defined by

$$u(t) = x_t, \quad \text{for } t \geq 0, \quad (3.17)$$

is an integral solution of equation (3.15).

Let x be the solution of (3.10), such that $x_0 = \varphi$.

By using the relation

$$\frac{d}{d\theta} \left(\int_0^t x_s ds \right) = x_t - \varphi,$$

we deduce that

$$\tilde{A} \left(\int_0^t x_s ds \right) = x_t - \varphi + X_0 \left(L \left(\int_0^t x_s ds \right) - x(t) + \varphi(0) \right).$$

On the other hand, integrating equation (3.10) from 0 to t , we get

$$x(t) = \varphi(0) + L \left(\int_0^t x_s ds \right) + \int_0^t f(s) ds.$$

It follows that

$$u(t) = \varphi + \tilde{A} \left(\int_0^t u(s) ds \right) + X_0 \int_0^t f(s) ds.$$

We obtain that u is an integral solution of (3.15).

The operator \tilde{A} satisfies the (HY) condition. So this solution can be written as

$$u(t) = T(t)\varphi + \frac{d}{dt} \left(\int_0^t S(t-s)X_0f(s)ds \right), \quad \text{for } t \geq 0.$$

Consider the nonlinear equation

$$\begin{cases} \frac{dx}{dt}(t) = L(x_t) + f(t, x_t), & \text{for } t \geq 0 \\ x_0 = \varphi, \end{cases} \quad (3.18)$$

and the initial value problem associated

$$\begin{cases} \frac{du}{dt}(t) = \tilde{A}u(t) + X_0f(t, u(t)), \text{ for } t \geq 0 \\ u(0) = \varphi, \end{cases} \quad (3.19)$$

where $f : [0, +\infty[\times \mathcal{C} \rightarrow \mathbb{R}^n$ is Lipschitz with respect to the second variable and continuous.

We know that equation (3.18) has one and only one solution x which is defined on $[-r, +\infty[$ by

$$x(t) = \varphi(0) + L\left(\int_0^t x_s ds\right) + \int_0^t f(s, x_s) ds, \text{ for } t \geq 0.$$

Substituting $f(t, x_t)$ for $f(t)$ in formula 3.16, equation (3.18) can be written as a fixed point equation.

We deduce the following result.

Theorem 8 *Under the above conditions, the solution x of equation (3.18) can be written as*

$$x_t = T(t)\varphi + \frac{d}{dt} \left(\int_0^t S(t-s)X_0f(s, x_s) ds \right), \text{ for } t \geq 0.$$

Appendix

In this section, we prove that the integrated semigroup $(S(t))_{t \geq 0}$ associated to the equation (3.11) can be written as a perturbation of the integrated semigroup $(S_0(t))_{t \geq 0}$ associated to the trivial equation

$$\begin{cases} \frac{dx}{dt}(t) = 0, \quad \text{for } t > 0, \\ x_0 = \varphi \in \mathcal{C}. \end{cases} \quad (3.20)$$

The generator A_0 of the C_0 -semigroup associated to equation (3.20) is given by

$$D(A_0) = \{ \varphi \in \mathcal{C}^1; \quad \varphi'(0) = 0 \}, \text{ and } A_0\varphi = \varphi'.$$

By theorem 6, we obtain:

Corollary 9 *The continuous extension \tilde{A}_0 of the operator A_0 defined on $\mathcal{C} \oplus \langle X_0 \rangle$ by*

$$D(\tilde{A}_0) = \mathcal{C}^1([-r, 0], \mathbb{R}^n), \text{ and } \tilde{A}_0\varphi = \varphi' - X_0\varphi'(0),$$

generates a locally Lipschitz continuous integrated semigroup $(S_0(t))_{t \geq 0}$ on

$\mathcal{C} \oplus \langle X_0 \rangle$ such that $S_0(t)(\mathcal{C} \oplus \langle X_0 \rangle) \subset \mathcal{C}$ and $S_0(t)\varphi = \int_0^t T_0(s)\varphi ds$, for $\varphi \in \mathcal{C}$.

Theorem 10 *The integrated semigroup $(S(t))_{t \geq 0}$ associated with equation (3.11) is given by*

$$S(t)\varphi = S_0(t)\varphi + \int_0^t S_0(t-s)X_0L(T(s)\varphi)ds, \quad t \geq 0 \text{ and } \varphi \in \mathcal{C}.$$

Proof. For every function $\varphi \in \mathcal{C}$, consider the nonhomogeneous Cauchy problem

$$\begin{cases} \frac{du}{dt}(t) = \tilde{A}_0 u(t) + h(t), & \text{for } t \geq 0 \\ u(0) = 0, \end{cases} \quad (3.21)$$

where $h : [0, +\infty[\rightarrow \mathcal{C} \oplus \langle X_0 \rangle$ is given by

$$h(t) = \varphi + X_0(L(S(t)\varphi)).$$

In view of corollary 9, \tilde{A}_0 satisfies the (HY) condition. Hence, by theorem 4 the nonhomogeneous Cauchy problem (3.21) has an integral solution u given by

$$u(t) = \frac{d}{dt} \left(\int_0^t S_0(t-s)h(s)ds \right), \quad \text{for } t \geq 0.$$

On the other hand, we have

$$S(t)\varphi = \tilde{A} \left(\int_0^t S(s)\varphi ds \right) + t\varphi.$$

This implies that

$$\frac{d}{dt} \left(\int_0^t S(s)\varphi ds \right) = S(t)\varphi - t\varphi, \quad \text{for } \varphi \in \mathcal{C}.$$

By applying

$$\tilde{A}\psi = \tilde{A}_0\psi + X_0(L(\psi)), \quad \text{for } \psi \in \mathcal{C}^1,$$

we obtain

$$S(t)\varphi = \tilde{A}_0 \left(\int_0^t S(s)\varphi ds \right) + X_0 \left(\int_0^t L(S(s)\varphi) ds \right) + t\varphi,$$

so,

$$S(t)\varphi = \tilde{A}_0 \left(\int_0^t S(s)\varphi ds \right) + \int_0^t h(s)ds.$$

Hence, the function $t \rightarrow S(t)\varphi$ is an integral solution of (3.21). By uniqueness, we conclude that $S(t)\varphi = u(t)$, for all $t \geq 0$.

Consequently,

$$S(t)\varphi = S_0(t)\varphi + \frac{d}{dt} \left(\int_0^t S_0(t-s)X_0(L(S(s)\varphi) ds \right).$$

We deduce that

$$S(t)\varphi = S_0(t)\varphi + \frac{d}{dt} \left(\int_0^t S_0(s)X_0(L(S(t-s)\varphi)ds \right),$$

and

$$S(t)\varphi = S_0(t)\varphi + \int_0^t S_0(t-s)X_0(L(S(s)\varphi)ds.$$

Remark: 1) All results of this section can be obtained if we consider the following abstract functional differential equation

$$\begin{cases} \frac{dx}{dt}(t) = Bx(t) + L(x_t) + f(t), & t \geq 0, \\ x_0 = \varphi, \end{cases} \quad (3.22)$$

where B is generator infinitesimal of C_0 semigroup $(T(t))_{t \geq 0}$ on a Banach space E .

2) The approach developed in the first section, based on a certain class of weakly * continuous semigroups on a dual Banach space (see Clement et al.) ([27]), for the study of delay differential equations in finite dimensional spaces cannot be used in infinite dimensional spaces because we do not have necessarily $\mathcal{C}^{\odot\odot} \simeq \mathcal{C}$.

Chapter 5

INTRODUCTION TO HOPF BIFURCATION THEORY FOR DELAY DIFFERENTIAL EQUATIONS

M.L. Hbid

University Cadi Ayyad , Marrakech, Morocco.

hbid@ucam.ac.ma

1. Introduction

1.1 Statement of the Problem:

Consider the family of equations:

$$G(\alpha, x) = 0 \tag{1.1}$$

where $x \in X$, $\alpha \in \Lambda$, $G : \Lambda \times X \rightarrow X$; X is a Banach space; Λ

is a topological space of parameters. Suppose that equation (1.1) has for each α , a root translated to the origin $x = 0$, qualified as a trivial solution, that we have $G(\alpha, 0) = 0$ for each $\alpha \in \Lambda$.

The problem here is to determine non trivial solutions of (1.1).

Definition 26 *We say that $(\alpha_0, 0)$ is a bifurcating point of solutions of (1.1) if each neighborhood of $(\alpha_0, 0)$ in $\Lambda \times X$ contains a point (α, x) satisfying $x \neq 0$ and $G(\alpha, x) = 0$.*

Definition 27 *A bifurcation branch emanating from $(\alpha_0, 0)$ is a map b defined from the interval $I = [0, a[\subset \mathbb{R}$ into $\Lambda \times X$ such that $b : s \rightarrow b(s) = (\alpha(s), x(s))$ satisfying $x(s) \neq 0$ for $s \neq 0$, $\lim_{s \rightarrow 0} x(s) = 0$, $\lim_{s \rightarrow 0} \alpha(s) = \alpha_0$, and $G(\alpha(s), x(s)) = 0$.*

- The graph of the map b is also called the bifurcating branch (or branch of bifurcation).

- $\Lambda \times \{0\}$ is the trivial branch.

- A bifurcation method is any method that could be used to exhibit a branch of bifurcation for a family of equations.

Bifurcation theory studies persistence and exchange of qualitative properties of dynamical systems under continuous perturbations. A typical case, which we will present here, is the case of systems depending continuously on a single parameter. We will deal with retarded differential equations of the form

$$\frac{dx(t)}{dt} = F(\alpha, x_t) \quad (1.2)$$

with $F : \mathbb{R} \times C \rightarrow \mathbb{R}^n$, F of class C^2 and $F(\alpha, 0) = 0 \forall \alpha \in \mathbb{R}$ and $C = C([-r, 0], \mathbb{R}^n)$ the space of continuous functions from $[-r, 0]$ into \mathbb{R}^n . As usual, x_t is the function defined from $[-r, 0]$ into \mathbb{R}^n by $x_t(\theta) = x(t + \theta)$, $r \geq 0$ (r could be infinite).

We will be concerned with the nature of the equilibrium point 0 (stable or unstable) with respect to the values of the parameter α . What happens if at such a point α_0 , we observe a change in the stability (that is to say, a **transition** from stability to instability when the system crosses the value of the parameter α_0).

Such a change may in fact correspond to important changes of the dynamics.

Examples of systems depending on a parameter are abundant in physics, chemistry, biology and...etc. Parameters can be the temperature, resistance, reaction rate or the mortality rate, the birth rate, etc. Under small variations of the parameter, such systems may lose stability, more precisely, the "trivial" equilibrium may lose stability, and restabilize near another equilibrium or a closed orbit or a larger attractor. The transition can be continuous, gentle and smooth, with the new equilibrium state emerging in the vicinity of the "trivial" one, or it can be of a discontinuous nature, with the new equilibrium being far from the "trivial" one. The first case corresponds to a local bifurcation, the second one is a global bifurcation.

In local bifurcations, one can distinguish two types of bifurcations:

I) the system leaves its equilibrium state and reaches a new fixed equilibrium state.

II) the system goes from an equilibrium state to an invariant subset made generally of several equilibriums and curves connecting them, closed orbits, or tori, etc. The most elementary situation is the Hopf bifurcation, characterized by the onset of a closed orbit, starting near the trivial equilibrium, which is the phase portrait of a periodic solution with period close to some fixed number (Hopf 1942).

In this course, we will restrict our attention to Hopf bifurcation.

Definition 28 $(\alpha_0, 0) \in \mathbb{R} \times C$ is said to be a Hopf bifurcation point for equation (1.2) if every neighbourhood of this point in $\mathbb{R} \times C$ contains a point (α, φ) , with $\varphi \neq 0$ such that φ is the initial data of a periodic solution, with period near a fixed positive number, of equation (1.2) for the value of the parameter α .

We will now make the following assumptions:

(H_0) F is of class C^k , for $k \geq 2$, $F(\alpha, 0) = 0$ for each α , and the map $(\alpha, \varphi) \rightarrow D_\varphi^k F(\alpha, \varphi)$ sends bounded sets into bounded sets.

(H_1) The characteristic equation

$$\det \Delta(\alpha, \lambda) := \lambda Id - D_\varphi F(\alpha, 0) \exp(\lambda(\cdot) Id) \tag{1.3}$$

of the linearized equation of (1.2) around the equilibrium $v = 0$:

$$\frac{dv(t)}{dt} = D_\varphi F(\alpha, 0)v_t \tag{1.4}$$

has in $\alpha = \alpha_0 \geq 0$ a simple imaginary root $\lambda_0 = \lambda(\alpha_0) = i$, all the others roots λ satisfy $\lambda \neq m\lambda_0$ for $m = 0, \pm 2, \pm 3, \pm 4, \dots$

$((H_1)$ implies notably that the root λ_0 lies on a branch of roots $\lambda = \lambda(\alpha)$ of equation (1.3), of class C^{k-1})

(H_2) $\lambda(\alpha)$ being the branch of roots passing through λ_0 , we have

$$\frac{\partial}{\partial \alpha} \Re e \lambda(\alpha) |_{\alpha=\alpha_0} \neq 0 \tag{1.5}$$

Theorem 1 Under the assumptions (H_0) , (H_1) and (H_2) , there exist constants $R, \delta > 0$, and $\eta > 0$ and functions $\alpha(c), \omega(c)$ and a periodic function with period $\omega(c), u^*(c)$, such that a) All of these functions are of class C^1 with respect to c , for $c \in [0, R], \alpha(0) = \alpha_0, \omega(0) = \omega_0, u^*(0) = 0$; b) $u^*(c)$ is a periodic solution of (1.2), for the parameter value equal $\alpha(c)$ and period $\omega(c)$; c) For $|\alpha - \alpha_0| < \delta$ and $|\omega - 2\pi| < \eta$, any ω -periodic solution p , with $\|p\| < R$, of (1.2) for the parameter value α , there exists $c \in [0, R[$ such $\alpha = \alpha(c), \omega = \omega(c)$ and p is, up to a phase shift, equal to $u^*(c)$.

1.2 History of the problem

1.2.1 The Case of ODEs:. A bifurcation result similar to theorem1 was first established by Hopf (Hopf (1942), Abseiwigung einer periodischen lösung eines differential systems. Berichen Math. Phys. Ki. Säch. Akad. Wiss Leipzig 94, 1-22) in the case of ODE, assuming that the function is analytic with respect to both the state variable and the parameter. Hopf obtained $\alpha(c), \omega(c)$ and $u^*(c)$ analytic in c at 0.

In the seventies, Hsu and Kazarinoff, Poore, Marsden and McCracken (1976) and others discuss in their works the computation of important features of the Hopf bifurcation, especially the direction of bifurcation and dynamical aspects (stability, attractiveness, etc), both from theoretical and numerical standpoints. A very important new achievement was the proof by Alexander and Yorke of what is known as the global Hopf bifurcation theorem, which roughly speaking describes the extent of the branch. The theory was also extended towards allowing further degeneracies (more than two eigenvalues crossing the imaginary axis, or multiplicity higher than one, etc) leading notably to the development of the generalized Hopf bifurcation theory (Bernfeld et al (1980, 1982), Negrini and Salvadori (1978), M.L. Hbid (Thèse de Doctorat 1987)).

After the work done in the seventies, one might consider that the Hopf bifurcation theory for ODEs is essentially closed (proof of theorem of existence of periodic solutions, computation of direction of bifurcation, estimation of elements of bifurcation, stability of the bifurcating branch).

1.2.2 The case of Delay Equations:. - Chafee in 1971 was the first to prove the local Hopf bifurcation theorem for DDE. Chafee's theorem gives both existence and stability: for this, it is necessary to make further assumptions in addition to the extension of the conditions stated in the Hopf bifurcation theorem for ODEs. The first proof of a *stricto sensu* extension of the Hopf bifurcation theorem to DDE is attributed, in historical notes of Hale's book, to Chow and Mallet-Paret (1974). It is probably right to say that the machinery, at the functional analytic level, that was necessary for such an extension, was there, ready to be used, by the beginning of the seventies, and was indeed used independently by several groups, here and there. I will now quote some of the work done starting in the mid-seventies. This list should not be considered exhaustive in whatever way:

- Hale in his book (1977) gives a proof of the theorem (1), based on some of his earlier work in the case of ODE.

- Chow and Mallet-Paret (1978) use the averaging method to determine the stability and the amplitude of the bifurcating periodic orbit.

- Arino (1980) (not published) discusses one of the issues entailed by DDEs, namely a lack of regularity when the parameter is the delay. This problem shows up notably in the fixed point formulation for the determination of periodic solutions. The method elaborated in Arino (1980) goes through the adaptation of the implicit function theorem.

- Schumacher (1982) proves the Hopf bifurcation theorem for a strongly continuous nonlinear semigroup defined in a closed subset of a Banach space.

- Stech (1985) uses the Lyapunov-Schmidt reduction method and generalizes a proof given by De Oliveira and Hale (1980) in the case of ODEs to infinite delay differential equations. He also gives a computational scheme of bifurcation elements via an asymptotic expansion of the bifurcation function.

- Staffans (1987) shows the theorem in a case analogous to Stech's in the case of neutral functional differential equations. His method is based on the Lyapunov -Schmidt reduction method.

- Diekmann and van Gils (1990) reformulate the problem as an integral equation. Using the theory of perturbation by duality, these authors prove a centre manifold theorem for DDE and deduce the existence of bifurcating periodic solutions via a reduction on centre manifold.

- Adimy (1991) proves the Hopf bifurcation theorem using the integrated semigroup theory.

- Talibi (1992) uses an approximation method to obtain the existence of periodic solutions.

- M.L. Hbid (1993) uses a reduction principle to a centre manifold, the Lyapunov direct method and the Poincaré procedure to prove the theorem.

- T.Faria and L.Magalhaes (1995) extend the normal form theory to DDE and apply the theory to Hopf bifurcations of such equations.

In a more recent past, the Hopf bifurcation theory has been considered in the case of functional partial differential equations, delay differential equations in infinite dimensional spaces. This subject will be presented in T.Faria's lectures. The theory has also been extended to the case of differential equations with state-dependent delay.

The following statement of the local Hopf bifurcation theorem is given by J.Hale

Theorem 2 (*J.K. Hale, Theory of functional differential equations, 1977*)
 Suppose $F(\alpha, \phi)$ has continuous first and second derivatives with respect to α, ϕ , $F(\alpha, 0) = 0$ for all α , and Hypothesis (H_1) and (H_2) are satisfied. Then there are constants $a_0 > 0$, $\alpha_0 > 0$, $\delta_0 > 0$, functions $\alpha(a) \in \mathbb{R}$, $\omega(a) \in \mathbb{R}$, and an $\omega(a)$ - periodic function $x^*(a)$, with all functions being continuously differentiable in a for $|a| < a_0$, such that $x^*(a)$ is a solution of equation (1.2) with

$$x_0^*(a)^{N_\alpha} = \Phi_{\alpha(a)} y^*(a), \quad x_0^*(a)^{Q_\alpha} = z_0^*(a) \quad (1.6)$$

where $y^*(a) = (a, 0)^T + o(|a|)$, $z_0^*(a) = o(|a|)$ as $|a| \rightarrow 0$. Furthermore, for $|\alpha|$ near 0 and $|\omega - 2\pi| < \delta_0$, every ω - periodic solution of equation (1.2) with $|x_t| < \delta_0$ must be of the type exact for a translation in phase.

The approach we want to illustrate is based on two steps: first, a reduction to a centre manifold, where the DDE reduces to an ODE; then, the study of the bifurcation of periodic solutions on the reduced system. For the reduction, we have followed the approach of Diekmann and van Gils (1991), which itself is an adaptation to DDE of a method originally proposed by Vanderbauwhede in the context of ODE. Once reduction has been obtained, one has the problem of investigating the dynamics near a critical point: nonlinearities play a crucial role there, and the difficulty lies in the fact that the nonlinearities are only known implicitly. The method we present here consists in computing a Lyapunov function using the Poincaré procedure.

2. The Lyapunov Direct Method And Hopf Bifurcation: The Case Of Ode

Before discussing the behavior of the reduced ordinary differential system (3.28), let us recall the framework of the generalized Hopf bifurcation and h-asymptotic stability related to the Poincaré procedure (see [14],[21][20]). We consider the planar system of differential equations

$$\begin{cases} \frac{dx_1}{dt} = \alpha(\mu)x_1 - \beta(\mu)x_2 + R_1(\mu, x_1, x_2) \\ \frac{dx_2}{dt} = \alpha(\mu)x_2 - \beta(\mu)x_1 + R_2(\mu, x_1, x_2) \end{cases} \tag{2.7}$$

$\alpha(\mu), \beta(\mu) \in C^{k+1}]-\bar{\mu}, \bar{\mu}[, \mathbb{R}$ and $R_1, R_2 \in C^{k+1} ((-\bar{\mu}, \bar{\mu}) \times B^2(a), \mathbb{R})$ with k integer $k \geq 3$ such that $\alpha(0) = 0, \beta(0) = 1$ and $\frac{d\alpha(0)}{d\mu} \neq 0, R_1(\mu, 0, 0) = R_2(\mu, 0, 0) = 0$ and $D_x R_1(\mu, 0, 0) = D_x R_2(\mu, 0, 0) = 0$

Introducing polar coordinates $x_1 = \rho \cos \theta, x_2 = \rho \sin \theta$, we have

$$\begin{cases} \frac{d\rho}{dt} = \alpha(\mu)\rho + R_1^*(\mu, \rho, \theta) \cos \theta + R_2^*(\mu, \rho, \theta) \sin \theta \\ \frac{\rho d\theta}{dt} = \beta(\mu)\rho + R_2^*(\mu, \rho, \theta) \cos \theta - R_1^*(\mu, \rho, \theta) \sin \theta \end{cases} \tag{2.8}$$

where $R_{1,2}^*(\mu, \rho, \theta) = R_{1,2}(\mu, \rho \cos \theta, \rho \sin \theta)$

Let

$$\begin{cases} W(\mu, \rho, \theta) = \beta(\mu) + \frac{R_2^*(\mu, \rho, \theta) \cos \theta - R_1^*(\mu, \rho, \theta) \sin \theta}{\rho} \\ W(\mu, 0, \theta) = \beta(\mu) \end{cases} \tag{2.9}$$

For every $\rho_0 \in [0, a[$, $\theta_0 \in \mathbb{R}$, the orbit of (2.7) passing through (ρ_0, θ_0) will be represented by the solution $\rho(\theta, \mu_0, \theta_0, \rho_0)$ of the problem

$$\begin{cases} \frac{d\rho}{d\theta} = \frac{\alpha(\mu) + R_1^*(\mu, \rho, \theta) \cos \theta - R_2^*(\mu, \rho, \theta) \sin \theta}{W(\mu, \rho, \theta)} = R(\mu, \rho, \theta) \\ \rho(\mu, \theta_0) = \rho_0 \end{cases} \tag{2.10}$$

When the function $\rho(\theta, \mu_0, \theta_0, \rho_0)$ has been determined, complete information of the solution of (2.7) will be obtained by integrating the following equation

$$\begin{cases} \frac{d\theta}{dt} = W(\mu, \rho(\theta, \mu_0, \theta_0, \rho_0), \theta) \\ (\mu, \rho, \theta) \in]-\bar{\mu}, \bar{\mu}[\times [0, a[\times [0, 2\pi] \end{cases} \tag{2.11}$$

Since $\alpha(0) = 0$, it is easily seen by (2.9) and (2.10) that when $\bar{a} \in [0, a[$ and $\bar{\mu}$ are sufficiently small, then for any $\mu \in]-\bar{\mu}, \bar{\mu}[$ and $c \in [0, \bar{a}[$ the solution of (2.11) exists in $[0, 2\pi]$. This solution will be denoted by $\rho(\theta, \mu, c)$

Definition 29 [21] *The function $V(\mu, c) = \rho(\theta, \mu, c) - c$ is called a displacement function of (2.7).*

For $\mu = 0$, system (2.7) can be written in the form:

$$\begin{cases} \frac{dx_1}{dt} = -x_2 + f_1(x_1, x_2) \\ \frac{dx_2}{dt} = x_1 + f_2(x_1, x_2) \end{cases} \tag{2.12}$$

where $f_i(x_1, x_2) = R_i(0, x_1, x_2)$ $i = 1, 2$ (R_1 and R_2 are introduced in formula (2.7).

Definition 30 [21] *Let h be an integer, $h \geq 3$. The solution $x_1 = x_2 = 0$ of (2.12) is said to be h -asymptotically stable (resp. h -completely unstable) if*

i) For every $\Theta, \Sigma \in C(B^2(a), \mathbb{R})$ of order greater than h in (x_1, x_2) , the solution $x_1 = x_2 = 0$ of the system

$$\begin{cases} \frac{dx_1}{dt} = -x_2 + f_{12}(x_1, x_2) + \dots + f_{1h}(x_1, x_2) + \Theta(x_1, x_2) \\ \frac{dx_2}{dt} = x_1 + f_{22}(x_1, x_2) + \dots + f_{2h}(x_1, x_2) + \Sigma(x_1, x_2) \end{cases} \tag{2.13}$$

is asymptotically stable (resp.completely unstable)

ii) Property i) not satisfied when h is replaced by any integer $m \in \{2, \dots, h - 1\}$

Proposition 27 [21] *Let h be an integer, $h \geq 3$. The following assertions are equivalent:*

1) *The solution $x_1 = x_2 = 0$ of (2.12) is h -asymptotically stable (resp. h -completely unstable).*

2) *One has $\frac{\partial^i V(0,0)}{\partial c^i} = 0$ for $1 \leq i \leq h - 1$ and $\frac{\partial^h V(0,0)}{\partial c^h} < 0$ (resp. > 0), where V is the displacement function of (2.12), defined in definition 29.*

3) *There exists a Lyapunov function F such that the derivative of F along the solution of (2.12) has the form:*

$$\dot{F}_{(4.6)} = G_h \|x\|^{h+1} + o(\|x\|^{h+1}) \text{ with } G_h < 0 \text{ (resp. } > 0), x = (x_1, x_2).$$

Remark 2 *The Lyapunov function F is searched using the Poincaré procedure in the form*

$F(x) = \sum_{j=1}^h F_j(x)$, where the F_j 's are homogeneous polynomials of degree j in \mathbb{R}^2 .

Theorem 3 [21] *(Generalized Hopf bifurcation theorem)*

Assume that the solution $x_1 = x_2 = 0$ of (2.12) is either 3-asymptotically stable or 3-completely unstable. Then, there exists a real number $\bar{\mu} > 0$ such that for $\mu \in]-\bar{\mu}, \bar{\mu}[$, μ near 0, system (2.7) has exactly one periodic solution if $\alpha(\mu)G_h < 0$ and no periodic solution if $\alpha(\mu)G_h > 0$.

3. The Center Manifold Reduction Of DDE

Let us first very briefly draw the perspective of the center manifold theorem. Consider a general nonlinear DDE

$$\frac{dx}{dt} = f(p, x_t),$$

in which p represents a parameter (possibly, a vector). Assuming that

$$f(p, 0) = 0$$

for all p in a given region, the local behavior of the solutions near 0 is dependent upon the type of the linearized equation

$$\frac{dx}{dt} = D_\varphi f(p, 0)x_t,$$

which can itself be described in terms of the characteristic equation (providing the eigenvalues of the infinitesimal generator of the linear equation)

$$\det(\lambda I - D_\varphi f(p, 0)(\exp(\lambda \cdot) \otimes I)) = 0.$$

In the hyperbolic case, that is to say, as long as the equation has no root with zero real part, solutions which remain close enough to the origin either approach the origin at $+\infty$ or escape from the origin. In particular, no periodic solution can be found in the vicinity of the origin in this situation. This scenario, well known in the case of ODE, has been extended to many infinitely dimensional cases, including DDE. It is a consequence of the so-called saddle-point theorem which can be found, for example, in Hale's books on DDE. We are concerned here with the non hyperbolic case, that is, the situation that arises when for some $p = \pi_c^{\odot*}$, the characteristic equation has a root with zero real part. Amongst the rich variety of cases, we choose one of the two simplest ones: we assume that at p_0 , the characteristic equation has a pair of imaginary roots, each simple, and no other multiple of these numbers (including 0) is a root of the equation.

To be more specific, we will consider the following example, the scalar delay differential equation

$$\frac{dx}{dt} = f(b, \varepsilon, x_t), \quad (3.14)$$

where

$$f(b, \varepsilon, \varphi) = -b\varphi(-1) + \varepsilon(\varphi(-1))^3 + o(\varphi^3),$$

b and ε are two real parameters, $b > 0$, $b \gg |\varepsilon|$. The vector of parameters is $p = (b, \varepsilon)$. Equation (3.14) is an example of equations that has been considered by many authors. An example of such an equation is the logistic delay equation in the case of an odd nonlinearity

$$\frac{dx}{dt} = x(t) \frac{1 - x(t-1)}{1 + x(t-1)}$$

(Change the variable from x to $y = \ln(x)$).

3.1 The linear equation

The linear equation is

$$\frac{dx}{dt} = -bx(t-1), \quad (3.15)$$

There exists a scalar function $\eta(\theta)$ with bounded variation such that

$$-b\varphi(-1) = \int_{-1}^0 [d\eta(\theta)] \varphi(\theta).$$

In fact, $\eta(\theta)$ may be chosen as

$$\eta(\theta) = \begin{cases} 0 & \text{if } \theta = -1 \\ -b & \text{if } -1 < \theta \leq 0. \end{cases}$$

The characteristic equation is obtained by substitution of

$$x(t) = e^{\lambda t} x_0 \quad (x_0 \in C)$$

into the linear equation, that is

$$\lambda + be^{-\lambda} = 0. \quad (3.16)$$

Lemma 25 *If we denote $\sigma(A)$ (resp. $P\sigma(A)$) the spectrum (resp. the point spectrum) of A , $\sigma(A) = P\sigma(A)$ and $\lambda \in \sigma(A)$ if and only if λ satisfies $\lambda + be^{-\lambda} = 0$.*

Lemma 26 *All the roots of equation (3.16) have negative real part if and only if $0 < b < \frac{\pi}{2}$.*

Lemma 27 *The characteristic equation (3.16) has two purely imaginary roots $\lambda_{1,2} = \pm i\frac{\pi}{2}$ and all other roots have negative real parts if $b = \frac{\pi}{2}$.*

The adjoint equation: The formal dual product

$$\langle \psi, \varphi \rangle = \psi(0)\varphi(0) + \int_{-1}^0 \int_{\theta}^0 \psi(s - \theta) d\eta(\theta) \varphi(s) ds$$

leads to

$$\langle \psi, \varphi \rangle = \psi(0)\varphi(0) - b \int_{-1}^0 \psi(s + 1)\varphi(s) ds \quad (3.17)$$

for every pair $\varphi \in \mathbb{E} \stackrel{\text{def}}{=} C([-1, 0]; \mathbb{R})$, $\psi \in \mathbb{E}^* \stackrel{\text{def}}{=} C([0, 1]; \mathbb{R})$.

The adjoint equation is:

$$\frac{dy(s)}{dt} = \int_{-1}^0 y(s - \theta) d\eta(\theta) = by(s + 1) \quad (3.18)$$

If y is a solution of (3.18) on an interval $]-\infty, \sigma + 1[$ then we let y^t for each $t \in (-\infty, \sigma)$ designate the element of \mathbb{E}^* defined by

$$y^t(s) = y(s + t) \text{ for } 0 \leq s \leq 1.$$

We know that if x is a solution of (3.15) on $\tau - 1 < t < +\infty$ and y is a solution of (3.18) on $(-\infty, \sigma + 1)$ with $\sigma > \tau$, then (y^t, x_t) is a constant on $[\tau, \sigma]$.

Let $\Lambda = \left\{ -i\frac{\pi}{2}, +i\frac{\pi}{2} \right\}$. Then $\varphi_1(\theta) = \sin \frac{\pi}{2}\theta$, $\varphi_2(\theta) = \cos \frac{\pi}{2}\theta$ for $-1 \leq \theta < 0$ are two independent solutions of (3.15) in the case $b = \frac{\pi}{2}$. Similarly, $\psi_1^*(s) = \sin \frac{\pi}{2}s$ and $\psi_2^*(s) = \cos \frac{\pi}{2}s$ are two independent solutions of (3.18).

$\Phi = (\varphi_1, \varphi_2)$ is a basis for the generalized eigenspace $P = P_\Lambda$ of (3.15) and $\Psi^* = (\psi_1, \psi_2)$ is a basis for the generalized eigenspace P_Λ^* of (3.18) associated with Λ . The bilinear form $\langle \psi_j, \varphi_k \rangle$, $j, k = 1, 2$ reads

$$\langle \psi_j, \varphi_k \rangle = \psi_j(0)\varphi_k(0) - \frac{\pi}{2} \int_{-1}^0 \psi_j(\theta + 1)\varphi_k(\theta)d\theta; \quad j, k = 1, 2 \quad (3.19)$$

By defining a new basis, still denoted Ψ , for P_Λ^* we can make $(\Psi, \Phi) = I$, I is the identity matrix. We have: $\Psi = col(\psi_1, \psi_2)$ where

$$\begin{cases} \psi_1(s) &= 2\mu_0(\sin \frac{\pi}{2}s + \frac{\pi}{2} \cos \frac{\pi}{2}s), \\ \psi_2(s) &= 2\mu_0(\cos \frac{\pi}{2}s + \frac{\pi}{2} \sin \frac{\pi}{2}s). \end{cases}$$

with $\mu_0 = \frac{1}{1 + \frac{\pi^2}{2}}$. Denote $Q = Q_\Lambda = \{\varphi : \langle \psi_j, \varphi \rangle = 0, j = 1, 2\}$.

We have the decomposition $\mathbb{E} = P \oplus Q$. Hence any $\varphi \in \mathbb{E}$ can be written as $\varphi = \varphi^P + \varphi^Q$ where $\varphi^P = \Phi a_0$, $a_0 = col(a_1, a_2)$, that is,

$$\begin{cases} a_1 = \mu_0\pi\varphi(0) + \mu_0\pi \int_{-1}^0 (\cos \frac{\pi}{2}s - \frac{\pi}{2} \sin \frac{\pi}{2}s)\varphi(s)ds \\ a_2 = 2\mu_0\pi\varphi(0) + \mu_0\pi \int_{-1}^0 (\frac{\pi}{2} \cos \frac{\pi}{2}s + \sin \frac{\pi}{2}s)\varphi(s)ds \end{cases} \quad (3.20)$$

If A is the infinitesimal generator of $T(t)$, then we have $A\Phi = \Phi B$ where

$$B = \begin{bmatrix} 0 & -\frac{\pi}{2} \\ \frac{\pi}{2} & 0 \end{bmatrix}.$$

Therefore $T(t)\Phi = \Phi e^{tB}$. Since $\varphi^Q = \varphi - \varphi^P$, $\varphi^P = \Phi a_0$, $a_0 = (\psi, \varphi)$ it follows that $\|T(t)\varphi - \Phi e^{Bt}a_0\|$ tends to 0 exponentially as t tends to

$+\infty$, for every $\varphi \in \mathbb{E}$. This means that any solution of (3.15) approaches a periodic function given by

$$a_1 \sin \frac{\pi}{2}t + a_2 \cos \frac{\pi}{2}t$$

where a_1 and a_2 are given by (3.20).

3.2 The center manifold theorem

Here, we go through the derivation of the centre manifold made by Diekmann and van Gils. There is part of the method which is general and follows in fact the approach by Vanderbauwhede, and part which is implicated by the delay: essentially, the treatment of the variation of constant formula using the sun-star extension. I will first state the basic problem, taking a general equation:

$$\frac{dx}{dt} = Lx_t + F(x_t) \quad (3.21)$$

We assume that F is smooth, $F(0) = 0$, $DF(0) = 0$. Moreover, I assume that the linear part L has only a stable and a center part, which leads to a decomposition of the state space

$$\mathbb{E} = \mathbb{E}_C \oplus \mathbb{E}_S$$

which corresponds to

$$I = \pi_C + \pi_S.$$

Using the variation of constants formula, equation (3.21) reads as

$$x_t = T(t)\varphi + \int_0^t T^{\odot*}(t-s)F(x_s)ds$$

which decomposes onto the subspaces \mathbb{E}_c and \mathbb{E}_s as follows

$$\pi_C(x_t) = T_C(t)\varphi_C + \int_0^t \pi_C T^{\odot*}(t-s)F(x_s)ds$$

$$\pi_S(x_t) = T_S(t)\varphi_S + \int_0^t \pi_S T^{\odot*}(t-s)F(x_s)ds.$$

Looking for solutions defined on the whole real axis and uniformly bounded on their domain, the second identity can be written starting from any initial point σ

$$\pi_S(x_t) = T_S(t-\sigma)(x_\sigma)_S + \int_\sigma^t \pi_S T^{\odot*}(t-s)F(x_s)ds.$$

Letting $\sigma \rightarrow -\infty$, the term $T_S(t - \sigma)(x_\sigma)_S$ approaches 0, while the integral has a limit, which yields an expression where the projection φ_S has been eliminated

$$\pi_S(x_t) = \int_{-\infty}^t \pi_S T^{\odot*}(t - s) F(x_s) ds.$$

This leads to the following expression for x_t

$$x_t = T_C(t)\varphi_C + \int_0^t \pi_C T^{\odot*}(t - s) F(x_s) ds + \int_{-\infty}^t \pi_S T^{\odot*}(t - s) F(x_s) ds. \tag{3.22}$$

In fact, the above formulas are not correct, the projector π_C is defined on \mathbb{E} , thus it is necessary to extend it to the space \mathbb{E}_C in order to use it in the above expressions. The fact that it can be done in some natural way is proved in the paper by Diekmann and van Gils, who use the following formula, (with the notation $\pi_C^{\odot*}$ used for the extension)

$$\pi_C^{\odot*} = \frac{1}{2\pi i} \int_{\Gamma} (zI - A^{\odot*})^{-1} dz$$

(Γ is a contour enclosing the imaginary roots and no other root)

The following expression is established

$$\pi_C^{\odot*}(\beta, h) = \frac{1}{2\pi i} \int_{\Gamma} e^{z\theta} (zI - L_z)^{-1} \left[\beta + L \left\{ \int_{\eta}^0 e^{z(\eta-s)} h(s) ds \right\} \right] dz, \tag{3.23}$$

with the same meaning for Γ , $L_z = L(e^{z\cdot})$ and $(\beta, h) \in \mathbb{E}^{\odot*} \cong \mathbb{R}^n \times L^\infty([-1, 0], \mathbb{R}^n)$. In terms of $\pi_C^{\odot*}$, (3.22) reads

$$x_t = T_C(t)\varphi_C + \int_0^t \pi_C^{\odot*} T^{\odot*}(t - s) F(x_s) ds + \int_{-\infty}^t (I - \pi_C^{\odot*}) T^{\odot*}(t - s) F(x_s) ds \tag{3.24}$$

Note that $\pi_C^{\odot*}$ is still a projection onto a finite dimensional subspace, in fact, it has the same range as π_C . In order to set up the full equation for the center manifold, there are still two steps: 1) localizing the equation using a truncation; 2) choosing a suitable state space in which the fixed point problem defined by (3.24) makes sense.

Proposition 28 $\pi_C^{\odot*}$ is an extension of π_C to the space and we have

$$\pi_C^{\odot*} \Phi = \langle \psi_1, \Phi \rangle \varphi_1 + \langle \psi_2, \Phi \rangle \varphi_2 \text{ for any } \Phi = (\beta, h) \in \mathbb{E}^{\odot*}$$

ψ_j and φ_j ($j = 1, 2$) are respectively the basis of the space \mathbb{E}_c^* and \mathbb{E}_c .

Proof. We first consider the case when $h = 0$. Then, formula (3.23) reduces to

$$\pi_c^{\odot*}(\beta, 0) = \frac{1}{2\pi i} \int_{\Gamma} \left(e^{z\theta} (zI - L_z)^{-1} \beta \right) dz = \frac{1}{2\pi i} \int_{\Gamma} e^{z\theta} \frac{\Delta(z)}{p(z)} \beta dz,$$

where $\Delta(z)$ is the cofactor matrix of the matrix $zI - L_z$ and $p(z) = \det(zI - L_z)$. Using the residue theorem, we obtain

$$\pi_c^{\odot*}(\beta, 0) = \left(\frac{e^{i\frac{\pi}{2}} \Delta(i\frac{\pi}{2})}{p'(i\frac{\pi}{2})} + \frac{e^{-i\frac{\pi}{2}} \Delta(-i\frac{\pi}{2})}{p'(-i\frac{\pi}{2})} \right) \beta.$$

In the case we are considering here, $\pm i\frac{\pi}{2}$ are of multiplicity 1 and the basis functions φ_j and ψ_j $j = 1, 2$ of \mathbb{E}_c and \mathbb{E}_c^* may be written in the form $\varphi_j = e^{i\theta} v_j$ and $\psi_j = e^{i\theta} w_j$, $j = 1, 2$, with

$$\left(i\frac{\pi}{2}I - L_{i\frac{\pi}{2}} \right) v_j = 0 \text{ and } w_j \left(i\frac{\pi}{2}I - L_{i\frac{\pi}{2}} \right) = 0.$$

Since $i\frac{\pi}{2}$ is of multiplicity 1, we have

$$\mathcal{R} \left(\Delta \left(i\frac{\pi}{2} \right) \right) = \{v_1\}$$

and

$$\mathcal{R} \left(\Delta^{\top} \left(i\frac{\pi}{2} \right) \right) = \{w_1^{\top}\}$$

which implies $w_1 v_1 \neq 0$. $\mathcal{R} \left(\Delta \left(i\frac{\pi}{2} \right) \right)$ and $\mathcal{R} \left(\Delta^{\top} \left(i\frac{\pi}{2} \right) \right)$ denotes the range of the linear operators $\Delta \left(i\frac{\pi}{2} \right)$ and $\Delta^{\top} \left(i\frac{\pi}{2} \right)$, respectively.

Then, we deduce that $\Delta \left(i\frac{\pi}{2} \right) = v_1 w_1$. So,

$$\pi_c^{\odot*}(\beta, 0) = \left(\frac{e^{i\frac{\pi}{2}} v_1 w_1}{p'(i\frac{\pi}{2})} + \frac{e^{-i\frac{\pi}{2}} v_2 w_2}{p'(-i\frac{\pi}{2})} \right) \beta.$$

Hence,

$$\pi_c^{\odot*}(\beta, 0) = (w_1, \beta) \varphi_1 + (w_2, \beta) \varphi_2, \text{ with } w_j = \psi_j(0). \tag{3.24}$$

Let $\varphi \in \mathbb{E} = C([-1, 0], \mathbb{R})$ be such that $\varphi(0) = 0$. Formula (3.23) yields

$$\pi_c^{\odot*}(0, \varphi) = \frac{1}{2\pi i} \int_{\Gamma} \left[e^{z\theta} (zI - L_z)^{-1} L \left\{ e^{z\theta} \int_{\theta}^0 e^{zs} \varphi(s) ds \right\} \right] dz.$$

We may observe that the right hand side of the above formula is equal to $P_0\varphi$, which, on the other hand, can be represented in terms of the formal dual product using formula (3.23). Therefore, we have

$$\pi_c^{\circ*}(0, \varphi) = (\psi_1, \varphi)\varphi_1 + (\psi_2, \varphi)\varphi_2, \text{ such that } \varphi(0) = 0.$$

Since the space $IE^0 = \{\varphi \in \mathbb{E}, \varphi(0) = 0\}$ is dense in $L^1([-1, 0], \mathbb{R})$, the above formula holds for any $(0, \varphi) \in \mathbb{E}^{\circ*}$. Combining the above two results, we deduce that for any $(\beta, h) \in \mathbb{E}^{\circ*}$ we have :

$$\pi_c^{\circ*}(\beta, h) = (\psi_1, (\beta, h))\varphi_1 + (\psi_2, (\beta, h))\varphi_2,$$

where \langle, \rangle is the extension of the formal dual product given by formula (3.17). The proof of Proposition 33 is complete. ■

The spectrum $\sigma(A)$ is a pure point spectrum. \mathbb{E}_c is a two dimensional space on which $T^{\circ*}(t)$ can be extended to a group on \mathbb{R} . Moreover the decomposition is an exponential dichotomy on \mathbb{R} , that is for any $\beta > 0$, there exists a positive constant $k = k(\beta)$ such that

$$\|T(s)x\| \leq k \exp(\beta |s|) \|x\|, \text{ for } s \geq 0 \text{ and } x \in \mathbb{E}_0,$$

$$\|T(s)x^{\circ*}\| \leq k \exp((\gamma + \beta) |s|) \|x^{\circ*}\|, \text{ for } s \geq 0 \text{ and } x^{\circ*} \in \mathbb{E}_s^{\circ*},$$

where

$$\gamma = \sup \{Re\lambda, \lambda \in P\sigma(A^{\circ*}) \text{ and } Re\lambda < 0\}.$$

Observe that we have the same properties for the space $\mathbb{R}^2 \times \mathbb{E}^{\circ*}$, that is $\mathbb{R}^2 \times \mathbb{E}^{\circ*} = (\mathbb{R}^2 \times \mathbb{E}_c) \otimes \mathbb{E}_s^{\circ*}$ and $(\mathbb{R}^2 \times \mathbb{E}_c)$ is a finite dimensional space invariant by $T^{\circ*}(t) \simeq \mathcal{T}(t)$. For a moment, let us consider the general non homogeneous equation associated with (3.35), that is:

$$v(t) = \mathcal{T}(t - s)v(s) + \int_s^t \mathcal{T}^{\circ*}(t - s)h(s)ds. \tag{3.25}$$

The Center manifold theorem. Let us recall a few definitions

Definition 31 [33] $\mathcal{BC}^\nu(\mathbb{R}, \mathbb{E})$ is the space of all continuous function f from \mathbb{R} into \mathbb{E} such that

$$\sup_{\mathbb{R}} (\exp(-\nu t)) \|f(t)\| < \infty.$$

For $\nu = 0$, we write $\mathcal{BC}(\mathbb{R}, E)$. $\mathcal{BC}^\nu(\mathbb{R}, E)$ is a Banach space when endowed with the norm

$$\|f\|_\nu = \sup_{\mathbb{R}} (\exp(-\nu t)) \|f(t)\| < \infty.$$

Definition 32 [33] We define $\mathcal{K} = \mathcal{BC}^\nu(\mathbb{R}, \mathbb{R}^2 \times \mathbb{E}^{\odot*})$ by:

$$(\mathcal{K}h)(t) = \int_0^t \mathcal{T}^{\odot*}(t-s)\pi_c^{\odot*}h(s)ds + \int_0^t \mathcal{T}^{\odot*}(t-s)\pi_s^{\odot*}h(s)ds, \quad (3.26)$$

for $t \in \mathbb{R}$, $\nu \in]0, -\gamma[$. In formula (3.26), $\pi_c^{\odot*}$ and $\pi_s^{\odot*}$ are, respectively, the projections of $(\mathbb{R}^2 \times \mathbb{E}^{\odot*})$ on the subspaces $(\mathbb{R}^2 \times \mathbb{E}_c)$ and $\mathbb{E}_-^{\odot*}$.

Proposition 29 [33] For each $\nu \in]0, -\gamma[$

- 1) \mathcal{K} is a bounded linear mapping from $\mathcal{BC}^\nu(\mathbb{R}, \mathbb{R}^2 \times \mathbb{E}^{\odot*})$ into $\mathcal{BC}^\nu(\mathbb{R}, \mathbb{R}^2 \times \mathbb{E})$. $\mathcal{K}h$ is the unique solution of equation (3.25) in this space with vanishing \mathbb{E}_c^- component at $t = 0$.
- 2) $(I - \pi_c^{\odot*})\mathcal{K}$ is a bounded linear mapping from $\mathcal{BC}^\nu(\mathbb{R}, \mathbb{R}^2 \times \mathbb{E}^{\odot*})$ into $\mathcal{BC}^\nu(\mathbb{R}, \mathbb{R}^2 \times \mathbb{E})$.

Let ξ be a C^∞ -function defined from \mathbb{R}_+ into \mathbb{R} such that

- 1) $\xi(y) = 1$ for $0 \leq y \leq 1$
- 2) $0 \leq \xi(y) \leq 1$ for $1 \leq y \leq 2$
- 3) $\xi(y) = 0$ for $y \geq 2$

For $\delta > 0$, we denote by

$$h_\delta = \mathcal{F}(x)\xi\left(\frac{\|\pi_c^{\odot*}x\|}{\delta}\right)\xi\left(\frac{\|(I - \pi_c^{\odot*})x\|}{\delta}\right).$$

h_δ is a map from $\mathbb{R}^2 \times \mathbb{E}^{\odot*}$ into itself. We still denote by h_δ the map from $\mathcal{BC}^\nu(\mathbb{R}, \mathbb{R}^2 \times \mathbb{E})$ into $\mathcal{BC}^\nu(\mathbb{R}, \mathbb{R}^2 \times \mathbb{E}^{\odot*})$ defined by

$$(h_\delta(f))(t) = h_\delta(f(t)).,$$

For $\nu \in]0, -\gamma[$, we define \mathcal{G} from $\mathcal{BC}^\nu(\mathbb{R}, \mathbb{R}^2 \times \mathbb{E}) \times (\mathbb{R}^2 \times \mathbb{E}_c)$ into $\mathcal{BC}^\nu(\mathbb{R}, \mathbb{R}^2 \times \mathbb{E})$ by

$$\mathcal{G}(u, \varphi) = T(\cdot)\varphi + \mathcal{K}h_\delta(u) \quad (3.27)$$

Theorem 4 [33] Assume that δ is small enough. Then there exists a C^k -mapping u^* defined from $\mathbb{R}^2 \times \mathbb{E}_c$ into $\mathcal{BC}^\nu(\mathbb{R}, \mathbb{R}^2 \times \mathbb{E}_c)$ such that $u = u^*(\varphi)$ is the unique solution in $\mathcal{BC}^\nu(\mathbb{R}, \mathbb{R}^2 \times \mathbb{E})$ of equation $u = \mathcal{G}(u, \varphi)$.

Definition 33 [33] The centre manifold W_c is the image of the map $\mathcal{C} : \mathbb{R}^2 \times \mathbb{E}_0 \longrightarrow \mathbb{R}^2 \times \mathbb{E}$ defined by $\mathcal{C}(\varphi) = u^*(\varphi)(0)$.

In other words, we can define W_c as the graph of the map $\mathcal{C} : \mathbb{R}^2 \times \mathbb{E}_c \longrightarrow \mathbb{E}_s^{\odot*}$ defined by

$$\mathcal{C}(\varphi) = (\pi_s^{\odot*}(u^*(\varphi)))(0).$$

Now let

$$y(t) = (\pi_c^{\odot*}(u^*(\varphi)))(0)(t).$$

Then y satisfies the equation:

$$y(t) = \mathcal{T}(t)y(0) + \int_0^t \mathcal{T}^{\odot*}(t-s)\pi_c^{\odot*}h_\delta(\mathcal{C}(y(s)))ds. \quad (3.28)$$

Differentiating (3.28), we obtain

$$\frac{dy}{dt} = Ay(t) + \pi_c^{\odot*}h_\delta(\mathcal{C}(y(t))), \quad y(t) \in \mathbb{R}^2 \times \mathbb{E}_c. \quad (3.29)$$

We write

$$y(t) = (b, \varepsilon, z(t)) \in \mathbb{R}^2 \times \mathbb{E}_c$$

where $z(t) \in \mathbb{E}_c$. Therefore

$$\mathcal{C}(y(t)) \in \mathbb{R}^2 \times \mathbb{E}_c \oplus \mathbb{E}_s^{\odot*}$$

Then we can write:

$$\mathcal{C}(y(t)) = (b, \varepsilon, z(t), \mathcal{M}(b, \varepsilon, z(t))) \text{ where } \mathcal{M}(b, \varepsilon, z(t)) \in \mathbb{R}^2 \times \mathbb{E}_s^{\odot*}.$$

3.3 Back to the nonlinear equation:

Now, consider the nonlinear delay equation:

$$\frac{dx(t)}{dt} = -bx(t-1) + \varepsilon x^3(t-1) + o\left((x_t)^3\right). \quad (3.30)$$

(3.30) may be written in the form:

$$\frac{dx(t)}{dt} = \int_{-1}^0 d\eta(s)x(t-s) + g(\varepsilon, x_t), \quad (3.31)$$

$g(\varepsilon, \varphi) = \varepsilon\varphi^3(-1) + o\left((\varphi)^3\right)$ with the initial condition: $x(\theta) = \varphi(\theta)$ for $-1 \leq \theta \leq 0$; $\varphi \in X = \mathbb{E}$.

Returning to the nonlinear delay equation (3.30), we supplement it with two trivial equations $\frac{db}{dt} = 0$ and $\frac{d\varepsilon}{dt} = 0$. Precisely, we are concerned in the sequel with the system of delay equations

$$\left\{ \begin{array}{l} \frac{dx}{dt} = Lx_t + N(b, \varepsilon, x_t), \\ \frac{db}{dt} = 0, \\ \frac{d\varepsilon}{dt} = 0, \end{array} \right. \quad (3.32)$$

with

$$N(b, \varepsilon, x_t) = -(b - \frac{\pi}{2})x(t - 1) + g(\varepsilon, x_t)$$

and

$$Lx_t = -\frac{\pi}{2}x(t - 1).$$

Equation (3.32) may be interpreted as an evolution equation of the form:

$$\begin{cases} \frac{d}{dt}(x_t) &= Ax_t + r^{\odot*}N(b, \varepsilon, x_t), \\ \frac{db}{dt} &= 0, \\ \frac{d\varepsilon}{dt} &= 0, \end{cases} \tag{3.33}$$

where A is the infinitesimal generator of the semi-group $\{T(t)\}$, solution of the linear equation $\frac{dx}{dt} = Lx_t$ and $r^{\odot*} = (I, 0)$.

We note that the map

$$\varphi \longrightarrow r^{\odot*}N(b, \varepsilon, x_t)$$

is defined from \mathbb{E} into $\mathbb{E}^{\odot*}$. If we identify $\varphi \in \mathbb{E}$ with $(\varphi(0), \varphi) \in \mathbb{E}^{\odot\odot}$ then equation (3.33) may be written in the form:

$$\begin{cases} \frac{du}{dt} &= (A_0^{\odot*} + r^{\odot*}L)u + F(b, \varepsilon, x_t), \\ \frac{db}{dt} &= 0, \\ \frac{d\varepsilon}{dt} &= 0. \end{cases} \tag{3.34}$$

F is a continuous function defined from $\mathbb{R}^3 \times \mathbb{E}$ into $\mathbb{E}^{\odot*}$ and $u = x_t$. The variation of constant formula in this case is

$$v(t) = T(t - s)v(s) + \int_s^t T^{\odot*}(t - s)\mathcal{F}(v(s))ds \tag{3.35}$$

with

$$v(t) = (b, \varepsilon, u(t)), \mathcal{F}(v(t)) = (F(b, \varepsilon, u(t)), 0, 0)$$

and

$$T(b, \varepsilon, u(t)) = (b, \varepsilon, T(t)\varphi).$$

Hence, the ordinary equation (3.29) becomes, in our case,

$$\begin{cases} \frac{dz(t)}{dt} &= Bz(t) + \beta(\Phi z(t) + \mathcal{M}(b, \varepsilon, z(t))(-1)) + \varepsilon(\Phi z(t) + \mathcal{M}(b, \varepsilon, z(t))(-1))^3 + \\ & o(\Phi z(t) + \mathcal{M}(b, \varepsilon, z(t))(-1))^3 \psi(0) \\ \frac{d\beta}{dt} &= 0 \\ \frac{d\varepsilon}{dt} &= 0 \end{cases} \tag{3.36}$$

with

$$\psi(0) = \begin{pmatrix} \mu_0\pi \\ 2\mu_0 \end{pmatrix}, \mu_2 = \frac{1}{1 + \frac{\pi^2}{2}}, \Phi = \begin{pmatrix} -1 \\ 0 \end{pmatrix} \text{ and } \beta = b - \frac{\pi}{2}.$$

So we obtain:

$$\begin{cases} \frac{d}{dt} z_1(t) &= -\frac{\pi}{2} z_2(t) + \mathcal{M}(b, \varepsilon, z(t))(-1) + \varepsilon\mu_0\pi(-z_1(t) + \mathcal{M}(b, \varepsilon, z(t)))^3 + \\ & o(-z_1(t) + \mathcal{M}(b, \varepsilon, z(t)))^3 \\ \frac{d}{dt} z_2(t) &= (\frac{\pi}{2} + \mu_0\pi\beta)z_1(t) - 2\beta\mu_0\mathcal{M}(b, \varepsilon, z(t))(-1) + \\ & 2\mu_0\varepsilon(-z(t) + \mathcal{M}(b, \varepsilon, z(t))(-1))^3 + o(-z_1(t) + \mathcal{M}(b, \varepsilon, z(t)))^3 \\ \frac{d\beta}{dt} &= 0 \\ \frac{d\varepsilon}{dt} &= 0 \end{cases} \tag{3.37}$$

Note that $\mathcal{M}(b, \varepsilon, 0) = 0$, $\frac{d}{dt}\mathcal{M}(b, \varepsilon, 0)z = z$ and $z \rightarrow \mathcal{M}(b, \varepsilon, z)$ is C^k with $k \geq 2$, since g is a C^∞ function with respect to φ , satisfying $g(\varepsilon, 0) = 0$, $Dg(\varepsilon, 0) = 0$. From now on, we will be concerned with the ordinary differential equation in \mathbb{R}^2 parametrized by β and ε (β and ε are in the neighborhood of 0). The next section will be devoted to the existence of periodic solutions of the equation

$$\begin{cases} \frac{d}{dt} z_1(t) &= -\frac{\pi}{2} z_2(t) + \mathcal{M}(b, \varepsilon, z(t))(-1) + \varepsilon\mu_0\pi(-z_1(t) + \mathcal{M}(b, \varepsilon, z(t)))^3 \\ & + o(-z_1(t) + \mathcal{M}(b, \varepsilon, z(t)))^3 \\ \frac{d}{dt} z_2(t) &= (\frac{\pi}{2} + \mu_0\pi\beta)z_1(t) - 2\beta\mu_0\mathcal{M}(b, \varepsilon, z(t))(-1) + \\ & 2\mu_0\varepsilon(-z(t) + \mathcal{M}(b, \varepsilon, z(t))(-1))^3 + o(-z_1(t) + \mathcal{M}(b, \varepsilon, z(t)))^3 \end{cases} \tag{3.38}$$

3.4 The reduced system

We are now in a position to discuss the behavior of the reduced ordinary differential system.

We first concentrate on the case $\beta = 0$ (β is defined in section 3, $\beta = 0$ corresponds to $b = \frac{\pi}{2}$). In this case, our ODE is reduced to

$$\begin{aligned} \frac{d}{dt} z_1(t) &= -\frac{\pi}{2} z_2(t) + \varepsilon\mu_0\pi[-z_1(t) + \mathcal{M}(\varepsilon, z(t))(-1)]^3 + o[-z_1(t) + \mathcal{M}(\varepsilon, z(t))(-1)]^3 \\ \frac{d}{dt} z_2(t) &= \frac{\pi}{2} z_1(t) + 2\varepsilon\mu_0[-z_1(t) + \mathcal{M}(\varepsilon, z(t))(-1)]^3 + o[-z_1(t) + \mathcal{M}(\varepsilon, z(t))(-1)]^3 \end{aligned} \tag{3.39}$$

where $\mathcal{M}(\varepsilon, z(t))(-1) = \mathcal{M}(0, \varepsilon, z(t))(-1)$.

Since $\mathcal{M}(\beta, \varepsilon, 0) = 0$ and $\frac{\partial \mathcal{M}(\beta, \varepsilon, 0)}{\partial z} z = z$, $\mathcal{M}(\beta, \varepsilon, z(t))(-1)$ is a $o(\|z\|)$ that is $\frac{\mathcal{M}(\beta, \varepsilon, z)}{\|z\|} \rightarrow 0$ as $z \rightarrow 0$.

A natural candidate to be the principal part of system (3.39) is the system

$$\begin{cases} \frac{d}{dt} z_1(t) = -\frac{\pi}{2} z_2(t) - \varepsilon \mu_0 \pi [z_1(t)]^3 \\ \frac{d}{dt} z_2(t) = \frac{\pi}{2} z_1(t) - 2\varepsilon \mu_0 [-z_1(t)]^3 \end{cases} \quad (3.40)$$

Proposition 30 *The origin $z = 0$ of (3.40) is 3-asymptotically stable if $\varepsilon > 0$ (3-completely-unstable if $\varepsilon < 0$).*

Before we proceed to the proof of proposition 4.2, let us derive its consequences on equation (3.14).

Corollary 5 *The origin of equation (3.14).is asymptotically stable if $\varepsilon > 0$ and unstable if $\varepsilon < 0$.*

Proof of Corollary 5

Equation (3.39) is a perturbation of order $o(\|z\|^3)$ of equation (3.40). Therefore, it enjoys the same stability properties as equation (3.40), when the latter is either 3-asymptotically stable or 3-completely unstable. Since equation (3.39) is the reduced equation of equation (3.14) on the centre manifold we deduce from the fundamental centre manifold theorem that the two equations have the same stability properties, that is the origin of (3.14).is asymptotically stable if $\varepsilon > 0$ and unstable if $\varepsilon < 0$.

Proof of Proposition 4.2

Proving that the origin of (3.40) is 3-asymptotically stable (resp. 3-completely-unstable) is equivalent to determining a Lyapunov function F of the form

$$F(z_1, z_2) = z_1^2 + z_2^2 + F_3(z_1, z_2) + F_4(z_1, z_2)$$

such that

$$\dot{F}(z_1, z_2) = G_h(z_1^2 + z_2^2)^2 + o(\|(z_1, z_2)\|^4) \quad (3.41)$$

with $G_h < 0$ (resp. $G_h > 0$), (F_3 and F_4 are two homogeneous polynomials of degree 3 and 4 respectively).

We have

$$\dot{F}(z_1, z_2) = \left(-\frac{\pi}{2} z_2\right) \frac{\partial F}{\partial z_1} + \left(\frac{\pi}{2} z_2\right) \frac{\partial F}{\partial z_2} - (\varepsilon \mu_0 \pi z_1^3) \frac{\partial F}{\partial z_1} - (2\varepsilon \mu_0 z_1^3) \frac{\partial F}{\partial z_2},$$

that is

$$\begin{aligned} \dot{F}(z_1, z_2) = & \left(-\frac{\pi}{2} z_2\right) \frac{\partial F_3}{\partial z_1} + \left(\frac{\pi}{2} z_2\right) \frac{\partial F_3}{\partial z_2} - (\varepsilon \mu_0 \pi z_1^3) \frac{\partial F_3}{\partial z_1} - (2\varepsilon \mu_0 z_1^3) \frac{\partial F_4}{\partial z_2} + \left(-\frac{\pi}{2} z_2\right) \frac{\partial F_4}{\partial z_1} \\ & + \left(\frac{\pi}{2} z_2\right) \frac{\partial F_4}{\partial z_2} - (\varepsilon \mu_0 \pi z_1^3) \frac{\partial F_4}{\partial z_1} - (2\varepsilon \mu_0 z_1^3) \frac{\partial F_4}{\partial z_2} - 2\varepsilon \mu_0 \pi z_1^4 - 4\varepsilon \mu_0 z_1^3 z_2. \end{aligned}$$

Let T denote the operator $-z \frac{\partial}{\partial z_1} + z_1 \frac{\partial}{\partial z_2}$ and T_j its restriction to the space P_j of homogeneous polynomials of degree j . We know from [14] that T_j is a bijection from P_j to P_j when j is odd. Then, equating terms with the same degree on both sides of (3.41), we arrive at

$$\frac{\pi}{2} T_3 F_3 = 0, \text{ that is } F_3 = 0,$$

$$\frac{\pi}{2} T_4 F_4 = G_4 (z_1^2 + z_2^2)^2 + 2\mu_0 \varepsilon \pi z_1^4 + 4\mu_0 \varepsilon z_1^3 z_2 \tag{3.42}$$

and

$$-(\varepsilon \mu_0 z_1^3) \frac{\partial F_4}{\partial z_1} - (2\varepsilon \mu_0 z_1^3) \frac{\partial F_4}{\partial z_2} = o\left((z_1^2 + z_2^2)^2\right).$$

F_4 is a homogeneous polynomial of degree 4,

$$F_4 = a_1 z_1^4 + a_2 z_1^3 z_2 + a_3 z_1^2 z_2^2 + a_4 z_1 z_2^3 + a_5 z_2^4, (a_i \in \mathbb{R}, \text{ for } 1 \leq i \leq 5).$$

Formula (3.42) yields a system of linear equations,

$$\begin{aligned} a_2 &= \frac{2}{\pi} G_4 + 4\varepsilon \mu_0 \\ a_3 - 2a_1 &= \frac{4}{\pi} \mu_0 \varepsilon \\ a_4 - a_2 &= \frac{4}{3\pi} G_4 \\ 2a_5 - a_3 &= 0 \\ -a_4 &= \frac{2}{\pi} G_4 \end{aligned}$$

from which we deduce

$$G_4(\varepsilon) = -\frac{3}{4} \mu_0 \varepsilon \pi, \tag{3.43}$$

$$a_4 = \frac{3}{2} \mu_0 \varepsilon, a_2 = \frac{5}{2} \mu_0 \varepsilon, a_5 = \frac{1}{2} a_3, a_1 = \frac{1}{2} a_3 - \frac{2}{\pi} \mu_0 \varepsilon; a_3 \in \mathbb{R}.$$

We know from [14] that the homogenous polynomials of even degree j are determined up to the addition of constant terms $(z_1^2 + z_2^2)^j$. Therefore, we can choose $a_3 = 0$ and the Lyapunov function F is

$$F(z_1, z_2) = z_1^2 + z_2^2 - \frac{2}{\pi} \mu_0 \varepsilon z_1^4 + \frac{5}{2} \mu_0 \varepsilon z_1^3 z_2 + \frac{3}{2} \mu_0 \varepsilon z_1 z_2^3.$$

We observe that $G_4(\varepsilon) < 0$ if $\varepsilon > 0$ and $G_4(\varepsilon) > 0$ if $\varepsilon < 0$. This means that system (3.40) is 3-asymptotically stable if $\varepsilon > 0$ and 3-completely unstable if $\varepsilon < 0$. ■

Proposition 31 *Suppose $f(b, \varepsilon, \varphi) = -b\varphi(-1) + \varepsilon(\varphi(-1))^3 + a(\varphi(-1))^5$. For $\varepsilon = 0, \beta = 0$ and $a \neq 0$, the origin $x = 0$ is 5-asymptotically stable (respectively, 3-completely unstable) if $a > 0$ (resp. $a < 0$).*

Proof. The reduced ordinary differential system associated to (3.14) becomes

$$\begin{cases} \frac{d}{dt} z_1(t) = -\frac{\pi}{2} z_2(t) + \varepsilon \mu_0 \pi [-z_1(t) + \mathcal{M}(\beta, \varepsilon, z(t))(-1)]^3 \\ \quad + a \mu_0 \pi [-z_1(t) + \mathcal{M}(\beta, \varepsilon, z(t))(-1)]^5 \\ \frac{d}{dt} z_2(t) = \frac{\pi}{2} z_1(t) + 2\varepsilon \mu_0 [-z_1(t) + \mathcal{M}(\beta, \varepsilon, z(t))(-1)]^3 \\ \quad + 2a \mu_0 [-z_1(t) + \mathcal{M}(\beta, \varepsilon, z(t))(-1)]^5 \end{cases} \quad (3.44)$$

The candidate to be the principal part of (3.44) is the system:

$$\begin{cases} \frac{d}{dt} z_1(t) = -\frac{\pi}{2} z_2(t) - a \mu_0 \pi z_1^5(t) \\ \frac{d}{dt} z_2(t) = \frac{\pi}{2} z_1(t) - 2a \mu_0 z_1^5(t) \end{cases} \quad (3.45)$$

Using once again the Poincaré procedure, we show that the function given by

$$F(z_1, z_2) = z_1^2 + z_2^2 - \frac{4}{3\pi} a \mu_0 z_1^6 - \frac{11}{4} a \mu_0 z_1^5 z_2 + \frac{10}{3} \mu_0 a z_1^3 z_2^3 + \frac{5}{4} a \mu_0 \pi z_1 z_2^5$$

is a Lyapounov function of system (3.45). Its derivative along the solutions of (3.45) is

$$\dot{F}(z_1, z_2) = -\frac{5}{4} a \mu_0 \pi (z_1^2 + z_2^2)^3 + o\left((z_1^2 + z_2^2)^3\right).$$

Thus, near the origin, \dot{F} has the sign of $-a$, which gives the conclusion of the proposition

Remark 4.2

System (3.39) is a perturbation of system (3.40). From Proposition 30 and generalized Hopf bifurcation theorem, Theorem 3, we can only conclude that system (3.39) has no more than one periodic solution. Because the linear part of this system is independent of the parameter ε , the condition given in terms of the sign of $\alpha(\mu) G_h$ (see Theorem 3) is not fulfilled.

4. Cases Where The Approximation Of Center Manifold Is Needed

Let f be a real function defined on \mathbb{R} . Reconsider the delay equation

$$x'(t) = f(x(t-1)). \quad (4.46)$$

Assume that f satisfies the following assumptions

$$(H) : \begin{cases} f \in C^k(\mathbb{R}) & \text{for some } k \geq 3 \\ f(0) = 0. \end{cases}$$

Equation (4.46) may be written as

$$x'(t) = -\gamma x(t-1) + \alpha x^2(t-1) + \varepsilon x^3(t-1) + o(x^3(t-1)), \quad (4.47)$$

where $\gamma = -f'(0)$, $\alpha = \frac{1}{2}f''(0)$ and $\varepsilon = \frac{1}{3!}f'''(0)$.

In the last section, $f''(0) = 0$.

If we use the method developed before. The presence of a quadratic term in equation (4.47) creates an additional difficulty compared to the situation dealt with in the last section, also in several other works where it is assumed that the nonlinearity is odd. The determination of the Lyapunov function leads us to give an explicit approximation of the homogeneous part of degree two of the local center manifold near zero associated to equation (4.47) for the value $\gamma = \frac{\pi}{2}$.

It is also possible to extend the procedure to compute a center manifold for a general autonomous functional differential equation.

4.1 Approximation of a local center manifold

Let us now briefly describe what the local center manifold theorem tells us. For the most recent and satisfactory presentation of this result, we refer to Diekmann and van Gils [33]. So, equation (4.47) has a local center manifold

$$\begin{aligned} M : U \times V &\longrightarrow X_s \\ (\beta, \xi) &\longmapsto M(\beta, \xi), \end{aligned}$$

where U (resp. V) is a neighborhood of zero in \mathbb{R} (resp. \mathbb{R}^2).

On this center manifold the delay equation (4.47) is reduced to an ordinary differential one, given by

$$\left\{ \begin{aligned} \frac{dz(t)}{dt} &= Bz(t) + \Psi(0) [-\beta(\Phi(-1)z(t) + M(\beta, z(t))(-1)) \\ &\quad + \alpha(\Phi(-1)z(t) + M(\beta, z(t))(-1))^2 \\ &\quad + \varepsilon(\Phi(-1)z(t) + M(\beta, z(t))(-1))^3 \\ &\quad + o((\Phi(-1)z(t) + M(\beta, z(t))(-1))^3)] \\ \frac{d\beta(t)}{dt} &= 0, \end{aligned} \right. \quad (4.48)$$

where

$$B = \begin{bmatrix} 0 & -\frac{\pi}{2} \\ \frac{\pi}{2} & 0 \end{bmatrix}.$$

Denote by

$$h(\xi) = M(0, \xi), \text{ for each } \xi \in V.$$

h is a function with values in X_s . Under the regularity assumption made on f , we know that one can assume that the center manifold to be C^k . We also know that the center manifold is tangent to X_c , which implies that $Dh(0) = 0$, and of course $h(0) = 0$. The Taylor expansion of h near $\xi = 0$ yields

$$h(\xi) = a\xi_1^2 + b\xi_1\xi_2 + c\xi_2^2 + o(|\xi|^2)$$

in which a, b, c are elements of X_s . We denote by

$$h_2(\xi) = a\xi_1^2 + b\xi_1\xi_2 + c\xi_2^2, \quad (4.49)$$

the homogeneous part of degree two of h . Even though center manifolds are not unique, we know however that the Taylor expansion at any order is unique. The following lemma provides us with an effective way to determine the coefficients a, b and c .

Theorem 6 *Let $a, b, c \in X_s$, be the coefficients of h_2 . Then (a, b, c) is a solution of the following system of equations:*

$$\begin{cases} a'(\theta) = \frac{\pi}{2}b(\theta) + \Phi(\theta)\Psi(0)\alpha \\ b'(\theta) = -\pi a(\theta) + \pi c(\theta) \\ c'(\theta) = -\frac{\pi}{2}b(\theta) \end{cases} \quad (4.50)$$

for $\theta \in [-1, 0]$ and

$$\begin{cases} a'(0) + \frac{\pi}{2}a(-1) = \alpha \\ b'(0) + \frac{\pi}{2}b(-1) = 0 \\ c'(0) + \frac{\pi}{2}c(-1) = 0, \end{cases} \quad (4.51)$$

where Φ and Ψ are as in section 2 and α is the coefficient of $(x(t-1))^2$ in equation (4.47).

Proof : For every $\xi \in V$, denote by $z(t)$ the solution of the ordinary differential equation

$$\begin{cases} \frac{dz(t)}{dt} &= Bz(t) + \Psi(0)g(\Phi(-1)z(t) + h(z(t))(-1)) \\ z(0) &= \xi, \end{cases} \tag{4.52}$$

where $g(x) = \frac{\pi}{2}x + f(x) = \frac{\pi}{2}x + (-\gamma x + \alpha x^2 + \varepsilon x^3 + o(x^3))$.

The first property of a center manifold is that it is invariant with respect to the original semiflow. So, if z is a solution of equation (3.19), then, the function $t \mapsto \Phi z(t) + h(z(t))$ is a solution of equation (4.47). This, in particular, implies that it verifies the translation property, for each $t \in [0, 1]$ and $\theta \in [-1, -t]$ (ie : $t + \theta \leq 0$),

$$\Phi(\theta)z(t) + h(z(t))(\theta) = \Phi(t + \theta)\xi + h(\xi)(t + \theta). \tag{4.53}$$

By differentiating equation (4.53) with respect to t and rearranging terms,

$$\begin{aligned} \frac{\partial h(\xi)}{\partial \theta}(t + \theta) + \Phi(t + \theta)B\xi &= \left[\Phi(\theta) + \frac{\partial h}{\partial z}(z(t))(\theta) \right] \\ &\times [Bz(t) + \Psi(0)g(\Phi(-1)z(t) + h(z(t))(-1))]. \end{aligned} \tag{4.54}$$

So, letting t go to 0, from above , it follows that

$$\begin{aligned} \frac{\partial h(\xi)}{\partial \theta}(\theta) &= \frac{\partial h}{\partial z}(\xi)(\theta) [B\xi + \Psi(0)g(\Phi(-1)\xi + h(\xi)(-1))] \\ &+ \Phi(\theta)\Psi(0)g(\Phi(-1)\xi + h(\xi)(-1)). \end{aligned} \tag{4.55}$$

On the other hand, the local semi flow $t \mapsto \Phi z(t) + h(z(t))$ generated by the delay equation (4.47) with $\gamma = \frac{\pi}{2}$ on the center manifold is differentiable at $t = 0$. So,

$$\frac{\partial}{\partial \theta} [\Phi\xi + h(\xi)](0) = -\frac{\pi}{2} [\Phi(-1)\xi + h(\xi)(-1)] + g(\Phi(-1)\xi + h(\xi)(-1)),$$

which implies

$$\frac{\partial h(\xi)}{\partial \theta}(0) = -\frac{\pi}{2}h(\xi)(-1) + g(\Phi(-1)\xi + h(\xi)(-1)). \tag{4.56}$$

The homogeneous part of degree two with respect to ξ of (4.55) and (4.56) respectively, is given by

$$\frac{\partial h_2(\xi)}{\partial \theta}(\theta) = \frac{\partial h_2}{\partial z}(\xi)(\theta) [B\xi] + \Phi(\theta)\Psi(0)g_2(\Phi(-1)\xi) \tag{4.57}$$

and

$$\frac{\partial h_2(\xi)}{\partial \theta}(0) = -\frac{\pi}{2}h_2(\xi)(-1) + g_2(\Phi(-1)\xi). \tag{4.58}$$

Then, if we note that $g_2(x) = \alpha x^2$, conditions (4.50) and (4.51) follow respectively from (4.57) and (4.58). ■

Remark We already know that (a, b, c) are unique as coefficients of the quadratic part of the Taylor expansion of h . However, it is not obvious from the beginning that the system of equations (4.50) and (4.51) they satisfy determines these coefficients in a unique way. The following proposition provides us with uniqueness of the solution of that system of equations.

Proposition 32 *The solution of the ordinary differential equation (4.50) with the boundary conditions (4.51) is unique.*

Proof : Put

$$H = \begin{bmatrix} 0 & \frac{\pi}{2} & 0 \\ -\pi & 0 & \pi \\ 0 & \frac{\pi}{2} & 0 \end{bmatrix} \text{ and } X = \begin{bmatrix} a \\ b \\ c \end{bmatrix}.$$

By the use of the variation of constant formula, the general solution of (4.50) is given by

$$X(\theta) = \exp(H\theta) X(0) + S(\theta),$$

where

$$S(\theta) = \int_0^\theta \exp(H(\theta - s)) \text{col}(\Phi(s)\Psi(0)\alpha, 0, 0) ds.$$

The boundary condition (4.51) reads

$$\left[H + \frac{\pi}{2} \exp(-H) \right] X(0) + \text{col}(\Phi(s)\Psi(0)\alpha, 0, 0) + \frac{\pi}{2} S(-1) = \text{col}(\alpha, 0, 0). \tag{4.59}$$

Hence, if we notice that

$$\exp(H\theta) = \begin{bmatrix} \frac{1}{2}[1 + \cos(\pi\theta)] & \frac{1}{2}\sin(\pi\theta) & \frac{1}{2}[1 - \cos(\pi\theta)] \\ -\sin(\pi\theta) & \cos(\pi\theta) & \sin(\pi\theta) \\ \frac{1}{2}[1 - \cos(\pi\theta)] & -\frac{1}{2}\sin(\pi\theta) & \frac{1}{2}[1 + \cos(\pi\theta)] \end{bmatrix}, \tag{4.60}$$

then, by virtue of (4.59), it follows that $X(0)$ is a solution of the linear system

$$DX(0) = e, \tag{4.61}$$

where

$$D = \begin{bmatrix} 0 & 1 & 1 \\ -2 & -1 & 2 \\ 1 & -1 & 0 \end{bmatrix}$$

and

$$e = -S(-1) + \text{col} \left(\frac{2\alpha}{\pi} (1 - 2\mu_0), 0, 0 \right).$$

Since the matrix D is invertible, hence, existence and uniqueness of $X(0)$ are ensured from (4.61). Therefore, existence and uniqueness of the solution of (4.50) and (4.51) hold. ■

Corollary 7 *Let $a, b, c \in \mathcal{C}$. (a, b, c) are the coefficients of the quadratic part of the Taylor expansion of h if and only if (a, b, c) is the solution of the system of equations (4.50) and (4.51).*

Corollary 8 *If $a, b, c \in X_s$ are the coefficients of h_2 , then*

$$\begin{cases} a(-1) = \frac{6\alpha}{5\pi} - \frac{4\alpha\mu_0}{3\pi} \\ b(-1) = -\frac{4\alpha}{5\pi} + \frac{4\alpha\mu_0}{3} \\ c(-1) = \frac{4\alpha}{5\pi} - \frac{8\alpha\mu_0}{3\pi}. \end{cases}$$

Proof : By virtue of the expression (4.60) of $\exp(A\theta)$, it follows that

$$S(-1) = \text{col} \left(\frac{4\mu_0\alpha}{3} - \frac{4\mu_0\alpha}{3\pi}, \frac{4\mu_0\alpha}{3} - \frac{8\mu_0\alpha}{3\pi}, \frac{2\mu_0\alpha}{3} - \frac{8\mu_0\alpha}{3\pi} \right)$$

Moreover, the inverse matrix of D is given by

$$D^{-1} = \frac{1}{5} \begin{bmatrix} 2 & -1 & 3 \\ 2 & -1 & -2 \\ 3 & 1 & 2 \end{bmatrix}.$$

Hence, from (4.61) it follows that

$$X(0) = \text{col} \left(\frac{4\alpha}{5\pi} - \frac{2\alpha\mu_0}{3}, \frac{4\alpha}{5\pi} - \frac{8\alpha\mu_0}{3\pi}, \frac{6\alpha}{5\pi} - \frac{4\alpha\mu_0}{3} \right).$$

So, by substituting the expressions of $a(0)$, $b(0)$ and $c(0)$ in the equation (4.51), the result follows immediately. ■

4.2 The reduced system

We are now in position to study the reduced system (4.48). First, suppose that $\beta = 0$ (i.e. $\gamma = \frac{\pi}{2}$). Then, equation (4.48) becomes

$$\left\{ \begin{array}{l} \frac{dz_1}{dt} = -\frac{\pi}{2}z_2 + \mu_0\alpha\pi(-z_1 + h(z)(-1))^2 \\ \quad + \mu_0\varepsilon\pi(-z_1 + h(z)(-1))^3 \\ \quad + o\left[(-z_1 + h(z)(-1))^3\right] \\ \frac{dz_2}{dt} = \frac{\pi}{2}z_1 + 2\mu_0\alpha(-z_1 + h(z)(-1))^2 \\ \quad + 2\mu_0\varepsilon(-z_1 + h(z)(-1))^3 \\ \quad + o\left[(-z_1 + h(z)(-1))^3\right]. \end{array} \right. \quad (4.62)$$

In the sequel, we mainly deal with 3-asymptotic stability and 3-complete unstability of the trivial solution $z \equiv 0$ of (4.62). To this end, it is enough to consider the system

$$\left\{ \begin{array}{l} \frac{dz_1}{dt} = -\frac{\pi}{2}z_2 + \mu_0\alpha\pi(-z_1 + h(z)(-1))^2 - \pi\mu_0\varepsilon z_1^3 \\ \frac{dz_2}{dt} = \frac{\pi}{2}z_1 + 2\mu_0\alpha(-z_1 + h(z)(-1))^2 - 2\mu_0\varepsilon z_1^3. \end{array} \right. \quad (4.63)$$

Proposition 33 *Under the standing hypothesis (H), it follows that*

i) If $\varepsilon > 0$ and $\alpha \in \mathbb{R}$, then the trivial solution $z \equiv 0$ of (4.63) is 3-asymptotically stable.

ii) If $\varepsilon < 0$, then there is $\alpha_0(\varepsilon) \in \mathbb{R}^+$ such that the trivial solution $z \equiv 0$ of (4.63) is 3-asymptotically stable for $\alpha \in]-\infty, -\alpha_0(\varepsilon)[\cup]\alpha_0(\varepsilon), \infty[$ and 3-completely unstable for $\alpha \in]-\alpha_0(\varepsilon), \alpha_0(\varepsilon)[$.

Proof: Coming back to proposition (27)[21] it suffices to prove the existence of a map F satisfying

$$F'_{(4.63)}(z_1, z_2) = G_3(z_1^2 + z_2^2)^2 + o\left[(z_1^2 + z_2^2)^2\right], \quad (4.64)$$

with $G_3 \in \mathbb{R} \setminus \{0\}$. In [14], the authors have proved that such a map may be computed using the Poincaré procedure,

$$F(z) = \sum_{j=1}^4 F_j(z), \tag{4.65}$$

where F_j is a homogeneous polynomial of degree j . Let F be a functional having the form (4.65). Then

$$\begin{aligned} F'_{(4.63)}(z_1, z_2) &= \frac{\pi}{2}T_2F_2 + \frac{\pi}{2}T_3F_3 + \frac{\pi}{2}T_4F_4 \\ &+ \left(\frac{\partial F_2}{\partial z_1} + \frac{\partial F_3}{\partial z_1} + \frac{\partial F_4}{\partial z_1}\right) \left(\mu_0\alpha\pi(-z_1 + h(z)(-1))^2 - \pi\mu_0\varepsilon z_1^3\right) \\ &+ \left(\frac{\partial F_2}{\partial z_2} + \frac{\partial F_3}{\partial z_2} + \frac{\partial F_4}{\partial z_2}\right) \left(2\mu_0\alpha(-z_1 + h(z)(-1))^2 - 2\mu_0\varepsilon z_1^3\right), \end{aligned}$$

where T_j is a linear operator defined on the space of homogeneous polynomials of degree j by

$$T_jP = -z_2\frac{\partial P}{\partial z_1} + z_1\frac{\partial P}{\partial z_2}.$$

The expression of $F'_{(4.63)}(z_1, z_2)$ is desired to be of the form (4.64), which is equivalent to the three relations :

- (i) $T_2F_2 = 0$.
- (ii) $\frac{\pi}{2}T_3F_3 + \left(\pi\frac{\partial F_2}{\partial z_1} + 2\frac{\partial F_2}{\partial z_2}\right) (\mu_0\alpha z_1^2) = 0$.
- (iii)

$$\begin{aligned} G_3z_1^4 + 2G_3z_1^2z_2^2 + G_3z_2^4 &= \frac{\pi}{2}T_4F_4 + \left(\pi\frac{\partial F_3}{\partial z_1} + 2\frac{\partial F_3}{\partial z_2}\right) (\mu_0\alpha z_1^2) \\ &+ \left(\pi\frac{\partial F_2}{\partial z_1} + 2\frac{\partial F_2}{\partial z_2}\right) (-2\mu_0\alpha P(z)z_1 - \mu_0\varepsilon z_1^3), \end{aligned}$$

where $P(z) = h_2(z)(-1)$. For notational convenience, we denote by m_1, m_2 and m_3 respectively $a(-1), b(-1)$ and $c(-1)$, where $a, b, c \in X_s$ denote the coefficients of $h_2(z)$. Now, we shall exploit relations (i),(ii) and (iii) to derive a Lyapunov function F :

Relation (i) implies that

$$F_2(z) = r(z_1^2 + z_2^2), \quad \text{for } r \in \mathbb{R}.$$

Without loss of generality, we put $r = 1$. Relation (ii) implies that

$$F_3(z) = 4\mu_0\alpha \left[\frac{2}{3\pi}z_1^3 - z_1^2z_2 - \frac{2}{3}z_2^3 \right].$$

Finally, if we define

$$F_4(z) = a_1 z_1^4 + a_2 z_1^3 z_2 + a_3 z_1^2 z_2^2 + a_4 z_1 z_2^3 + a_5 z_2^4,$$

then, the relation (iii) is equivalent to

$$\begin{cases} \frac{\pi}{2} a_2 - 2\pi (2\mu_0 \alpha m_1 + \varepsilon \mu_0) & = G_3 \\ \frac{\pi}{2} (2a_3 - 4a_1) - 4\mu_0 \alpha (\pi m_2 + 2m_1) - 4\varepsilon \mu_0 - 8\pi (\mu_0 \alpha)^2 & = 0 \\ \frac{\pi}{2} (3a_4 - 2a_2) - 4\mu_0 \alpha (2m_2 + \pi m_3) - 16 (\mu_0 \alpha)^2 & = 2G_3 \\ \frac{\pi}{2} (4a_5 - 2a_3) - 8m_3 \mu_0 \alpha & = 0 \\ -\frac{\pi}{2} a_4 & = G_3, \end{cases}$$

which implies that

$$G_3(\varepsilon, \alpha) = G_3 = -2\mu_0^2 \alpha^2 + \left(-\frac{3\pi}{2} \mu_0 m_1 - \mu_0 (2m_2 + \pi m_3) \right) \alpha - \frac{3\pi}{4} \varepsilon \mu_0. \tag{4.66}$$

So, by substituting the values of m_i given in corollary 8 in (4.66), it follows that

$$G_3(\varepsilon, \alpha) = \lambda \alpha^2 - \frac{3\pi}{4} \varepsilon \mu_0, \tag{4.67}$$

where $\lambda = \frac{\mu_0}{5} \left(\frac{8}{5\pi} - 13 \right) < 0$. Hence, from the study of the sign of $G_3(\varepsilon, \alpha)$ with respect to the parameters (ε, α) , the assertions of the proposition follow immediately. ■

Remarks: i) The map α_0 in the previous proposition 33 is defined by $\alpha_0(\varepsilon) = \delta \sqrt{|\varepsilon|}$, for $\varepsilon \in \mathbb{R}^-$, where $\delta = \sqrt{-\frac{3\pi\mu_0}{4\lambda}}$ and λ is the constant given above.

ii) By virtue of the previous proposition, we distinguish two main parts S_1 and S_2 of the parameter space \mathbb{R}^2 (see Fig 1), such that $G_3(\varepsilon, \alpha) < 0$ for $(\varepsilon, \alpha) \in S_1$ and $G_3(\varepsilon, \alpha) > 0$ for $(\varepsilon, \alpha) \in S_2$.

Theorem 9 Assume that hypothesis **(H)** is satisfied. Then, for each $(\varepsilon, \alpha) \in S_1 \cup S_2$, there exist $r_0 = r_0(\varepsilon, \alpha) > 0$ and $\beta_0 = \beta_0(\varepsilon, \alpha) > 0$ such that for every $\beta \in]-\beta_0, \beta_0[$, the following assertions hold

i) Equation (4.47) has exactly one periodic solution in $B(0, r_0)$ if $\beta G_3(\varepsilon, \alpha) < 0$.

ii) Equation (4.47) has no periodic solution in $B(0, r_0)$ if $\beta G_3(\varepsilon, \alpha) > 0$.

Proof : By virtue of proposition 33, it follows that, if $\beta = 0$, the system (4.62) is 3-asymptotically stable if $G_3(\varepsilon, \alpha) < 0$ (in other words if $(\varepsilon, \alpha) \in S_1$). Hence, by the generalized Hopf bifurcation theorem 3, there exists $r_0 = r_0(\varepsilon, \alpha) > 0$ and $\beta_0 = \beta_0(\varepsilon, \alpha) > 0$ such that the system (4.48) has exactly one periodic solution in $B(0, r_0)$ if

$$Re\lambda(\beta, \alpha, \varepsilon) G_3(\varepsilon, \alpha) < 0, \quad (4.68)$$

where $Re\lambda(\beta, \alpha, \varepsilon)$ is the real part of the two eigenvalues of the linear part of (4.62). However, $Re\lambda(\beta, \alpha, \varepsilon) = \frac{1}{2}\mu_0\pi\beta$, then, relation (4.68) is equivalent to $\beta G_3(\varepsilon, \alpha) < 0$, which completes the proof of the first assertion .

The proof of the second assertion is similar. In fact, by theorem 3, there exists $r_0 = r_0(\varepsilon, \alpha) > 0$ and $\beta_0 = \beta_0(\varepsilon, \alpha) > 0$ such that the system (4.48) has no periodic solution in $B(0, r_0)$ if $Re\lambda(\beta, \alpha, \varepsilon) G_3(\varepsilon, \alpha) > 0$. However, $sign(Re\lambda(\beta, \alpha, \varepsilon)) = sign(\beta)$, which yields the second assertion. ■

In conclusion, we can state as a corollary the following immediate consequences of theorem 9 regarding the direction of bifurcation.

Corollary 10 *Assume that hypothesis (H) is satisfied. Then, the bifurcation of nontrivial periodic solutions of (4.47) arising from $\gamma = \frac{\pi}{2}$ is*

- i) subcritical if $\varepsilon < 0$ and $|\alpha|$ is small enough.*
- ii) supercritical if either $\varepsilon < 0$ and $|\alpha|$ is larger than some value, or $\varepsilon < 0$ and for all α .*

Thus, the quadratic term pushes the bifurcation to the right, no matter its sign is. Subcriticality is caused by the cubic term and occurs only when the coefficient of this term is negative and large enough in absolute value.

Similar computations have been performed in the case $\gamma < 0$ (that is, positive feedback). There is little change in the formulae, for example, bifurcation occurs at $\gamma = -\frac{3\pi}{2}$. The results on the direction of bifurcation are as follows : the quadratic term acts in the same way as in the negative feedback case, while the cubic term has an opposite effect.

Chapter 6

AN ALGORITHMIC SCHEME FOR APPROXIMATING CENTER MANIFOLDS AND NORMAL FORMS FOR FUNCTIONAL DIFFERENTIAL EQUATIONS

M. Ait Babram

University Cadi Ayyad , Marrakech, Morocco.

`babram@ucam.ac.ma`

1. Introduction

Normal forms theory is one of the most powerful tools in the study of nonlinear dynamical systems, in particular, for stability and bifurcation analysis. In the context of finite-dimensional ordinary differential equations (ODEs), this theory can be traced back to the work done a hundred years ago by Poincaré [14]. The basic idea of normal form consists of employing successive, near-identity, nonlinear transformations, which leads us to a differential equation in a simpler form, qualitatively equivalent to the original system in the vicinity of a fixed equilibrium point, thus hopefully greatly simplifying the dynamical analysis.

Concerning functional differential equations (FDEs), the principal difficulty in developing normal form theory is the fact that the phase space is not finite dimensional. The first work in this direction, in such a way to overcome this difficulty, is due to T. Faria et al. [44]. In that paper, the authors have considered an FDE as an abstract ODE in an adequate infinite-dimensional phase space which was first presented in the work of Chow and Mallet-Paret [30]. This infinite dimensional ODE is then handled in a similar way as in the finite dimensional case, and through a recursive process of nonlinear transformations, the authors in [44] succeeded to a simpler infinite dimensional ODE so defined as normal form of the original FDE. One of [44]'s proposal is that, for fear of losing the explicit relationships between the coefficients in the normal form obtained and the coefficients in the original FDE, their method provides

us an efficient algorithm for approximating normal forms for an FDE directly without computing beforehand a local center manifold near the singularity. However, by expliciting steps of the algorithm given in [4], we will show that the known of Taylor coefficients of the center manifold is necessary for the algorithm to go on. This point of view will be presented in detail later.

The issue of this chapter is to present a new, efficient and algorithmic formulation of the problem of computing local center manifolds and normal forms associated to an FDE. The problem have been considered in the previous papers [2] and [1], but only in approximating local center manifold associated to an FDE with special singularities (namely Hopf and Bogdanov-Takens singularities). In this work, we are concerned with FDEs having a general singularity. We assume that the existence of a local center manifold is ensured by finitely many eigenvalues with zero real part. The result generalizes singularities considered in both of the works [2] and [1]. Our motivations for this work are two folds. First, we derive an algorithmic scheme which allows us, by means of a recursive procedure, to compute at each step the term of order $k \geq 2$ of the Taylor expansion of a local center manifold : In fact, we prove that the coefficients of the homogeneous part of degree k of a local center manifold satisfy an initial value problem in finite dimension, whose parameters depend only on terms of the same order in the considered FDE and the terms of lower order of a local center manifold already computed. Note that the computation of Taylor expansion is, in most cases, the only information that can be extracted at the expense of nontrivial algorithmic procedures. Secondly, we present an algorithm which provides us, in a recursive way, with the normal form of an FDE. This is accomplished in three steps. In the first step we consider the reduced system on a known local center manifold for which an algorithmic scheme is developed. This gives us idea about information needed from a local center manifold in order to compute terms of the normal form for the reduced system. This allows, in the second step, a simpler scheme that greatly saves computational times and computation memory. Finally, in the third step we present a direct computing scheme of normal forms for FDEs (in the sense of the definition given in [44]).

The chapter is organized as follows: The preliminary section 2 provides us with elementary notions and a background about the theory of FDEs (for more details see [58]). In section 3, we state a result which gives us an analytic characterization of a local center manifold. This characterization is then explored to derive a computational scheme of a local center manifold, and we consider some applications of the computation of center manifolds to the special cases of the Hopf singularity and

Bogdanov Takens singularity respectively. We remind the reader that a concrete example related to the Hopf singularity had been discussed in the last chapter. An example related to the Bogdanov Takens singularity is given in the end of this section. Section 4 details the normal form construction for both of the reduced system and the original FDE.

2. Notations and background

In this section, we refer the reader to [53] for notations and general results on the theory of FDEs in finite dimension spaces. Let $r \geq 0$ and $n \in \mathbb{N}$. We denote by $C = C([-r, 0], \mathbb{R}^n)$ the Banach space of continuous functions from $[-r, 0]$ to \mathbb{R}^n endowed with the supremum norm $\|\phi\| = \sup_{\theta \in [-r, 0]} |\phi(\theta)|$, for $\phi \in C$. If u is a continuous function taking $[\sigma - r, \sigma + a]$ into \mathbb{R}^n , then we denote by u_t the element of C defined by $u_t(\theta) = u(t + \theta)$, for every $\theta \in [-r, 0]$ and $t \in [\sigma, \sigma + a]$. Our main concern throughout this paper is with the autonomous FDE of the form

$$\frac{du(t)}{dt} = Lu_t + f(u_t) \tag{2.1}$$

where L is a bounded linear operator from C into \mathbb{R}^n and f is a sufficiently smooth function mapping C into \mathbb{R}^n such that $f(0) = 0$ and $Df(0) = 0$ (Df denotes the Fréchet derivative of f). A solution $u = u(\phi)$ of (1) through a point ϕ in C is a continuous function taking $[-r, a]$, into \mathbb{R}^n such that $x_0 = \phi$ and satisfying (1) for t in $(0, a)$. Note that the Riesz representation allows us to represent the operator L as

$$L(\phi) = \int_{-r}^0 d\eta(\theta) \phi(\theta)$$

where η is an $n \times n$ matrix valued function of bounded variation in $\theta \in [-r, 0]$.

Together with (1), we consider the linearized equation near zero

$$\frac{du(t)}{dt} = Lu_t \tag{2.2}$$

If we denote by $u(\cdot, \phi)$ the unique solution of equation (2.2) with initial function ϕ at zero, then equation (2.2) determines a C_0 -semigroup of bounded linear operators given by

$$T(t)\phi = u_t(\cdot, \phi), \quad \text{for } t \geq 0$$

where u is the solution of (2.2) with $u_0 = \phi$. Denote by A the infinitesimal generator of $(T(t))_{t \geq 0}$. It is known that the spectrum $\sigma(A)$ of A

coincides with its point spectrum $\sigma_p(A)$ and it consists of those $\lambda \in \mathbf{C}$ which satisfy the characteristic equation

$$p(\lambda) = \det \Delta(\lambda) = 0 \tag{2.3}$$

where $\Delta(\lambda) = \lambda I_{R^n} - \int_{-r}^0 e^{\lambda \theta} d\eta(\theta)$.

Let $m \in N$ be the number of solutions of (2.3) with zero real part, counting their multiplicities. Denote by $\Lambda = \{\lambda_i, i = 1, \dots, m\}$ this set of eigenvalues. Throughout this paper, we assume that the following hypothesis holds:

$$\mathbf{(H)} \quad \Lambda \neq \emptyset.$$

Using the formal adjoint theory of Hale [53], the phase space C is decomposed by Λ as

$$C = P_\Lambda \oplus Q_\Lambda,$$

where P_Λ is the m dimensional generalized eigenspace associated to elements of Λ and Q_Λ is its unique $T(t)$ invariant complement subspace in C . If we denote by $\Phi = (\phi_1, \phi_2, \dots, \phi_m)$ a basis of P_Λ , the subspace P_Λ is then written as

$$P_\Lambda = \{\Phi x : x \in R^m\}.$$

Moreover, according to the hypothesis $\mathbf{(H)}$, there exists a matrix B of the form

$$B = \begin{bmatrix} \lambda_1 & \sigma_1 & 0 & \cdots & 0 \\ 0 & \lambda_2 & & \ddots & \vdots \\ \vdots & \ddots & \ddots & & 0 \\ \vdots & & \ddots & \ddots & \sigma_{m-1} \\ 0 & \cdots & \cdots & 0 & \lambda_m \end{bmatrix} \tag{2.4}$$

with $\sigma_i \in \{0, 1\}$ such that the semi-flow generated by (2.2) restricted to P_Λ is a linear ODE whose matrix is exactly B . To explicit the subspace Q_Λ and the projection operator associated with the above decomposition of C we need to define the so called adjoint bilinear form as

$$\langle \psi, \varphi \rangle = \psi(0) \varphi(0) - \int_{-r}^0 \int_0^\theta \psi(s - \theta) d\eta(\theta) \varphi(s) ds, \text{ for } \varphi \in C \text{ and } \psi \in C^* \tag{2.5}$$

where $C^* = C([0, r], R^{n*})$ and R^{n*} is the n -dimensional space of row vectors. With the this bilinear form we can compute the basis $\Psi = \text{col}(\psi_1, \psi_2, \dots, \psi_m)$ of the dual space P_Λ^* in C^* such that $\langle \Psi, \Phi \rangle = (\langle \psi_i, \phi_j \rangle)_{0 \leq i, j \leq m} = I_{R^n}$. and, the subspace Q_Λ is given in a compact form:

$$Q_\Lambda = \{\phi \in C : \langle \Psi, \phi \rangle = \text{col}(\langle \psi_1, \phi \rangle, \dots, \langle \psi_m, \phi \rangle) = 0\}.$$

Now consider the nonlinear equation (2.1). Using the variation of constants formula given in [53], a solution of (2.1) is given by

$$u_t = T(t) u_0 + \int_0^t T(t-s) X_0 f(u_s) ds, \quad \text{for } t \geq 0$$

where $X_0 = X_0(\theta)$ is defined by

$$X_0(\theta) = \begin{cases} I_{R^n} & \text{for } \theta = 0 \\ 0 & \text{for } \theta \in [-r, 0[\end{cases}$$

According to the decomposition of C endowed by the set Λ of eigenvalues, the solution u_t given above may be decomposed as $u_t = \Phi x(t) + y(t)$, where $x(t)$ is an element of R^m and $y(t) \in Q_\Lambda$. It is important to observe that in general $y(t)$ does not satisfy the translation property (ie $y(t)(\theta) = y(t+\theta)(0)$).

By the use of a fixed point theorem, the authors in [53] have considered equation (2.1) for which they proved that, under hypothesis **(H)**, we have the existence of a local center manifold. This tool allows us to give a complete description of the local dynamics of equation (2.1) near the steady state: more precisely, the behavior of orbits of (2.1) in C can be completely described by the restriction of the flow to a local center manifold associated with Λ , which is necessarily an m -dimensional ODE. Note that the lack of uniqueness makes local center manifolds hard to determine. However, fortunately, the uniqueness of the Taylor expansion of these manifolds is ensured. After computing the Taylor expansion of a center manifold up to an order k , the nonlinear term of the reduced system can be explicitly computed up to the order $k + 1$. The classical definition of a local center manifold associated with the set Λ of eigenvalues in the imaginary axis is given as:

Definition 34 : Given a C^1 map h from R^m into Q_Λ , the graph of h is said to be a local center manifold associated with equation (1) if and only if $h(0) = 0$, $Dh(0) = 0$ and there exists a neighborhood V of zero in R^m such that, for each $z \in V$, there exists $\delta = \delta(\xi) > 0$ and the solution x of (2.1) with initial data $\Phi z + h(z)$ exists on the interval $]-\delta - r, \delta[$ and it is given by

$$u_t = \Phi x(t) + h(x(t)), \quad \text{for } t \in [0, \delta[,$$

where $x(t)$ is the unique solution of the ordinary differential equation

$$\begin{cases} \frac{dx(t)}{dt} = Bx(t) + \Psi(0) f(\Phi x(t) + h(x(t))) \\ x(0) = z, \end{cases} \tag{2.6}$$

with B is the matrix defined in (2.4). The ODE (2.6) is said to be the reduced system of (2.1).

Geometrically speaking, a local center manifold is the graph of a given function mapping a neighborhood of zero in P_Λ into Q_Λ which is tangent to P_Λ and locally invariant under the semi-flow generated by equation (2.1).

In [44], the authors have presented a method for computing normal forms for FDEs. To develop a normal form theory for FDEs, it was necessary, in the first step, to enlarge the phase space C in such a way that (2.1) is written as an abstract ODE. The adequate phase space for this situation is the one introduced in [55] and used in [28] for the application of averaging methods to FDEs. It is exactly the space BC of the functions from $[-r, 0]$ into R^n uniformly continuous on $[-r, 0[$ and with a jump discontinuity at 0. In terms of the function X_0 defined previously, an element $\psi \in BC$ can be written as $\psi = \phi + X_0\alpha$ where $\phi \in C$ and $\alpha \in R^n$. Also, if we identify the space BC to $C \times R^n$ then it can be endowed with the norm

$$\|\phi + X_0\alpha\|_{BC} = \|\phi\|_C + \|\alpha\|_{R^n}$$

to be a Banach space. The abstract ODE in BC associated with the FDE (2.1) can be written in the form

$$\frac{du(t)}{dt} = \tilde{A}u(t) + X_0f(u(t)) \quad (2.7)$$

where $\tilde{A}\phi = \phi' + X_0[L\phi - \phi'(0)]$ with $D(\tilde{A}) = C^1$. The bilinear form in $C^* \times C$ defined in (2.5) can be extended in a natural way to $C^* \times BC$ by $\langle \Psi, X_0 \rangle = \Psi(0)$, and consequently, we can define the projection operator $\pi : BC \rightarrow P_\Lambda$ such that

$$\pi(\phi + X_0\alpha) = \Phi[\langle \Psi, \phi \rangle + \Psi(0)\alpha] \quad \text{for every } \phi \in C \text{ and } \alpha \in R^n$$

leading to the decomposition

$$BC = P_\Lambda \oplus \text{Ker}(\pi)$$

Let u be a solution of (2.7). According to the above decomposition of BC , the solution u can be written

$$u(t) = \Phi x(t) + y(t)$$

where $x(t) \in \mathbb{R}^m$ and $y(t) \in \text{Ker}(\pi) \cap D(\tilde{A}) = Q_\Lambda \cap C^1 \triangleq Q^1$. As π commutes with \tilde{A} in C^1 , the equation (2.7) is equivalent to the system

$$\begin{cases} \frac{d}{dt}x(t) = Bx(t) + \Psi(0) f(\Phi x(t) + y(t)) \\ \frac{d}{dt}y(t) = \tilde{A}_1 y(t) + (I - \pi) X_0 f(\Phi x(t) + y(t)) \end{cases} \tag{2.8}$$

where \tilde{A}_1 is the restriction of \tilde{A} to Q^1 interpreted as an operator acting in the Banach space $\text{Ker}(\pi)$.

In applications, we are particularly interested in obtaining normal forms for equations giving the flow on local center manifolds. In the context of FDEs, typical equations to be considered for the computation of normal forms read as

$$\dot{x} = Bx + \Psi(0) f(\Phi x + h(x)), \tag{2.9}$$

where h is a local center manifold.

3. Computational scheme of a local center manifold

In this section, we derive, at first, necessary and sufficient analytic conditions on a given function h under which its graph is a local center manifold of (2.1). This will be exploited in the second step to develop the computational scheme of terms in the Taylor expansion of h .

Theorem 1 *Let h be a map from \mathbb{R}^m into Q_Λ with $h(0) = 0$ and $Dh(0) = 0$. A necessary and sufficient conditions on the graph of h to be a local center manifold of equation (2.1) is that there exists a neighborhood V of zero in \mathbb{R}^m such that, for each $z \in V$, we have*

$$\begin{aligned} \frac{\partial}{\partial \theta} (h(z))(\theta) &= \left(\frac{\partial h(z)}{\partial z}(\theta) \right) [Bz + \Psi(0) f(\Phi z + h(z))] \\ &+ \Phi(\theta) \Psi(0) f(\Phi z + h(z)). \end{aligned} \tag{3.10}$$

and

$$\frac{\partial h(z)}{\partial \theta}(0) = Lh(z) + f(\Phi z + h(z)), \tag{3.11}$$

where $z(t)$ is the unique solution of (2.6).

Proof. Necessity : If h is a local center manifold of equation (2.1), then, there exists a neighborhood V of zero in \mathbb{R}^2 such that, for each

$\xi \in V$, there exists $\delta = \delta(\xi) > 0$ such that the solution of (2.1) with initial data $\Phi\xi + h(\xi)$ exists on the interval $]-\delta - r, \delta[$ and it is given by

$$x_t = \Phi z(t) + h(z(t)), \text{ for } t \in]-\delta, \delta[.$$

The relations

$$\Phi(\theta) z(t) + h(z(t))(\theta) = \Phi(t + \theta)\xi + h(\xi)(t + \theta), \text{ for } t + \theta \leq 0 \text{ and } 0 \leq t < \delta, \tag{3.12}$$

and

$$\begin{aligned} \Phi(\theta) z(t) + h(z(t))(\theta) &= \Phi(0) z(t + \theta) + h(z(t + \theta))(0), \\ &\text{for } t + \theta \geq 0 \text{ and } 0 \leq t < \delta \end{aligned} \tag{3.13}$$

are immediately deduced from the translation property of the semi-flow $t \mapsto x_t = \Phi z(t) + h(z(t))$ generated by equation (2.1) in a local center manifold. Moreover, this semi-flow has a backward extension to $]-\delta, 0]$. Then, it follows from (3.13) that

$$L(\Phi\xi + h(\xi)) + f(\Phi\xi + h(\xi)) = \Phi B\xi + \frac{\partial h(\xi)}{\partial \theta}(0), \tag{3.14}$$

so, by using the property $L\Phi\xi = \Phi B\xi$, the relation (3.11) follows immediately.

On the other hand, for $t > 0$, by differentiating relation (3.12) with respect to t , we get

$$\begin{aligned} \Phi(t + \theta) B\xi + \frac{\partial}{\partial \theta}(h(\xi))(t + \theta) &= \left[\Phi(\theta) + \frac{\partial h(z(t))}{\partial \xi}(\theta) \right] \\ &\times [Bz(t) + \Psi(0) f(\Phi z(t) + h(z(t)))] \end{aligned}$$

Let t go to zero. Then,

$$\begin{aligned} \frac{\partial}{\partial \theta}(h(\xi))(\theta) &= \left(\frac{\partial h(\xi)}{\partial \xi}(\theta) \right) [B\xi + \Psi(0) f(\Phi\xi + h(\xi))] \\ &+ \Phi(\theta) [\Psi(0) f(\Phi\xi + h(\xi))]. \end{aligned} \tag{3.15}$$

Sufficiency : From the formulae (3.12) and (3.13), one can see that there exists a continuous function $y :]\delta - r, \delta[\rightarrow \mathbb{R}^n$ such that

$$y_t = \Phi z(t) + h(z(t)), \text{ for } t \in]-\delta, \delta[.$$

So, it remains to prove that y is a solution of (2.1). In fact,

$$\frac{d}{dt}y(t) = \left(\Phi(0) + \frac{\partial h(z(t))}{\partial \xi}(0) \right) \frac{dz(t)}{dt} \tag{3.16}$$

Letting $\xi = z(t)$ and $\theta = 0$ in (3.15) and substituting $\frac{\partial}{\partial \theta}(h(z(t)))(\theta)$ for the right hand side of (3.15) into (3.16), we obtain

$$\begin{aligned} \frac{d}{dt}y(t) &= \Phi(0)Bz(t) + \frac{\partial h(z(t))}{\partial \theta}(0) \\ &= L(y_t) + f(y_t), \end{aligned}$$

which completes the proof of the theorem. ■

And in the case of neutral functional differential equations of the form

$$\frac{d}{dt}[D(x_t) - G(x_t)] = Lx_t + F(x_t), \tag{3.17}$$

where L and D are bounded linear operators from \mathcal{C} into \mathbb{R}^n ; F and G are sufficiently smooth functions mapping \mathcal{C} into \mathbb{R}^n such that $F(0) = G(0) = 0$ and $F'(0) = G'(0) = 0$ (F' and G' denote the Frechet derivative of F and G respectively), the analytic characterization of a local center manifold is given in the following corollary:

Corollary 2 *Let h be a map from \mathbb{R}^m into Q_Λ with $h(0) = 0$ and $Dh(0) = 0$. A necessary and sufficient conditions on the graph of h to be a local center manifold of equation (3.17) is that there exists a neighborhood V of zero in \mathbb{R}^m such that, for each $z \in V$, we have*

$$\begin{aligned} \frac{\partial}{\partial \theta}(h(z))(\theta) &= \left(\frac{\partial h(z)}{\partial z}(\theta) \right) [Bz + \Psi(0)F(\Phi z + h(z)) + B\Psi(0)G(\Phi z + h(z))] \\ &\quad + \Phi(\theta) [\Psi(0)f(\Phi z + h(z)) + B\Psi(0)G(\Phi z + h(z))]. \end{aligned}$$

and

$$\begin{aligned} D \left(\frac{\partial h(\xi)}{\partial \theta} \right) &= Lh(\xi) + F(\Phi\xi + h(\xi)) \\ &\quad + G'(\Phi\xi + h(\xi)) \left(\Phi B\xi + \frac{\partial h(\xi)}{\partial \theta} \right) \end{aligned}$$

3.1 Formulation of the scheme

Now we are in position to derive our algorithmic scheme for approximating a local center manifold associated with (2.1). To this end consider the analytic characterization given in the above Theorem. Without loss of generality we can assume that h and f can be written respectively in the form:

$$h(z) = \sum_{j \geq 2} h_j(z) \tag{3.18}$$

and

$$f(\phi) = \sum_{j \geq 2} f_j(\phi) \tag{3.19}$$

The term $h_j(z)$ denotes the homogeneous part of degree j with respect to z of h .

In the sequel of this work we adopt the following notation : for $j \in \mathbb{N}$ and Y a normed space, $V_j^m(Y)$ denotes the space of homogeneous polynomials of degree j in m variables $z = (z_1, z_2, \dots, z_m)$ with coefficients in Y . In other words

$$V_j^m(Y) = \left\{ \sum_{|q|=j} c_q z^q : q \in \mathbb{N}^m, c_q \in Y \right\}$$

where $|q| = \sum_{i=1}^m q_i$. Moreover, we denote by D_j^m the set of parameters defined as

$$D_j^m = \left\{ q = (q_1, q_2, \dots, q_m) \in \mathbb{N}^m : |q| = \sum_{i=1}^m q_i \right\}$$

endowed with the following order : for $q = (q_1, q_2, \dots, q_m)$ and $p = (p_1, p_2, \dots, p_m)$ in D_j^m , we have $p < q$ if the first non-zero difference $p_1 - q_1, p_2 - q_2, \dots, p_m - q_m$ is positive. Hence, the space D_j^m reads

$$D_j^m = \left\{ q^{(m,j,i)} : i = 1, \dots, \bar{j} \right\},$$

where $\bar{j} = \text{card}(D_j^m)$ and $q^{(m,j,1)} < q^{(m,j,2)} < \dots < q^{(m,j,\bar{j})}$.

The goal now is to develop our algorithmic scheme for computing, in a recursive way, the polynomial $(h_j)_{j \geq 2}$. We will show that at the step $k \geq 2$, the term $h_k \in V_k^m(Q_\Lambda)$ is computed from the terms of lower orders already computed (ie $(h_j)_{2 \leq j \leq k-1}$) and from the terms of lower order of f .

Fix $k \in \mathbb{N}$. Assume that steps of order $2, \dots, k - 1$ are already performed (ie the terms $(h_j)_{2 \leq j \leq k-1}$ are known). By dropping the parameters k and m in the above notation for simplicity of formulae, the space D_k^m is written as

$$D_k^m = \{q^i : i = 1, \dots, \bar{k}\}$$

and as a consequence the space $V_k^m(Y)$ can be written

$$V_k^m(Y) = \left\{ \sum_{i=1}^{\bar{k}} c_i z^{q^i} : c_i \in Y \right\}.$$

The homogeneous part of degree k with respect to z of equation (3.10) is given by

$$\frac{\partial h_k(z)}{\partial \theta} = \frac{\partial h_k(z)}{\partial z} Bz + F^k(z), \tag{3.20}$$

where $F^k(z)$ is an element of $V_k^m(C)$ given by

$$F^k(z) = \sum_{i=2}^{k-1} \frac{\partial h_{k-i+1}(z)}{\partial z} \Psi(0) H_i(z) + \Phi \Psi(0) H_k(z)$$

where $H_i \in V_i^m(R^n)$ is the homogeneous part of degree i with respect to z of $H(z) = f(\Phi z + h(z))$. An exact formula of H_i is given by the following proposition :

Proposition 34 *Under the standing hypothesis (H), it follows that*

$$\begin{aligned} H_i(z) = & f_i(\Phi z) + \sum_{j=2}^{i-1} Df_j(\Phi z) h_{i+1-j}(z) \\ & + \sum_{j=2}^{\lfloor \frac{i}{2} \rfloor} \frac{1}{j!} \sum_{p=j}^{i-j} D^j f_p(\Phi z) \left\{ \sum_{l_1+l_2+\dots+l_j=i-(p-j)} h_{l_1} h_{l_2} \dots h_{l_j} \right\}(z) \end{aligned} \tag{3.21}$$

for all $i \geq 2$.

Proof. Using the Taylor expansion of $H(z) = f(\Phi z + h(z))$ near $h = 0$ results in

$$H(z) = f(\Phi z) + Df(\Phi z) h(z) + \sum_{i \geq 2} \frac{1}{i!} D^i f(z) [h(z)]^i.$$

So, according to the representations (3.18) and (3.19), the above equation reads

$$\begin{aligned} \sum_{j \geq 2} H_j(z) = & \sum_{i \geq 2} f_i(\Phi z) + \sum_{i \geq 2} \sum_{j \geq 2} Df_j(\Phi z) h_i(z) \\ & + \sum_{i \geq 2} \frac{1}{i!} \sum_{j \geq 2} D^j f_j(\Phi z) \left[\sum_{l \geq 2} h_l \right]^i. \end{aligned} \tag{3.22}$$

Finally comparing the same order terms of (3.22) yields us the result of the proposition. ■ ■

Remark 3 $F^k(z)(\theta)$ is an element of $V_k^m(R^m)$. So, according to the above notation, the homogenous polynomial $F^k(z)$ can be written as

$$F^k(z)(\theta) = \sum_{i=1}^{\bar{k}} F_i^k(\theta) z^{q^i}, \tag{3.23}$$

where F_i^k are elements of C . The above proposition provides us with a clear relationship between $F^k(z)$ and the terms of h (already computed) as well as the terms of the nonlinearity f of the original FED

In the same way as above, by comparing the k -order terms of (3.11), we obtain

$$\frac{\partial h_k(z)}{\partial \theta}(0) = Lh_k(z) + H_k(z). \tag{3.24}$$

In the sequel of this section we will be concerned only with the equations (3.20) and (3.24). By identifying coefficients of the both sides of (3.20) and (3.24) in the basis $(z^{q^i})_{1 \leq i \leq \bar{k}}$ an adequate formulation of computing the term $h_k(z) \in V_k^m(Q_\Lambda)$ will be derived

Remark 4 Let $l(z) = z^{q^i}$ with $q^i = (q_1^i, q_2^i, \dots, q_m^i)$ an element of D_k^m . If we denote by $I_i = \{j \in N : p_j^i = q^i + e_{j+1} - e_j \in D_k^m\}$, then it is easy to see that

$$Dl(z)Bz = \mu^i z^{q^i} + \sum_{j \in I_i} q_j^i \sigma_j z^{p_j^i}.$$

where $\mu^i = (q^i, \bar{\lambda}) = \sum_{j=1}^{\bar{k}} q_j^i \lambda_j$. Moreover we have

$$p_j^i > q^i, \quad \text{for all } i \in \{1, \dots, \bar{k}\} \text{ and } j \in I_i.$$

First, we put

$$h_k(z) = \sum_{i=1}^{\bar{k}} a_i^k z^{q^i} \text{ and } X^k = \text{col} \left[a_1^k, a_2^k, \dots, a_{\bar{k}}^k \right],$$

where the a_i^k are elements of Q_Λ . So according to the above remark and by identifying the two members of (3.20) in the space of homogeneous polynomial in $z = (z_1, z_2, \dots, z_m)$ of degree k with coefficients in Q_Λ it leads

$$\frac{dX^k(\theta)}{d\theta} = A_k X^k(\theta) + F^k(\theta), \text{ for } \theta \in [-r, 0] \tag{3.25}$$

where

$$A_k = \begin{bmatrix} \mu^1 \mathbf{I}_{\mathbb{R}^n} & 0 & 0 & \cdots & \cdots & 0 \\ \star & \mu^2 \mathbf{I}_{\mathbb{R}^n} & \ddots & \ddots & & \vdots \\ \star & \star & \ddots & \ddots & \ddots & \vdots \\ \vdots & \ddots & \ddots & \ddots & 0 & 0 \\ \vdots & & \ddots & \star & \mu^{\bar{k}-1} \mathbf{I}_{\mathbb{R}^n} & 0 \\ \star & \cdots & \star & \star & \star & \mu^{\bar{k}} \mathbf{I}_{\mathbb{R}^n} \end{bmatrix} \tag{3.26}$$

and

$$F^k(\theta) = \text{col} \left[F_1^k(\theta), F_2^k(\theta), \dots, F_{\bar{k}}^k(\theta) \right], \text{ for } \theta \in [-r, 0].$$

Secondly, consider the second equation (3.24). If we put

$$H_k(z) = \sum_{i=1}^{\bar{k}} M_i^k z^{q^i}, \text{ for } M_j^k \in \mathbb{R}^n,$$

then, in a vector representation, the equation (3.24) reads

$$\frac{dX^k(0)}{d\theta} - LX^k = M^k, \tag{3.27}$$

where

$$M^k = \text{col} \left[M_1^k, M_2^k, \dots, M_{\bar{k}}^k \right].$$

The variation of constants formula applied to the ordinary differential equation (3.25) yields

$$X^k(\theta) = \exp(\theta A_k) X^k(0) + S^k(\theta), \text{ for } \theta \in [-r, 0] \tag{3.28}$$

where

$$S^k(\theta) = \int_0^\theta \exp((\theta - s) A_k) F^k(s) ds.$$

So, by substituting the above expression of X^k into the relation (3.27), it follows that the vector $X^k(0)$ is a solution of the linear system

$$B_k X^k(0) = E^k, \tag{3.29}$$

where,

$$B_k = A_k - L(\exp(\cdot A_k)) \tag{3.30}$$

and

$$E^k = M^k - F^k(0) - LS^k. \tag{3.31}$$

Then, Substituting (3.26) into (3.30) yields the matrix B_k in the form:

$$B_k = \begin{bmatrix} \Delta(\mu^1) & 0 & 0 & \cdots & \cdots & 0 \\ \star & \Delta(\mu^2) & \ddots & \ddots & & \vdots \\ \star & \star & \ddots & \ddots & \ddots & \vdots \\ \vdots & \ddots & \ddots & \ddots & 0 & 0 \\ \vdots & & \ddots & \star & \Delta(\mu^{\bar{k}-1}) & 0 \\ \star & \cdots & \star & \star & \star & \Delta(\mu^{\bar{k}}) \end{bmatrix} \tag{3.32}$$

where $\Delta(\cdot)$ is the characteristic matrix defined in the preliminary section.

Summarizing, we have shown that the part of degree k of the function h satisfies the following initial value problem :

$$\begin{cases} \frac{dX^k(\theta)}{d\theta} &= A_k X^k(\theta) + F^k(\theta), \text{ for } \theta \in [-r, 0] \\ B_k X^k(0) = E^k & \text{with } X^k \in (Q_\Lambda)^{\bar{k}}. \end{cases} \tag{3.33}$$

In which F^k and E^k are determined in terms h_2, \dots, h_{k-1} of h and the terms f_2, \dots, f_k of f .

Remark 5 *It is noted that the matrix B_k need not to be nonsingular. So, in order to compute the initial data $X^k(0)$ of the problem (2.1), we should take into account the abstract condition $X^k \in (Q_\Lambda)^{\bar{k}}$. The only way to do that is the formal adjoint theory defined in the preliminary section. More precisely, a solution of (3.33) must satisfy $\langle \Psi, X^k \rangle = 0$. As a consequence, the vector $X^k(0)$ should be a solution of a system of two systems*

$$C_k X^k(0) = N^k \quad \text{and} \quad B_k X^k(0) = E^k$$

where $N^k = -\langle \Psi, S^k \rangle$ and $C_k = \langle \Psi, \exp(\cdot A_k) \rangle$ is the $n(k+1) \times m(k+1)$ matrix given by

$$C_k = \begin{bmatrix} \langle \Psi, \exp(\cdot \mu^1) \mathbf{I}_{\mathbb{R}^n} \rangle & 0 & 0 & \cdots & 0 \\ \star & \langle \Psi, \exp(\cdot \mu^2) \mathbf{I}_{\mathbb{R}^n} \rangle & \ddots & & \vdots \\ \star & \star & \ddots & \ddots & \vdots \\ \vdots & \ddots & \ddots & 0 & 0 \\ \star & \cdots & \star & \star & \langle \Psi, \exp(\cdot \mu^{\bar{k}}) \mathbf{I}_{\mathbb{R}^n} \rangle \end{bmatrix} \tag{3.34}$$

According to the above remark, the system (3.33) reads

$$\begin{cases} \frac{dX^k(\theta)}{d\theta} &= A_k X^k(\theta) + F^k(\theta), \text{ for } \theta \in [-r, 0] \\ B_k X^k(0) = E^k &\text{ and } C_k X^k(0) = N^k. \end{cases} \quad (3.35)$$

Finally, one can see that equation (3.35) is all what can be extracted from the coefficients of h_k . That's why, our interest will be focused in the well posedness of problem (3.35). The following result provides us with the complete scheme of computing the homogeneous part of degree k of a local center manifold.

Theorem 3 *Let $(a_i^k)_{i=1, \dots, \bar{k}}$ be the family of the coefficients of the graph representation of any local center manifold associated with equation (2.1), in the basis $(z^{q^i})_{i=1, \dots, \bar{k}}$ of the polynomials of degree k with coefficient in Q_Λ . Then, the $(a_i^k)_{i=1, \dots, \bar{k}}$ are uniquely determined by the equation (3.35), in which the F^k are given by (3.23), E^k by (3.31) and B_k by (3.30).*

Proof. In view of the above computations, one can see that if $(a_i^k)_{i=1, \dots, \bar{k}}$ is such a family of coefficients then, it satisfies equation (3.35). What remains to be seen is that equation (3.35) leads to a unique set of coefficients that is, no additional information or equation is necessary for the computation the k -th term in the Taylor expansion of h . To this end, it is sufficient to prove that $Y^k \equiv 0$ is the unique solution of the problem

$$\begin{cases} \frac{dY^k(\theta)}{d\theta} &= A_k Y^k(\theta), \text{ for } \theta \in [-r, 0] \\ B_k Y^k(0) = 0 &\text{ and } C_k Y^k(0) = 0. \end{cases} \quad (3.36)$$

In other words, it suffices to prove that $Y^k(0) = 0$ is the unique solution of the two systems

$$B_k Y^k(0) = 0 \text{ and } C_k Y^k(0) = 0. \quad (3.37)$$

So, we have to prove that the kernel of the bloc matrix $\begin{bmatrix} B_k \\ C_k \end{bmatrix}$ is exactly zero. To this end, we distinguish two cases: In the first case we assume that $\mu^i \notin \Lambda$ for all $i \in \{1, 2, \dots, \bar{k}\}$. Fix $i \in \{1, 2, \dots, \bar{k}\}$. Since $\Re(\mu^i) =$

0, then, the characteristic matrix $\Delta(\mu^i)$ is nonsingular. So, in view of the form (3.30) of the matrix B_k , it follows that $Ker(B_k) = \{0\}$. Or

$$Ker \left(\begin{bmatrix} B_k \\ C_k \end{bmatrix} \right) = Ker(B_k) \cap Ker(C_k) = \{0\}.$$

This implies that $Y^k(0) = 0$ and thus $Y^k \equiv 0$ is the unique solution of the problem (3.36). In the second case we assume that for all i in a subset $J_{\bar{k}} \subset \{1, 2, \dots, \bar{k}\}$, the value μ^i coincides with an element of Λ . To conclude the proof of the theorem we need the following lemma. ■

Lemma 28 *Assume that for $i \in J_{\bar{k}} \subset \{1, 2, \dots, \bar{k}\}$, μ^i coincides with an element of Λ . Then, there exist a nonsingular $n\bar{k} \times n\bar{k}$ matrix D_k such that the boundary condition (3.37) can be written as*

$$D_k Y^k(0) = 0,$$

where D_k is a matrix that can be constructed by mixing terms of B_k and those of C_k .

Proof. Consider the mapping $\alpha : J_{\bar{k}} \ni i \mapsto \alpha(i) \in \{1, 2, \dots, m\}$, such that $\lambda_{\alpha(i)} = \mu^i$. Then $\phi_{\alpha(i)}(\theta) = \exp(\theta\mu^i)$ and $\langle \psi_{\alpha(i)}, \phi_{\alpha(i)} \rangle = 1$. When $n = 1$ (the scalar case), we have $\Delta(\mu^i) = 0$ for $i \in J_{\bar{k}}$. So, if we denote by D_k the matrix obtained from B_k and C_k by replacing the rows $i \in J_{\bar{k}}$ of B_k with the rows $(i + \alpha(i)) \in \{1, 2, \dots, m\bar{k}\}$ of C_k respectively. Then it is easy to see that D_k is invertible. Thus, the boundary conditions (3.37) is equivalent to $D_k Y^k(0) = 0$. In the non-scalar case ($n > 1$), it is difficult to guess exactly the rows that we should eliminate from the matrix B_k and the ones that we can bring from the matrix C_k in order to build the invertible matrix D_k . But it is easy to prove that the kernel of the block matrix $\begin{bmatrix} B_k \\ C_k \end{bmatrix}$ is reduced to zero. In fact, let $b = col(b^1, b^2, \dots, b^{\bar{k}})$ an element of $\mathbf{C}^{n\bar{k}}$ such that $B_k b = 0$ and $C_k b = 0$. In an induction procedure, we will show that $b^i = 0$ for all $i \in \{1, 2, \dots, \bar{k}\}$. In view of (3.32) and (3.34), it follows that b^1 satisfies

$$\begin{cases} \Delta(\mu^1) b^1 = 0 \\ \langle \Psi, \exp(\cdot\mu^1) b^1 \rangle = 0 \end{cases} \tag{3.38}$$

Note that μ^i is a complex element with zero real part. So, by virtue of (3.38), if $\mu^1 \notin \Lambda$ then $\Delta(\mu^1)$ is non-singular and $b^1 = 0$ and if not (ie. $\mu^1 \in \Lambda$) then $\Delta(\mu^1) b^1 = 0$ implies that $\exp(\cdot\mu^1) b^1$ is an eigenfunction A associated to the eigenvalues $\mu^1 = \lambda_{\alpha(1)}$. Or, $\langle \Psi, \exp(\cdot\mu^1) b^1 \rangle = 0$

leads to $\langle \psi_{\alpha(i)}, \exp(\cdot \lambda_{\alpha(i)}) b^1 \rangle = 0$ which is not true except if $b^1 = 0$. Let $j \in \{1, 2, \dots, \bar{k} - 1\}$. If we assume that $b^i = 0$ for $i \in \{1, \dots, j\}$, then, in view of (3.32) and (3.34), we have

$$\begin{cases} \Delta(\mu^{j+1}) b^{j+1} = 0 \\ \langle \Psi, \exp(\cdot \mu^{j+1}) b^{j+1} \rangle = 0 \end{cases}$$

and in the same spirit as above, we can prove that $b^{j+1} = 0$. Summarizing, we have shown that $Ker(B_k) \cap Ker(C_k) = \{0\}$. Thus $Rank \left(\begin{bmatrix} B_k \\ C_k \end{bmatrix} \right) = n\bar{k}$ and consequently, by the use of elementary linear algebra tools, one can build a matrix D_k satisfying the lemma. This achieves the proof. ■

Remark 6 *In the same way as above, one can prove that the problem (3.35) can be written as*

$$\begin{cases} \frac{dX^k(\theta)}{d\theta} = A_k X^k(\theta) + F^k(\theta), \text{ for } \theta \in [-r, 0] \\ D_k X^k(0) = R^k \end{cases} \tag{3.39}$$

where D_k is the matrix given in the above lemma and R^k is a complex vector whose components are a mixing of those of the vectors E^k and N^k . In conclusion, the problem of computing terms of a local center manifold can be formulated in resolving a sequence of finite dimensional ODEs. This formulation makes the problem of computing coefficients of a local center manifold in suitable form easy to manipulate in symbolic or numerical computations.

3.2 Special cases.

3.2.1 Case of Hopf singularity. In this case, we suppose that $\Lambda = \{\pm \omega i\}$, where $\omega \neq 0$. By virtue of assumption **(H)**, it follows that $\dim P_\Lambda = 2$.

If we put

$$h_k(z) = \sum_{i=0}^k a_i^k z_1^{k-i} z_2^i \text{ and } X^k = col(a_0^k, \dots, a_k^k),$$

where the a_i^k are elements of Q_Λ , we prove that for $\theta \in [-r, 0]$, we have

$$\begin{cases} \frac{dX^k(\theta)}{d\theta} = A^{X^k(\theta)} + F^k(\theta), \text{ for } \theta \in [-r, 0] \\ B_k X^k(0) = E^k \text{ and } C_k X^k(0) = N^k. \end{cases} \tag{3.40}$$

where

$$A_k = \begin{bmatrix} -ki\omega \mathbf{I}_{\mathbb{R}^n} & 0 & 0 & \cdots & \cdots & 0 \\ 0 & -(k-2)i\omega \mathbf{I}_{\mathbb{R}^n} & 0 & \ddots & & \vdots \\ 0 & 0 & \ddots & \ddots & \ddots & \vdots \\ \vdots & \ddots & \ddots & \ddots & \ddots & 0 \\ \vdots & & \ddots & \ddots & (k-2)i\omega \mathbf{I}_{\mathbb{R}^n} & 0 \\ 0 & \cdots & \cdots & 0 & 0 & ki\omega \mathbf{I}_{\mathbb{R}^n} \end{bmatrix},$$

$$B_k = \text{Diag}(\Delta(-(k-2j))i\omega),, j \in \{0, \dots, k\}$$

and

$$C_k = \text{Diag}(\langle \Psi, \exp(-(k-2j))i\omega \rangle \mathbf{I}_{\mathbb{R}^n}),, j \in \{0, \dots, k\}.$$

3.2.2 The case of Bogdanov -Takens singularity.. In this case, we assume that zero is a double eigenvalue: $\Lambda = \{0, 0\}$, which ensures the existence of a center manifold associated with (2.1). By virtue of assumption **(H)**, it follows that $\dim P_\Lambda = 2$.

If we put

$$h_k(z) = \sum_{i=0}^k a_i^k z_1^{k-i} z_2^i \text{ and } X^k = \text{col} \left(a_0^k, \dots, a_k^k \right),$$

where the a_i^k are elements of Q_Λ , then for $\theta \in [-r, 0]$, we have

$$\begin{cases} \frac{dX^k(\theta)}{d\theta} = A_k X^k(\theta) + F^k(\theta), \text{ for } \theta \in [-r, 0] \\ B_k X^k(0) = E^k \text{ and } C_k X^k(0) = N^k. \end{cases}$$

where

$$A_k = \begin{bmatrix} 0 & 0 & 0 & \cdots & \cdots & 0 \\ k\mathbf{I}_{\mathbb{R}^n} & 0 & 0 & \ddots & & \vdots \\ 0 & (k-1)\mathbf{I}_{\mathbb{R}^n} & 0 & \ddots & \ddots & \vdots \\ \vdots & \ddots & \ddots & \ddots & \ddots & 0 \\ \vdots & & \ddots & \ddots & \ddots & 0 \\ 0 & \cdots & \cdots & 0 & \mathbf{I}_{\mathbb{R}^n} & 0 \end{bmatrix},$$

and B_k is a consequence of the following lemma:

Lemma 29 *The exponential matrix $\exp(\theta A_k)$ is given by*

$$\exp(\theta A_k) = \begin{bmatrix} C_0^k \mathbf{I}_{\mathbb{R}^n} & 0 & \cdots & \cdots & 0 \\ \theta C_1^k \mathbf{I}_{\mathbb{R}^n} & C_0^{k-1} \mathbf{I}_{\mathbb{R}^n} & \ddots & & \vdots \\ \vdots & \theta C_1^{k-1} & \ddots & \ddots & \vdots \\ \vdots & \vdots & & \ddots & 0 \\ \theta^k C_k^k \mathbf{I}_{\mathbb{R}^n} & \theta^{k-1} C_{k-1}^{k-1} \mathbf{I}_{\mathbb{R}^n} & \cdots & \cdots & C_0^0 \mathbf{I}_{\mathbb{R}^n} \end{bmatrix}$$

Proof : The matrix A_k is nilpotent. So, it is easy to verify that

$$\exp(\theta A_k) = \sum_{m=0}^k \frac{\theta^m (A_k)^m}{m!}.$$

In a recursive way, one can easily prove that $(A_k)^m = (\alpha_{ij} \mathbf{I}_{\mathbb{R}^n})_{1 \leq i, j \leq n(k+1)}$, where

$$\alpha_{ij} = \begin{cases} m! C_m^{k-j+1} & , \text{ if } i - j = k \\ 0 & , \text{ if } i - j \neq k. \end{cases}$$

which completes the proof of the lemma ■.

By using the above lemma, one can see that

$$B_k = \begin{bmatrix} C_0^k \Delta(0) & 0 & \cdots & \cdots & 0 \\ C_1^k \Delta^{(1)}(0) & C_0^{k-1} \Delta(0) & & & \vdots \\ \vdots & C_1^{k-1} \Delta^{(1)}(0) & \ddots & & \vdots \\ \vdots & \vdots & & \ddots & 0 \\ C_k^k \Delta^{(k)}(0) & C_{k-1}^{k-1} \Delta^{(k-1)}(0) & \cdots & \cdots & C_0^0 \Delta(0) \end{bmatrix}.$$

Example.

In this section we consider as an application of our computational scheme an example treated by Hale and Huang [56], where, in view of the study of qualitative structure of the flow on the center manifold, the authors need more precise information about a center manifold. In particular, they need to know its Taylor expansion up to the second order terms. It is a singularly perturbed delay equation given by

$$\varepsilon x'(t) = -x(t) + f(x(t-1), \lambda), \tag{3.41}$$

where ε is a real positive number assumed to be small, λ is a real parameter and f is an element of $C^k(\mathbb{R}, \mathbb{R})$, $k \geq 3$, more specifically

$$f(x, \lambda) = -(1 + \lambda)x + ax^2 + bx^3 + o(x^3), \text{ for some } a, b \in \mathbb{R}.$$

With the change of variables

$$w_1(t) = x(-\varepsilon rt) \text{ and } w_2(t) = x(-\varepsilon rt + 1 + \varepsilon r),$$

the equation (3.41) reads

$$\begin{cases} \frac{dw_1}{dt} = rw_1(t) - rf(w_2(t-1), \lambda) \\ \frac{dw_2}{dt} = rw_2(t) - rf(w_1(t-1), \lambda). \end{cases} \tag{3.42}$$

If $r = 1$ and $\lambda = 0$, then, the characteristic equation associated to (3.42) is

$$(\mu - 1)^2 - e^{-2\mu} = 0, \text{ for } \mu \in \mathbb{C}.$$

The above equation has zero as a double root and the remaining roots have a negative real part. This ensures the existence of a two dimensional center manifold associated to the equation (3.42) with $(r, \lambda) = (1, 0)$

Throughout this section we use the notation presented in section 2 for the equation (3.42) with $r = 1$ and $\lambda = 0$. Base of P_Λ and Q_Λ are respectively

$$\Phi = \begin{bmatrix} -1 & -\frac{1}{3} - \theta \\ 1 & \frac{1}{3} + \theta \end{bmatrix} \text{ and } \Psi = \begin{bmatrix} s & -s \\ -1 & 1 \end{bmatrix}, \text{ for } (\theta, s) \in [-1, 0] \times [0, 1].$$

It is easy to verify that $\langle \Psi, \Phi \rangle = \mathbf{I}_{\mathbb{R}^2}$, and

$$A\Phi = \Phi B, \text{ with } B = \begin{bmatrix} 0 & 1 \\ 0 & 0 \end{bmatrix}.$$

In view of the assumed smoothness on the function f , equation (3.42) has a local center manifold, at least of class C^3 , and

$$h(\xi) = a_0^2 \xi_1^2 + a_1^2 \xi_1 \xi_2 + a_2^2 \xi_2^2 + \chi(\xi), \text{ for some } a_i^2 \in Q_\Lambda \text{ and } \chi(\xi) = o(|\xi|^2).$$

Put $X^2 = col(a_0^2, a_1^2, a_2^2)$. We showed in subsection 3.2.1 that the computation of X^2 can be obtained by solving the differential equation

$$\begin{cases} \frac{dX^2(\theta)}{d\theta} = A_2 X^2(\theta) + F^2(\theta), \text{ for } \theta \in [-r, 0] \\ B_2 X^2(0) = E^2 \text{ and } C_2 X^2(0) = N^2, \end{cases} \tag{3.43}$$

where B_2 is the 6×6 real matrix given by

$$B_2 = \begin{bmatrix} -1 & -1 & 0 & 0 & 0 & 0 \\ -1 & -1 & 0 & 0 & 0 & 0 \\ 2 & 2 & -1 & -1 & 0 & 0 \\ 2 & 2 & -1 & -1 & 0 & 0 \\ 0 & -1 & 1 & 1 & -1 & -1 \\ -1 & 0 & 1 & 1 & -1 & -1 \end{bmatrix}.$$

Now, we will consider the computation of the parameters of the above system. According to relation (3.23) we have $\mathcal{F}^2(\xi)(\theta) = 0$, for $\theta \in [-1, 0]$. So, $F^2(\theta) = 0$, for $\theta \in [-1, 0]$ and as a consequence, we have $N^2 = -\langle \Psi, S^2 \rangle = 0$. Moreover, the relation (3.30) leads to $E^2 = \text{col} \left(-a, -a, \frac{4a}{3}, \frac{4a}{3}, \frac{-4a}{9}, \frac{-4a}{9} \right)$. On the other hand, by Lemma 29, it is easy to see that the 6×6 real matrix G_2 is given by

$$C_2 = \langle \Psi, \exp(\cdot A_2) \rangle = \begin{bmatrix} \frac{-1}{2} & \frac{1}{2} & 0 & 0 & 0 & 0 \\ 0 & 0 & 0 & 0 & 0 & 0 \\ \frac{1}{3} & \frac{-1}{3} & \frac{-1}{2} & \frac{1}{2} & 0 & 0 \\ -1 & 1 & 0 & 0 & 0 & 0 \\ \frac{-1}{12} & \frac{1}{12} & \frac{1}{6} & \frac{-1}{6} & \frac{-1}{2} & \frac{1}{2} \\ \frac{1}{3} & \frac{-1}{3} & \frac{-1}{2} & \frac{1}{2} & 0 & 0 \end{bmatrix}$$

then by replacing the first (resp, the third) line of B_2 by the first (resp, by the third) line of the matrix C_2 , the boundary condition $C_2 X^2(0) = N^2$ and $B_2 X^2(0) = E^2$ imply that $X^2(0)$ is given in the unique way by

$$X^2(0) = \text{col} \left(\frac{a}{2}, \frac{a}{2}, \frac{a}{3}, \frac{a}{3}, \frac{11a}{36}, \frac{11a}{36} \right)$$

and for $\theta \in [-1, 0]$, we have

$$a_0^2(\theta) = \frac{a}{2} \begin{bmatrix} 1 \\ 1 \end{bmatrix}, a_1^2(\theta) = a \left(\theta + \frac{1}{3} \right) \begin{bmatrix} 1 \\ 1 \end{bmatrix}, a_2^2(\theta) = a \left(\frac{\theta^2}{2} + \frac{\theta}{3} + \frac{11}{36} \right) \begin{bmatrix} 1 \\ 1 \end{bmatrix}.$$

This confirms the result established Hale and Huang in [56].

4. Computational scheme of Normal Forms

In this section, we present an algorithm for computing normal forms for FDEs. In the context of ODEs, the key idea is based on computing a change of variables that allows us to transform the original ODE into an equation with a simpler analytic expression. In this section, we

will be concerned with developing, in an algorithmic way, the notion of normal forms for FDEs of the form (2.1). Our approach is shared out in two shutters. In the first subsection, we assume that a local center manifold is known and we deal with developing, in conventional way, a computational scheme of normal form for the ODE (2.9) representing the restriction of the semi-flow generated by (2.1). In the second subsection, we deal with the equation (2.1) as an abstract infinite dimensional ODE of the form (2.8); our method consists in elaborating a scheme of computing nonlinear transformations that greatly simplify the (2.8), and we will show that this scheme leads us to simpler infinite dimensional ODE which coincides with the normal form of (2.1) (in the sense of definition presented in [44]).

4.1 Normal form construction of the reduced system

Let h be a mapping from R^m into Q_Λ whose graph is a local center manifold associated with the equation (2.1). In the previous section, we have elaborated an algorithmic procedure allowing us to compute at any order k the terms of the Taylor expansion of h . Note that, in general, it is the most information that can be extracted from h with the impossibility of obtaining the closed form. Without loss of generality h may be assumed in the form

$$h = \sum_{i \geq 2} h_i.$$

The flow of the FDE (2.1), on this local center manifold is described by the following m -dimensional ODE

$$\dot{x} = Bx + G(x), \quad (4.44)$$

where $G(x) = \Psi(0)H(x)$. If we assume that $(h_i)_{i \geq 2}$ are already computed, then terms of the ODE (4.44) are known at any order. In other words, if $G = \sum_{i \geq 2} G_i$ then G_i is known for all $i \geq 2$ once $(h_i)_{i \geq 2}$ are founded.

Consider a nonlinear transformation of the form

$$x = \bar{x} + V(\bar{x}) \quad (4.45)$$

where V be a mapping from R^m into R^m such that $V(0) = 0$, $DV(0) = 0$. Assume that the effects of the above change of variables on the reduced system (4.46) is of the form

$$\dot{\bar{x}} = B\bar{x} + F(\bar{x}). \quad (4.46)$$

Our main goal now is to develop an algorithmic scheme providing us with adequate nonlinear transformations V that transform (2.6) into a simpler equation (4.46) (ie. the nonlinearity F is simpler than H). Without loss of generality, we put

$$V = \sum_{i \geq 2} V_i \text{ and } F = \sum_{i \geq 2} F_i.$$

In the sequel, we will deal with developing a the recursive efficient approach for computing the k th order normal form F_k and the k th order nonlinear transformation V_k in terms of $(G_i)_{2 \leq i \leq k}$ as well as the terms $(F_i)_{2 \leq i \leq k-1}$ already computed. We start by the following Definition:

Definition 35 Let $j \geq 2$. We denote by M_j^1 the operator defined by

$$(M_j^1 p)(x) = Dp(x) Bx - Bp(x),$$

for all $p \in V_j^m(R^m)$.

The operators M_j^1 , defined above, are exactly the Lie brackets that appear in computing normal forms for finite dimensional ODEs. It is well known that the space $V_j^m(R^m)$ may be decomposed as

$$V_j^m(R^m) = Im(M_j^1) \oplus Im(M_j^1)^c \tag{4.47}$$

where the complementary space $Im(M_j^1)^c$ is not uniquely determined. Let P^j be the projection associated with the above decomposition. If we choose bases for $Im(M_j^1)$ and $Im(M_j^1)^c$, then, each element q of $V_j^m(R^m)$ can be split into two parts $P^j q$ and $(I - P^j) q$: $P^j q$ can be spanned by the basis of $Im(M_j^1)$ and $(I - P^j) q$ by that of $Im(M_k^1)^c$.

Theorem 4 Fix $k \geq 2$. Then, the recursive formula for computing the coefficients of the normal form associated to the decomposition (4.47) is given by

$$\begin{aligned} F_k(\bar{x}) &= G_k(\bar{x}) - (M_k^1 V_k)(\bar{x}) \\ &+ \sum_{i=2}^{k-1} \{DG_{k+1-i}(\bar{x}) V_i(\bar{x}) - DV_i(\bar{x}) F_{k+1-i}(\bar{x})\} \\ &+ \sum_{j=2}^{\lfloor \frac{k}{2} \rfloor} \frac{1}{j!} \sum_{i=j}^{k-j} D^j G_i(\bar{x}) \left\{ \sum_{l_1+l_2+\dots+l_j=k-(i-j)} V_{l_1} V_{l_2} \dots V_{l_j} \right\}(\bar{x}). \end{aligned} \tag{4.48}$$

Proof. Substituting the change of variables (4.45) into (4.44) results in

$$Bx + \sum_{k \geq 2} G_k(x) = [I + DV(\bar{x})] \left[B\bar{x} + \sum_{k \geq 2} F_k(\bar{x}) \right],$$

which can be rearranged as

$$\sum_{k \geq 2} F_k(\bar{x}) = \sum_{k \geq 2} G_k(\bar{x} + V(\bar{x})) + \sum_{k \geq 2} BV_k(\bar{x}) - \sum_{k \geq 2} DV_k(\bar{x})B\bar{x} - \left[\sum_{k \geq 2} DV_k(\bar{x}) \right] \left[\sum_{k \geq 2} F_k(\bar{x}) \right]$$

Then we use Taylor expansion of $G_k(\bar{x} + V(\bar{x}))$ near $V = 0$ to rewrite the above equation as

$$\begin{aligned} \sum_{k \geq 2} F_k(\bar{x}) &= \sum_{k \geq 2} G_k(\bar{x}) + \sum_{k \geq 2} DG_k(\bar{x}) \left(\sum_{j \geq 2} V_j(\bar{x}) \right) \\ &+ \sum_{k \geq 2} (M_k^1 V_k)(\bar{x}) - \left[\sum_{k \geq 2} DV_k(\bar{x}) \right] \left[\sum_{k \geq 2} F_k(\bar{x}) \right] \\ &+ \sum_{k \geq 2} \left(\sum_{j \geq 2} \frac{1}{j!} D^j G_k(\bar{x}) \left(\sum_{l \geq 2} V_l(\bar{x}) \right)^j \right). \end{aligned}$$

Finally comparing terms degree k in the above equation yields the formula (4.48). This achieves the proof of the Theorem. ■

The formula (3.23) given in the above theorem can be rewritten in a compact form

$$F_k = \tilde{G}_k - M_j^1 V_k, \tag{4.49}$$

where

$$\begin{aligned} \tilde{G}_k(\bar{x}) &= G_k(\bar{x}) + \sum_{i=2}^{k-1} \{ DG_{k+1-i}(\bar{x}) V_i(\bar{x}) - DV_i(\bar{x}) F_{k+1-i}(\bar{x}) \} \\ &+ \sum_{j=2}^k \frac{1}{j!} \sum_{i=j}^{k+j} D^j G_i(\bar{x}) \left\{ \sum_{l_1+l_2+\dots+l_j=k-(i-j)} V_{l_1} V_{l_2} \dots V_{l_j} \right\}(\bar{x}) \end{aligned}$$

Then, by virtue of (4.49) and (4.47), one can compute an adequate nonlinear transformation V_k such that

$$M_k^1 V_k = P^k \tilde{G}_k, \tag{4.50}$$

and which leads us to

$$F_k = (I - P^k) \tilde{G}_k. \tag{4.51}$$

In other words, we can find a change of variables that affect the reduced system by taking away nonlinear terms (called non resonant terms) that are in the range subspaces $Im(M_k^1)$ and conserving only terms (called resonant terms) that are in the complementary subspace $Im(M_k^1)^c$.

Remark 7 *It has been observed that the subspace $Im(M_k^1)^c$ is not uniquely determined. Moreover, according to the equations (4.50) and (4.51), one can note that the nonlinear transformation V_k depends on the choice of $Im(M_k^1)^c$. Consequently the normal forms are not unique. In applications, we choose a suitable complementary space to the situation to be handled.*

Remark 8 *In view of the above Theorem, it is noted that the k th order term F_k of the normal form depends upon the known of $(F_j)_{2 \leq j \leq k-1}$ and the results $(V_j)_{2 \leq j \leq k}$ as well as $(G_j)_{2 \leq j \leq k-1}$. However, it has observed from the Proposition (34) that the homogeneous polynomial G_j can be given in terms of $(h_i)_{2 \leq i \leq j-1}$. Hence, in order to present the complete scheme for computing normal forms for (2.6), we must take into account the algorithm developed in section 3 and which provides us with homogeneous parts of the mapping h . As a consequence, the complete scheme for computing normal forms for (2.6) should be a combination of the formulae (3.21), (3.39) and (3.23).*

In order to save computational time and computer memory, the following Theorem illustrates another approach that combines center manifold and normal forms schemes into one step to simultaneously obtain a compact form illustrating the close relationship between the normal forms F , the associated nonlinear transformations V , a local center manifold h and the coefficients of the original FDE (2.1).

Theorem 5 *Effect the reduced system (2.9) with a nonlinear transformation of the form (4.45). So, if \bar{x} is a solution of the equation (2.1) then F and V satisfy*

$$DV(\bar{x})B\bar{x} - BV(\bar{x}) = \Psi(0) f\left(\Phi[\bar{x} + V(\bar{x})] + \tilde{h}(\bar{x})\right) - DV(\bar{x})F(\bar{x}) - F(\bar{x}) \tag{4.52}$$

and

$$D\tilde{h}(\bar{x})B - \tilde{A}_1\tilde{h}(\bar{x}) = (I - \pi)X_0f\left(\Phi[\bar{x} + V(\bar{x})] + \tilde{h}(\bar{x})\right) - D\tilde{h}(\bar{x})F(\bar{x}), \tag{4.53}$$

where $\tilde{h}(\bar{x}) = h(\bar{x} + V(\bar{x}))$.

Proof. Substituting the nonlinear transformation (4.45) into (2.6) results in

$$[I + DV(\bar{x})]\dot{\bar{x}} = B\bar{x} + BV(\bar{x}) + \tilde{f}_1(\bar{x}),$$

where $\tilde{f}_1(\bar{x}) = \Psi(0) f\left(\Phi[\bar{x} + V(\bar{x})] + \tilde{h}(\bar{x})\right)$. So, in view of (FN1) it follows that

$$[I + DV(\bar{x})][B\bar{x} + F(\bar{x})] = B\bar{x} + BV(\bar{x}) + \tilde{f}_1(\bar{x}),$$

which can be rearranged as

$$DV(\bar{x})B\bar{x} - BV(\bar{x}) = \tilde{f}_1(\bar{x}) - DV(\bar{x})F(\bar{x}) - F(\bar{x}).$$

This gives the relation (4.52). To prove (4.53), we need the following lemma: ■

Lemma 30 *Let h be a map from \mathbb{R}^m into Q_Λ with $h(0) = 0$ and $Dh(0) = 0$. A necessary and sufficient conditions on the graph of h to be a local center manifold of equation (2.1) is that there exists a neighborhood V of zero in \mathbb{R}^m such that*

$$Dh(z)Bz - \tilde{A}_1h(z) = (I - \pi)X_0f(\Phi z + h(z)) - Dh(z)\Psi(0)f(\Phi z + h(z))$$

(4.54)

for $z \in V$

Proof. Substituting the nonlinear transformation (4.45) into the equation (4.54) satisfied by h results in

$$Dh(\bar{x} + V(\bar{x})) \left[B\bar{x} + BV(\bar{x}) + \tilde{f}_1(\bar{x}) \right] - \tilde{A}_1h(\bar{x} + V(\bar{x})) = \tilde{f}_2(\bar{x})$$

with $\tilde{f}_2(\bar{x}) = (I - \pi)X_0f(\Phi[\bar{x} + V(\bar{x})] + \tilde{h}(\bar{x}))$. So, by the aid of the formula (4.52) already proved, the above equation reads

$$Dh(\bar{x} + V(\bar{x})) [I + DV(\bar{x})] [B\bar{x} + F(\bar{x})] - \tilde{A}_1h(\bar{x} + V(\bar{x})) = \tilde{f}_2(\bar{x}),$$

which is equivalent to

$$D\tilde{h}(\bar{x})B - \tilde{A}_1\tilde{h}(\bar{x}) = \tilde{f}_2(\bar{x}) - D\tilde{h}(\bar{x})F(\bar{x}).$$

This achieves the proof of the theorem. ■

In general, the closed form solutions of (4.53) cannot be founded. Thus, approximate solutions may be assumed in the form of

$$\tilde{h} = \sum_{i \geq 2} \tilde{h}_i$$

where \tilde{h}_i is an element of $V_i^m(Q_\Lambda^1)$. If we denote by M_j^2 the operators defined as

$$(M_j^2p)(x) = Dp(x)Bx - \tilde{A}_1p(x) \quad \text{for all } p \in V_j^m(Q_\Lambda^1),$$

then, comparing the same order in the equations (4.52) and (4.53) in the above theorem results in

$$F_k(\bar{x}) = H_k^1(\bar{x}) - (M_k^1V_k)(\bar{x}) \tag{4.55}$$

and

$$(M_k^2\tilde{h}_k)(\bar{x}) = H_k^2(\bar{x}) \tag{4.56}$$

where $H_k^1(\bar{x})$ and $H_k^2(\bar{x})$ are homogeneous polynomial of degree k . More exactly, $H_k^1(\bar{x})$ and $H_k^2(\bar{x})$ are respectively the k th homogenous part of the functions

$$H^1(x) = f^1(\Phi[\bar{x} + V(\bar{x})] + \tilde{h}(\bar{x})) - DV(\bar{x})F(\bar{x}) \tag{4.57}$$

and

$$H^2(\bar{x}) = f^2\left(\Phi[\bar{x} + V(\bar{x})] + \tilde{h}(\bar{x})\right) - D\tilde{h}(\bar{x})F(\bar{x}), \tag{4.58}$$

where $f^1(\phi) = \Psi(0)f(\phi)$ and $f^2(\phi) = (I - \pi)X_0f(\phi)$, for all $\phi \in C$. It is easy to see that $H_k^1 = \tilde{H}_k$ for all $k \geq 2$. An exact formula of $H_k^1(\bar{x})$ and $H_k^2(\bar{x})$ is given in the following result.

Theorem 6 *The recursive formula deriving $H_k^1(\bar{x})$ and $H_k^2(\bar{x})$ is given by*

$$\begin{aligned} H_k^1(\bar{x}) &= f_k^1(\Phi\bar{x}) + \sum_{i=2}^{k-1} \left\{ Df_{k+1-i}^1(\Phi\bar{x})W_i(\bar{x}) - DV_i(\bar{x})F_{k+1-i}(\bar{x}) \right\} \\ &\quad + \sum_{j=2}^{\lfloor \frac{k}{2} \rfloor} \frac{1}{j!} \sum_{i=j}^{k-j} D^j f_i^1(\Phi\bar{x}) \left\{ \sum_{l_1+l_2+\dots+l_j=k-(i-j)} W_{l_1}W_{l_2}\dots W_{l_j} \right\}(\bar{x}) \end{aligned}$$

and

$$\begin{aligned} H_k^2(\bar{x}) &= f_k^2(\Phi\bar{x}) + \sum_{i=2}^{k-1} \left\{ Df_{k+1-i}^2(\Phi\bar{x})W_i(\bar{x}) + D\tilde{h}_i(\bar{x})F_{k+1-i}(\bar{x}) \right\} \\ &\quad + \sum_{j=2}^{\lfloor \frac{k}{2} \rfloor} \frac{1}{j!} \sum_{i=j}^{k-j} D^j f_i^2(\Phi\bar{x}) \left\{ \sum_{l_1+l_2+\dots+l_j=k-(i-j)} W_{l_1}W_{l_2}\dots W_{l_j} \right\}(\bar{x}), \end{aligned}$$

where $W_l = \Phi V_l + \tilde{h}_l$ for all $l \geq 2$.

Proof. In the same spirit of the the proof of the theorem (), one can easily obtain the above relations. ■

The above result illustrates clearly how the elements $H_k^1(x)$ and $H_k^2(x)$ depend into the terms $(V_i)_{2 \leq i \leq k-1}$ and $(\tilde{h}_i)_{2 \leq i \leq k-1}$. So if we assume that the lower order terms in V and \tilde{h} are already computed, then, in order to compute an adequate nonlinear transformation V_k that greatly simplifies the reduced system, we proceed in the following way: We consider the equation (4.55), then, by the aid of a decomposition of the form (4.47) of the space $V_j^m(R^m)$, the homogeneous polynomial $H_k^1(x)$ is spliced into two parts the resonant and the non resonant one. Removing non resonant terms and letting resonant terms results in

$$M_k^1 V_k = P^k H_k^1 \quad \text{and} \quad F_k = (I - P^k) H_k^1.$$

Remark 9 One can ask a question about the usefulness of the second equation (4.56) of the scheme. In fact, once H_k^1 is known, the equation (4.56) will be needed for computing the k th order term \tilde{h}_k which allows us to pass to the next step $k + 1$ where the computation of the $(k + 1)$ th order normal form F_{k+1} and the $(k + 1)$ th order nonlinear transformation as well as \tilde{h}_{k+1} . In conclusion, solving equation (4.56) is necessary for passing from a step to step.

Let us now consider the equation (4.56). In view of the definition of \tilde{h} and the formula (4.57) one can easily observe that \tilde{h}_k and H_k^2 are respectively elements of $V_k^m(Q_\Lambda^1)$ and $V_k^m(Ker(\pi))$. So, according to the notation presented in section 3, polynomials \tilde{h}_k and H_k^2 are written as

$$\tilde{h}_k(\bar{x}) = \sum_{i=1}^{\bar{k}} b_i^k \bar{x}^{q_i} \quad \text{and} \quad H_k^2(\bar{x}) = \sum_{i=1}^{\bar{k}} c_i^k \bar{x}^{q_i} + X_0 \sum_{i=1}^{\bar{k}} \alpha_i^k \bar{x}^{q_i},$$

where the coefficients $(b_i^k)_{1 \leq i \leq \bar{k}}$, $(c_i^k)_{1 \leq i \leq \bar{k}}$ and $(\alpha_i^k)_{1 \leq i \leq \bar{k}}$ are respectively elements of Q_Λ^1 , $Ker(\pi)$ and R^n . It is noted that, from the fact that $H_k^2 \in V_k^m(Ker(\pi))$, the coefficients c_i^k and α_i^k should satisfy the relation $c_i^k = \Phi\Psi(0)\alpha_i^k$ for $i = 1, \dots, \bar{k}$. Put $\tilde{X}^k = col(b_1^k, b_2^k, \dots, b_{\bar{k}}^k)$ and $\tilde{F}^k = col(c_1^k, c_2^k, \dots, c_{\bar{k}}^k)$. Identifying the two sides of the equation (4.56) according the canonical basis $\{\bar{x}^{q_i} : i = 1, \dots, \bar{k}\}$ leads us to

$$\left\{ \begin{array}{l} \frac{d\tilde{X}^k(\theta)}{d\theta} = A_k \tilde{X}^k(\theta) + \tilde{F}^k(\theta), \text{ for } \theta \in [-r, 0] \\ \frac{d\tilde{X}^k(0)}{d\theta} - L(\tilde{X}^k) = \tilde{M}^k \quad \tilde{X}^k \in (Q_\Lambda)^{\bar{k}} \end{array} \right.$$

where $\tilde{M}^k = col(\alpha_1^k, \alpha_2^k, \dots, \alpha_{\bar{k}}^k)$. Then, if we combine the adjoint bilinear form (cf. section 2) and the variation of constant formula tools, The above problem reads

$$\left\{ \begin{array}{l} \frac{d\tilde{X}^k(\theta)}{d\theta} = A_k \tilde{X}^k(\theta) + \tilde{F}^k(\theta), \text{ for } \theta \in [-r, 0] \\ B_k \tilde{X}^k(0) = \tilde{E}^k \quad \text{and} \quad C_k \tilde{X}^k(0) = \tilde{N}^k \end{array} \right.$$

where

$$\tilde{N}^k = - \langle \Psi, \tilde{S}^k \rangle \tag{4.59}$$

and

$$\tilde{E}^k = \tilde{M}^k - \tilde{F}^k(0) - L\tilde{S}^k \tag{4.60}$$

with

$$\tilde{S}^k = \int_0^\theta \exp((\theta - s) A_k) F^k(s) ds$$

Finally, we have the following result which provides us with the algorithm of computing coefficients $(b_i^k)_{1 \leq i \leq \bar{k}}$ in terms of $(c_i^k)_{1 \leq i \leq \bar{k}}$ and $(\alpha_i^k)_{1 \leq i \leq \bar{k}}$.

Proposition 35 *Let A_k and D_k be the matrices appearing in the algorithm of approximation of a local center manifold (cf. section 3). The equation (3.38) is equivalent to*

$$\begin{cases} \frac{d\tilde{X}^k(\theta)}{d\theta} = A_k \tilde{X}^k(\theta) + \tilde{F}^k(\theta), \text{ for } \theta \in [-r, 0] \\ D_k \tilde{X}^k(0) = \tilde{R}^k \end{cases} \tag{4.61}$$

where \tilde{R}^k is a vector whose components are a mixing of the ones of the vectors \tilde{E}^k and \tilde{N}^k respectively defined in (4.60) and (4.59).

In conclusion, we claim that the sequence of equations (4.55) and (4.61) is all what we need for computing normal forms for the reduced system (2.6) at any order.

Remark 10 *In the work [44], the authors have been concerned with solving, at each step, equations similar to (4.55) and (4.56). In view of the difficulties entailed by the operator \tilde{A}^1 in the definition of M_j^2 ($j \geq 2$), the authors in [44] have been restricted to the study of the spectrum of \tilde{A}^1 . And under non resonance conditions, the authors in [44] proved that M_j^2 is nonsingular for all $j \geq 2$. However, their derivation does not allow them to compute or at least approximate the inverse of M_j^2 . In contrast, the previous result provides us with a suitable form of (4.56) which lends itself to numerical or symbolic computations by means of a recursive process.*

4.2 Normal form construction for FDEs

In this subsection, we will be concerned with equation (2.1), for which an algorithmic scheme for computing normal forms is derived. In view of the preliminary section, it is known that equation (2.1) can be viewed as an infinite dimensional ODE given by

$$\begin{cases} \dot{x} = Bx + \tilde{f}^1(x, y) \\ \dot{y} = \tilde{A}_1 y + \tilde{f}^2(x, y) \end{cases} \tag{4.62}$$

where $\bar{f}^1(x, y) = \Psi(0) f(\Phi x + y)$ and $\bar{f}^2(x, y) = (I - \pi) X_0 f(\Phi x + y)$. Effecting the equation (4.62) with nonlinear transformations of the form

$$\begin{cases} x &= \bar{x} + V^1(\bar{x}) \\ y &= \bar{y} + V^2(\bar{x}) \end{cases} \tag{4.63}$$

results in

$$\begin{cases} \dot{\bar{x}} &= B\bar{x} + g^1(\bar{x}, \bar{y}) \\ \dot{\bar{y}} &= \tilde{A}_1\bar{y} + g^2(\bar{x}, \bar{y}) \end{cases} \tag{4.64}$$

Our goal in the sequel is to develop an iterative procedure for finding adequate transformations V^1 and V^2 that greatly simplify equation (4.62). As has been defined in [44], the transformed equation (4.64) associated to that change of variables is called normal form of (2.1). We first start by stating the following Theorem that illustrates us how, the above change of variables (4.63), affects equation (4.62).

Theorem 7 *Effecting the equation (4.62) with the change of variables (4.45) results in equation of the form(4.64) with g^1 and g^2 satisfying*

$$g^1(\bar{x}, \bar{y}) = \bar{f}^1(\bar{x} + V^1(\bar{x}), \bar{y} + V^2(\bar{x})) - DV^1(\bar{x})g^1(\bar{x}, \bar{y}) - [DV^1(\bar{x})B\bar{x} - BV^1(\bar{x})] \tag{4.65}$$

and

$$g^2(\bar{x}, \bar{y}) = \bar{f}^2(\bar{x} + V^1(\bar{x}), \bar{y} + V^2(\bar{x})) - DV^2(\bar{x})g^1(\bar{x}, \bar{y}) - [DV^2(\bar{x})B\bar{x} - \tilde{A}_1V^2(\bar{x})] \tag{4.66}$$

Proof. First, differentiating the relations of (4.63) results in

$$\begin{cases} \dot{x} &= [I + DV^1(\bar{x})] \dot{\bar{x}} \\ \dot{y} &= \dot{\bar{y}} + DV^2(\bar{x}) \dot{\bar{x}} \end{cases}$$

So, assuming that the change of variables (4.45) transforms equation (4.62) into equation of the form (FN2) yields

$$\begin{cases} \dot{x} &= [I + DV^1(\bar{x})] [B\bar{x} + g^1(\bar{x}, \bar{y})] \\ \dot{y} &= [\tilde{A}_1\bar{y} + g^2(\bar{x}, \bar{y})] + DV^2(\bar{x}) [B\bar{x} + g^1(\bar{x}, \bar{y})] \end{cases}$$

Finally combining the above formula with (4.62) and (4.63) yields equations (4.65) and (4.66). This ends the proof of the Theorem. ■

A conventional approach for computing normal forms consists in finding adequate nonlinear transformations V^1 and V^2 that provide us, by substituting them into equation (4.62), with a simpler form of the both

of g^1 and g^2 . In general, however, the closed form of V^1 and V^2 respectively solutions of (4.65) and (4.66) cannot be founded. Thus, approximate solutions may be assumed in the form of

$$V^1 = \sum_{i \geq 2} V_i^1 \text{ and } V^2 = \sum_{i \geq 2} V_i^2.$$

Our task is then reduced only to the computation terms of the Taylor expansion respectively of V^1 and V^2 . Denote by $\tilde{f}^1(\bar{x}, \bar{y})$ and $\tilde{f}^2(\bar{x}, \bar{y})$ respectively the function $\tilde{f}^1(\bar{x} + V^1(\bar{x}), \bar{y} + V^2(\bar{x}))$ and $\tilde{f}^2(\bar{x} + V^1(\bar{x}), \bar{y} + V^2(\bar{x}))$. So, expanding and comparing the both sides of equations (4.65) and (4.66) results in

$$g_k^1(\bar{x}, \bar{y}) = \tilde{f}_k^1(\bar{x}, \bar{y}) - (M_k^1 V_k^1)(\bar{x}) \tag{4.67}$$

and

$$g_k^2(\bar{x}, \bar{y}) = \tilde{f}_k^2(\bar{x}, \bar{y}) - (M_k^2 V^2)(\bar{x}) \tag{4.68}$$

where $\tilde{f}_k^1(\bar{x}, \bar{y})$ and $\tilde{f}_k^2(\bar{x}, \bar{y})$ are respectively the k th order term (with respect to the arguments \bar{x} and \bar{y}) of the functions $\tilde{f}^1(\bar{x}, \bar{y}) = \tilde{f}^1(\bar{x}, \bar{y}) - DV^1(\bar{x})g^1(\bar{x}, \bar{y})$ and $\tilde{f}^2(\bar{x}, \bar{y}) = \tilde{f}^2(\bar{x}, \bar{y}) - DV^2(\bar{x})g^1(\bar{x}, \bar{y})$. More precisely, we have the following proposition:

Theorem 8 *The recursive expression of $\tilde{f}_k^1(\bar{x}, \bar{y})$ and $\tilde{f}_k^2(\bar{x}, \bar{y})$ is given by*

$$\begin{aligned} \tilde{f}_k^1(\bar{x}, \bar{y}) = & f_k^1(\Phi\bar{x} + \bar{y}) + \sum_{i=2}^{k-1} \left\{ Df_i^1(\Phi\bar{x} + \bar{y}) W_{k+1-i}(\bar{x}) + DV_i^1(\bar{x}) g_{k+1-i}^1(\bar{x}, \bar{y}) \right\} \\ & + \sum_{j=2}^{\lfloor \frac{k}{2} \rfloor} \frac{1}{j!} \sum_{i=j}^{k-j} D^j f_i^1(\Phi\bar{x} + \bar{y}) \left\{ \sum_{l_1+l_2+\dots+l_j=k-(i-j)} W_{l_1} W_{l_2} \dots W_{l_j} \right\}(\bar{x}) \end{aligned} \tag{4.69}$$

and

$$\begin{aligned} \tilde{f}_k^2(\bar{x}, \bar{y}) = & f_k^2(\Phi\bar{x} + \bar{y}) + \sum_{i=2}^{k-1} \left\{ Df_i^2(\Phi\bar{x} + \bar{y}) W_{k+1-i}(\bar{x}) + DV_i^1(\bar{x}) g_{k+1-i}^1(\bar{x}, \bar{y}) \right\} \\ & + \sum_{j=2}^{\lfloor \frac{k}{2} \rfloor} \frac{1}{j!} \sum_{i=j}^{k-j} D^j f_i^2(\Phi\bar{x} + \bar{y}) \left\{ \sum_{l_1+l_2+\dots+l_j=k-(i-j)} W_{l_1} W_{l_2} \dots W_{l_j} \right\}(\bar{x}) \end{aligned} \tag{4.70}$$

where $W_l(\bar{x})$ is the homogeneous part of degree l of $W(\bar{x}) = \Phi V^1(\bar{x}) + V^2(\bar{x})$.

Fix $y = 0$ in formulae (4.67) and (4.68). Refereing to the results stated in the previous subsection, one can find adequate nonlinear transforma-

tions V_k^1 and V_k^2 satisfying

$$(M_k^1 V_k^1)(\bar{x}) = P^k \tilde{f}_k^1(\bar{x}, 0) \tag{4.71}$$

$$g_k^1(\bar{x}, 0) = (I - P^k) \tilde{f}_k^1(\bar{x}, 0) \tag{4.72}$$

and

$$(M_k^2 V_k^2)(\bar{x}) = \tilde{f}_k^2(\bar{x}, 0). \tag{4.73}$$

And thus $g_k^2(\bar{x}, 0) = 0$. To be explicit, we state the following definition, similar to the one given in [44], of normal forms for (2.1):

Definition 36 *The normal form for (2.1) (or equation (2.7)) relative to the decomposition (4.47) is an equation of the form*

$$\begin{cases} \dot{\bar{x}} &= B\bar{x} + \sum_{k \geq 2} g_k^1(\bar{x}, \bar{y}) \\ \dot{\bar{y}} &= \tilde{A}_1 \bar{y} + \sum_{k \geq 2} g_k^2(\bar{x}, \bar{y}) \end{cases}$$

with g_k^1 and g_k^2 satisfying (4.71), (4.72) and (4.73) for all $k \geq 2$.

Now, with the aid of the previous Definition, we are in position to state the following Theorem summarizing the results for the new recursive and computationally efficient approach, providing us with terms of the normal form for FDEs at any order and the associated nonlinear transformations:

Theorem 9 *Consider an FDE of the form (2.1) with non hyperbolic steady state satisfying the hypothesis **(H)**. If we consider (2.1) as an infinite dimensional ODE of the form (2.8), then there exists formal nonlinear transformations $x = \bar{x} + V^1(\bar{x})$ and $y = \bar{y} + V^2(\bar{y})$ such that*

$$\begin{cases} \dot{\bar{x}} &= B\bar{x} + \sum_{k \geq 2} g_k^1(\bar{x}, \bar{y}) \\ \dot{\bar{y}} &= \tilde{A}_1 \bar{y} + \sum_{k \geq 2} g_k^2(\bar{x}, \bar{y}) \end{cases} \tag{4.74}$$

with g_k^1 and g_k^2 satisfying (4.71), (4.65), (4.73) and $g_k^2(\bar{x}, 0) = 0$ for \bar{x}, \bar{y} small and $k \geq 2$. Moreover, a local center manifold satisfies $\bar{y} = 0$ and the normal form (in the usual sense for ODEs) of the reduced system of (2.1) on this invariant manifold is given by the m -dimensional ODE

$$\dot{\bar{x}} = B\bar{x} + g^1(\bar{x}, 0). \tag{4.75}$$

Proof: After what was done before the statement, one can see that the first part of the Theorem is a direct consequence of properties of the operators M_k^1 and M_k^2 stated in the previous subsection combined with the equations (4.71), (4.65), (4.73). Let us to prove the second part of the Theorem. This will be done in two steps: First, substituting $\bar{y} = 0$ into (4.69) results in

$$\begin{aligned} \tilde{f}_k^1(\bar{x}, 0) &= f_k^1(\Phi\bar{x}) + \sum_{i=2}^{k-1} \{ Df_i^1(\Phi\bar{x}) W_{k+1-i}(\bar{x}) + DV_i^1(\bar{x}) g_{k+1-i}^1(\bar{x}) \} \\ &+ \sum_{j=2}^{\lfloor \frac{k}{2} \rfloor} \frac{1}{j!} \sum_{i=j}^{k-j} D^j f_i^1(\Phi\bar{x}) \left\{ \sum_{l_1+l_2+\dots+l_j=k-(i-j)} W_{l_1} W_{l_2} \dots W_{l_j} \right\}(\bar{x}). \end{aligned}$$

So, if we observe that

$$H_i^1(\bar{x}) = \Psi(0) f_i(\Phi\bar{x}) \quad \text{for } i \geq 2$$

then, it follows that

$$g_k^1(\bar{x}, 0) = F_k(\bar{x}).$$

As a consequence, the equation (4.75) is exactly the normal form of the reduced system of (2.1) in the local center manifold considered. In the second step, we need to show that $\bar{y} = 0$ provides us with this center manifold. To this end we need the following lemma:

Lemma 31 *The equation $\bar{y} = 0$ yields the equation of a local invariant center manifold of (2.1).*

Proof: Substituting $\bar{y} = 0$ in the change of variables (4.63) yields

$$\begin{cases} x &= \bar{x} + V^1(\bar{x}) \\ y &= V^2(\bar{x}). \end{cases} \tag{4.76}$$

So, by applying the implicit functions Theorem to the above equation, one can prove the existence of a function h mapping a neighborhood V of zero in R^m into $Ker(\pi)$ such that $y = l(x)$. This implies that

$$V^2(\bar{x}) = \tilde{l}(\bar{x}) = l(\bar{x} + V^1(\bar{x})). \tag{4.77}$$

In the other hand, it is known that $V^2(\bar{x})$ is a solution of (4.66). This reads

$$\left[DV^2(\bar{x}) B\bar{x} - \tilde{A}_1 V^2(\bar{x}) \right] = \bar{f}^2(\bar{x} + V^1(\bar{x}), V^2(\bar{x})) - DV^2(\bar{x}) F(\bar{x}).$$

So, by virtue of (4.77), the above equation can be written as

$$\left[D\tilde{l}(\bar{x}) B\bar{x} - \left(\tilde{A}_1 \tilde{l} \right) (\bar{x}) \right] = G(\bar{x}), \tag{4.78}$$

where $G(\bar{x}) = (I - \pi) X_0 \bar{f} \left(\Phi(\bar{x} + V^1(\bar{x}), \tilde{l}(\bar{x})) - D\tilde{l}(\bar{x}) F(\bar{x}) \right)$. To achieve the proof of the Lemma, we should prove that the k th parts $\tilde{l}_k(\bar{x})$ and $\tilde{h}_k(\bar{x})$ respectively of $\tilde{l}(\bar{x})$ and $\tilde{h}(\bar{x})$ coincide for all $k \geq 2$. This will be done in a recursive way: In one hand, for $k = 2$, it is noted that $\tilde{l}_2(\bar{x})$ and $\tilde{h}_2(\bar{x})$ are respectively solutions of $(M_2^2 \tilde{h}_2)(\bar{x}) = (I - \pi) X_0 f_2(\bar{x})$ and $(M_2^2 \tilde{l}_2)(\bar{x}) = (I - \pi) X_0 f_2(\bar{x})$, and since the operator is nonsingular then it follows that $\tilde{l}_2(\bar{x}) = \tilde{h}_2(\bar{x})$. In the other hand, Assuming that $\tilde{l}_i(\bar{x}) = \tilde{h}_i(\bar{x})$ for $2 \leq i \leq k - 1$ results in

$$H_k^2(\bar{x}) = G_k(\bar{x}),$$

where $G_k(\bar{x})$ is the homogeneous part of degree k of the function $G(\bar{x})$ defined above. Thus, combining (4.78) and (4.56) leads to $\tilde{l}_k(\bar{x}) = \tilde{h}_k(\bar{x})$. This ends the proof of the Theorem.

Chapter 7

NORMAL FORMS AND BIFURCATIONS FOR DELAY DIFFERENTIAL EQUATIONS

T. Faria

*Departamento de Matemática,
Faculdade de Ciências, and CMAF,
Universidade de Lisboa
Campo Grande 1749-016 Lisboa
Portugal
tfaria@ptmat.fc.ul.pt*

1. Introduction

The key idea of the normal form (n.f.) technique is to transform a nonlinear differential equation into an equation with a simpler analytic expression, called a *normal form*, which has the same qualitative behaviour of the original equation. In the framework of ordinary differential equations (ODEs), this idea is very old, going back to the late XIX century with the works of Poincaré on Celestial Mechanics, and early XX century with the works of Liapunov and Birkhoff. More recently (1970's), Bibikov and Br'juno gave significant contributions to the field.

Before developing a normal form theory for delay differential equations (DDEs), a brief explanation of the method for ODEs is given.

Consider an autonomous nonlinear ODE in \mathbb{R}^n with an equilibrium at zero,

$$\dot{x}(t) = Bx + f(x) \tag{1.1}$$

where B is an $n \times n$ constant matrix, $f(0) = 0, Df(0) = 0$ and $f \in C^k (k \geq 2)$. The application of the method of n.f. is of interest mostly in the case of a non-hyperbolic equilibrium $x = 0$. In fact, if $x = 0$ is a hyperbolic equilibrium, i.e., all the eigenvalues of B have nonzero real parts, the theorem of Hartman-Grobman assures that, around the origin, Eq. (1.1) is topologically equivalent to the linearization $\dot{x} = Bx$.

Write the Taylor formula for f ,

$$f(x) = \sum_{j=2}^k \frac{1}{j!} f_j(x) + o(|x|^k),$$

where $f_j \in V_j^n(\mathbb{R}^n)$ is the j -th Fréchet derivative of f at zero. Here, we use the notation $V_j^n(Y)$ to denote the space of homogeneous polynomials of degree j in n variables $x = (x_1, \dots, x_n) \in \mathbb{R}^n$, with coefficients in Y , for Y a Banach space.

The method of n.f. consists of a recursive process of changes of variables, such that, at each step j , $2 \leq j \leq k$, all the nonrelevant terms of order j are eliminated from the equation. At a step j , assume that steps of orders $2, \dots, j-1$ have already been performed, leading to

$$\dot{x} = Bx + \frac{1}{2}g_2(x) + \dots + \frac{1}{(j-1)!}g_{j-1}(x) + \frac{1}{j!}\tilde{f}_j(x) + h.o.t.,$$

where $\frac{1}{j!}\tilde{f}_j(x)$ are the terms of order j obtained after the changes of variables in previous steps, and *h.o.t.* stands for higher order terms. A change of variables of the form

$$x = \bar{x} + \frac{1}{j!}U_j(\bar{x}), \quad \text{with } U_j \in V_j^n(\mathbb{R}^n), \quad (1.2)$$

is then applied to the above equation, transforming it into

$$\dot{\bar{x}} = B\bar{x} + \frac{1}{2}g_2(\bar{x}) + \dots + \frac{1}{j!}g_j(\bar{x}) + h.o.t., \quad \bar{x} \in \mathbb{R}^n, \quad (1.3)$$

with the new terms of order j given by

$$g_j = \tilde{f}_j - [B, U_j],$$

where $[B, U_j]$ is the Lie bracket

$$[B, U_j](x) = DU_j(x)Bx - BU_j(x).$$

The operators associated with these changes of variables,

$$M_j : V_j^n(\mathbb{R}^n) \rightarrow V_j^n(\mathbb{R}^n), \quad M_j U = [B, U], \quad (1.4)$$

permit to write $g_j = \tilde{f}_j - M_j U_j$. Hence, one can choose U_j in such a way that

$$g_j \in \text{Im}(M_j)^c,$$

where $Im(M_j)^c$ is a complementary space (in general not uniquely determined) of $Im(M_j)$. Let $P_j : V_j^n(\mathbb{R}^n) \rightarrow Im(M_j)$ be the canonical projection associated with a decomposition

$$V_j^n(\mathbb{R}^n) = Im(M_j) \oplus Im(M_j)^c. \tag{1.5}$$

In order to have

$$g_j = Proj_{Im(M_j)^c} \tilde{f}_j = (I - P_j)\tilde{f}_j, \tag{1.6}$$

U_j must be chosen so that $M_j U_j = P_j \tilde{f}_j$, thus

$$U_j = (M_j)^{-1} P_j \tilde{f}_j, \tag{1.7}$$

where $(M_j)^{-1}$ is a right inverse of M_j , associated with a decomposition $V_j^n(\mathbb{R}^n) = Ker(M_j) \oplus Ker(M_j)^c$. For g_j, U_j defined by (1.6), (1.7), Eq. (1.3) is called a **normal form** for Eq. (1.1), up to j order terms. The terms $\frac{1}{j!}g_j(x) \in Im(M_j)^c$ that cannot be eliminated from (1.1) are called *resonant terms* of order j .

Consider now an equation (1.1) in the form

$$\begin{cases} \dot{x} = Bx + f^1(x, y) \\ \dot{y} = Cy + f^2(x, y), \quad x \in \mathbb{R}^p, y \in \mathbb{R}^m, \end{cases} \tag{1.8}$$

where B is a $p \times p$ matrix, C is an $m \times m$ matrix, $p + m = n$, $Re \lambda(B) = 0$, $Re \lambda(C) \neq 0$, $f^1 : \mathbb{R}^n \rightarrow \mathbb{R}^p$, $f^2 : \mathbb{R}^n \rightarrow \mathbb{R}^m$ are C^k functions ($k \geq 2$) such that $f^1(0, 0) = 0$, $f^2(0, 0) = 0$, $Df^1(0, 0) = 0$, $Df^2(0, 0) = 0$. The centre manifold theorem tells us that there is a centre manifold $W^c = \{(x, y) : y = h(x), x \in V\}$, where V is a neighbourhood of $0 \in \mathbb{R}^p$, tangent at zero to the centre space \mathbb{R}^p for the linearization of (1.8), and that the qualitative behaviour of the flow near zero is determined by its behaviour on the centre manifold.

In order to apply the normal form procedure to the equation for the flow on the centre manifold of (1.8), there are two possible approaches. We can actually compute recursively the function $h(x) = \frac{1}{2}h_2(x) + \dots$ giving the equation of W^c (see e.g. [24]), and therefore write the equation for the flow on such manifold:

$$\dot{x} = Bx + f^1(x, h(x)). \tag{1.9}$$

After this first step, the method of n.f. described above is applied to compute a n.f. for (1.9). This approach is not very efficient, since it requires to compute the centre manifold beforehand.

Another procedure ([29, Chapter 12]) is based on the idea that, at each step j , a change of variables is used to project the original equation (1.8) on the centre manifold and, simultaneously, to eliminate the non-resonant terms of order j from the equation giving the flow on the centre manifold. This is achieved by considering a sequence of change of variables

$$x = \bar{x} + \frac{1}{j!}U_j^1(\bar{x}), \quad y = \bar{y} + \frac{1}{j!}U_j^2(\bar{x}), \quad (1.10)$$

where $U_j^1 \in V_j^p(\mathbb{R}^p), U_j^2 \in V_j^p(\mathbb{R}^m)$. Following the procedure described above, where now the change of variables (1.2) is replaced by (1.10), after steps $j = 2, \dots, k$ Eq. (1.8) is transformed into an equation in the form

$$\begin{cases} \dot{x} = Bx + g_2^1(x, y) + \dots + \frac{1}{k!}g_k^1(x, y) + h.o.t., \\ \dot{y} = Cy + g_2^2(x, y) + \dots + \frac{1}{k!}g_k^2(x, y) + h.o.t., \end{cases} \quad x \in \mathbb{R}^p, y \in \mathbb{R}^m, \quad (1.11)$$

where the new terms $g_j = (g_j^1, g_j^2)$ of orders $j, j = 2, \dots, k$, are given by

$$g_j^1 = \tilde{f}_j^1 - M_j^1 U_j^1, \quad g_j^2 = \tilde{f}_j^2 - M_j^2 U_j^2,$$

with the operators M_j^1 defined as before, $M_j^1 U = [B, U]$, and

$$M_j^2 : V_j^p(\mathbb{R}^m) \rightarrow V_j^p(\mathbb{R}^m), \quad (M_j^2 U)(x) = DU(x)Bx - CU(x). \quad (1.12)$$

Remark 1.1. This latter procedure provides a general setting to be naturally extended to infinite-dimensional spaces, such as the natural phase space for a retarded functional differential equation (FDE) in \mathbb{R}^n . However, some difficulties arise in working in an infinite-dimensional phase space. First of all, it is not clear how to decompose the linear part of an FDE in \mathbb{R}^n so that it can be written as (1.8), where $x \in \mathbb{R}^p \equiv P$, for P the centre space for its linearization at zero, and y in a complementary space P^c for P . Note that the linearization of (1.8) is given by the system

$$\begin{cases} \dot{x} = Bx \\ \dot{y} = Cy, \end{cases} \quad x \in \mathbb{R}^p, y \in \mathbb{R}^m. \quad (1.13)$$

Clearly, a complementary space P^c for P can be obtained by using the formal adjoint theory for linear DDEs in \mathbb{R}^n (cf. [58]), although this is not sufficient to decompose a linear DDE into a decoupled system of linear DDEs similar to (1.13). A second difficulty comes from the fact that the operator M_j^2 in (1.12) will be defined in an infinite-dimensional space $V_j^p(P^c)$. Hence a decomposition similar to (1.5) is not obvious.

Remark 1.2. For the sake of exposition, in general *formal* Taylor series will be considered. Even if f is analytic, the function $g = \frac{1}{2}g_2 + \frac{1}{3!}g_3 + \dots$ in the n.f. is not necessarily analytic. However, in applications this is not a problem, since we are mainly interested in applying n.f. to the study of singularities with possible bifurcations that are generically determined up to a finite jet.

2. Normal Forms for FDEs in Finite Dimensional Spaces

In the next sections, we refer the reader to [58] for notation and general results on the theory of retarded FDEs in finite dimensional spaces.

Consider autonomous semilinear FDEs of retarded type in \mathbb{R}^n (or \mathbb{C}^n) and with an equilibrium point at the origin,

$$\dot{u}(t) = L(u_t) + F(u_t) \quad (t \geq 0), \tag{2.1}$$

where $r > 0$, $C := C([-r, 0]; \mathbb{R}^n)$ is the Banach space of continuous mappings from $[-r, 0]$ to \mathbb{R}^n equipped with the sup norm, $u_t \in C$ is defined by $u_t(\theta) = u(t+\theta)$ for $\theta \in [-r, 0]$, $L : C \rightarrow \mathbb{R}^n$ is a bounded linear operator, and F is a C^k function ($k \geq 2$), with $F(0) = 0, DF(0) = 0$.

Consider also the linearized equation at zero,

$$\dot{u}(t) = L(u_t), \tag{2.2}$$

and its characteristic equation

$$\det \Delta(\lambda) = 0, \quad \Delta(\lambda) := L(e^{\lambda \cdot} I) - \lambda I,$$

where I is the $n \times n$ identity matrix. Let A be the infinitesimal generator for the C_0 -semigroup defined by the flow of (2.2),

$$A : D(A) \subset C \rightarrow C, \quad A\varphi = \dot{\varphi},$$

where $D(A) = \{\varphi \in C : \dot{\varphi} \in C, \dot{\varphi}(0) = L(\varphi)\}$. We recall that A has only the point spectrum, and

$$\sigma(A) = \sigma_P(A) = \{\lambda \in \mathbb{C} : \det \Delta(\lambda) = 0\}.$$

2.1 Preliminaries

For \mathbb{R}^{n*} the n -dimensional vector space of row vectors, define $C^* = C([0, r]; \mathbb{R}^{n*})$, and the formal duality (\cdot, \cdot) in $C^* \times C$,

$$(\psi, \varphi) = \psi(0)\varphi(0) - \int_{-r}^0 \int_0^\theta \psi(\xi - \theta) d\eta(\theta) \varphi(\xi) d\xi, \quad \psi \in C^*, \varphi \in C,$$

where $\eta : [-r, 0] \rightarrow \mathbb{R}^n \times \mathbb{R}^n$ is a function of bounded variation such that

$$L(\varphi) = \int_{-r}^0 d\eta(\theta)\varphi(\theta).$$

The formal adjoint operator A^* of A is defined as the infinitesimal generator for the solution operator of the adjoint equation in C^* ,

$$\dot{y}(t) = - \int_{-r}^0 y(t - \theta)d\eta(\theta), \quad t \leq 0.$$

Fix a nonempty finite set $\Lambda = \{\lambda_1, \dots, \lambda_s\} \subset \sigma(A)$. Using the formal adjoint theory of Hale (see [58, Chapter 7]), the phase space C is decomposed by Λ as

$$C = P \oplus Q,$$

where P is the generalized eigenspace associated with the eigenvalues in Λ , $Q = \{\varphi \in C : (\psi, \varphi) = 0 \text{ for all } \psi \in P^*\}$, and the dual space P^* is the generalized eigenspace for A^* associated with the eigenvalues in Λ . For dual bases Φ and Ψ of P and P^* respectively, such that $(\Psi, \Phi) = I_p$, $p = \dim P$, there exists a $p \times p$ real matrix B with $\sigma(B) = \Lambda$, that satisfies simultaneously $\dot{\Phi} = \Phi B$ and $-\dot{\Psi} = B\Psi$.

2.2 The enlarged phase space

To develop a normal form theory for FDEs, first it is necessary to enlarge the phase space C in such a way that (2.1) is written as an abstract ODE. An adequate phase space to accomplish this is the space BC (see [30, 44, 45]) defined by

$$BC := \{\psi : [-r, 0] \rightarrow \mathbb{R}^n \mid \psi \text{ is continuous on } [-r, 0), \exists \lim_{\theta \rightarrow 0^-} \psi(\theta) \in \mathbb{R}^n\},$$

with the sup norm. The elements of BC have the form $\psi = \varphi + X_0\alpha$, $\varphi \in C$, $\alpha \in \mathbb{R}^n$, where

$$X_0(\theta) = \begin{cases} 0, & -r \leq \theta < 0 \\ I, & \theta = 0, \end{cases} \quad (I \text{ is the } n \times n \text{ identity matrix}),$$

so that BC is identified with $C \times \mathbb{R}^n$ with the norm $|\varphi + X_0\alpha| = |\varphi|_C + |\alpha|_{\mathbb{R}^n}$.

Let $v(t) = u_t \in C$. In BC , Eq. (2.1) takes the form

$$\begin{cases} \frac{dv}{dt}(0) = L(v) + F(v) \\ \frac{dv}{dt}(\theta) = \dot{v}(\theta), \quad \text{for } \theta \in [-r, 0), \end{cases}$$

with the notation $\frac{dv}{d\theta}(\theta) = \dot{v}(\theta), \theta \in [-r, 0]$. Define an extension of the infinitesimal generator A , denoted by \tilde{A} ,

$$\tilde{A} : C^1 \subset BC \rightarrow BC, \quad \tilde{A}\varphi = \dot{\varphi} + X_0[L(\varphi) - \dot{\varphi}(0)],$$

where $D(\tilde{A}) = C^1 := \{\varphi \in C \mid \dot{\varphi} \in C\}$. We then write (2.1) as

$$\frac{dv}{dt} = \tilde{A}v + X_0F(v), \tag{2.3}$$

which is the abstract ODE in BC associated with (2.1). In a natural way, we also extend the duality $(\cdot, \cdot)_{C^* \times C}$ to a bilinear form on $C^* \times BC$ by defining

$$(\psi, X_0\alpha) = \psi(0)\alpha, \quad \psi \in C^*, \alpha \in \mathbb{R}^n.$$

The canonical projection of C onto P associated with the decomposition $C = P \oplus Q$, $\varphi \mapsto \varphi^P = \Phi(\Psi, \varphi)$, is therefore extended to a canonical projection

$$\pi : BC \rightarrow P, \quad \pi(\varphi + X_0\alpha) = \Phi[(\Psi, \varphi) + \Psi(0)\alpha], \quad \varphi \in C, \alpha \in \mathbb{R}^n. \tag{2.4}$$

By using the definition of π and \tilde{A} , and integration by parts, it is easy to prove the following lemma.

Lemma 2.1. π is a continuous projection on BC that commutes with \tilde{A} on $D(\tilde{A}) = C^1$.

Since π is a continuous projection, the decomposition $C = P \oplus Q$ yields a decomposition of BC by Λ as the topological direct sum

$$BC = P \oplus Ker \pi. \tag{2.5}$$

Writing $v \in C^1$ according to the above decomposition, $v = \Phi x + y$, with $x \in \mathbb{R}^p$ ($p = \dim P$), $y \in C^1 \cap Ker \pi = C^1 \cap Q := Q^1$, and since $\pi\tilde{A} = \tilde{A}\pi$ in C^1 , (2.3) becomes

$$\begin{aligned} \Phi \frac{dx}{dt} + \frac{dy}{dt} &= \tilde{A}\Phi x + \tilde{A}y + \pi X_0F(\Phi x + y) + (I - \pi)X_0F(\Phi x + y) \\ &= \dot{\Phi}x + \tilde{A}y + \Phi\Psi(0)F(\Phi x + y) + (I - \pi)X_0F(\Phi x + y). \end{aligned}$$

Therefore, Eq. (2.3) is decomposed as a system of abstract ODEs in $\mathbb{R}^p \times Ker \pi \equiv BC$, as

$$\begin{cases} \dot{x} = Bx + \Psi(0)F(\Phi x + y) \\ \dot{y} = A_{Q^1}y + (I - \pi)X_0F(\Phi x + y), \quad x \in \mathbb{R}^p, y \in Q^1, \end{cases} \tag{2.6}$$

where A_{Q^1} is the restriction of \tilde{A} to Q^1 interpreted as an operator acting in the Banach space $Ker \pi$.

Note that the linear part of system (2.6) looks like (1.13), i.e., the finite dimensional variable x and the infinite dimensional variable y are decoupled in the linear part of the equation. We also point out that the enlarged phase space BC was used by Chow and Mallet-Paret [30] to derive system (2.6). However, since the decomposition (2.5) was not explicitly given in [30], the definition of the linear operator A_{Q^1} in the second equation of (2.6) was not adequate. In fact, the spectrum of A_{Q^1} plays an important role in the construction of normal forms, so it is crucial to restrict \tilde{A} to a linear operator in the Banach space $\text{Ker } \pi$. In this setting, we can prove [44] that

Lemma 2.2. $\sigma(A_{Q^1}) = \sigma_P(A_{Q^1}) = \sigma(A) \setminus \Lambda$.

2.3 Normal form construction

In applications, we are particularly interested in obtaining n.f. for equations giving the flow on centre manifolds. Therefore, and for the sake of exposition, we turn our attention to the case where Λ is the set of eigenvalues of A on the imaginary axis, $\Lambda = \{\lambda \in \sigma(A) : \text{Re } \lambda = 0\} \neq \emptyset$. The centre manifold theorem ([58, Chapter 10] and references therein) assures that there is a p -dimensional invariant manifold for (2.1),

$$W^c = \{\varphi \in C : \varphi = \Phi x + h(x), \text{ for } x \in V\}, \quad (2.7)$$

where V is a neighbourhood of $0 \in \mathbb{R}^p$, which is tangent to the centre space P for (2.2) at zero. From Eq. (2.6), we write the ODE for the flow on W^c as

$$\dot{x} = Bx + \Psi(0)F(\Phi x + h(x)), \quad x \in V. \quad (2.8)$$

The goal now is to develop an algorithm of n.f. which affects simultaneously the linearization of the centre manifold and reduces the ODE (2.8) to a n.f., up to a finite order k . In fact, as we will mention, we can consider any nonempty finite set $\Lambda \subset \sigma(A)$ for which there is an invariant manifold tangent to P at zero, where P is the generalized eigenspace of (2.2) associated with the eigenvalues in Λ . In this case, the method described here is applied to compute a n.f. for the ODE giving the flow on such manifold.

Consider the formal Taylor expansion of F ,

$$F(v) = \sum_{j \geq 2} \frac{1}{j!} F_j(v), \quad v \in C,$$

where F_j is j th Fréchet derivative of F . Eq. (2.6) becomes

$$\begin{cases} \dot{x} = Bx + \sum_{j \geq 2} \frac{1}{j!} f_j^1(x, y) \\ \dot{y} = A_{Q^1} y + \sum_{j \geq 2} \frac{1}{j!} f_j^2(x, y), \quad x \in \mathbb{R}^p, y \in Q^1, \end{cases} \quad (2.9)$$

with $f_j := (f_j^1, f_j^2), j \geq 2$, defined by

$$f_j^1(x, y) = \Psi(0)F_j(\Phi x + y), \quad f_j^2(x, y) = (I - \pi)X_0F_j(\Phi x + y). \quad (2.10)$$

As for autonomous ODEs in \mathbb{R}^n , n.f. are obtained by a recursive process of changes of variables. At a step j , the terms of order $j \geq 2$ are computed from the terms of the same order and from the terms of lower orders already computed in previous steps. Assume that steps of orders $2, \dots, j - 1$ have already been performed, leading to

$$\begin{cases} \dot{x} = Bx + \sum_{\ell=2}^{j-1} \frac{1}{\ell!} g_\ell^1(x, y) + \frac{1}{j!} \tilde{f}_j^1(x, y) + h.o.t. \\ \dot{y} = A_{Q^1} y + \sum_{\ell=2}^{j-1} \frac{1}{\ell!} g_\ell^2(x, y) + \frac{1}{j!} \tilde{f}_j^2(x, y) + h.o.t., \end{cases}$$

where we denote by $\tilde{f}_j = (\tilde{f}_j^1, \tilde{f}_j^2)$ the terms of order j in (x, y) obtained after the previous transformations of variables. At step j , effect a change of variables that has the form

$$(x, y) = (\bar{x}, \bar{y}) + \frac{1}{j!} (U_j^1(\bar{x}), U_j^2(\bar{x})), \quad (2.11j)$$

where $x, \bar{x} \in \mathbb{R}^p, y, \bar{y} \in Q^1$ and $U_j^1 : \mathbb{R}^p \rightarrow \mathbb{R}^p, U_j^2 : \mathbb{R}^p \rightarrow Q^1$ are homogeneous polynomials of degree j in \bar{x} . That is, $U_j^1 \in V_j^p(\mathbb{R}^p), U_j^2 \in V_j^p(Q^1)$, where we adopt the following notation (cf. Section 1): for $j, p \in \mathbb{N}$ and Y a normed space, $V_j^p(Y)$ denotes the space of homogeneous polynomials of degree j in p variables, $x = (x_1, \dots, x_p)$, with coefficients in $Y, V_j^p(Y) = \{\sum_{|q|=j} c_q x^q : q \in \mathbb{N}_0^p, c_q \in Y\}$, with the norm $|\sum_{|q|=j} c_q x^q| = \sum_{|q|=j} |c_q| |Y|$.

This recursive process transforms (2.9) into the *normal form*

$$\begin{cases} \dot{\bar{x}} = B\bar{x} + \sum_{j \geq 2} \frac{1}{j!} g_j^1(\bar{x}, \bar{y}) \\ \dot{\bar{y}} = A_{Q^1} \bar{y} + \sum_{j \geq 2} \frac{1}{j!} g_j^2(\bar{x}, \bar{y}), \end{cases} \quad (2.12)$$

where $g_j := (g_j^1, g_j^2)$ are the new terms of order j , given by

$$\begin{aligned} g_j^1(x, y) &= \tilde{f}_j^1(x, y) - [DU_j^1(x)Bx - BU_j^1(x)] \\ g_j^2(x, y) &= \tilde{f}_j^2(x, y) - [DU_j^2(x)Bx - A_{Q^1}(U_j^2(x))], \quad j \geq 2. \end{aligned}$$

Define the operators $M_j = (M_j^1, M_j^2), j \geq 2$, by

$$\begin{aligned}
 M_j^1 : V_j^P(\mathbb{R}^p) &\rightarrow V_j^P(\mathbb{R}^p), & M_j^2 : V_j^P(Q^1) \subset V_j^P(Ker \pi) &\rightarrow V_j^P(Ker \pi) \\
 (M_j^1 h_1)(x) &= Dh_1(x)Bx - Bh_1(x), & (M_j^2 h_2)(x) &= D_x h_2(x)Bx - A_{Q^1}(h_2(x)).
 \end{aligned}
 \tag{2.13}$$

With $U_j = (U_j^1, U_j^2)$, it is clear that

$$g_j(x, y) = \tilde{f}_j(x, y) - M_j U_j(x),$$

so for $y = 0$ one can define

$$g_j(x, 0) = (I - P_j)\tilde{f}_j(x, 0), \tag{2.14}$$

where I is the identity operator on $V_j^P(\mathbb{R}^p) \times V_j^P(Ker \pi)$ and $P_j = (P_j^1, P_j^2)$ is the canonical projection of $V_j^P(\mathbb{R}^p) \times V_j^P(Ker \pi)$ onto $Im M_j$.

The operators M_j^1 , defined by the Lie brackets, are the operators that appear in Section 1 for computing n.f. for finite-dimensional ODEs. The infinite-dimensional part in the transformation formulas is handled through the operators M_j^2 . Clearly, the ranges of M_j^1, M_j^2 contain exactly the terms that can be removed from the equation, called *non-resonant terms*. The remaining terms (*resonant terms*) are in general not determined in a unique way, depending on the choices of complementary spaces $Im(M_j)^c$ for $Im(M_j)$. We are particularly interested in the situation of M_j^2 surjective and one-to-one, $j \geq 2$.

Theorem 2.3. Assume that the operators $M_j^2, 2 \leq j \leq k$, are one-to-one and onto. Let $(x, y) = \Theta(\bar{x}, \bar{y}) = (\bar{x}, \bar{y}) + O(|\bar{x}|^k)$ be the change of variables obtained after the sequence of transformations (2.11_j), $2 \leq j \leq k$. Then, the local centre manifold W^c for (2.1) defined in (2.7) is transformed into

$$\overline{W}^c = \{\varphi \in C : \varphi = \Phi\bar{x} + h(\bar{x}), \text{ for } \bar{x} \in \overline{V}\},$$

where \overline{V} is a neighbourhood of $0 \in \mathbb{R}^p$, with

$$h(\bar{x}) = o(|\bar{x}|^k).$$

Consequently the flow on \overline{W}^c is given by (after dropping the bars)

$$\dot{x} = Bx + \sum_{j=2}^k g_j^1(x, 0) + o(|x|^k), \quad x \in \overline{V}, \tag{2.15}$$

and the change $(x, y) = \Theta(\bar{x}, \bar{y})$ can be chosen so that (2.15) is in n.f. (in the usual sense of n.f. for ODEs).

Proof. Let Eq. (2.6) be transformed into

$$\begin{cases} \dot{\bar{x}} = B\bar{x} + \sum_{j=2}^k \frac{1}{j!} g_j^1(\bar{x}, \bar{y}) + h.o.t. \\ \dot{\bar{y}} = A_{Q^1}\bar{y} + \sum_{j=2}^k \frac{1}{j!} g_j^2(\bar{x}, \bar{y}) + h.o.t., \end{cases} \tag{2.16}$$

through the change $(x, y) = \Theta(\bar{x}, \bar{y})$. Write $h(x) = \frac{1}{2}h_2(x) + o(|x|^2)$. For $y = h(x)$, from (2.16) we get

$$Dh(x)\dot{x} = A_{Q^1}(h(x)) + \frac{1}{2}g_2^2(x, h(x)) + O(|x|^4).$$

Using again (2.16), we have

$$\frac{1}{2}Dh_2(x)[Bx + O(|x|^2)] + O(|x|^3) = \frac{1}{2}A_{Q^1}(h_2(x)) + \frac{1}{2}g_2^2(x, 0) + O(|x|^3).$$

From (2.14), we conclude that $g_2^2(x, 0) = 0$, because M_2^2 is onto. Hence

$$Dh_2(x)Bx - A_{Q^1}(h_2(x)) = 0,$$

that is, $M_2^2h_2 = 0$. Since M_2^2 is one-to-one, this implies that $h_2 = 0$, and thus $y = o(|x|^2)$. On the other hand, since the operators M_j^1 coincide with the operators in the algorithm for computing n.f. for ODEs in \mathbb{R}^p , equation

$$\dot{\bar{x}} = B\bar{x} + \frac{1}{2}g_2^1(\bar{x}, 0) + h.o.t$$

is a n.f. for (2.8) up to second order terms. The rest of the proof follows by induction. ■

Since A is the infinitesimal generator of a C_0 -semigroup, it is a closed operator. This implies that the extension \tilde{A} is also a closed operator. Note that the restriction $A_{Q^1} = \tilde{A}|_{Q^1}$ is an operator acting in the Banach space $Ker \pi$, therefore A_{Q^1} is also closed. Thus, it is straightforward to prove that M_j^2 , $j \geq 2$, are closed operators in the Banach space $V_j^p(Ker \pi)$, so M_j^2 are one-to-one and onto if and only if $0 \notin \sigma(M_j^2)$. The spectra of the operators M_j^2 are given in the theorem below.

Theorem 2.4. With the above notations,

(i) $\sigma_P(M_j^2) = \{(q, \bar{\lambda}) - \mu : \mu \in \sigma(A_Q^1), q \in D_j\}$;

(ii) $\sigma(M_j^2) = \sigma_P(M_j^2)$,

where: $D_j = \{q \in \mathbb{N}_0^p : |q| = j\}$; $|q| = q_1 + \dots + q_p$ for $q = (q_1, \dots, q_p)$; $\bar{\lambda} = (\lambda_1, \dots, \lambda_p)$ where $\lambda_1, \dots, \lambda_p$ are the eigenvalues in Λ , counting multiplicities; $(q, \bar{\lambda}) = q_1\lambda_1 + \dots + q_p\lambda_p$.

Proof. The complete proof of this theorem can be found in [44]. (See also [45] for the situation of DDEs with parameters.) Here we give only a sketch of the proof.

By adapting the algebraic arguments for finite ODEs in [29, Chapter 12], one can prove (i). To prove (ii), it is sufficient to show that if $\alpha \notin \sigma_P(M_j^2)$, then the operator $\alpha I - M_j^2$ is surjective. In order to prove this, consider the set D_j with the following order: for $q = (q_1, \dots, q_p)$ and $\ell = (\ell_1, \dots, \ell_p)$ in D_j , we say that $q < \ell$ if the first non-zero difference $q_1 - \ell_1, \dots, q_p - \ell_p$ is positive. In this order, $(j, 0, \dots, 0)$ is the first element in D_j , and $(0, \dots, 0, j)$ is the last element.

Let $\alpha \notin \sigma_P(M_j^2)$. From (i), we deduce that $\mu_q := (q, \bar{\lambda}) - \alpha \in \rho(A_{Q^1})$ for all $q \in D_j$. Fix $g = \sum_{q \in D_j} g_q x^q \in V_j^p(Ker \pi)$. By induction in D_j ordered as above, for any $q \in D_j$ it is possible to construct

$$h^{(q)} = \sum_{\ell \in D_j} h_\ell x^\ell$$

such that

$$[(\alpha I - M_j^2)h^{(q)}]_\ell = g_\ell \quad \text{for } \ell \leq q.$$

For q the last element of D_j , we get $(\alpha I - M_j^2)h^{(q)} = g$, proving that $\alpha I - M_j^2$ is surjective. ■

Corollary 2.5. The operators M_j^2 defined in (2.13) are one-to-one and onto if and only if

$$(q, \bar{\lambda}) \neq \mu, \quad \text{for all } \mu \in \sigma(A) \setminus \Lambda \text{ and } q \in D_j. \tag{2.17_j}$$

Proof. From Theorem 2.4 and Lemma 2.2 it follows immediately that $0 \notin \sigma_P(M_j^2) = \sigma(M_j^2)$ if and only if (2.17_j) holds. ■

Conditions (2.17_j) are called *non-resonance conditions of order j*, relative to the set Λ .

Theorem 2.6. Let $\Lambda = \{\lambda \in \sigma(A) : Re \lambda = 0\} \neq \emptyset$, and BC be decomposed by Λ , $BC \equiv \mathbb{R}^p \times Ker \pi$. Then, there is a formal change of variables of the form

$$(x, y) = (\bar{x}, \bar{y}) + O(|\bar{x}|^2),$$

such that:

- (i) Eq. (2.9) is transformed into Eq. (2.12) where $g_j^2(\bar{x}, 0) = 0, j \geq 2$;
- (ii) a local centre manifold for this system at zero satisfies $\bar{y} = 0$;
- (iii) the flow on it is given by the ODE in \mathbb{R}^p

$$\dot{\bar{x}} = B\bar{x} + \sum_{j \geq 2} \frac{1}{j!} g_j^1(\bar{x}, 0), \tag{2.18}$$

which is in normal form (in the usual sense of n.f. for ODEs).

Proof. For the choice $\Lambda = \{\lambda \in \sigma(A) : \text{Re } \lambda = 0\}$, clearly the non-resonance conditions (2.17_j) hold for any $j \geq 2$. Therefore, $\text{Im}(M_j^2) = V_j^p(\text{Ker } \pi)$ and $\text{Ker}(M_j^2) = \{0\}, j \geq 2$. From (2.14), we can choose U_j^2 such that $g_j^2(x, 0) = \tilde{f}_j^2(x, 0) - (M_j^2 U_j^2)(x) = 0$. Theorem 2.3 implies that the centre manifold is given by equation $\bar{y} = 0$ (up to a certain order k , if F is C^k -smooth), and that the flow on this manifold is given by (2.18), which is an ODE in n.f. ■

For other choices of finite nonempty sets $\Lambda \subset \sigma(A)$, this n.f. procedure is justified if the non-resonance conditions hold.

Theorem 2.7. Let $\Lambda \subset \sigma(A)$ be a nonempty finite set. If the nonresonance conditions (2.17_j) hold for $j \geq 2$, the statements in the above theorem are valid for the invariant manifold for (2.1) associated with Λ , provided that this manifold exists.

Definition 2.8. If the nonresonance conditions (2.17_j), $j \geq 2$, are satisfied, Eq. (2.12) is said to be a **normal form** for Eq. (2.9) (or Eq. (2.1)) **relative to** Λ if $g_j = (g_j^1, g_j^2)$ are defined by

$$g_j(x, y) = \tilde{f}_j(x, y) - M_j U_j(x),$$

with $U_j = (U_j^1, U_j^2)$,

$$U_j^2(x) = (M_j^2)^{-1} \tilde{f}_j^2(x, 0)$$

and U_j^1 ($j \geq 2$) are chosen according to the method of n. f. for finite dimensional ODEs: i.e.,

$$g_j^1(x, 0) = (I - P_j^1) \tilde{f}_j^1(x, 0), \quad U_j^1(x) = (M_j^1)^{-1} P_j^1 \tilde{f}_j^1(x, 0), j \geq 2,$$

where $P_j^1 : V_j^p(\mathbb{R}^p) \rightarrow \text{Im}(M_j^1)$ is the canonical projection associated with a decomposition $V_j^p(\mathbb{R}^p) = \text{Im}(M_j^1) \oplus \text{Im}(M_j^1)^c$, and $(M_j^1)^{-1} : \text{Im}(M_j^1) \rightarrow \text{Ker}(M_j^1)^c$ is the right inverse of M_j^1 for a decomposition $V_j^p(\mathbb{R}^p) = \text{Ker}(M_j^1) \oplus \text{Ker}(M_j^1)^c$.

Remark 2.9. Note that P_j^1 and $(M_j^1)^{-1}$ depend on the choices of complementary spaces for $\text{Im}(M_j^1)$ and $\text{Ker}(M_j^1)$ in $V_j^p(\mathbb{R}^p)$, respectively. On the other hand, if $F \in C^k$ for some $k \geq 2$, and the nonresonance conditions of order j , $2 \leq j \leq k$, hold, one can compute Eq. (2.16), a n.f. relative to Λ up to k -order terms.

Remark 2.10. The terms $g_j^1(x, 0)$ in the n.f. are recursively computed in terms of the coefficients of the original FDE, according to the following scheme: in the first step ($j = 2$), we have $\tilde{f}_2^1 = f_2^1$, from which we

compute $g_2^1(x, 0) = (I - P_2^1)f_2^1(x, 0)$; in the second step ($j = 3$), we must compute $U_2^1(x) = (M_2^1)^{-1}P_2^1f_2^1(x, 0)$, $U_2^2(x) = (M_2^2)^{-1}f_2^2(x, 0)$, and

$$\tilde{f}_3^1(x, 0) = f_3^1(x, 0) + \frac{3}{2}[(D_x f_2^1)(x, 0)U_2^1(x) + (D_y f_2^1)(x, 0)U_2^2(x) - (D_x U_2^1)(x)g_2^1(x, 0)], \quad (2.19)$$

from which we finally obtain $g_3^1(x, 0) = (I - P_3^1)\tilde{f}_3^1(x, 0)$; etc.

2.4 Equations with parameters

For studying bifurcation problems, we need to consider situations with parameters:

$$\dot{u}(t) = L(\alpha)(u_t) + F(u_t, \alpha), \quad (2.20)$$

where $\alpha \in V$, V is a neighbourhood of zero in \mathbb{R}^m , and $L : V \rightarrow \mathcal{L}(C; \mathbb{R}^n)$, $F : C \times V \rightarrow \mathbb{R}^n$ are respectively C^{k-1} and C^k functions, $k \geq 2$, $F(0, \alpha) = 0$, $D_1 F(0, \alpha) = 0$, for all $\alpha \in V$. As usual, $\mathcal{L}(C; \mathbb{R}^n)$ denotes the space of bounded linear operators from C to \mathbb{R}^n , with the operator norm. Introducing the parameter α as a variable by adding $\dot{\alpha} = 0$, we write (2.20) as

$$\begin{aligned} \dot{u}(t) &= L_0(u_t) + (L(\alpha) - L_0)(u_t) + F(u_t, \alpha) \\ (\dot{\alpha}(t) &= 0), \end{aligned} \quad (2.21)$$

where $L_0 := L(0)$. Clearly the phase space for (2.21) is $C([-r, 0]; \mathbb{R}^{n+m})$. Its linearization around the origin is

$$\begin{pmatrix} \dot{u}(t) \\ \dot{\alpha}(t) \end{pmatrix} = \begin{pmatrix} L_0(u_t) \\ 0 \end{pmatrix}.$$

Note that the term $(L(\alpha) - L_0)(u_t)$ is no longer of the first order, since α is taken as a variable.

Consider a finite nonempty set $\Lambda \subset \sigma(A)$ such that $0 \in \Lambda$ if $0 \in \sigma(A)$, and let $C = P \oplus Q$ be decomposed by Λ . Writing the Taylor expansions

$$\begin{aligned} L(\alpha)(u) &= L_0 u + L_1(\alpha)u + \frac{1}{2}L_2(\alpha)u + \cdots \\ F(u, \alpha) &= \frac{1}{2}F_2(u, \alpha) + \frac{1}{3!}F_3(u, \alpha) + \cdots, \quad u \in C, \alpha \in V, \end{aligned}$$

the term of order j in the variables (u, α) for (2.21) is given by

$$\frac{1}{(j-1)!}L_{j-1}(\alpha)u + \frac{1}{j!}F_j(u, \alpha).$$

Therefore, the terms (2.10) for the equation (2.6) in BC read now as

$$\begin{aligned} f_j^1(x, y, \alpha) &= \Psi(0)[jL_{j-1}(\alpha)(\Phi x + y) + F_j(\Phi x + y, \alpha)], \\ f_j^2(x, y, \alpha) &= (I - \pi)X_0[jL_{j-1}(\alpha)(\Phi x + y) + F_j(\Phi x + y, \alpha)]. \end{aligned} \tag{2.22}$$

The above procedure can now be applied to compute n.f. for (2.11). See [45] for details.

2.5 More about normal forms for FDEs in \mathbb{R}^n

In [99], the n.f. theory presented here was generalized to construct n.f. for *neutral* FDEs of the form

$$\frac{d}{dt} [D(u_t) - G(u_t)] = L(u_t) + F(u_t), \tag{2.23}$$

where $u_t \in C$, D, L are bounded linear operators from C to \mathbb{R}^n , with $D\phi = \phi(0) - \int_{-r}^0 d[\mu(\theta)]\phi(\theta)$ and μ is non-atomic at zero, $\mu(0) = 0$, and G, F are C^k functions, $k \geq 2$. Following the ideas above, in [99] the infinitesimal generator general A for the semigroup defined by the solutions of the linear equation

$$\frac{d}{dt} D(u_t) = L(u_t)$$

was naturally extended to

$$\tilde{A} : C^1 \subset BC \rightarrow BC, \quad \tilde{A}\varphi = \dot{\varphi} + X_0[L(\varphi) - D\dot{\varphi}], \tag{2.24}$$

where $D(\tilde{A}) = C^1$. Fix e.g. Λ as the set of eigenvalues of A on the imaginary axis, and consider $C = P \oplus Q$ and $BC = P \oplus Ker \pi$ decomposed by Λ . Since the projection π in (2.4) still commutes in C^1 with the operator \tilde{A} given by (2.24), in BC (2.23) is written as the abstract ODE

$$\dot{v} = \tilde{A}v + X_0[F(v) + G'(v)\dot{v}],$$

and decomposition (2.5) yields

$$\begin{cases} \dot{x} = Bx + \Psi(0)[F(\Phi x + y) + G'(\Phi x + y)(\Phi \dot{x} + \dot{y})] \\ \dot{y} = A_{Q^1}y + (I - \pi)X_0[F(\Phi x + y) + G'(\Phi x + y)(\Phi \dot{x} + \dot{y})], \end{cases} \quad x \in \mathbb{R}^p, y \in Q^1,$$

where A_{Q^1} is the restriction of \tilde{A} to Q^1 interpreted as an operator acting in the Banach space $Ker \pi$. Define again the operators M_j^1, M_j^2 by the formal expression (2.13), where now \tilde{A} is as in (2.24). Lemmas 2.1 and 2.2 are true in this framework. The method for computing n.f. on centre

manifolds (or other invariant manifolds) for neutral equations (2.23) is then developed in [99] along the lines of the method for FDEs (2.1).

It would also be very important to generalize the above method to construct n.f. around periodic orbits for autonomous retarded FDEs on $C = C([-r, 0]; \mathbb{R}^n)$

$$\dot{u}(t) = f(u_t), \quad (2.25)$$

with $f \in C^k (k \geq 2)$. Suppose that $p(t)$ is an ω -periodic solution of (2.25). Through the change $u(t) = p(t) + x(t)$, (2.25) becomes

$$\dot{x}(t) = L(t)x_t + F(t, x_t), \quad (2.26)$$

where $L(t) = Df(p_t)$ and $F(t, \varphi) = f(p_t + \varphi) - f(p_t) - Df(p_t)\varphi$ are ω -periodic functions in t .

The major difficulty when trying to generalize the theory of n.f. to an FDE of the form (2.26) is that its linear part is non-autonomous. In [35], the theory was developed for the particular case of equations (2.26) with *autonomous* linear part,

$$\dot{x}(t) = Lx_t + F(t, x_t). \quad (2.27)$$

Clearly, condition $L(t) \equiv L$ is very restrictive. However, in this case, the work in [35] provides a strong result.

Theorem 2.11. With the above notations, let $\Lambda = \{\lambda \in \sigma(A) : \operatorname{Re} \lambda = 0\}$ and assume Λ is nonempty. If the nonresonance conditions

$$(q, \bar{\lambda}) + ik \neq \mu, \quad \text{for all } \mu \in \sigma(A) \setminus \Lambda, \quad k \in \mathbf{Z}, \quad q \in D_j, \quad j \geq 2$$

are satisfied, the normal form on the centre manifold for (2.27) coincides with the normal form for the averaged equation

$$\dot{x}(t) = Lx_t + F_0(x_t),$$

where

$$F_0(\varphi) = \frac{1}{\omega} \int_0^\omega F(t, \varphi) dt, \quad \varphi \in C.$$

To treat the general periodic case (2.26), it may be useful to use the work of Hale and Weebermann [59], where a suitable system of coordinates was established, and used to deduce a natural decomposition of C . If the new coordinates allow us to decompose also the enlarged phase space BC , then (2.26) can be written as an abstract ODE in BC .

3. Normal forms and Bifurcation Problems

In this section we illustrate the application of the method of n.f. to the study of Bogdanov-Takens and Hopf bifurcations for general scalar FDEs. In the framework of FDEs in $\mathbb{R}^n, n \geq 2$, with one or two discrete delays, for other examples of applications of n.f. to bifurcation problems see e.g. [38, 40, 41, 47, 57, 102, 103].

3.1 The Bogdanov-Takens bifurcation

We start by studying the Bogdanov-Takens singularity for a general scalar FDE. In $C = C([-r, 0]; \mathbb{R})$, consider

$$\dot{u}(t) = L(\alpha)u_t + F(u_t, \alpha), \tag{3.1}$$

where $\alpha = (\alpha_1, \alpha_2) \in V \subset \mathbb{R}^2, V$ a neighbourhood of zero, $L : V \rightarrow \mathcal{L}(C; \mathbb{R})$ is $C^1, F : C \times V \rightarrow \mathbb{R}$ is $C^2, F(0, \alpha) = 0, D_1F(0, \alpha) = 0$ for $\alpha \in V$.

Let $L(0) = L_0$. For the linearization at $u = 0, \alpha = 0$, we assume:

(H1) $\lambda = 0$ is a double characteristic value of $\dot{u}(t) = L_0u_t$:

$$L_0(1) = 0, L_0(\theta) = 1, L_0(\theta^2) \neq 0;$$

(H2) all other characteristic values of $\dot{u}(t) = L_0u_t$ have non-zero real parts

Above and throughout this section, we often abuse the notation and write $L_0(\varphi(\theta))$ for $L_0(\varphi), \varphi \in C$.

With the notations in Section 2, fix $\Lambda = \{0\}$, and let $C = P \oplus Q, BC = P \oplus Ker \pi$ be decomposed by Λ . Choose bases Φ and Ψ for the the centre space P of $\dot{u}(t) = L_0u_t$, and for its dual P^* :

$$P = \text{span } \Phi, \quad \Phi(\theta) = (1, \theta), \quad \theta \in [-r, 0],$$

$$P^* = \text{span } \Psi, \quad \Psi(s) = \begin{pmatrix} \psi_1(0) - s\psi_2(0) \\ \psi_2(0) \end{pmatrix}, \quad s \in [0, r],$$

with $(\Psi, \Phi) = I$ if

$$\psi_1(0) = L_0(\theta^2/2)^{-2}L_0(\theta^3/3!), \quad \psi_2(0) = -L_0(\theta^2/2)^{-1}. \tag{3.2}$$

Also, $\dot{\Phi} = \Phi B, -\dot{\Psi} = B\Psi$ for

$$B = \begin{pmatrix} 0 & 1 \\ 0 & 0 \end{pmatrix}.$$

Thus, for $\alpha = 0$ the 2-dimensional ODE on the centre manifold has a Bogdanov-Takens singularity. Consequently its dynamics around $u = 0$ are generically determined by its quadratic terms [24, 29].

Consider the Taylor expansions

$$L(\alpha) = L_0 + L_1(\alpha) + O(|\alpha|^2),$$

$$F(u, \alpha) = \frac{1}{2}F_2(u, \alpha) + O(|u|^3 + |\alpha||u|^2).$$

From Theorem 2.6 (see also Remark 2.9), we deduce that the n.f. up to quadratic terms on the centre manifold of the origin near $\alpha = 0$ is given by

$$\dot{x} = Bx + \frac{1}{2}g_2^1(x, 0, \alpha) + h.o.t.,$$

where $x = (x_1, x_2) \in \mathbb{R}^2$, and (conf. (2.22))

$$g_2^1(x, 0, \alpha) = Proj_{Im(M_2^1)^c} f_2^1(x, 0, \alpha),$$

$$f_2^1(x, 0, \alpha) = \Psi(0)[2L_1(\alpha)(\Phi x) + F_2(\Phi x, \alpha)].$$

From the definition of M_2^1 in (2.13), we have

$$M_2^1 \begin{pmatrix} p_1 \\ p_2 \end{pmatrix} = \begin{pmatrix} \frac{\partial p_1}{\partial x_1} x_2 - p_2 \\ \frac{\partial p_2}{\partial x_1} x_2 \end{pmatrix}, \quad \begin{pmatrix} p_1 \\ p_2 \end{pmatrix} \in V_2^4(\mathbb{R}^2).$$

Decomposing $V_2^4(\mathbb{R}^2) = Im(M_2^1) \oplus Im(M_2^1)^c$, a possible choice for $Im(M_2^1)^c$ is

$$S := Im(M_2^1)^c = span \left\{ \begin{pmatrix} 0 \\ x_1^2 \end{pmatrix}, \begin{pmatrix} 0 \\ x_1 x_2 \end{pmatrix}, \begin{pmatrix} 0 \\ x_1 \alpha_1 \end{pmatrix}, \begin{pmatrix} 0 \\ x_1 \alpha_2 \end{pmatrix}, \begin{pmatrix} 0 \\ x_2 \alpha_1 \end{pmatrix}, \begin{pmatrix} 0 \\ x_2 \alpha_2 \end{pmatrix}, \right.$$

$$\left. \begin{pmatrix} 0 \\ \alpha_1^2 \end{pmatrix}, \begin{pmatrix} 0 \\ \alpha_1 \alpha_2 \end{pmatrix}, \begin{pmatrix} 0 \\ \alpha_2^2 \end{pmatrix} \right\}.$$

Note that

$$\frac{1}{2}f_2^1(x, 0, \alpha) = \begin{pmatrix} \psi_1(0) \\ \psi_2(0) \end{pmatrix} \{L_1(\alpha)(\varphi_1 x_1 + \varphi_2 x_2) + \frac{1}{2}F_2(\varphi_1 x_1 + \varphi_2 x_2, 0)\}.$$

Write

$$F_2(\Phi x, \alpha) = F_2(\Phi x, 0) = A_{(2,0)}x_1^2 + A_{(1,1)}x_1x_2 + A_{(0,2)}x_2^2.$$

On the other hand, from the definition of M_2^1 and the choice of S , we deduce that the projection on S of the elements of the canonical basis

for $V_2^4(\mathbb{R}^2)$,

$$\begin{aligned} & \begin{pmatrix} x_1^2 \\ 0 \end{pmatrix}, \begin{pmatrix} x_1x_2 \\ 0 \end{pmatrix}, \begin{pmatrix} x_2^2 \\ 0 \end{pmatrix}, \begin{pmatrix} x_1\alpha_i \\ 0 \end{pmatrix}, \begin{pmatrix} x_2\alpha_i \\ 0 \end{pmatrix}, \quad (i = 1, 2) \\ & \begin{pmatrix} 0 \\ x_1^2 \end{pmatrix}, \begin{pmatrix} 0 \\ x_1x_2 \end{pmatrix}, \begin{pmatrix} 0 \\ x_2^2 \end{pmatrix}, \begin{pmatrix} 0 \\ x_1\alpha_i \end{pmatrix}, \begin{pmatrix} 0 \\ x_2\alpha_i \end{pmatrix}, \quad (i = 1, 2) \end{aligned}$$

are, respectively,

$$\begin{aligned} & \begin{pmatrix} 0 \\ 2x_1x_2 \end{pmatrix}, \begin{pmatrix} 0 \\ 0 \end{pmatrix}, \begin{pmatrix} 0 \\ 0 \end{pmatrix}, \begin{pmatrix} 0 \\ x_2\alpha_i \end{pmatrix}, \begin{pmatrix} 0 \\ 0 \end{pmatrix}, \quad (i = 1, 2) \\ & \begin{pmatrix} 0 \\ x_1^2 \end{pmatrix}, \begin{pmatrix} 0 \\ x_1x_2 \end{pmatrix}, \begin{pmatrix} 0 \\ 0 \end{pmatrix}, \begin{pmatrix} 0 \\ x_1\alpha_i \end{pmatrix}, \begin{pmatrix} 0 \\ x_2\alpha_i \end{pmatrix}, \quad (i = 1, 2). \end{aligned}$$

Hence

$$\frac{1}{2}g_2^1(x, 0, \alpha) = \begin{pmatrix} 0 \\ \lambda_1x_1 + \lambda_2x_2 \end{pmatrix} + \begin{pmatrix} 0 \\ B_1x_1^2 + B_2x_1x_2 \end{pmatrix},$$

with

$$\begin{aligned} B_1 &= \frac{1}{2}\psi_2(0)A_{(2,0)} \\ B_2 &= \psi_1(0)A_{(2,0)} + \frac{1}{2}\psi_2(0)A_{(1,1)} \end{aligned} \tag{3.3}$$

and

$$\begin{aligned} \lambda_1 &= \psi_2(0)L_1(\alpha)(1) \\ \lambda_2 &= \psi_1(0)L_1(\alpha)(1) + \psi_2(0)L_1(\alpha)(\theta). \end{aligned} \tag{3.4}$$

We remark that the bifurcation parameters λ_1, λ_2 and the coefficients B_1, B_2 are explicitly computed in terms of the coefficients in the original equation (3.1). Also, the new bifurcating parameters λ_1, λ_2 are linearly independent. We summarize the above computations in the following result:

Theorem 3.1. For α small, the flow on the centre manifold for (3.1) is given by the n. f. (up to quadratic terms)

$$\begin{cases} \dot{x}_1 = x_2 + h.o.t \\ \dot{x}_2 = \lambda_1x_1 + \lambda_2x_2 + B_1x_1^2 + B_2x_1x_2 + h.o.t, \end{cases} \tag{3.5}$$

where the coefficients B_1, B_2 and the new bifurcating parameters λ_1, λ_2 are as in (3.3) and (3.4). Furthermore, if $B_1B_2 \neq 0$, (3.5) exhibits a generic Bogdanov-Takens bifurcation from $u = 0, \alpha = 0$.

The bifurcation diagram for the flow on the centre manifold depends on the signs of B_1, B_2 . For instance, let $B_1 < 0$ and $B_2 > 0$. Then in

the (λ_1, λ_2) -bifurcation diagram, the Hopf bifurcation curve H and the homoclinic bifurcation curve HL lie in the region $\lambda_1 > 0, \lambda_2 < 0$, with H to the left of HL , and both the homoclinic loop and the periodic orbit are asymptotically stable. (See e.g. [24, 29]).

Example 3.2. Consider the scalar DDE

$$\dot{u}(t) = a_1u(t) - a_2u(t-1) + au^2(t) + bu(t)u(t-1) + cu^2(t-1), \quad (3.6)$$

where $a_1, a_2, a, b, c \in \mathbb{R}$. The characteristic equation for its linearization at zero, $\dot{u}(t) = a_1u(t) - a_2u(t-1)$, is given by

$$\Delta(\lambda) := \lambda - a_1 + a_2e^{-\lambda} = 0.$$

One can check that $\lambda = 0$ is a double characteristic value, i.e., $\Delta(0) = 0, \Delta'(0) = 0$ and $\Delta''(0) \neq 0$, if and only if $a_1 = a_2 = 1$.

Rescaling the parameters by setting $\alpha_1 = a_1 - 1, \alpha_2 = a_2 - 1, \alpha = (\alpha_1, \alpha_2) \in \mathbb{R}^2$, (3.6) becomes

$$\dot{u}(t) = u(t) - u(t-1) + \alpha_1u(t) - \alpha_2u(t-1) + au^2(t) + bu(t)u(t-1) + cu^2(t-1),$$

so it has the form (2.21), with the linear terms in $(u_t, \alpha) \in C \times \mathbb{R}^2$ given by $L_0(u_t)$, and non-linear terms $L_1(\alpha)(u_t) + F(u_t)$, where $L_0(\varphi) = \varphi(0) - \varphi(-1), L_1(\alpha)(\varphi) = \alpha_1\varphi(0) - \alpha_2\varphi(-1)$ and $F(\varphi) = a\varphi^2(0) + b\varphi(0)\varphi(-1) + c\varphi(-1)^2$, for $\varphi \in C = C([-1, 0]; \mathbb{R})$.

Fix $\Lambda = \{0\}$, and consider dual basis Φ, Ψ as above. We get $\psi_1(0) = 2/3, \psi_2(0) = 2$ from (3.2), and $F_2(\Phi x, 0)/2 = (a+b+c)x_1^2 - (b+2c)x_1x_2 + cx_2^2$. Applying formulas (3.3)-(3.4), we deduce that the ODE on the centre manifold of the origin near $\alpha = 0$ is given in n.f. by (3.5) with

$$\begin{aligned} B_1 &= 2(a + b + c), & B_2 &= \frac{2}{3}(2a - b - 4c) \\ \lambda_1 &= 2(\alpha_1 - \alpha_2), & \lambda_2 &= \frac{2}{3}(\alpha_1 + 2\alpha_2). \end{aligned}$$

3.2 Hopf bifurcation

We study the generic Hopf bifurcation for the general scalar case. In the phase space $C = C([-r, 0]; \mathbb{R})$, consider

$$\dot{u}(t) = L(\alpha)u_t + F(u_t, \alpha), \quad (3.7)$$

where $\alpha \in V, V$ a neighbourhood of zero in $\mathbb{R}, L : V \rightarrow \mathcal{L}(C; \mathbb{R})$ is C^2 , and $F : C \times V \rightarrow \mathbb{R}$ is $C^3, F(0, \alpha) = 0, D_1F(0, \alpha) = 0$ for $\alpha \in V$.

For $\dot{u}(t) = L(\alpha)(u_t)$, assume that:

(H1) there is a pair of simple characteristic roots $\gamma(\alpha) \pm i\omega(\alpha)$ for $\dot{u}(t) = L(\alpha)u_t$ crossing transversely the imaginary axis at $\alpha = 0$:

$$\gamma(0) = 0, \quad \omega := \omega(0) > 0, \quad \gamma'(0) \neq 0 \quad (\text{Hopf condition});$$

(H2) for $\alpha = 0$, there are no other characteristic roots with zero real parts.

With the notations above, and using complex coordinates, C is decomposed by $\Lambda = \{i\omega, -i\omega\}$ as $C = P \oplus Q$, where the dual bases Φ, Ψ for P, P^* can be chosen as

$$P = \text{span } \Phi, \quad \Phi(\theta) = (\varphi_1(\theta), \varphi_2(\theta)) = (e^{i\omega\theta}, e^{-i\omega\theta}), \quad -r \leq \theta \leq 0$$

$$P^* = \text{span } \Psi, \quad \Psi(s) = \begin{pmatrix} \psi_1(s) \\ \psi_2(s) \end{pmatrix} = \begin{pmatrix} \psi_1(0)e^{-i\omega s} \\ \psi_2(0)e^{i\omega s} \end{pmatrix}, \quad 0 \leq s \leq r,$$

with $(\Psi, \Phi) = I$ if

$$\psi_1(0) = (1 - L_0(\theta e^{i\omega\theta}))^{-1}, \quad \psi_2(0) = \overline{\psi_1(0)}. \tag{3.8}$$

Note that $\dot{\Phi} = \Phi B, -\dot{\Psi} = B\Psi$ for

$$B = \begin{pmatrix} i\omega & 0 \\ 0 & -i\omega \end{pmatrix}.$$

Since B is a diagonal matrix, because of the use of complex coordinates, the operators M_j^1 have a diagonal matrix representation in the canonical basis of $V_j^3(\mathbb{C}^2)$; in particular,

$$V_j^3(\mathbb{C}^2) = \text{Im}(M_j^1) \oplus \text{Ker}(M_j^1), \quad j \geq 2.$$

Write the Taylor expansions

$$L(\alpha) = L_0 + \alpha L_1 + \frac{\alpha^2}{2} L_2 + h.o.t., \quad F(\varphi, \alpha) = \frac{1}{2} F_2(\varphi, \alpha) + \frac{1}{3!} F_3(\varphi, \alpha) + h.o.t..$$

The Hopf condition assures that a Hopf bifurcation occurs on a two dimensional centre manifold of the origin. The generic Hopf bifurcation is determined up to cubic terms. Applying the method of n.f., we have the n.f. on the center manifold up to third order terms given by

$$\dot{x} = Bx + \frac{1}{2} g_2^1(x, 0, \alpha) + \frac{1}{3!} g_3^1(x, 0, \alpha) + h.o.t.,$$

where g_2^1, g_3^1 are the second and third order terms in (x, α) , respectively:

$$\begin{aligned} \frac{1}{2}g_2^1(x, 0, \alpha) &= \frac{1}{2}Proj_{Ker(M_2^1)}f_2^1(x, 0, \alpha), \\ \frac{1}{3!}g_3^1(x, 0, \alpha) &= \frac{1}{3!}Proj_{Ker(M_3^1)}\tilde{f}_3^1(x, 0, \alpha). \end{aligned}$$

The operators M_j^1 are defined by

$$M_j^1(\alpha^l x^q e_k) = i\omega(q_1 - q_2 + (-1)^k)\alpha^l x^q e_k,$$

for $l + q_1 + q_2 = j, k = 1, 2, j = 2, 3, q = (q_1, q_2) \in \mathbb{N}_0^2, l \in \mathbb{N}_0,$
 $e_1 = \begin{pmatrix} 1 \\ 0 \end{pmatrix}, e_2 = \begin{pmatrix} 0 \\ 1 \end{pmatrix}$. Hence,

$$\begin{aligned} Ker(M_2^1) &= span\left\{ \begin{pmatrix} x_1\alpha \\ 0 \end{pmatrix}, \begin{pmatrix} 0 \\ x_2\alpha \end{pmatrix} \right\} \\ Ker(M_3^1) &= span\left\{ \begin{pmatrix} x_1^2x_2 \\ 0 \end{pmatrix}, \begin{pmatrix} x_1\alpha^2 \\ 0 \end{pmatrix}, \begin{pmatrix} 0 \\ x_1x_2^2 \end{pmatrix}, \begin{pmatrix} 0 \\ x_2\alpha^2 \end{pmatrix} \right\}. \end{aligned}$$

Note that

$$g_3^1(x, 0, \alpha) = Proj_{Ker(M_3^1)}\tilde{f}_3^1(x, 0, \alpha) = Proj_S\tilde{f}_3^1(x, 0, 0) + O(|x|\alpha^2),$$

for $S := span\left\{ \begin{pmatrix} x_1^2x_2 \\ 0 \end{pmatrix}, \begin{pmatrix} 0 \\ x_1x_2^2 \end{pmatrix} \right\}$. For the present situation,

$$\begin{aligned} \frac{1}{2}f_2^1(x, y, \alpha) &= \Psi(0)[\alpha L_1(\Phi x + y) + \frac{1}{2}F_2(\Phi x + y, \alpha)], \\ \frac{1}{2}f_2^2(x, y, \alpha) &= (I - \pi)X_0[\alpha L_1(\Phi x + y) + \frac{1}{2}F_2(\Phi x + y, \alpha)], \\ \frac{1}{3!}f_3^1(x, y, \alpha) &= \Psi(0)\left[\frac{\alpha^2}{2}L_2(\Phi x + y) + \frac{1}{3!}F_3(\Phi x + y, \alpha)\right]. \end{aligned}$$

Since $F(0, \alpha) = 0, D_1F(0, \alpha) = 0$ for all $\alpha \in \mathbb{R}$, we write

$$\begin{aligned} F_2(\Phi x, \alpha) &= F_2(\Phi x, 0) = A_{(2,0)}x_1^2 + A_{(1,1)}x_1x_2 + A_{(0,2)}x_2^2 \\ F_3(\Phi x, 0) &= A_{(3,0)}x_1^3 + A_{(2,1)}x_1^2x_2 + A_{(1,2)}x_1x_2^2 + A_{(0,3)}x_2^3 \end{aligned}$$

where $A_{(q_2, q_1)} = \overline{A_{(q_1, q_2)}}$. Thus, the second order terms in (α, x) of the n.f. are given by

$$\frac{1}{2}g_2^1(x, 0, \alpha) = \begin{pmatrix} B_1x_1\alpha \\ B_1x_2\alpha \end{pmatrix},$$

with

$$B_1 = \psi_1(0)L_1(\varphi_1). \tag{3.9}$$

Now we determine the cubic terms for $\alpha = 0$. From (2.19), we have

$$g_3^1(x, 0, 0) = Proj_S f_3^1(x, 0, 0) + \frac{3}{2} Proj_S \left[(D_x f_2^1)(x, 0, 0) U_2^1(x, 0) + (D_y f_2^1)(x, 0, 0) U_2^2(x, 0) \right], \tag{3.10}$$

where

$$U_2^1(x, 0) = U_2^1(x, \alpha)|_{\alpha=0} = (M_2^1)^{-1} Proj_{Im(M_2^1)} f_2^1(x, 0, 0) = (M_2^1)^{-1} f_2^1(x, 0, 0)$$

and $U_2^2(x, 0) = U_2^2(x, \alpha)|_{\alpha=0}$ is determined by the equation

$$(M_2^2 U_2^2)(x, 0) = f_2^2(x, 0, 0).$$

The elements of the canonical basis for $V_2^3(\mathbb{C}^2)$ are

$$\begin{pmatrix} x_1^2 \\ 0 \end{pmatrix}, \begin{pmatrix} x_1 x_2 \\ 0 \end{pmatrix}, \begin{pmatrix} x_2^2 \\ 0 \end{pmatrix}, \begin{pmatrix} x_1 \alpha \\ 0 \end{pmatrix}, \begin{pmatrix} x_2 \alpha \\ 0 \end{pmatrix}, \begin{pmatrix} \alpha^2 \\ 0 \end{pmatrix}, \\ \begin{pmatrix} 0 \\ x_1^2 \end{pmatrix}, \begin{pmatrix} 0 \\ x_1 x_2 \end{pmatrix}, \begin{pmatrix} 0 \\ x_2^2 \end{pmatrix}, \begin{pmatrix} 0 \\ x_1 \alpha \end{pmatrix}, \begin{pmatrix} 0 \\ x_2 \alpha \end{pmatrix}, \begin{pmatrix} 0 \\ \alpha^2 \end{pmatrix},$$

with images under $\frac{1}{i\omega} M_2^1$ given respectively by

$$\begin{pmatrix} x_1^2 \\ 0 \end{pmatrix}, - \begin{pmatrix} x_1 x_2 \\ 0 \end{pmatrix}, -3 \begin{pmatrix} x_2^2 \\ 0 \end{pmatrix}, \begin{pmatrix} 0 \\ 0 \end{pmatrix}, -2 \begin{pmatrix} x_2 \alpha \\ 0 \end{pmatrix}, - \begin{pmatrix} \alpha^2 \\ 0 \end{pmatrix}, \\ 3 \begin{pmatrix} 0 \\ x_1^2 \end{pmatrix}, \begin{pmatrix} 0 \\ x_1 x_2 \end{pmatrix}, - \begin{pmatrix} 0 \\ x_2^2 \end{pmatrix}, 2 \begin{pmatrix} 0 \\ x_1 \alpha \end{pmatrix}, \begin{pmatrix} 0 \\ 0 \end{pmatrix}, \begin{pmatrix} 0 \\ \alpha^2 \end{pmatrix}.$$

Hence,

$$U_2^1(x, 0) = \frac{1}{i\omega} \left(\psi_1(0) (A_{(2,0)} x_1^2 - A_{(1,1)} x_1 x_2 - \frac{1}{3} A_{(0,2)} x_2^2) \right. \\ \left. \psi_2(0) (\frac{1}{3} A_{(2,0)} x_1^2 + A_{(1,1)} x_1 x_2 - A_{(0,2)} x_2^2) \right).$$

A few computations show that

$$Proj_S f_3^1(x, 0, 0) = \begin{pmatrix} \psi_1(0) A_{(2,1)} x_1^2 x_2 \\ \psi_2(0) A_{(1,2)} x_1 x_2^2 \end{pmatrix} \tag{3.11}$$

and

$$Proj_S [(D_x f_2^1)(x, 0, 0) U_2^1(x, 0)] = \begin{pmatrix} C_1 x_1^2 x_2 \\ C_1 x_1 x_2^2 \end{pmatrix}, \tag{3.12}$$

with

$$C_1 = \frac{i}{\omega} \left(\psi_1^2(0) A_{(2,0)} A_{(1,1)} - |\psi_1(0)|^2 (\frac{2}{3} |A_{(2,0)}|^2 + A_{(1,1)}^2) \right).$$

It remains to determine $Proj_S[(D_y f_2^1)(x, 0, 0)U_2^2(x, 0)]$. Let $H_2 : C \times C \rightarrow \mathbb{C}$ be the bilinear symmetric form such that

$$F_2(u, \alpha) = F_2(u, 0) = H_2(u, u), \quad u \in C$$

(i.e., $F_2(u, 0)$ is the quadratic form associated with $H_2(u, v)$). Then,

$$(D_y f_2^1)|_{y=0, \alpha=0}(h) = 2\Psi(0)H_2(\Phi x, h).$$

Define $h = h(x)(\theta)$ by $h(x) = U_2^2(x, 0)$, and write

$$h(x) = h_{20}x_1^2 + h_{11}x_1x_2 + h_{02}x_2^2,$$

where $h_{20}, h_{11}, h_{02} \in Q^1$. Using the definition of M_2^2, A_{Q^1} and π , we deduce that equation

$$(M_2^2 h)(x) = f_2^2(x, 0, 0)$$

is equivalent to

$$D_x h(x)Bx - A_{Q^1}(h(x)) = (I - \pi)X_0 F_2(\Phi x, 0),$$

or, in other words, to

$$\begin{cases} \dot{h}(x) - D_x h(x)Bx = \Phi\Psi(0)F_2(\Phi x, 0) \\ \dot{h}(x)(0) - L_0 h(x) = F_2(\Phi x, 0), \end{cases}$$

where we use the notation $\dot{h} = \frac{d}{d\theta}h$. From this system, we deduce $\overline{h_{02}} = h_{20}$, $\overline{h_{11}} = h_{11}$, and two initial value problems (IVPs),

$$\begin{cases} \dot{h}_{20} - 2i\omega h_{20} = A_{(2,0)}\Phi\Psi(0) \\ \dot{h}_{20}(0) - L_0(h_{20}) = A_{(2,0)} \end{cases}$$

and

$$\begin{cases} \dot{h}_{11} = A_{(1,1)}\Phi\Psi(0) \\ \dot{h}_{11}(0) - L_0(h_{11}) = A_{(1,1)}. \end{cases}$$

Thus, we obtain

$$Proj_S[(D_y f_2^1)h](x, 0, 0) = \begin{pmatrix} C_2 x_1^2 x_2 \\ \overline{C_2} x_1 x_2^2 \end{pmatrix}, \quad (3.13)$$

with

$$C_2 = 2\psi_1(0)[H_2(\varphi_1, h_{11}) + H_2(\varphi_2, h_{20})].$$

Hence, from (3.10)-(3.13) we get

$$\frac{1}{3!}g_3^1(x, 0, 0) = \left(\frac{B_2x_1^1x_2}{B_2x_1x_2^2} \right),$$

with

$$B_2 = \frac{1}{3!}\psi_1(0)A_{(2,1)} + \frac{1}{4}(C_1 + C_2). \tag{3.14}$$

Therefore, the n.f. reads as

$$\dot{x} = Bx + \left(\frac{B_1x_1\alpha}{B_1x_2\alpha} \right) + \left(\frac{B_2x_1^2x_2}{B_2x_1x_2^2} \right) + O(|x|\alpha^2 + |x|^4), \tag{3.15}$$

with B_1, B_2 given by (3.9), (3.14). Changing to real coordinates w , where $x_1 = w_1 - iw_2, x_2 = w_1 + iw_2$, and then to polar coordinates (ρ, ξ) , $w_1 = \rho \cos \xi, w_2 = \rho \sin \xi$, Eq. (3.15) becomes

$$\begin{cases} \dot{\rho} = K_1\alpha\rho + K_2\rho^3 + O(\alpha^2\rho + |(\rho, \alpha)|^4) \\ \dot{\xi} = -\omega + O(|(\rho, \alpha)|), \end{cases} \tag{3.16}$$

with the coefficients K_1, K_2 explicitly given in terms of the original FDE as $K_1 = Re B_1, K_2 = Re B_2$. Recall that the generic Hopf bifurcation corresponds to the situation $K_2 \neq 0$, the direction of the bifurcation is determined by the sign of K_1K_2 , and the stability of the nontrivial periodic orbits is determined by the sign of K_2 (see e.g. [30]). Solving the two IVPs above, we obtain

$$\begin{aligned} h_{20}(\theta) &= A_{(2,0)} \left(\frac{e^{2i\omega\theta}}{2i\omega - L_0(e^{2i\omega\theta})} - \frac{\psi_1(0)e^{i\omega\theta}}{i\omega} - \frac{\overline{\psi_1(0)}e^{-i\omega\theta}}{3i\omega} \right) \\ h_{11}(\theta) &= A_{(1,1)} \left(-\frac{1}{L_0(1)} + \frac{1}{i\omega} \left(\psi_1(0)e^{i\omega\theta} - \overline{\psi_1(0)}e^{-i\omega\theta} \right) \right). \end{aligned}$$

Theorem 3.3. A Hopf bifurcation occurs from $\alpha = 0$ on a 2-dimensional local centre manifold of the origin. On this manifold, the flow is given in polar coordinates by Eq. (3.16), with

$$K_1 = Re (\psi_1(0)L_1(e^{i\omega\theta})) \tag{3.17}$$

$$\begin{aligned} K_2 &= \frac{1}{3!}Re [\psi_1(0)A_{(2,1)}] - \frac{A_{(1,1)}}{2L_0(1)}Re [\psi_1(0)H_2(e^{i\omega\theta}, 1)] \\ &+ \frac{1}{2}Re \left[\frac{\psi_1(0)A_{(2,0)}}{2i\omega - L_0(e^{2i\omega\theta})}H_2(e^{-i\omega\theta}, e^{2i\omega\theta}) \right]. \end{aligned} \tag{3.18}$$

Example 3.4. Consider the well-known Wright equation

$$\dot{u}(t) = -au(t - 1)[1 + u(t)], \tag{3.19}$$

which has been studied by many authors (see [30, 45] and references therein). The characteristic equation for the linearization around zero, $\dot{u}(t) = -au(t - 1)$, is

$$\lambda + ae^{-\lambda} = 0. \tag{3.20}$$

There is a pair of (simple) imaginary roots $\pm i\omega$ for (3.20) if and only if $a = a_N$ and $\omega = \omega_N$, where

$$a_N = (-1)^N \omega_N, \quad \omega_N = \frac{\pi}{2} + N\pi, \quad N \in \mathbb{N}_0.$$

With $\alpha = a - a_N$, (3.19) is written as

$$\dot{u}(t) = -a_N u(t - 1) + \alpha u(t - 1) + F(u_t, \alpha), \tag{3.21}$$

where $F(v, \alpha) = -(a_N + \alpha)v(0)v(-1)$. Set $\Lambda = \{i\omega_N, -i\omega_N\}$. For $\psi(0)$ as in (3.8), $\psi_1(0) = \frac{1-i\omega_N}{1+\omega_N^2}$. Write the Taylor formulas

$$L(\alpha)v = L_0v + L_1(\alpha)v, \quad F(v, \alpha) = \frac{1}{2}F_2(v, \alpha) + \frac{1}{3!}F_3(v, \alpha),$$

where $L_0(v) = -a_N v(-1)$, $L_1(\alpha)v = -\alpha v(-1)$ and $\frac{1}{2}F_2(v, \alpha) = -a_N v(0)v(-1)$, $F_3(v, \alpha) = -\alpha v(0)v(-1)$. Applying Theorem 3.3, we obtain the n.f. on the center manifold of the origin near $a = a_N$ given in polar coordinates by Eq. (3.16), with

$$K_1 = \frac{a_N}{1 + a_N^2},$$

$$K_2 = \frac{\omega_N}{5(1 + a_N^2)} [(-1)^N - 3\omega_n] < 0, \quad \text{for } N \in \mathbb{N}_0.$$

Thus, a generic Hopf bifurcation for (3.19) occurs from $u = 0, a = a_N$. Since $K_2 < 0$ for all $N \in \mathbb{N}_0$, the bifurcating periodic orbits are always stable inside the centre manifold. On the other hand, $K_1 > 0$ if N even, thus $K_1 K_2 < 0$, and the Hopf bifurcation is supercritical. If N is odd, $K_1 < 0$, thus the Hopf bifurcation is subcritical. E.g., at the first bifurcating point $a = a_0 = \pi/2$ ($N = 0$), we have $\Lambda = \{i\pi/2, -i\pi/2\}$, and

$$K_1 = \frac{2\pi}{4 + \pi^2} > 0, \quad K_2 = \frac{\pi(2 - 3\pi)}{5(4 + \pi^2)} < 0. \tag{3.22}$$

4. Normal Forms for FDEs in Hilbert Spaces

In the following, X is a real or complex Hilbert space with inner product $\langle \cdot, \cdot \rangle$ and $C = C([-r, 0]; X)$ ($r > 0$) is the Banach space of continuous maps from $[-r, 0]$ to X with the sup norm. In order to simplify the notation, fix \mathbb{R} as the scalar field. Write $u_t \in C$ for $u_t(\theta) = u(t + \theta)$, $-r \leq \theta \leq 0$, and consider FDEs in X given in abstract form as

$$\dot{u}(t) = A_T u(t) + L(u_t) + F(u_t) \quad (t \geq 0), \tag{4.1}$$

where $A_T : D(A_T) \subset X \rightarrow X$ is a linear operator, $L \in \mathcal{L}(C; X)$, i.e., $L : C \rightarrow X$ is a bounded linear operator, and $F : C \rightarrow X$ is a C^k function ($k \geq 2$) such that $F(0) = 0, DF(0) = 0$.

We are particularly interested in equations (4.1), since they include reaction-diffusion (RD) equations with delays appearing in the reaction terms. Equations involving both time delays and spatial diffusion have been increasingly used in population dynamics, neural networks, disease modelling, and other fields.

A typical example of a RD-equation with delays is the so-called logistic equation with delays and spatial diffusion. In the framework of ODEs, consider the logistic equation $\dot{x} = ax(1 - bx)$, where a is the growth rate of the population and $K = 1/b$ the ‘‘carrying capacity’’. Taking into account the maturation period $r > 0$ of the population, the model becomes

$$\dot{x}(t) = ax(t)[1 - bx(t - r)],$$

known as the Hutchinson equation. Translating the positive equilibrium $1/b$ to the origin and effecting a scaling, $y(t) = bx(t) - 1$, we get the Wright equation (conf. Example 3.4)

$$\dot{y}(t) = -ay(t - r)[1 + y(t)].$$

Considering also a spatial variable $x \in [0, 1]$, and diffusion terms, we obtain the model

$$\frac{\partial v}{\partial t}(t, x) = d \frac{\partial^2 v}{\partial x^2} - av(t - r, x)[1 + v(t, x)], \quad t > 0, x \in (0, 1),$$

to which boundary conditions, such as Neumann or Dirichlet conditions, should be added. This RD-equation is often used as a model in population dynamics, where v stands for the density of the population spread over the interval $[0, 1]$, d is the diffusion rate that measures the internal migration of the population, and a, b, r have the same meaning as before.

4.1 Linear FDEs

For the linearized equation about the equilibrium zero

$$\dot{u}(t) = A_T u(t) + L(u_t), \quad (4.2)$$

we assume in this section the following hypotheses (see [73, 77, 101, 104]):

- (H1) A_T generates a C_0 -semigroup of linear operators $\{T(t)\}_{t \geq 0}$ on X ;
- (H2) $T(t)$ is a compact operator for $t > 0$;
- (H3) the eigenfunctions $\{\beta_k\}_{k=1}^\infty$ of A_T , with corresponding eigenvalues $\{\mu_k\}_{k=1}^\infty$, form an orthonormal basis for X ;
- (H4) the subspaces \mathcal{B}_k of C , $\mathcal{B}_k := \{\varphi \beta_k \mid \varphi \in C([-r, 0]; \mathbb{R})\}$, satisfy $L(\mathcal{B}_k) \subset \text{span}\{\beta_k\}$, $k \in \mathbb{N}$.

For a straightforward generalization of these assumptions to equations (4.2) in Banach spaces see [101, Chapter 3]. For a weaker version of (H4) see [36].

Hypothesis (H4) roughly requires that the operator L does not mix the spatial variations described by eigenvectors β_k of A_T . This condition is very restrictive in terms of applications, since it almost imposes that L is a scalar multiplication. In Section 5 of the present text, normal forms are developed for FDEs in Banach spaces without imposing (H3)-(H4). Nevertheless, the situation where (H1)-(H4) hold will be studied separately in this section since it provides a strong result: eventually under additional conditions, for (4.1) it is possible to associate an FDE in \mathbb{R}^n , whose n.f. on invariant manifolds coincide with n.f. on invariant manifolds for (4.1), up to some order. This allows us to apply to (4.1) the n.f. method for FDEs in \mathbb{R}^n described in Section 2 without further computations.

As for retarded FDEs in \mathbb{R}^n , we start by looking for solutions of the linear equation (4.2) of the exponential type,

$$u(t) = e^{\lambda t} y, \quad y \in D(A_T).$$

Clearly $u(t)$ as above is a non-trivial solution of (4.2) if and only if λ, y satisfy the *characteristic equation*

$$\Delta(\lambda)y = 0, \quad \lambda \in \mathbb{C}, \quad y \in D(A_T) \setminus \{0\}, \quad (4.3)$$

where the characteristic operator $\Delta(\lambda)$ is defined by

$$\Delta(\lambda) : D(A_T) \subset X \rightarrow X, \quad \Delta(\lambda)y = \lambda y - A_T y - L(e^{\lambda \cdot} y).$$

Let A be the infinitesimal generator associated with the semiflow of the linearized equation (4.2). It is well-known ([73, 77, 92, 101, 104]) that its eigenvalues are exactly the roots of the characteristic equation (4.3), that the spectrum of A is reduced to the point spectrum and that, for each $\alpha \in \mathbb{R}$, the set $\sigma(A) \cap \{\lambda \in \mathbb{C} : \text{Re } \lambda \geq \alpha\}$ is finite.

Since (H4) states that L does not mix the modes of eigenvalues of A_T , and from (H3) X can be decomposed by $\{\beta_k\}_{k=1}^\infty$, we deduce that equation $\Delta(\lambda)y = 0$ is equivalent to the sequence of characteristic equations

$$\lambda - \mu_k - L_k(e^{\lambda \cdot}) = 0 \quad (k \in \mathbb{N}), \tag{4.4_k}$$

where $L_k : C([-r, 0]; \mathbb{R}) \rightarrow \mathbb{R}$ are defined by $L_k(\psi)\beta_k = L(\psi\beta_k)$, for $k \in \mathbb{N}$.

Again, for the sake of applications, we fix $\Lambda = \{\lambda \in \sigma(A) : \text{Re } \lambda = 0\} \neq \emptyset$, and let P be the centre space for (4.2). Since Λ is a finite set, there exists $N \in \mathbb{N}$, such that $\Lambda = \{\lambda \in \mathbb{C} : \lambda \text{ is a solution of (4.4}_k\text{) with } \text{Re } \lambda = 0, \text{ for some } k \in \{1, \dots, N\}\}$.

We describe briefly an adjoint theory for FDEs (4.2) as in [73, 77], assuming the above hypotheses. The main idea is to relate the eigenvalues of the infinitesimal generator A (in this case, only the elements of Λ) with the eigenvalues of certain scalar FDEs. On \mathcal{B}_k , the linear equation $\dot{u}(t) = A_T u(t) + L(u_t)$ is equivalent to the FDE on \mathbb{R}

$$\dot{z}(t) = \mu_k z(t) + L_k z_t, \tag{4.5_k}$$

with characteristic equation given by (4.4_k), $k \in \mathbb{N}$. With this identification, the standard adjoint theory for retarded FDEs can be used to decompose C , in the following way. For $1 \leq k \leq N$, define $(\cdot, \cdot)_k$ as the adjoint bilinear form on $C([0, r]; \mathbb{R}^*) \times C([-r, 0]; \mathbb{R})$ associated with (4.5_k), and decompose $C([-r, 0]; \mathbb{R})$ by $\Lambda_k := \{\lambda \in \mathbb{C} : \lambda \text{ satisfies (4.4}_k\text{) and } \text{Re } \lambda = 0\}$ as in Section 2.1 (see [58]):

$$C([-r, 0]; \mathbb{R}) = P_k \oplus Q_k, \quad P_k = \text{span } \Phi_k, \quad P_k^* = \text{span } \Psi_k, \\ (\Psi_k, \Phi_k)_k = I, \quad \dim P_k = \dim P_k^* := m_k, \quad \dot{\Phi}_k = \Phi_k B_k,$$

where P_k is the centre space for (4.5_k) and B_k is an $m_k \times m_k$ constant matrix. For each $k \in \mathbb{N}$, the projection $P_k \oplus Q_k \rightarrow P_k, u \mapsto \Phi_k(\Psi_k, u)_k$ induces a projection

$$C \rightarrow P_k \beta_k, \quad \varphi \mapsto \Phi_k(\Psi_k, \langle \varphi(\cdot), \beta_k \rangle)_k \beta_k.$$

We use the above decompositions to decompose C by Λ :

$$C = P \oplus Q, \quad P = \text{Im } \pi, \quad Q = \text{Ker } \pi,$$

where $\dim P = \sum_{k=1}^N m_k := M$ and $\pi : C \rightarrow P$ is the canonical projection defined by

$$\pi\phi = \sum_{k=1}^N \Phi_k(\Psi_k, \langle \phi(\cdot), \beta_k \rangle) \beta_k .$$

4.2 Normal forms

As for retarded FDEs in \mathbb{R}^n , we first enlarge the phase space so that (4.1) can be written as an abstract ODE, along the lines of Section 2. Denote by X_0 the function defined by $X_0(0) = I$, $X_0(\theta) = 0$, $-r \leq \theta < 0$, where I is the identity operator on X , and let

$$BC \equiv C \times X = \{\phi + X_0\alpha : \phi \in C, \alpha \in X\}.$$

In BC , (4.1) reads as an abstract ODE,

$$\frac{d}{dt}v = \tilde{A}v + X_0F(v), \tag{4.6}$$

where \tilde{A} is the extension of the infinitesimal generator A defined by

$$\begin{aligned} \tilde{A} : C_0^1 \subset BC &\rightarrow BC \\ D(\tilde{A}) = C_0^1 &:= \{\phi \in C : \dot{\phi} \in C, \phi(0) \in D(A_T)\} \\ \tilde{A}\phi &= \dot{\phi} + X_0[L(\phi) + A_T\phi(0) - \dot{\phi}(0)]. \end{aligned}$$

We further consider the extension of the projection $\pi : C \rightarrow P$ to BC , still denoted by π , by defining

$$\pi(X_0\alpha) = \sum_{k=1}^N \Phi_k\Psi_k(0) \langle \alpha, \beta_k \rangle \beta_k, \quad \alpha \in X.$$

By using π , the enlarged space BC is decomposed by Λ as

$$BC = P \oplus \text{Ker } \pi,$$

with $Q \subset \text{Ker } \pi$ and $P \subset C_0^1$. One can prove that π is continuous and commutes with \tilde{A} in C_0^1 . For $v \in C_0^1$, using the above decomposition, we write

$$v(t) = \sum_{k=1}^N \Phi_k x_k(t) + y(t), \quad \text{with } x_k(t) \in \mathbb{R}, 1 \leq k \leq N, y \in C_0^1 \cap \text{Ker } \pi := Q^1.$$

Hence, Eq. (4.6) is decomposed as a system of abstract ODEs on $\mathbb{R}^M \times \text{Ker } \pi$, with linear and nonlinear parts separated and with finite and infinite dimensional variables also separated in the linear term:

$$\begin{aligned} \dot{x}_k &= B_k x_k + \Psi_k(0) < F\left(\sum_{p=1}^N \Phi_p x_p \beta_p + y\right), \beta_k > \beta_k, \quad k = 1, \dots, N, \\ \frac{d}{dt} y &= A_{Q^1} y + (I - \pi) X_0 F\left(\sum_{p=1}^N \Phi_p x_p \beta_p + y\right), \end{aligned}$$

where A_{Q^1} is the restriction of \tilde{A} to Q^1 , $A_{Q^1} : Q^1 \subset \text{Ker } \pi \rightarrow \text{Ker } \pi$. Defining $B = \text{diag}(B_1, \dots, B_N)$, $\Phi = \text{diag}(\Phi_1, \dots, \Phi_N)$ and $\Psi = \text{diag}(\Psi_1, \dots, \Psi_N)$, the above system is written in a simpler form as

$$\begin{aligned} \dot{x} &= Bx + \Psi(0) \left(< F\left((\Phi x)^\top \begin{pmatrix} \beta_1 \\ \vdots \\ \beta_N \end{pmatrix} + y\right), \beta_k > \right)_{k=1}^N \\ \frac{d}{dt} y &= A_{Q^1} y + (I - \pi) X_0 F\left((\Phi x)^\top \begin{pmatrix} \beta_1 \\ \vdots \\ \beta_N \end{pmatrix} + y\right), \quad x = (x_1, \dots, x_N) \in \mathbb{R}^M, y \in Q^1. \end{aligned} \tag{4.7}$$

Recall that the existence of a local centre manifold for (4.1) tangent to P at zero was proven under (H1)-(H4) in [73], following the approach in [77].

For (4.1) written in the form (4.7), it is possible to develop a normal form theory for FDEs in X based on the theory in Section 2. Formally, the operators M_j^1, M_j^2 associated with the sequence of changes of variables are still given by (2.13), but now A_{Q^1} and π are as defined above in this subsection. On the other hand, writing the Taylor expansion for F ,

$$F(v) = \sum_{j \geq 2} \frac{1}{j!} F_j(v) \quad , \quad v \in C,$$

where F_j is the j th Fréchet derivative of F , (4.7) reads as

$$\begin{cases} \dot{x} = Bx + \sum_{j \geq 2} \frac{1}{j!} f_j^1(x, y) \\ \dot{y} = A_{Q^1} y + \sum_{j \geq 2} \frac{1}{j!} f_j^2(x, y) \end{cases},$$

with the terms $f_j^i(x, y), i = 1, 2, j \geq 2$, given here by

$$f_j^1(x, y) = \Psi(0) \left(\left\langle F_j \left((\Phi x)^\top \begin{pmatrix} \beta_1 \\ \vdots \\ \beta_N \end{pmatrix} + y \right), \beta_k \right\rangle \right)_{k=1}^N$$

$$f_j^2(x, y) = (I - \pi) X_0 F_j \left((\Phi x)^\top \begin{pmatrix} \beta_1 \\ \vdots \\ \beta_N \end{pmatrix} + y \right), \quad x \in \mathbb{R}^M, y \in Q^1.$$

The main results in Section 2 are still valid in this setting. Details and examples of applications can be found in [37].

4.3 The associated FDE on \mathbb{R}^N

If we compare Eq. (4.7) with Eq. (2.6), it is natural to associate an FDE in \mathbb{R}^N with the original FDE (4.1). In fact, formally we relate (4.7) with the DDE in \mathbb{R}^N

$$\begin{cases} \dot{x} = Bx + \Psi(0)G(\Phi x + y) \\ \dot{y} = A_{Q^1}y + (I - \pi)X_0G(\Phi x + y), \end{cases} \tag{4.8}$$

for the nonlinearity $G : C_N := C([-r, 0]; \mathbb{R}^N) \rightarrow \mathbb{R}^N$ defined by

$$G(\phi) = \left(\left\langle F_j \left(\phi^\top \begin{pmatrix} \beta_1 \\ \vdots \\ \beta_N \end{pmatrix} \right), \beta_k \right\rangle \right)_{k=1}^N. \tag{4.9}$$

However, the operators \tilde{A} and π are defined differently in (4.7) and (4.8). On the other hand, in order to derive the linear terms in (4.8) from the procedure in Section 2.2, the linearization of the original FDE in \mathbb{R}^N (2.1) should have the form $\dot{u}(t) = R(u_t)$, with $R \in \mathcal{L}(C_N; \mathbb{R}^N)$ defined by

$$R(\phi) = (\mu_k \phi_k(0) + L_k(\phi_k))_{k=1}^N, \tag{4.10}$$

for $\phi = (\phi_1, \dots, \phi_N) \in C([-r, 0]; \mathbb{R}^N)$ (cf. (4.5_k), $k = 1, \dots, N$).

Definition 4.1. The following FDE in $C_N := C([-r, 0]; \mathbb{R}^N)$ is said to be the **FDE in \mathbb{R}^N associated with** Eq. (4.1) **by Λ at zero:**

$$\dot{x}(t) = R(x_t) + G(x_t), \tag{4.11}$$

where $x(t) = (x_k(t))_{k=1}^N, x_t = (x_{t,k})_{k=1}^N$, and G, R are defined by (4.9), (4.10).

The relevance of this associated FDE in \mathbb{R}^N is summarized in the next theorem.

Theorem 4.2. [37] Consider Eq. (4.1), and assume (H1)-(H4).

(i) if F is of class C^2 , then, for a suitable change of variables, the n.f. on the centre manifold for both (4.1) and (4.11) is the same, up to second order terms;

(ii) if F is of class C^3 , $F(v) = \frac{1}{2!}F_2(v) + \frac{1}{3!}F_3(v) + o(|v|^3)$, and

$$Proj_{span\{\beta_1, \dots, \beta_N\}} DF_2(u)(\phi\beta_j) = 0, \text{ for } j \geq N+1, u \in P, \phi \in C([-r, 0]; \mathbb{R}), \text{ (H5)}$$

then, for a suitable change of variables, the n.f. on the centre manifold for both (4.1) and (4.11) are the same, up to third order terms.

Note that assumption (H5) can also be written as

$$\langle DF_2(u)(\phi\beta_j), \beta_p \rangle = 0, \text{ for } 1 \leq p \leq N, j > N \text{ and all } u \in P, \phi \in C([-r, 0]; \mathbb{R}).$$

The proof of this theorem is based on the possibility of identifying the operators M_j^1, M_j^2 of the n.f. algorithm for (4.1) with the corresponding operators appearing in the computation of n.f. relative to Λ for (4.11). The above result is not completely surprising. In fact, note that (H4) can be interpreted as nonresonance conditions of first order, in the sense that it imposes nonresonances inside the linear part of the equation, between L and the operator A_T . Now recall that second order terms of n.f. are computed by looking at second order terms in the equation for $x \in \mathbb{R}^N$. The cubic terms of n.f. are obtained by using not only second and third order terms in the equation for $x \in \mathbb{R}^N$, but also second order terms in the equation for $y \in \text{Ker } \pi$. Therefore, it is not surprising to expect the quadratic terms in the n.f. for the flow on the centre manifold for both equations (4.1) and (4.11) to be the same. On the other hand, it is natural to expect that additional nonresonance conditions of second order should be imposed, in order to derive the same result for cubic terms. The role of (H5) is to impose such nonresonance conditions, between the second order terms of F and the eigenspaces for A_T . Of course, we could derive other nonresonance conditions between the j -order terms ($j \leq k - 1$) of F and the eigenspaces for A_T , in order to conclude that the n.f. on the centre manifold for both (4.1) and (4.11) are the same up to k order terms. In the present framework, Theorem 4.2 is particularly relevant, since it enables us to reduce the computation of n.f. for FDEs in Hilbert spaces X to the computation of n.f. for FDEs in finite dimensional spaces. Moreover, even if (H5) fails, one can prove

[37] that the associated FDE by Λ (4.11) still carries much information that can be used when computing n.f. for (4.1).

4.4 Applications to bifurcation problems

Population dynamics models involving memory and diffusion in one spatial variable are often given by equations of the form

$$\begin{aligned} \frac{\partial u(t, x)}{\partial t} &= d \frac{\partial^2 u(t, x)}{\partial x^2} + a(x)u(t, x) + b(x)u(t - r, x) \\ &\quad + c_0(x)u(t, x)u(t - r, x), \quad t > 0, \quad x \in (\ell_1, \ell_2), \end{aligned}$$

with either Neumann or Dirichlet boundary conditions on $[\ell_1, \ell_2] \subset \mathbb{R}$, and initial condition

$$u_0 = \varphi \in C = C([-r, 0]; X).$$

For the choice e.g. $X = L^2[\ell_1, \ell_2]$, the problem is not well-posed, since $L^2[\ell_1, \ell_2]$ is not a Banach algebra. However, the question of *existence* of solutions will not be addressed here, since that is not the aim of the n.f. theory. In order to guarantee existence of solutions, there are several approaches. One can restrict the state space to an appropriate space of functions invariant under products, e.g. $X = C[\ell_1, \ell_2]$ or $X = W^{2,2}[\ell_1, \ell_2]$ [73, 77, 101]. Another possibility is to consider a fractional power $(A_T)^\beta$ of A_T ($0 < \beta < 1$), and take as the Banach state space the fractional power space $X_\beta = D(A^\beta)$, with norm $\|v\|_\beta = \|(A_T)^\beta v\|$; and $C_\beta = C([-1, 0]; X_\beta)$ as the phase space. This theory is well established since the work of Henry [63]. See also [46, 54, 93, 94]. Another procedure is to consider $X = L^2[\ell_1, \ell_2]$, and restrict the space of initial conditions that are chosen in a natural “initial-history” space [85, 86].

As an application, we shall consider the Wright equation with diffusion. For an application of the n.f. theory to a 2-dimensional RD-equation with two delays, see [40].

Example 4.3. Consider the Wright equation with diffusion and Neumann conditions ([37, 73, 77, 104]):

$$\begin{aligned} \frac{\partial u(t, x)}{\partial t} &= d \frac{\partial^2 u(t, x)}{\partial x^2} - au(t - 1, x)[1 + u(t, x)], \quad t > 0, \quad x \in (0, \pi) \\ \frac{\partial u(t, 0)}{\partial x} &= \frac{\partial u(t, \pi)}{\partial x} = 0, \quad t \geq 0, \end{aligned} \tag{4.12}$$

where $d > 0, a > 0$. Let $X = W^{2,2}(0, \pi)$ and $C = C([-1, 0]; X)$. In abstract form in C , (4.12) is given by

$$\frac{d}{dt}u(t) = d\Delta u(t) + L(a)(u_t) + f(u_t, a) \tag{4.13}$$

where $\Delta = \frac{\partial^2}{\partial x^2}$, $D(\Delta) = \{v \in W^{2,2}(0, \pi) : \frac{dv}{dx} = 0 \text{ at } x = 0, \pi\}$ and $L(a)(v) = -av(-1)$, $f(v, a) = -av(0)v(-1)$.

The eigenvalues of $A_T = d\Delta$ are $\mu_k = -dk^2, k \geq 0$, with corresponding normalized eigenfunctions $\beta_k(x) = \frac{\cos(kx)}{\|\cos(kx)\|_{2,2}}$. One can easily check that (H1)-(H4) hold. For the linearization of (4.13) about the equilibrium $u = 0$, the characteristic equation is equivalent to the sequence of characteristic equations

$$\lambda + ae^{-\lambda} + dk^2 = 0, (k = 0, 1, \dots). \tag{4.14_k}$$

Yoshida [104] showed that for $a < \pi/2$, all roots have negative real parts, thus the zero solution is asymptotically stable; for $a = \pi/2$ and $k = 0$, there exists a unique pair of characteristic values on the imaginary axis, $\pm i\pi/2$, that are simple roots, and that all the other characteristic values of (4.14_k), $k \in \mathbb{N}_0$, have negative real parts. At the critical point $a = \pi/2$, rescale the parameter by setting $a = \pi/2 + \alpha$. Since the Hopf condition holds [104], i.e., there is a pair of eigenvalues crossing transversely the imaginary axis at $\alpha = 0$, a Hopf bifurcation occurs on a 2-dimensional centre manifold.

Let $\Lambda = \{i\pi/2, -i\pi/2\}$. With the above notations (except that here $k \in \mathbb{N}_0$ instead of $k \in \mathbb{N}$), $N = 0, \mu_0 = 0, \beta_0 = \frac{1}{\sqrt{\pi}}$. Since $L(\psi\beta_0) = -\frac{\pi}{2}\psi(-1)\beta_0$, the operator $L_0 : C([-1, 0]; \mathbb{R}) \rightarrow \mathbb{R}$ in (4.40), corresponding to the eigenvalue $\mu_0 = 0$, is defined by

$$L_0(\psi) = -\frac{\pi}{2}\psi(-1).$$

The associated FDE (on \mathbb{R}) by Λ at the equilibrium point $u = 0, \alpha = 0$ is

$$\dot{x}(t) = L_0(x_t) + \langle F(x_t\beta_0, \alpha), \beta_0 \rangle, \tag{4.15}$$

where $F(v, \alpha) = -\alpha v(-1) - (\frac{\pi}{2} + \alpha)v(0)v(-1)$. We have

$$\begin{aligned} \langle F(x_t\beta_0, \alpha), \beta_0 \rangle &= -\langle \alpha x(t-1) \frac{1}{\sqrt{\pi}} + (\frac{\pi}{2} + \alpha)x(t) \frac{1}{\sqrt{\pi}}x(t-1) \frac{1}{\sqrt{\pi}}, \frac{1}{\sqrt{\pi}} \rangle \\ &= -x(t-1)[\alpha + (\frac{\pi}{2} + \alpha) \frac{1}{\sqrt{\pi}}x(t)] \end{aligned}$$

Thus, (4.15) becomes

$$\dot{x}(t) = -(\frac{\pi}{2} + \alpha)x(t-1)[1 + \frac{1}{\sqrt{\pi}}x(t)], \tag{4.16}$$

i.e., (4.16) is the Wright equation (3.19) for the scaling $x \mapsto \frac{1}{\sqrt{\pi}}x$.

We prove now that hypothesis (H5) is satisfied. He have

$$F_2(v, \alpha) = -\alpha v(-1) - \frac{\pi}{2}v(0)v(-1), \quad v \in C, \alpha \in \mathbb{R}.$$

For $u \in P$, write $u = \Phi_0 c \beta_0$, where $c \in \mathbb{C}^2$ and Φ_0 is a basis for the centre space P_0 for the linear FDE in \mathbb{R} (4.50), i.e., $\dot{x}(t) = L_0(x_t)$. Then,

$$\begin{aligned} \frac{1}{2} &< D_1 F_2(u, \alpha)(\psi \beta_k), \beta_0 > \\ &= -\alpha < \psi(-1)\beta_k, \beta_0 > - \frac{\pi}{2} < (u(0)\psi(-1) + u(-1)\psi(0))\beta_k, \beta_0 > \\ &= - \left[\alpha \psi(-1) + \frac{\sqrt{\pi}}{2} (\Phi_0(0)c\psi(-1) + \Psi_0(-1)c\psi(0)) \right] < \beta_k, \beta_0 > = 0, \end{aligned}$$

for all $k \geq 1, c \in \mathbb{C}^2, \psi \in C([-1, 0]; \mathbb{R})$. This implies (H5).

For (3.19), the n.f. on the centre manifold is given in polar coordinates (ρ, ξ) by (3.16), where K_1, K_2 are given by (3.22). Effecting the scaling $x \mapsto \frac{1}{\sqrt{\pi}}x$, from Theorem 4.2 we deduce the n.f. on the centre manifold for (4.12) without further computations:

$$\begin{aligned} \dot{\rho} &= K_1 \alpha \rho + \frac{1}{\pi} K_2 \rho^3 + O(\alpha^2 \rho + |(\rho, \alpha)|^4) \\ \dot{\xi} &= -\frac{\pi}{2} + O(|(\rho, \alpha)|), \end{aligned}$$

with K_1, K_2 as in (3.22). Thus, a generic supercritical Hopf bifurcation occurs on the centre manifold for (4.12), with stable nontrivial bifurcating periodic solutions.

5. Normal Forms for FDEs in General Banach Spaces

Consider again a semilinear FDE (4.1) in the phase space $C := C([-r, 0]; X)$,

$$\dot{u}(t) = A_T u(t) + L(u_t) + F(u_t), \tag{5.1}$$

where now X is a general Banach space, $A_T : D(A_T) \subset X \rightarrow X$ is linear, and $F : C \rightarrow X$ is C^k ($k \geq 2$) with $F(0) = 0, DF(0) = 0$.

Before developing a normal form theory on an invariant manifold for FDEs (5.1), it is necessary to establish two necessary technical tools: a formal adjoint theory for linear equations, and the existence and smoothness of centre manifolds for nonlinearly perturbed equations (5.1) ([43]).

5.1 Adjoint theory

Consider a linear FDE in C of the form

$$\dot{u}(t) = A_T u(t) + L(u_t), \tag{5.2}$$

where A_T, L are as in (5.1). In this section, we shall assume only the following hypotheses:

- (H1) A_T generates a C_0 semigroup of linear operators $\{T(t)\}_{t \geq 0}$ on X ;
- (H2) $T(t)$ is a compact operator for $t > 0$;
- (H3) there exists a function $\eta : [-r, 0] \rightarrow \mathcal{L}(X, X)$ of bounded variation such that

$$L(\varphi) = \int_{-r}^0 d\eta(\theta)\varphi(\theta), \quad \varphi \in C.$$

Under (H1)-(H3), a complete formal adjoint theory was developed in [43], and will be presented here, following some ideas in [16] and [92]. The adjoint theory for abstract FDEs was initiated in [92]. However, the theory in [92] was quite incomplete and more hypotheses were assumed. On the other hand, Arino and Sanchez [16] developed a complete formal adjoint theory for equations $\dot{u}(t) = L(u_t)$. From the point of view of the applications we have in mind, equations in the form (5.1) are more interesting, since they include RD-equations with delays. In [16], the authors worked only with characteristic values that are not in the essential spectrum in order to obtain Fredholm operators, whereas in our setting we will be dealing with compact operators. Note that, contrary to the situation studied in Section 4, we are not imposing any conditions which relate L with the eigenvalues for A_T .

Consider the characteristic equation (4.3) for (5.2),

$$\Delta(\lambda)x = 0, \quad x \in D(A_T) \setminus \{0\} \tag{5.3}$$

where the characteristic operator $\Delta(\lambda) : D(A_T) \subset X \rightarrow X$ is defined by

$$\Delta(\lambda)x = A_T x + L(e^{\lambda \cdot} x) - \lambda x.$$

We start by recalling the results in [92]. Consider the C_0 -semigroup of linear operators $\{U(t)\}_{t \geq 0}$, defined by the mild solutions of (5.2) with initial condition $\varphi \in C$, $U(t) : C \rightarrow C, U(t)\varphi = u_t(\varphi)$, and its infinitesimal generator A ,

$$A\varphi = \dot{\varphi}, \quad D(A) = \{\varphi \in C : \dot{\varphi} \in C, \varphi(0) \in D(A_T), \dot{\varphi}(0) = A_T \varphi(0) + L(\varphi)\}.$$

Travis and Webb [92] proved that $U(t)$ is a compact operator for each $t > r$ and $\sigma(A) = \sigma_P(A)$. From general results on C_0 -semigroups and compact operators (see e.g. [84]), it follows that, for $\lambda \in \sigma(A)$,

$$C = Ker [(A - \lambda I)^m] \oplus Im [(A - \lambda I)^m], \tag{5.4}$$

where $Im [(A - \lambda I)^m]$ is a closed subspace of C and $Ker [(A - \lambda I)^m]$ is the generalized eigenspace for A associated with λ , denoted as usual by $\mathcal{M}_\lambda(A)$, with $\mathcal{M}_\lambda(A)$ finite dimensional. In particular, the ascent and descent of $A - \lambda I$ are both equal to m , where m is the order of λ as a pole of the resolvent $R(\lambda; A)$ [90]. Our purpose now is to write $Im [(A - \lambda I)^m]$ in terms of a (formal) adjoint theory, in the sense that a Fredholm alternative result should be established.

As seen in Section 4.1, λ is a characteristic value if and only if λ is an eigenvalue of A , and, in this case, there is $x \in D(A_T) \setminus \{0\}$ such that $u(t) = e^{\lambda t}x$ is a solution of (5.2). Thus,

$$Ker (A - \lambda I) = \{e^{\lambda t}x : x \in Ker \Delta(\lambda)\}. \tag{5.5}$$

We use the formal duality $\langle\langle \cdot, \cdot \rangle\rangle$ in $C^* \times C$ introduced in [92] as the bilinear form

$$\langle\langle \alpha, \varphi \rangle\rangle = \langle \alpha(0), \varphi(0) \rangle - \int_{-r}^0 \int_0^\theta \langle \alpha(\xi - \theta), d\eta(\theta)\varphi(\xi) \rangle d\xi$$

where $C^* := C([0, r]; X^*)$, X^* is the dual of X , and $\langle \cdot, \cdot \rangle$ is the usual duality in $X^* \times X$. Define the formal adjoint equation to (5.2) as

$$\dot{\alpha}(t) = -A_T^* \alpha(t) - L^*(\alpha^t), \quad t \leq 0, \tag{5.6}$$

where $\alpha^t \in C^*$, $\alpha^t(s) = \alpha(t + s)$ for $s \in [0, r]$, A_T^* is the adjoint operator for A_T , $L^* : C^* \rightarrow X^*$ is given by $L^*(\alpha) = \int_{-r}^0 d\eta^*(\theta)\alpha(-\theta)$, and $\eta^*(\theta)$ is the adjoint for $\eta(\theta)$, $\eta^* : [-r, 0] \rightarrow \mathcal{L}(X^*, X^*)$. Let A^* be the infinitesimal generator associated with the flow for (5.6). The operator A^* is called the formal adjoint of A , since

$$\langle\langle A^* \alpha, \varphi \rangle\rangle = \langle\langle \alpha, A\varphi \rangle\rangle, \quad \text{for } \alpha \in D(A^*), \varphi \in D(A).$$

Inspired by the work of Hale [58, Chapter 7] and [16], we now introduce some auxiliary operators, that will be used first of all to get an explicit characterization of the null spaces and ranges for the operators $(A - \lambda I)^m$ and $(A^* - \lambda I)^m$. Let $\lambda \in \mathbb{C}$, $j \in \mathbb{N}_0$, $m \in \mathbb{N}$, and define the operators

$$L_\lambda^j : X \rightarrow X, \quad L_\lambda^j(x) = L\left(\frac{\theta^j}{j!} e^{\lambda\theta} x\right),$$

$$\mathcal{L}_\lambda^{(m)} : X^m \rightarrow X^m, \mathcal{L}_\lambda^{(m)} = \begin{pmatrix} \Delta(\lambda) & L_\lambda^1 - I & L_\lambda^2 & \dots & L_\lambda^{m-1} \\ 0 & \Delta(\lambda) & L_\lambda^1 - I & \dots & L_\lambda^{m-2} \\ \vdots & \vdots & \ddots & \ddots & \vdots \\ 0 & 0 & \dots & \Delta(\lambda) & L_\lambda^1 - I \\ 0 & 0 & \dots & 0 & \Delta(\lambda) \end{pmatrix}$$

and

$$\mathcal{R}_\lambda^{(m)} : C \rightarrow X^m, \mathcal{R}_\lambda^{(m)}(\psi) = \begin{pmatrix} -L \left(\int_0^\theta e^{\lambda(\theta-\xi)} \frac{(\theta-\xi)^{m-1}}{(m-1)!} \psi(\xi) d\xi \right) \\ \vdots \\ -L \left(\int_0^\theta e^{\lambda(\theta-\xi)} (\theta-\xi) \psi(\xi) d\xi \right) \\ \psi(0) - L \left(\int_0^\theta e^{\lambda(\theta-\xi)} \psi(\xi) d\xi \right). \end{pmatrix}$$

Theorem 5.1. Let $\lambda \in \mathbb{C}, m \in \mathbb{N}$. Then:

(i) $Ker [(A - \lambda I)^m] = \left\{ \sum_{j=0}^{m-1} \frac{\theta^j}{j!} e^{\lambda\theta} u_j, \theta \in [-r, 0], \text{ with } \begin{pmatrix} u_0 \\ \vdots \\ u_{m-1} \end{pmatrix} \in \right.$

$Ker (\mathcal{L}_\lambda^{(m)}) \left. \right\};$

(ii) $\psi \in Im [(A - \lambda I)^m]$ iff $\mathcal{R}_\lambda^{(m)}(\psi) \in Im (\mathcal{L}_\lambda^{(m)})$;

(iii) $Ker [(A^* - \lambda I)^m] = \left\{ \sum_{j=0}^{m-1} \frac{(-s)^j}{j!} e^{-\lambda s} x_{m-j-1}^*, s \in [0, r], \text{ with } \right.$

$\begin{pmatrix} x_0^* \\ \dots \\ x_{m-1}^* \end{pmatrix} \in Ker ((\mathcal{L}_\lambda^{(m)})^*) \left. \right\}.$

The proof of this theorem follows from direct computations, so it is omitted. See [16, 58] for similar proofs.

We now establish some preliminary lemmas.

Lemma 5.2. The characteristic operator $\Delta(\lambda)$ generates a compact C_0 -semigroup of linear operators on X . Moreover, $\lambda \in \sigma(A)$ if and only if $0 \in \sigma(\Delta(\lambda))$.

Proof. From (5.4), clearly $\lambda \in \rho(A)$ if and only if 0 is not an eigenvalue of $\Delta(\lambda)$. On the other hand, $\Delta(\lambda)$ is the sum of A_T , which generates a compact C_0 -semigroup, with the bounded linear operator $L_\lambda^0 - \lambda I$. Hence, $\Delta(\lambda)$ generates a compact semigroup of linear operators on X [84, p. 79]. This also implies that $0 \in \rho(\Delta(\lambda))$ iff $0 \notin \sigma_P(\Delta(\lambda))$. Hence $\lambda \in \rho(A)$ iff $0 \in \rho(\Delta(\lambda))$. ■

Lemma 5.3. Let $\lambda \in \mathbb{C}$ and $m \in \mathbb{N}$. Then:

(i) if $\mu \in \rho(\Delta(\lambda))$, then $\mu \in \rho(\mathcal{L}_\lambda^{(m)})$ and $(\mathcal{L}_\lambda^{(m)} - \mu I)^{-1}$ is a compact operator;

(ii) $Im(\mathcal{L}_\lambda^{(m)})$ is a closed subspace of X^m .

Proof. Let $\mu \in \rho(\Delta(\lambda))$. For $m = 1$, we have $\mathcal{L}_\lambda^{(1)} = \Delta(\lambda)$, and from Lemma 5.2 we conclude that this operator generates a compact C_0 -semigroup. Thus, its resolvent $R(\Delta(\lambda); \mu) = [\Delta(\lambda) - \mu I]^{-1}$ is a compact operator. The rest of the proof of (i) follows by induction. For the proof of (ii), we use (i) and general spectral properties of compact operators. See [43] for details. ■

Lemma 5.4. Let $\lambda \in \mathbb{C}, m \in \mathbb{N}$. Then,

$$dim Ker(\mathcal{L}_\lambda^{(m)}) = dim Ker((\mathcal{L}_\lambda^{(m)})^*) \tag{5.7}$$

Proof. Let $\lambda \in \sigma(A)$. From Lemma 5.2, $0 \in \sigma(\Delta(\lambda))$. Fix any $\mu \in \rho(\Delta(\lambda))$. From Lemma 5.3 we deduce that $\mu \in \rho(\mathcal{L}_\lambda^{(m)})$. One can prove that

$$\begin{aligned} Ker(\mathcal{L}_\lambda^{(m)}) &= Ker((\mathcal{L}_\lambda^{(m)} - \mu I)^{-1} + \frac{I}{\mu}), \\ Ker((\mathcal{L}_\lambda^{(m)})^*) &= Ker([\mathcal{L}_\lambda^{(m)*} - \mu I]^{-1} + \frac{I}{\mu}). \end{aligned} \tag{5.8}$$

where $[\mathcal{L}_\lambda^{(m)*} - \mu I]^{-1} = [(\mathcal{L}_\lambda^{(m)} - \mu I)^{-1}]^*$. Also from Lemma 5.3, we have that $(\mathcal{L}_\lambda^{(m)} - \mu I)^{-1}$ is a compact operator, and from Schauder’s theorem we conclude that its adjoint $[(\mathcal{L}_\lambda^{(m)} - \mu I)^{-1}]^*$ is also a compact operator. In particular,

$$dim Ker((\mathcal{L}_\lambda^{(m)} - \mu I)^{-1} + \frac{I}{\mu}) = dim Ker([\mathcal{L}_\lambda^{(m)*} - \mu I]^{-1} + \frac{I}{\mu}). \tag{5.9}$$

From (5.8) and (5.9), we obtain (5.7). ■

As an immediate consequence of Theorem 5.1 and Lemma 5.4, we can now state the following:

Theorem 5.5. Let $\lambda \in \mathbb{C}, m \in \mathbb{N}$. Then,

$$dim Ker[(A - \lambda I)^m] = dim Ker[(A^* - \lambda I)^m].$$

In particular, $\sigma_P(A) = \sigma_P(A^*)$, and for $\lambda \in \sigma_P(A)$,

$$dim \mathcal{M}_\lambda(A) = dim \mathcal{M}_\lambda(A^*),$$

and the ascents of both operators $A - \lambda I$ and $A^* - \lambda I$ are equal. That is, if $\mathcal{M}_\lambda(A) = Ker[(A - \lambda I)^m]$, then $\mathcal{M}_\lambda(A^*) = Ker[(A^* - \lambda I)^m]$.

We are now in the position to state a “Fredholm alternative” result.

Theorem 5.6. Let $\lambda \in \sigma(A)$, $m \in \mathbb{N}$. Then $\psi \in Im [(A - \lambda I)^m]$ if and only if

$$\langle \langle \alpha, \psi \rangle \rangle = 0 \quad \text{for all } \alpha \in Ker [(A^* - \lambda I)^m].$$

Proof. From Lemma 5.3, the ranges of $\mathcal{L}_\lambda^{(m)}$ are closed subspaces, hence they coincide with the annihilator of the adjoint operator $(\mathcal{L}_\lambda^{(m)})^*$,

$$Im (\mathcal{L}_\lambda^{(m)}) = Ker ((\mathcal{L}_\lambda^{(m)})^*)^\perp.$$

From Theorem 5.1, $\psi \in Im [(A - \lambda I)^m]$ iff $\mathcal{R}_\lambda^{(m)}(\psi) \in Im (\mathcal{L}_\lambda^{(m)})$, thus $\psi \in Im [(A - \lambda I)^m]$ iff

$$\langle Y^*, \mathcal{R}_\lambda^{(m)}(\psi) \rangle = 0 \quad \text{for all } Y^* \in Ker ((\mathcal{L}_\lambda^{(m)})^*).$$

By using the formal duality, for $Y^* = (y_0^*, \dots, y_{m-1}^*)^T \in (X^*)^m$ one proves that

$$\begin{aligned} & \langle Y^*, \mathcal{R}_\lambda^{(m)}(\psi) \rangle \\ &= - \sum_{j=0}^{m-1} \langle y_j^*, L \left(\int_0^\theta e^{\lambda(\theta-\xi)} \frac{(\theta-\xi)^{m-j-1}}{(m-j-1)!} \psi(\xi) d\xi \right) \rangle + \langle y_{m-1}^*, \psi(0) \rangle \\ &= \sum_{j=0}^{m-1} \langle \langle e^{-\lambda s} \frac{(-s)^{m-j-1}}{(m-j-1)!} y_j^*, \psi \rangle \rangle. \end{aligned}$$

Using again Theorem 5.1, we deduce that $\alpha \in Ker [(A^* - \lambda I)^m]$ if and only if

$$\alpha = \sum_{j=0}^{m-1} e^{-\lambda s} \frac{(-s)^{m-j-1}}{(m-j-1)!} y_j^*,$$

with $Y^* = (y_0^*, \dots, y_{m-1}^*)^T \in Ker ((\mathcal{L}_\lambda^{(m)})^*)$. The above arguments imply that $\psi \in Ker [(A - \lambda I)^m]$ if and only if $\langle \langle \alpha, \psi \rangle \rangle = 0$ for all $\alpha \in Ker [(A^* - \lambda I)^m]$. ■

From the Fredholm alternative result in Theorem 5.6, we denote $Im [(A - \lambda I)^m] = Ker [(A^* - \lambda I)^m]^\perp$, where the orthogonality “ \perp ” is relative to the formal duality $\langle \langle \cdot, \cdot \rangle \rangle$. For the particular case of m being the ascent of $A - \lambda I$, i.e., $Ker [(A - \lambda I)^m] = \mathcal{M}_\lambda(A)$, from (5.4) we obtain the decomposition of the phase space C by $\lambda \in \sigma(A)$ given as

$$C = P_\lambda \oplus Q_\lambda, \tag{5.10}$$

where $P_\lambda := \mathcal{M}_\lambda(A)$ and $Q_\lambda := [\mathcal{M}_\lambda(A^*)]^\perp$. It is straightforward to generalize this decomposition to a nonempty finite set $\Lambda = \{\lambda_1, \dots, \lambda_s\} \subset$

$\sigma(A)$. For applications to bifurcation problems, we will as usual fix $\Lambda = \{\lambda \in \sigma(A) : \text{Re } \lambda = 0\}$. The decompositions (5.10), $\lambda \in \Lambda$, yield a decomposition of C by Λ as

$$C = P \oplus Q, \tag{5.11}$$

where

$$P = \mathcal{M}_{\lambda_1}(A) \oplus \dots \oplus \mathcal{M}_{\lambda_s}(A)$$

$$Q = [P^*]^\perp = \{\varphi \in C : \langle\langle \alpha, \varphi \rangle\rangle = 0, \text{ for all } \alpha \in P^*\}$$

and

$$P^* = \mathcal{M}_{\lambda_1}(A^*) \oplus \dots \oplus \mathcal{M}_{\lambda_s}(A^*).$$

Clearly P, Q are invariant subspaces under A and (5.2). One also proves that for any $m, r \in \mathbb{N}$, if $\lambda, \mu \in \sigma(A)$ and $\lambda \neq \mu$, then $\langle\langle \alpha, \varphi \rangle\rangle = 0$ for all $\alpha \in \text{Ker} [(A^* - \lambda I)^m]$ and $\varphi \in \text{Ker} [(A - \mu I)^r]$. By using the Fredholm alternative result, it is therefore possible to choose normalized bases Φ, Ψ for P, P^* ,

$$\Phi = (\Phi_{\lambda_1}, \dots, \Phi_{\lambda_s}), \quad P = \text{span } \Phi$$

$$\Psi = \begin{pmatrix} \Psi_{\lambda_1} \\ \dots \\ \Psi_{\lambda_s} \end{pmatrix}, \quad P^* = \text{span } \Psi_\Lambda$$

where $p = \dim P = \dim P^*$, such that $\langle\langle \Psi, \Phi \rangle\rangle = I_p$.

5.2 Normal forms on centre manifolds

Consider now Eq. (5.1), which can be interpreted as a perturbation of (5.2), and assume that $\Lambda = \{\lambda \in \sigma(A) : \text{Re } \lambda = 0\}$ is nonempty. With the above notations, P is the centre space for (5.2), and $p = \dim P$. Assuming F is a C^1 function, in [69], the existence of a C^1 -smooth p -dimensional centre manifold for (5.2) tangent to P at zero was proven. The following centre manifold theorem states that actually the centre manifold is C^k -smooth.

Theorem 5.7. [43, 69] For (5.1) with F a C^k ($k \geq 1$) function, there is a centre manifold $W_c = \{\varphi \in C : \varphi = \Phi x + h(x), x \in V\}$, where V is a neighbourhood of $0 \in \mathbb{R}^p$, and $h : V \rightarrow Q$ is a C^k -smooth function such that $h(0) = 0, Dh(0) = 0$.

By using the decomposition (5.11), on W_c the flow is given by the ODE

$$\dot{x} = Bx + \langle \Psi(0), F(\Phi x + h(x)) \rangle, \quad x \in V,$$

where Φ, Ψ are normalized dual bases for bases of P, P^* , and B is the $p \times p$ matrix such that $\dot{\Phi} = \Phi B, -\dot{\Psi} = B\Psi$.

Let Eq. (5.1) be written as the abstract ODE (4.6) in the enlarged phase space BC introduced in Section 4. Recall the definition of the extension \tilde{A} of the infinitesimal generator A . Define now an extension of the canonical projection $C = P \oplus Q \rightarrow P$,

$$\pi : BC \rightarrow P, \quad \pi(\varphi + X_0\alpha) = \Phi(\langle\langle \Psi, \varphi \rangle\rangle + \langle \Psi(0), \alpha \rangle).$$

Again, π commutes with \tilde{A} on $C_0^1 = D(\tilde{A})$. Hence BC is decomposed by Λ as

$$BC = P \oplus Ker \pi. \tag{5.12}$$

For $v(t) \in C_0^1$ decomposed according to (5.12), $v(t) = \Phi x(t) + y(t)$ with $x(t) = \langle\langle \Psi, v(t) \rangle\rangle \in \mathbb{R}^p$, $y(t) = (I - \pi)v(t) \in Ker \pi \cap C_0^1 = Q \cap C_0^1 := Q^1$, Eq. (4.6) is equivalent to the system

$$\begin{cases} \dot{x} = Bx + \langle \Psi(0), F(\Phi x + y) \rangle \\ \dot{y} = A_{Q^1}y + (I - \pi)X_0F(\Phi x + y) \end{cases} \tag{5.13}$$

where $A_{Q^1} = \tilde{A}|_{Q^1}$ is as in Section 4.

The algorithm of n.f. now follows along lines similar to the ones in Section 2. Writing the formal Taylor expansion of F ,

$$F(v) = \sum_{j \geq 2} \frac{1}{j!} F_j(v), \quad v \in C,$$

system (5.13) becomes

$$\begin{cases} \dot{x} = Bx + \sum_{j \geq 2} \frac{1}{j!} f_j^1(x, y) \\ \dot{y} = A_{Q^1}y + \sum_{j \geq 2} \frac{1}{j!} f_j^2(x, y) \end{cases}$$

where now the terms of order j are given by

$$f_j^1 = \langle \Psi(0), F(\Phi x + y) \rangle, \quad f_j^2 = (I - \pi)X_0F(\Phi x + y). \tag{5.14}$$

At each step $j \geq 2$, a change of variables of the form

$$(x, y) = (\bar{x}, \bar{y}) + \frac{1}{j!} (U_j^1(\bar{x}), U_j^2(\bar{x})),$$

$(U_j^1 \in V_j^p(\mathbb{R}^p), U_j^2 \in V_j^p(Ker \pi))$ is performed, so that all the non-resonant terms of degree j vanish in the transformed equation. Formally, the operators appearing in the n.f. process are still given by (2.13); however the operators π and A_{Q^1} are as defined in this subsection. Of course, for these operators, results similar to the ones proven for the case of n.f. for FDEs in \mathbb{R}^n must be established. See [39] for complete proofs.

5.3 A reaction-diffusion equation with delay and Dirichlet conditions

For the Hutchinson equation with diffusion,

$$\frac{\partial U(t, x)}{\partial t} = \frac{\partial^2 U(t, x)}{\partial x^2} + kU(t, x)[1 - U(t - r, x)], \quad t > 0, x \in (0, \pi), \quad (5.15)$$

where $k > 0$ and $r > 0$, we consider now Dirichlet conditions

$$U(t, 0) = U(t, \pi) = 0, \quad t \geq 0. \quad (5.16)$$

For (5.15) with Neumann conditions $\frac{\partial U}{\partial x}(0, t) = \frac{\partial U}{\partial x}(\pi, t) = 0$, $t \geq 0$, $U(x, t) \equiv 1$ is the unique positive steady state. In this case, the translation $u = U - 1$ transforms (5.15) into

$$\frac{\partial u(x, t)}{\partial t} = \frac{\partial^2 u(x, t)}{\partial x^2} - ku(x, t - r)[1 + u(x, t)], \quad t \geq 0, x \in (0, \pi),$$

already studied in Example 4.3.

Model (5.15)-(5.16) was first studied by Green and Stech [50]. In [50], it was proven that the equilibrium $U = 0$ is a global attractor of all positive solutions if $k \leq 1$; for $k > 1$, $U = 0$ becomes unstable, and there is a unique positive spatially nonconstant equilibrium U_k , which is locally stable if $rk \max\{U_k(x) : x \in [0, \pi]\} < 1$. This stability criterion was improved to $rk \max\{U_k(x) : x \in [0, \pi]\} < \pi/2$ in [65]. In [23], the authors showed that for $k - 1 > 0$ small, there exists $r(k) > 0$ such that U_k is locally stable if the delay r is less than $r(k)$, and unstable for $r > r(k)$. They also proved that there is a sequence $(r_{k_n})_{n \in \nu_0}$ of Hopf bifurcation points, where $r_{k_0} = r(k)$ is the first bifurcation point.

The study of (5.15) is particularly difficult when Dirichlet conditions (5.16) are assumed. The main problem derives from the fact that, since the equilibria $U_k(x)$ are spatially nonconstant, the characteristic equation associated with the linearization about $U_k(x)$ is a second order differential equation with nonconstant coefficients, subject to constraints given by the boundary conditions. In fact, the characteristic equation is given by

$$\Delta(k, \lambda, r)y = 0, \quad y \in H_0^2 \setminus \{0\}, \quad (5.17)$$

where

$$\Delta(k, \lambda, r) = D^2 + k(1 - U_k) - ke^{-\lambda r}U_k - \lambda,$$

with $D^2 = \frac{\partial^2}{\partial x^2}$, $X = L^2[0, \pi]$, and $H_0^2 = H_0^2[0, \pi] = \{y \in X \mid \dot{y}, \ddot{y} \in X, y(0) = y(\pi) = 0\}$. In the next statement, we summarize the results in [23].

Theorem 5.8. [23] There exists a $k^* > 1$ such that for each fixed $k \in (1, k^*)$, the eigenvalue problem (5.17) has a solution $(i\nu, r, y)$, with $\nu \geq 0, r > 0, y \in H_0^2 \setminus \{0\}$, if and only if

$$\nu = \nu_k, \quad r = r_{k_n}, \quad y = cy_k \quad (c \neq 0), \quad n \in \mathbb{N}_0,$$

where

$$\begin{aligned} \nu_k &= (k - 1)h_k, \quad \text{with } h_k \rightarrow 1 \quad \text{as } k \rightarrow 1^+, \\ r_{k_n} &= \frac{\theta_k + 2n\pi}{\nu_k}, \quad \theta_k \rightarrow \frac{\pi}{2} \quad \text{as } k \rightarrow 1^+, \\ y_k &\rightarrow \sin(\cdot) \text{ in } L^2[0, \pi] \quad \text{as } k \rightarrow 1^+. \end{aligned}$$

Furthermore, the characteristic values $\lambda = i\nu_k$ are simple roots of (5.17) for $r = r_{k_n}$, and for $k \in (1, k^*)$ a Hopf bifurcation arises from the equilibrium U_k as the delay r increases and crosses the critical points $r = r_{k_n}, n \in \mathbb{N}_0$.

In the above theorem, we emphasize that the stationary solutions U_k , the eigenvalues $i\nu_k, -i\nu_k$, the eigenvectors y_k, \bar{y}_k , and the critical values $r_{k_n}, n \in \mathbb{N}_0$, are all known only implicitly.

The aim now is to determine the stability of the periodic solutions near the positive steady state U_k arising from Hopf, as the delay crosses $r_{k_n}, n \in \mathbb{N}_0$. In [23] it was stated without proof that these periodic solutions are stable on the centre manifold. The proof of this statement was given in [42] by using n.f. techniques, where details of the results below can be found.

Fix $k > 1$. Since we want to use the delay r as the bifurcating parameter, it is convenient to normalize the delay by the time-scaling, $\bar{U}(t, x) = U(rt, x)$, and choose $C := C([-1, 0]; X)$ as the phase space. After translating U_k to the origin, for $u(t) = \bar{U}(t, \cdot) - U_k \in X$, (5.15)-(5.16) are written in C as

$$\dot{u}(t) = rD^2u(t) + L_r(u_t) + f(u_t, r), \quad (t \geq 0) \tag{5.18}$$

where for $k > 1$ fixed we denote

$$L_r(\varphi) = rk[(1 - U_k)\varphi(0) - U_k\varphi(-1)], \quad f(\varphi, r) = -rk\varphi(0)\varphi(-1), \quad \varphi \in C.$$

The linearized equation around the equilibrium U_k is given by

$$\dot{u}(t) = rD^2u(t) + L_r(u_t), \tag{5.19}$$

whose solution operator has infinitesimal generator A_r defined by

$$\begin{aligned} A_r\phi &= \dot{\phi}, \\ \mathcal{D}(A_r) &= \{\phi \in C^1([-r, 0]; X) : \phi(0) \in H_0^2, \dot{\phi}(0) = r[D^2 + k(1 - U_k)]\phi(0) - rkU_k\phi(-r)\}. \end{aligned}$$

Due to the time-scaling, the characteristic equation for (5.19) becomes

$$\begin{aligned} \Delta(k, \lambda, r)y &= 0, \quad y \in H_0^2 \setminus \{0\} \\ \Delta(k, \lambda, r) &= r[D^2 + k(1 - U_k) - ke^{-\lambda}U_k] - \lambda. \end{aligned} \tag{5.20}$$

We now describe briefly the framework for the application of the n.f. method. One must compute the n.f. for the 2-dimensional ODE giving the flow on the centre manifold for (5.18) at the bifurcating points $r = r_{k_n}, n \in \mathbb{N}_0$.

Let $k > 1$ and $n \in \mathbb{N}_0$ be fixed. For $r = r_{k_n}$, set $\Lambda = \Lambda_{k,n}$ as the set of eigenvalues on the imaginary axis,

$$\Lambda = \{i\lambda_{k_n}, -i\lambda_{k_n}\},$$

and decompose $C = P \oplus Q$ and $BC = P \oplus Ker \pi$ by Λ via the formal adjoint theory in Section 5.1. Consider the scaling $r = r_{k_n} + \alpha$, and write (5.18) as

$$\dot{u}(t) = r_{k_n}D^2u(t) + L_{r_{k_n}}u_t + F(u_t, \alpha), \tag{5.21}$$

where

$$\begin{aligned} L_{r_{k_n}}(\varphi) &= r_{k_n}k[(1 - U_k)\varphi(0) - U_k\varphi(-1)], \\ F(\varphi, \alpha) &= \alpha D^2\varphi(0) + L_\alpha(\varphi) + f(\varphi, r_{k_n} + \alpha), \end{aligned}$$

For the Taylor expansion $F(u_t, \alpha) = \frac{1}{2}F_2(u_t, \alpha) + \frac{1}{3!}F_3(u_t, \alpha)$, we have $F_2(u_t, \alpha) = 2\alpha[D^2u(t) + k(1 - U_k)u(t) - kU_ku(t - 1)] - kr_{k_n}u(t)u(t - 1)$, $F_3(u_t, \alpha) = -3!k\alpha u(t)u(t - 1)$. For the linearization $\dot{u}(t) = r_{k_n}D^2u(t) + L_{r_{k_n}}u_t$, we can choose normalized dual bases Φ, Ψ for P, P^* as

$$\begin{aligned} P &= \text{span } \Phi, \quad \Phi(\theta) = [\phi_1(\theta) \ \phi_2(\theta)] = [y_k e^{i\lambda_{k_n}\theta} \ \bar{y}_k e^{-i\lambda_{k_n}\theta}] \quad (-1 \leq \theta \leq 0) \\ P^* &= \text{span } \Psi, \quad \Psi(s) = \begin{pmatrix} \psi_1(s) \\ \psi_2(s) \end{pmatrix} = \begin{pmatrix} \frac{1}{S_{k_n}} y_k e^{-i\lambda_{k_n}s} \\ \frac{1}{\bar{S}_{k_n}} \bar{y}_k e^{i\lambda_{k_n}s} \end{pmatrix} \quad (0 \leq s \leq 1), \end{aligned}$$

where

$$S_{k_n} = \int_0^\pi [1 - kr_{k_n}e^{-i\theta k}U_k(x)]y_k^2(x)dx.$$

With the usual notations, in BC decomposed by Λ , (5.21) is written as

$$\begin{cases} \dot{x} = Bx + \langle \Psi(0), F(\Phi x + y, \alpha) \rangle \\ \dot{y} = \tilde{A}_{Q^1}y + (I - \pi)X_0F(\Phi x + y, \alpha), \end{cases} \tag{5.22}$$

where $x(t) \in \mathbb{C}^2, y(t) \in Q^1 = Q \cap C_0^1$, and $B = \begin{pmatrix} i\lambda_{k_n} & 0 \\ 0 & -i\lambda_{k_n} \end{pmatrix}$.

The application of the n.f. method to (5.22) leads to the following result:

Theorem 5.9. [42] Let k, n be fixed, with $k \in (1, k^*)$ and $n \in \mathbb{N}_0$. The n.f. up to cubic terms for the flow on the centre manifold of the origin near $\alpha = 0$ is given in polar coordinates (ρ, ξ) by

$$\begin{cases} \dot{\rho} = K_1 \alpha \rho + K_2 \rho^3 + O(\alpha^2 \rho + |(\rho, \alpha)|^4) \\ \dot{\xi} = -\sigma_n + O(|(\rho, \alpha)|), \end{cases}$$

where $\alpha = r - r_{k_n}$, $K_1 = Re A_1, K_2 = Re A_2$,

$$A_1 = A_1(k, n) = i\nu_k \frac{1}{S_{k_n}} \langle y_k, y_k \rangle$$

$$A_2 = A_2(k, n) = \frac{1}{4} [C_1(k, n) + C_2(k, n)]$$

and

$$C_1 = C_1(k, n) = \frac{8k^2 r_{k_n} i}{\nu_k} \left[\frac{1}{S_{k_n}^2} Re(e^{i\theta_k}) e^{-i\theta_k} \langle y_k, y_k^2 \rangle \langle y_k, |y_k|^2 \rangle - \frac{1}{|S_{k_n}|^2} \left(2(Re(e^{i\theta_k}))^2 \langle y_k, |y_k|^2 \rangle + \frac{1}{3} \langle y_k, \bar{y}_k^2 \rangle \right) \right]$$

$$C_2 = C_2(k, n) = - \frac{2kr_{k_n}}{S_{k_n}} \left[\langle y_k, (h_{11}(-1) + h_{11}(0)e^{-i\theta_k}) y_k \rangle + \langle y_k, (h_{20}(-1) + h_{20}(0)e^{i\theta_k}) \bar{y}_k \rangle \right],$$

and $h_{20}, h_{11} \in Q^1$ are the solutions of the IVPs, respectively,

$$\dot{h}_{20} - 2i\lambda_{k_n} h_{20} = -2kr_{k_n} e^{-i\theta_k} \left\{ \frac{1}{S_{k_n}} \langle y_k, y_k^2 \rangle y_k e^{i\lambda_{k_n} \theta} + \frac{1}{\bar{S}_{k_n}} \langle \bar{y}_k, \bar{y}_k^2 \rangle \bar{y}_k e^{-i\lambda_{k_n} \theta} \right\},$$

$$\dot{h}_{20}(0) - r_{k_n} \{ D^2 h_{20}(0) + k(1 - U_k) h_{20}(0) - kU_k h_{20}(-1) \} = -2kr_{k_n} e^{-i\theta_k} y_k^2,$$

and

$$\dot{h}_{11} = -4kr_{k_n} Re(e^{i\theta_k}) \left\{ \frac{1}{S_{k_n}} \langle y_k, |y_k|^2 \rangle y_k e^{i\lambda_{k_n} \theta} + \frac{1}{\bar{S}_{k_n}} \langle \bar{y}_k, |y_k|^2 \rangle \bar{y}_k e^{-i\lambda_{k_n} \theta} \right\}$$

$$\dot{h}_{11}(0) - r_{k_n} \{ D^2 h_{11}(0) + k(1 - U_k) h_{11}(0) - kU_k h_{11}(-1) \} = -4kr_{k_n} Re(e^{i\theta_k}) |y_k|^2.$$

Note that the coefficients $K_1 = K_1(k, n)$ and $K_2 = K_2(k, n)$ depend on k, n and are given in terms of the coefficients of the original equation. The first equation of the system for both h_{20}, h_{11} is a linear ODE that can be easily solved. However, the second equation requires the resolution of

a PDE with non-constant coefficients and Dirichlet boundary conditions on $[0, \pi]$. Since the solutions cannot be explicitly computed, the signs of the meaningful constants K_1 and K_2 have to be determined by indirect methods. This requires hard computations, whose conclusions we give in the next theorem. Note that these results hold for $k > 1$ close to 1. An interesting question is whether the results persist for large $k > 1$.

Theorem 5.10. [42] Fix $k \in (1, k^*)$ and $n \in \mathbb{N}_0$. Then for $0 < k - 1 \ll 1$, $K_1(k, n) > 0$ and $K_2(k, n) < 0$. Therefore a supercritical Hopf bifurcation occurs at $r = r_{k_n}$, with stable non-trivial periodic solutions on the centre manifold.

References

- [1] M. Ait Babram, O. Arino and M.L. Hbid, Computational scheme of a center neutral manifold for fonctionnal differential equations, *J. Math. Anal. Appl.* **258** (2001), 396–414.
- [2] M. Ait Babram, M.L. Hbid and O. Arino, Approximation scheme of a center manifold for fonctionnal differential equations, *J. Math. Anal. Appl.* **213** (1997), 554–572.
- [3] M. Ait Babram, M.L. Hbid, and O. Arino, Existence of periodic solutions for a delay differential equation via an approximation of center manifold. (preprint).
- [4] M. Adimy, Bifurcation de Hopf locale par les semi groupes intégrés, *C.R. Acad. Sci. Paris Série I* **311** (1990), 423–428.
- [5] M. Adimy, Integrated semigroups and delay differential equations, *J. Math. Anal. Appl.* **177** (1993), 125–134.
- [6] M. Adimy, Hopf global bifurcation for retarded differential equations using integrated semigroups, (preprint).
- [7] M. Adimy and K. Ezzinbi, Integrated semigroups and functional differential equation in infinite dimension, to appear in *C.R.Acad. Sci.*
- [8] M. Adimy et K. Ezzinbi, Equations de type neutre et semi groupes intégrés, *C. R. Acad. Sci. Paris Série I* **318** (1994), 529–534.
- [9] W. Arendt, Resolvent positive operators and integrated semigroup, *Proc. London Math. Soc.*, 3, vol 54, 321–349, 1987.
- [10] W. Arendt, Vector valued laplace transforms and cauchy problems, *Israel J. Math* **59** (1987), 327–352.
- [11] O. Arino and R. Benkhalti, Periodic solutions for $x'(t) = f(x(t), x(t - \omega))$, *Proceeding of Royal Society of Edinburgh* **109A** (1989), 245–260.

- [12] O. Arino and A. Cherif, An exact formula of period π -solution of $x'(t) = -\lambda f(x(t-1))$ which bifurcate at $\lambda = \frac{\pi}{2}$, *J. Diff. Int. Eqns.* **2** (1989), 361–385.
- [13] O. Arino and M.L. Hbid, Periodic solution of retarded differential systems close to ordinary ones. *Nonlinear Anal. T.M.A.* **14** (1990).
- [14] O. Arino and M.L. Hbid, Poincaré procedure for an ordinary differential system perturbed by a functional term, *D.E.D.S.* **2** (1994).
- [15] O. Arino and M.L. Hbid, Existence of periodic solutions for a delay differential equation via the Poincare procedure, *D.E.D.S.* **4** (1996), 125–148.
- [16] O. Arino and E. Sanchez, Linear theory of abstract functional differential equations of retarded type, *J. Math. Anal. Appl.* **191** (1995), 547–571.
- [17] O. Arino et E. Sanchez, A variation of constants formula for an abstract functional-differential equation of retarded type, *Diff. Int. Eq.* **9** (1996), 1305–1320.
- [18] J. Belair and S. Dufour, Stability in a three -dimensional system of delay differential equations. *Canad. Appl. math. Quart.* **4** (1996), 135–155.
- [19] R. Bellman and K.L. Cooke, “Differential difference equations”, Academic Press, New York (1963).
- [20] S.R. Bernfeld, P. Negrini and L. Salvadori, Quasi-invariant manifolds, stability and generalized Hopf bifurcation, *Annali di Matematica pura and applicata* **4** (1982).
- [21] S.R. Bernfeld and L. Salvadori, Generalized Hopf bifurcation and h-asymptotic stability, *Nonlinear Anal. TMA* **4** (1980).
- [22] S. Busenberg and B. Wu, Convergence theorems for integrated semi-group, *Diff. Int. Eq.* **5** (1992), 509–520.
- [23] S. Busenberg and W. Huang, Stability and Hopf bifurcation for a population delay model with diffusion effects, *J. Differential Equations* **124** (1996), 80–107.
- [24] J. Carr, “Applications of Center Manifold Theory”, Springer-Verlag, New York, 1981.

- [25] N. Chafee, Generalized Hopf bifurcation and perturbation in full neighbourhood of a given vector field. *Indiana Univ. Math. J.* **27** (1978).
- [26] N. Chafee, A bifurcation problems for functional differential equation of finitely retarded type, *J. Math. Anal. Appl.* **35** (1971).
- [27] P. Clément, O. Diekmann, M. Gyllenberg, H.J.A.M. Heijmans and H.R. Thieme, Perturbation theory for dual semigroups. I. The sun-reflexive case, *Math. An.* **277** (1987), 709–725.
- [28] S.N. Chow, Existence of periodic solutions of autonomous functional differential equations, *J. Differential Equations* **15** (1974), 350–378.
- [29] S.N. Chow and J.K. Hale, “Methods of Bifurcation Theory”, Springer-Verlag, New York, 1982.
- [30] S.N. Chow and J. Mallet-Paret, Integral averaging and bifurcation, *J. Differential Equations* **26** (1977), 112–159.
- [31] J.M. Cushing, Periodic solutions of two species interactions models with lags, *Math. Biosci.* **31** (1977), 143–156.
- [32] G. Da Prato and E. Sinestrari, Differential operators with non-dense domains, *Ann. Scuola Norm. Sup. Pisa Cl. Sci. (4)* **14** (1988), 285–344.
- [33] O. Diekmann and S. van Gils, The center manifold for delay equations in light sun stars, Singularity Theory and its Application, M.Roberts, I.N.Stewart (eds), Warwick, 1989, Part II, Springer L.N.M 1464, 122–141, 1991.
- [34] P. Dormayer, Exact formula for periodic solutions of $\frac{dx(t+1)}{dt} = -\alpha x(t) + bx^3(t)$, *J. Applied Math and Physics (ZAMP)* **37** (1986).
- [35] T. Faria, Normal forms for periodic retarded functional differential equations, *Proc. Roy. Soc. Edinburgh* **127A** (1997), 21–46.
- [36] T. Faria, Bifurcations aspects for some delayed population models with diffusion, *Fields Institute Communications* **21** (1999), 143–158.
- [37] T. Faria, Normal forms and Hopf bifurcation for partial differential equations with delays, *Trans. Amer. Math. Soc.* **352** (2000), 2217–2238.
- [38] T. Faria, On a planar system modelling a neuron network with memory, *J. Differential Equations* **168** (2000), 129–149.

- [39] T. Faria, Normal forms for semilinear functional differential equations in Banach spaces and applications. Part II, *Disc. Cont. Dyn. Systems* **7** (2001), 155–176.
- [40] T. Faria, Stability and bifurcation for a delayed predator-prey model and the effect of diffusion, *J. Math. Anal. Appl.* **254** (2001), 433–463.
- [41] T. Faria, On the Study of Singularities for a Planar System with Two Delays, *Dyn. Cont. Disc. Impul. Systems A* **10** (2003), 357–372.
- [42] T. Faria and W. Huang, Stability of periodic solutions arising from Hopf bifurcation for a reaction-diffusion equation with time delay, *Fields Institute Communications* **31** (2002), 125–141.
- [43] T. Faria, W. Huang and J. Wu, Smoothness of center manifolds for maps and formal adjoints for semilinear FDEs in general Banach spaces, *SIAM J. Math. Anal.* **34** (2002), 173–203.
- [44] T. Faria and L. T. Magalhães, Normal forms for retarded functional differential equations and applications to Bogdanov-Takens singularity, *J. Differential. Equations* **122** (1995), 201–224.
- [45] T. Faria and L. T. Magalhães, Normal forms for retarded functional differential equations with parameters and applications to Hopf singularity, *J. Differential Equations* **122** (1995), 181–200.
- [46] W. Fitzgibbon, Semilinear Equations functional differential equations in Banach spaces, *J. Differential Equations* **29** (1978), 1–14.
- [47] F. Giannakopoulos and A. Zapp, Bifurcations in a planar system of differential delay equations modeling neural activity, *Physica D* **159** (2001), 215–232.
- [48] A. Grabosch and U. Moustakas, A semigroup approach to retarded differential equations, in “One-parameter semigroups of positive operators” (R.Nagel, ed.), pp 219–232, Lecture Notes in Mathematics, Vol. 1184, Springer-Verlag, Berlin/New York, (1986).
- [49] R.B. Grafton, A periodicity theorem for autonomous functional differential equation, *J. Differential Equations* **6** (1980).
- [50] D. Green and H. Stech, Diffusion and hereditary effects in a class of population models, in *Differential Equations and Applications in Ecology, Epidemics and Population Problems* (S. Busenberg and C. Cooke, Eds.), pp. 19–28, Academic Press (1981).

- [51] R. Grimmer, Existence of periodic solution of functional differential equation, *J. Math. Anal. Appl.* **72** (1979).
- [52] K.P. Hadeler and J. Tomiuk, Periodic solutions of difference differential equations. *Arch. Rat. and Anal.* **1** (1977), 87–95.
- [53] J.K. Hale, Theory of Functional Differential Equations, Springer Verlag (1977).
- [54] J.K. Hale, Large diffusivity and asymptotic behavior in parabolic systems, *J. Differential Equations* **118** (1986), 455–466.
- [55] J.K. Hale, Critical cases for neutral functional differential equations, *J. Differential Equations* **10** (1971), 59–82.
- [56] J.K. Hale and W. Huang, Period Doubling in singularly perturbed delay equations, *J. Differential Equations* **114** (1994), 1–23.
- [57] J.K. Hale and S.M. Tanaka, Square and pulse waves with two delays, *J. Dynam. Diff. Eq.* **12** (2000), 1–30.
- [58] J.K. Hale and S.M. Verduyn Lunel, “Introduction to Functional Differential Equations”, Springer-Verlag, New-York (1993).
- [59] J.K. Hale and M. Weebermann, On perturbations of delay-differential equations with periodic orbits, *J. Differential Equations* **197** (2004), 219–246.
- [60] B.D. Hassard, N.D. Kazarinoff, and Y.H. Wan, “Theory and applications of Hopf bifurcation”, Cambridge University Press, Cambridge (1981).
- [61] M.L. Hbid, Contribution à l’étude des perturbations des équations différentielles à retard, Thèse de Doctorat d’Etat de l’Université Mohamed V, Rabat, Maroc (1992).
- [62] A.V.M. Herz, Solutions of $x'(t) = -g(x(t-1))$ approach the Kaplan-Yorke orbits for odd sigmoid g , *J. Differential Equations* **118** (1995), 36–53.
- [63] D. Henry, “Geometric Theory of Semilinear Parabolic Equations”, Lecture Notes in Math. Vol. 840, Springer-Verlag, New York/Berlin, 1981.
- [64] E. Hille and S. Phillips, “Functional analysis and semigroups”, Amer. Math. Soc., Providence, R.I. (1957).

- [65] W. Huang, On asymptotical stability for a linear delay equations, *J. Diff. Integ. Equations* **4** (1991), 1303–1316.
- [66] J. Kaplan and J. Yorke, Ordinary differential equations which yields periodic solutions of differential delay equations. *J. Math. Anal. Appl.* **48**, 1974.
- [67] F. Kappel, Linear autonomous functional differential equations, cours de l'école d'été sur les équations différentielles à retard, Marrakech June 1995.
- [68] H. Kellerman, Integrated semigroups, (thesis) Tübingen (1986).
- [69] T. Krisztin, H.-O. Walther and J. Wu, "Shape, Smoothness and Invariant Stratification of an Attracting Set for Delayed Monotone Positive Feedback", The Fields Institute Monograph Series, American Mathematical Society, Providence, 1999.
- [70] K. Kunish and W. Schappacher, Variation of constants formula for partial differential equations with delay, *Nonlinear Anal. TMA* **5** (1981), 123–142.
- [71] K. Kunish and W. Schappacher, Necessary conditions for partial differential equations with delay to generate a C_0 -semigroup, *J. Differential Equations* **50** (1983), 49–79.
- [72] B.W. Levinger, A Folk theorem in functional differential equations, *J. Differential Equations* **4** (1968), 612–619.
- [73] X. Lin, J.W.-H. So and J. Wu, Centre manifolds for partial differential equations with delays, *Proc. Roy. Soc. Edinburgh* **122A** (1992), 237–254.
- [74] A.M. Lyapounov, "Problème général de la stabilité du mouvement", Ann. of Math Studies **17**, Princeton University Press, New Jersey, (1947).
- [75] J. Mallet-Paret, Generic periodic solutions of functional differential equation. *J. Differential Equations* **25** (1977), 163–183.
- [76] J.E. Marsden and M. McCracken, The Hopf bifurcation and its applications, Springer-Verlag, New York, (1976).
- [77] M.C. Memory, Stable and unstable manifolds for partial functional differential equations, *Nonlinear Anal. TMA* **16** (1991), 131–142.
- [78] P. Negrini and L. Salvadori, Attractivity and Hopf bifurcation. *Nonlinear Anal. T.M.A* **3** (1979).

- [79] F. Neubrander, Integrated semigroups and their applications to the abstract Cauchy problems, *Pacific J. Math.* **135** (1988), 111–155.
- [80] R.D. Nussbaum, Periodic solutions of some nonlinear functional differential equations, *Ann. Mat. Pura Appl.* **101** (1974), 263–338.
- [81] R.D. Nussbaum, Periodic solutions of some nonlinear functional differential equations, II, *J. Differential Equations* **14** (1973), 360–394.
- [82] R. Nussbaum, The range of periods of periodic solutions of $x'(t) = -\alpha f(x(t-1))$, *J. Math. Anal. Appl.* **58** (1977).
- [83] R. Nussbaum, A global Hopf bifurcation theorem of functional differential systems, *Trans. Amer. Math. Soc.* **238** (1978), 139–164.
- [84] A. Pazy, “Semigroups of Linear Operators and Applications to partial differential Equations”, Springer-Verlag, New York, 1983.
- [85] W.M. Ruess, Existence and stability of solutions to partial functional differential equations with delay, *Advances in Diff. Eqs.* **4** (1999), 843–876.
- [86] W.M. Ruess and W.H. Summers, Linearized stability for abstract differential equations with delay, *J. Math. Anal. Appl.* **198** (1996), 310–336.
- [87] H.W. Stech, The Hopf bifurcation: a stability result and applications, *J. Math. Anal. Appl.* **109** (1985), 472–491.
- [88] H. Talibi, Contribution à l’étude du problème de bifurcation de Hopf locale dans le cadre des équations différentielles à retard. Doctorat d’Etat de l’Université Mohamed V, Rabat, Maroc (1992).
- [89] F. Takens, Unfolding of certain singularity of vector field ; generalized Hopf bifurcation, *J. Differential Equations* **14** (1973), 476–493.
- [90] A.E. Taylor and D.C. Lay, “Introduction to Functional Analysis”, Willey, New York, 1980.
- [91] H. Thieme, Integrated semigroups and integrated solutions to abstract cauchy problems, *J. Math. Anal. Appl.* **152** (1990), 416–447.
- [92] C.C. Travis and G.F. Webb, Existence and stability for partial functional differential equations, *Trans. Amer. Math. Soc.* **200** (1974), 395–418.

- [93] C.C. Travis and G.F. Webb, Partial differential equations with deviating arguments in the time variable, *J. Math. Anal. Appl.* **56** (1976), 397–409.
- [94] C.C. Travis and G.F. Webb, Existence, stability and compactness in the α -norm for partial functional differential equations, *Trans. Amer. Math. Soc.* **240** (1978), 129–143.
- [95] A. Vanderbauwhede and G. Iooss, Center manifold theory in infinite dimension, *Dynam. Report. Expositions Dynam. Systems (N.S.)* **1** (1992).
- [96] H.-O. Walther, A theorem on the amplitudes of periodic solutions of differential delay equations with application to bifurcation, *J. Differential Equations* **29** (1978), 396–404.
- [97] H.O. Walther, Bifurcation from solutions in functional differential equations. *Math. Z.* **182** (1983).
- [98] G.F. Webb, “Theory of Nonlinear Age-Dependent Population Dynamics”, Marcel Dekker, New York, (1985).
- [99] M. Weederemann, Normal forms for neutral functional differential equations, *Fields Institute Communications* **29** (2001), 361–368.
- [100] E.M. Wright, A non linear differential difference equation, *J. Reine Angew. Math.* **194** (1955), 66–87.
- [101] J. Wu, “Theory and Applications of Partial Functional Differential Equations”, Springer-Verlag, New York, 1996.
- [102] J. Wu, T. Faria and Y. S. Huang, Synchronization and stable phase-locking in a network of neurons with memory, *Mathematical and Computer Modelling* **30** (1999), 117–138.
- [103] D. Xiao and S. Ruan, Multiple bifurcations in a delayed predator-prey system with nonmonotonic functional response, *J. Differential Equations* **176** (2001), 495–510.
- [104] K. Yoshida, The Hopf bifurcation and its stability for semilinear diffusion equations with time delay arising in ecology, *Hiroshima Math. J.* **12** (1982), 321–348.

III

**FUNCTIONAL DIFFERENTIAL
EQUATIONS IN INFINITE
DIMENSIONAL SPACES**

Chapter 8

A THEORY OF LINEAR DELAY DIFFERENTIAL EQUATIONS IN INFINITE DIMENSIONAL SPACES

O. Arino

UR Géodes.– IRD, Centre de Bondy.

32, Av. Henri Varagnat.– 93143 Bondy cedex.– France.

ovide.arino@bondy.ird.fr

E. Sánchez

Departamento de Matemáticas.– E.T.S.I. Industriales .

c. José Gutiérrez Abascal, 2.– 28006 Madrid.– Spain.

esanchez@math.etsii.upm.es

1. Introduction

This section is intended to motivate the interest in abstract differential delay equations (DDE) by means of examples. When thinking about extending functional differential equations from finite to infinite dimensions, one of the first and main examples which comes to mind is the case of evolution equations combining diffusion and delayed reaction. This is the situation in the first example that we are going to present, which is a model proposed by A. Calsina and O. El Idrissi ([11]), which joins spatial diffusion with demographic reaction.

But it is not the only situation one can think of: we also present a second example which arises from a model of cell proliferation first introduced by M. Kimmel et al. in [24]. Several modified versions of this model were proposed and studied later. In most treatments, it is viewed as an integro-difference equation and solved using a step-by-step procedure ([2], [3], [36]). While this technique offers the advantage of allowing explicit integration in terms of the initial function, it has also some deficiencies specially when looking at nonlinear perturbations

and dynamical features, which are better studied in the framework of differential equations than in the one of integral equations.

1.1 A model of fish population dynamics with spatial diffusion ([11])

Let us consider a fish population divided into two stages, young and adults, distributed within the water column, which is represented by an interval of the real line. A crucial assumption is that only the youngsters may move in the water column randomly, their movement being described by a diffusion coefficient. The adults are structured by the position they had when turning adult.

We introduce the following variables: $t \in \mathbf{R}$ is the chronological time, $a \in [0, l]$ is the age, where $l < +\infty$ is the age of maturity, and $z \in [0, z^*]$ is the position in the water column, where z^* is the depth, oriented positively from the water surface to the bottom. Then, the model is formulated in terms of the following state variables:

- i) $u(a, t, z)$ is the density of young fish of age a , at depth z , at time t .
- ii) $v(t, z)$ is the density of the adult population at depth z at time t .
- iii) $r(t)$ is the maximum available resource at time t .

The system of equations satisfied by u, v, r , reads as:

$$\left\{ \begin{array}{l} \frac{\partial u}{\partial a}(a, t, z) + \frac{\partial u}{\partial t}(a, t, z) = \frac{\partial}{\partial z} \left[k(z) \frac{\partial u}{\partial z}(a, t, z) \right] - m_1(r(t))u(a, t, z) \\ \frac{\partial v}{\partial t}(t, z) = u(l, t, z) - m_2(r(t))v(t, z) \\ r'(t) = \left(g(r(t)) - h \left[L \left(\int_0^l \int_0^{z^*} u(a, t, z) da dz, v(t, \cdot) \right) \right] \right) r(t) \\ u(0, t, z) = \int_0^{z^*} b(z, \xi)v(t, \xi) d\xi \\ \frac{\partial u}{\partial z}(a, t, 0) = 0 \\ u(a, 0, z) = u_0(a, z) \quad ; \quad v(0, z) = v_0(z) \quad ; \quad r(0) = r_0. \end{array} \right. \tag{1.1}$$

In the above system:

- The function $k(z)$ represents the mixing coefficient due to water turbulence. It is continuous, positive on $[0, z^*)$ and $k(z^*) = 0$.
- The functions $m_i(r)$ are mortality rates for the young fish ($i = 1$) and the adults ($i = 2$). They are smooth and decreasing with a positive infimum.

- The function $b = b(z, \xi)$ is the fertility rate of the adults combined with a mixing process of the newborns throughout the water column: it can be for example that, for some physiological reason, the eggs produced at any level have a density lower than the water and go to the surface as a result of Archimedes law.
- The function $g(r)$ is smooth and decreasing and changes signs at some critical value r_c . It may be interpreted as the logistic which would govern the dynamics of the resource in the absence of consumption by fish.
- L is a positive linear functional which gives the total potential pressure of the fish on the resource, while the function h is a bounded smooth and increasing function, with $h(0) = 0$, which models a limiting effect on resource accessibility caused by overcrowding.

By concentrating on age cohorts, i.e. groups of individuals born at the same time, and using the representation of the solution to the Cauchy problem for the parabolic equation

$$\begin{aligned} \frac{\partial w}{\partial t}(t, z) &= \frac{\partial}{\partial z}[k(z)w(t, z)] \\ \frac{\partial w}{\partial z}(t, 0) &= 0 \\ w(0, z) &= w_0(z) \end{aligned}$$

in terms of the fundamental solution of the problem, namely ([89]):

$$w(t, z) = \int_0^{z^*} K(t, z, \xi)w_0(\xi) d\xi$$

system (1.1) leads to the following

$$\left\{ \begin{aligned} \frac{\partial v}{\partial t}(t, z) &= e^{-\int_{-l}^0 m_1(r(t+s)) ds} \int_0^{z^*} K(l, z, \xi) \left(\int_0^{z^*} b(\xi, \zeta)v(t-l, \zeta) d\zeta \right) d\xi \\ &\quad - m_2(r(t))v(t, z) \quad , \quad \text{for } t > l \\ r'(t) &= (g(r(t)) - h[L(p(t), v(t, .))])r(t) \quad , \quad \text{for } t > l \\ v(t, z) &= v_0(t, z) \quad , \quad \text{for } 0 \leq t \leq l \\ r(t) &= r_0(t) \quad , \quad \text{for } 0 \leq t \leq l \end{aligned} \right. \tag{1.2}$$

where $p(t)$ is given by

$$p(t) = \int_0^l \int_0^{z^*} e^{-\int_{-l}^0 m_1(r_t(s)) ds} \left[\int_0^{z^*} K(a, z, \xi) \left(\int_0^{z^*} b(\xi, \zeta)v(t-a, \zeta) d\zeta \right) d\xi \right] dz da.$$

Looking at the right hand side of the two equations in system (1.2), we can see that each of them is made up of a combination of expressions involving the values of the unknown functions v or r either at time t or at some earlier time: the integral in the exponential term is expressed in terms of the values of r over the interval $[t-l, t]$ while the other integral uses $v(t-l, \zeta)$. Under some reasonable assumptions on the coefficients, these quantities are smooth functions of $v(t, \cdot)$ or $v(t - \cdot, \cdot)$ and $r(t - \cdot)$. It is in fact a delay differential equation defined on a space of functions. The difference with the initial formulation is that system (1.1) involves partial derivatives with respect to z and so requires additional regularity on the functions v and r to make sense.

Notice that (1.1) has been formulated from $t = 0$ while (1.2) only holds for $t > l$. This means that if we were to solve the equation with initial value given at $t = 0$, we could not do it using system (1.2). We would have to use (1.1) to build up the solution on the interval $[0, l]$ and we would then be able to solve the equation for $t > l$ by using (1.2). On the other hand, we can always solve (1.2) directly, choosing a pair of functions v_0, r_0 arbitrarily. Of course, in most cases, what we will obtain is not a solution of (1.1). Only some of the solutions of (1.2) are also solutions of (1.1).

So what is the point of looking at (1.2) when the problem to be solved is (1.1)? There are at least two reasons: first of all, the Cauchy problem associated with system (1.2) is much simpler than the one for (1.1). It is a system of delay differential equations: even if it is formulated in a space of infinite dimensions, it does not involve an unbounded operator and can be solved, at least theoretically, by setting up a fixed point problem which can be shown to be a strict contraction for time small enough. The second and main reason is that real systems are normally expected to converge asymptotically towards their attractor where the transients entailed by a particular initial condition vanish: in this respect, systems (1.1) and (1.2) are indistinguishable, while the study of qualitative properties of (1.2) is, at least conceptually, easier than that of a system of partial differential equations.

1.2 An abstract differential equation arising from cell population dynamics

In the model elaborated by M. Kimmel et al. and reported in [24], cells are classified according to some constituent which, after division (by mitosis) is divided in some stochastic way between the two daughter cells. The model considers the cells only at two distinct stages:

- a) At mitosis, the number of cells going through mitosis (that is, the mother cells), in some time interval $[t_1, t_2]$, with a size in some size interval $[x_1, x_2]$, is determined in terms of a density function $m(t, x)$:

$$\int_{t_1}^{t_2} \int_{x_1}^{x_2} m(t, x) dt dx.$$

- b) At the beginning of the cycle, just after division, the number of cells born during the time interval $[t_1, t_2]$, with a size in some size interval $[x_1, x_2]$ is determined in terms of a density function $n(t, x)$:

$$\int_{t_1}^{t_2} \int_{x_1}^{x_2} n(t, x) dt dx.$$

The distribution of sizes from mother to daughter is modelled by a conditional probability density, a function $f(x, y)$ such that:

$$\int_{x_1}^{x_2} f(x, y) dx = \begin{array}{l} \text{probability for a daughter cell born from a mother cell} \\ \text{of size } y \text{ to have size between } x_1 \text{ and } x_2. \end{array}$$

Other conditions on f include a support property: it is assumed that there exist $d_1, d_2, 0 < d_1 < 1/2 < d_2 < 1$, such that

$$f(x, y) > 0 \text{ if and only if } d_1 y < x < d_2 y.$$

The model is completed by two functions describing respectively:

- 1) The duration of a cycle in terms of the initial size

$$T = \Psi(x),$$

where Ψ is positive, decreasing, $\Psi(+\infty) > 0$, continuously differentiable and such that $\inf_{a \leq x \leq b} |\Psi'(x)| > 0$ on each interval $[a, b]$, $0 < a \leq b < +\infty$.

- 2) The size at division in terms of the initial size

$$y = \Phi(x),$$

where Φ is increasing, $\Phi(x) > x$ for $x > 0$, Φ is continuously differentiable and such that $\inf_{a \leq x \leq b} \Phi'(x) > 0$ on each interval $[a, b]$, $0 < a \leq b < +\infty$.

From these basic assumptions, one can derive two fundamental equations relating the state functions n and m (see [24]). Eliminating m from the two equations leads to

$$n(t, x) = 2 \int_0^{+\infty} f(x, \Phi(y)) n(t - \Psi(y), y) dy. \quad (1.3)$$

The assumption on the support of f induces a support property for n ; that is, if we assume that $n(s, x) = 0$ for all x outside an interval $[A_1, A_2]$, $0 < A_1 \leq A_2 < +\infty$, and $s < t$, then equation (1.3) yields:

$$n(t, x) = 0 \quad \text{for } x < d_1\Phi(A_1) \quad \text{or } x > d_2\Phi(A_2).$$

Assuming that

$$d_1\Phi'(0) > 1 \quad \text{and} \quad d_2 \limsup_{x \rightarrow +\infty} \frac{\Phi(x)}{x} < 1,$$

we deduce from the above remark that for any $A_1 > 0$ small enough, and $A_2 < +\infty$, large enough, the size interval $[A_1, A_2]$ is invariant, that is, all generations of cells born from cells with initial size in $[A_1, A_2]$ will have size at birth in the same interval. Note that for such cells the cell cycle length is bounded above by the number

$$r = \Psi(A_1). \quad (1.4)$$

Assuming all the above conditions hold, choosing A_1, A_2 as we just said, r being given by formula (1.4), it was proved in [24] that equation (1.3) yields a positive semigroup in the space

$$E = L^1((-r, 0) \times (A_1, A_2)),$$

that is, the one parameter family of maps which to any initial function $p \in E$ associates the function denoted n_t , $t \geq 0$:

$$n_t(\theta, x) := n(t + \theta, x) \quad , \quad -r \leq \theta < 0 \quad , \quad x \in (A_1, A_2),$$

with $n_0 = p$, where n verifies equation (1.3)) for all $t \geq 0$, determines a strongly continuous semigroup of positive operators on E ([84]) which, moreover, are compact for t large enough.

As a brief comment on the original proof of this result, let us point out that the right-hand side of (1.3) is explicitly determined in terms of the initial function p , for all $0 < t < \Psi(A_2)$. So, the solution can be computed on the set $(0, \Psi(A_2)) \times (A_1, A_2)$ by a straight integration of the initial function. Then, taking $n_{\psi(A_2)}$ as a new initial function,

the solution can be computed on $(\Psi(A_2), 2\Psi(A_2)) \times (A_1, A_2)$; then, by induction, it can be computed on each set $(k\Psi(A_2), (k + 1)\Psi(A_2)) \times (A_1, A_2)$ for each $k \geq 1$.

Note that the principle of integration of such equations is the same as in the case of difference equations. Thus, computing the solutions is almost a trivial task, the only not completely obvious thing being that the function defined by putting end to end the pieces corresponding to each set $(k\Psi(A_2), (k + 1)\Psi(A_2)) \times (A_1, A_2)$ verifies equation (1.3) for all $t > 0$.

In [3], [4], [5], nonlinear extensions of equation (1.3) were introduced. We will mention only one such model ([5]):

$$n(t, x) = 2\lambda\sigma(N(t - \tau)) \int_0^{+\infty} f(x, \Phi(y)) n(t - \Psi(y), y) dy, \quad (1.5)$$

where

$$N(t) = \int_0^{+\infty} \left(\int_{t-\Psi(x)}^t n(s, x) ds \right) dx, \quad (1.6)$$

$N(t)$ represents the number of cells present at time t . The expression $\lambda\sigma(N(t - \tau))$ models a control mechanism which can be interpreted as a rate of defective division. This rate is shaped by the function σ , assumed to be C^1 , and decreasing, $0 < \sigma(x) < 1$; λ is a coefficient of magnitude $0 < \lambda < 1$. As λ increases from 0 to 1, σ being unchanged, stability properties of equilibria of equation (1.5) may change. In [3], the case $\tau = 0$ was studied. It was proved that for λ less than some value, the solutions converge to zero, while, above this value, zero loses its stability and a new global equilibrium arises. In the case $\tau > 0$, the problem is far more complicated. In [5] some global results regarding the existence of slowly oscillating periodic solutions were obtained, in very restricted situations.

A reasonable conjecture is that these large oscillations are preceded by small periodic oscillations taking place in the vicinity of the nontrivial equilibrium, due to a local Hopf bifurcation.

One of the main motivations of our effort in the direction of abstract delay equations lies in the fact that we aimed at investigating the above conjecture. For this purpose, the difference equation approach is not well-suited.

1.3 From integro-difference to abstract delay differential equations ([8])

1.3.1 The linear equation. We will now derive two differential equations from equation (1.3). The first one leads to a partial differential equation with retarded arguments, a retarded version of the Lotka-Volterra equation of demography ([42]). The theory underlying such an equation is the theory of abstract delay differential equations with unbounded operators. Although it is probably the best framework in the sense that it leads to the same semigroup as equation (1.3), it involves a theory that is not available yet. The second one is a differential equation with retarded arguments and a bounded operator. It fits into the framework within which the extension of the theory of delay differential equations will be developed later ([58], [7]). The main shortcoming of the second equation is that it leads to a dynamical system much bigger than the one under study, one in which the solutions of interest determine a proper subset. However, some of the dynamical properties of the larger system also hold for the smaller one, for example, stability and bifurcation of equilibria in the larger system reflect similar properties for the smaller one. This fact amply justifies in our view the study of this system which, on the other hand, is much simpler than the smaller one.

Retarded partial differential equation formulation of equation (1.3).— Consider a solution n of equation (1.3). Assume that n can be differentiated with respect to time and size. We will use the notations $\partial_1 n$ (resp. $\partial_2 n$) to denote the function obtained by taking the partial derivative of n with respect to its first variable (resp. the second one). The computations we will perform are mostly formal. They could be justified afterwards.

Taking the derivative with respect to t on both sides of equation (1.3), we arrive at

$$\frac{\partial n}{\partial t} = 2 \int_0^{+\infty} f(x, \Phi(y)) (\partial_1 n)(t - \Psi(y), y) dy.$$

We have

$$\frac{\partial}{\partial y} [n(t - \Psi(y), y)] = -\Psi'(y) \partial_1 n(t - \Psi(y), y) + \partial_2 n(t - \Psi(y), y),$$

from which we deduce the following expression for $\partial_1 n$:

$$(\partial_1 n)(t - \Psi(y), y) = -\frac{1}{\Psi'(y)} \left[\frac{\partial}{\partial y} [n(t - \Psi(y), y)] - \partial_2 n(t - \Psi(y), y) \right].$$

Inserting the right-hand side of the above in the expression of $\partial n/\partial t$, we obtain

$$\begin{aligned} \frac{\partial n}{\partial t}(t, x) &= -2 \int_0^{+\infty} \frac{f(x, \Phi(y))}{\Psi'(y)} \frac{\partial}{\partial y} [n(t - \Psi(y), y)] dy \\ &\quad + 2 \int_0^{+\infty} \frac{f(x, \Phi(y))}{\Psi'(y)} \partial_2 n(t - \Psi(y), y) dy. \end{aligned}$$

At this point, we remind the reader that we work with functions $n(t, x)$ whose support in x is contained in $[A_1, A_2]$, that is, $n(t, x) = 0$ for $x < A_1$ or $x > A_2$.

If we assume further that

$$\frac{\partial}{\partial y} \left[\frac{f(x, \Phi(y))}{\Psi'(y)} \right] \text{ exists in } L^1((A_1, A_2)^2), \tag{1.7}$$

then we can use integration by parts on the first integral in the above expression of $\partial n/\partial t$, which yields the following

$$\begin{aligned} \frac{\partial n}{\partial t}(t, x) &= 2 \int_0^{+\infty} \frac{\partial}{\partial y} \left[\frac{f(x, \Phi(y))}{\Psi'(y)} \right] n(t - \Psi(y), y) dy \\ &\quad + 2 \int_0^{+\infty} \frac{f(x, \Phi(y))}{\Psi'(y)} \partial_2 n(t - \Psi(y), y) dy. \end{aligned} \tag{1.8}$$

If, conversely, we start from equation (1.7), and integrate it to get back to equation (1.3), then, in fact, we obtain:

$$n(t, x) - n(0, x) = 2 \int_0^{+\infty} f(x, \Phi(y)) [n(t - \Psi(y), y) - n(-\Psi(y), y)] dy.$$

So, in order to come back to equation (1.3), it is necessary to complement the partial differential equation with the boundary condition

$$n(0, x) = 2 \int_0^{+\infty} f(x, \Phi(y)) n(-\Psi(y), y) dy. \tag{1.9}$$

Equation (1.7) is a sort of functional transport equation, an extension of the Lotka-von Foerster equation for age-dependent populations ([42]), or the Bell-Anderson equation ([13]) for size-dependent cell populations. The term

$$2 \int_0^{+\infty} \frac{f(x, \Phi(y))}{\Psi'(y)} \partial_2 n(t - \Psi(y), y) dy$$

corresponds to $\partial l/\partial a(t, a)$ in the classical Sharpe-Lotka model of demography, or $\partial/\partial x (g(x)p(t, x))$ in the cell population model ([13]). The quantity

$$-2 \int_0^{+\infty} \frac{\partial}{\partial y} \left[\frac{f(x, \Phi(y))}{|\Psi'(y)|} \right] n(t - \Psi(y), y) dy$$

accounts for the mortality term.

We summarize the relationship between the integro-difference equation and the P.D.E. as follows:

Proposition 36 *Assume all the above stated conditions on f , Φ and Ψ , including condition given by formula (1.7). Then, equation (1.3) is equivalent to the system (1.7)-(1.9).*

Delay differential equation formulation of equation (1.3).– If in equation (1.3) we let $t > r$, we can express $n(t - \Psi(y), y)$ in integral form. This leads to the equation

$$n(t, x) = 4 \int_0^{+\infty} \int_0^{+\infty} f(x, \Phi(y)) f(y, \Phi(z)) n(t - \Psi(y) - \Psi(z), z) dzdy. \tag{1.10}$$

Assuming that n can be differentiated with respect to t , and taking the derivative of (1.10) on both sides, we arrive at

$$\frac{\partial n}{\partial t} = 4 \int_0^{+\infty} \int_0^{+\infty} f(x, \Phi(y)) f(y, \Phi(z)) \partial_1 n(t - \Psi(y) - \Psi(z), z) dzdy.$$

The quantity $\partial_1 n(t - \Psi(y) - \Psi(z), z)$ can be interpreted as the derivative with respect to y :

$$\partial_1 n(t - \Psi(y) - \Psi(z), z) = -\frac{1}{\Psi'(y)} \frac{\partial}{\partial y} [n(t - \Psi(y) - \Psi(z), z)].$$

Once again, integration by parts using the fact that $n(t, \cdot)$ has support in $[A_1, A_2]$, yields the desired equation:

$$\frac{\partial n}{\partial t}(t, x) = 4 \int_0^{+\infty} \int_0^{+\infty} \frac{\partial}{\partial y} \left[\frac{f(x, \Phi(y)) f(y, \Phi(z))}{\Psi'(y)} \right] n(t - \Psi(y) - \Psi(z), z) dzdy, \tag{1.11}$$

provided that we assume

$$\frac{\partial}{\partial y} \left[\frac{f(x, \Phi(y)) f(y, \Phi(z))}{\Psi'(y)} \right] \text{ exists in } L^1((A_1, A_2)^3).$$

Denoting \mathcal{L} the linear operator:

$$\mathcal{L} : C([-2r, 0]; L^1(A_1, A_2)) \longrightarrow L^1(A_1, A_2)$$

defined by the right-hand side of equation (1.11):

$$(\mathcal{L}p)(x) := 4 \int_0^{+\infty} \int_0^{+\infty} \frac{\partial}{\partial y} \left[\frac{f(x, \Phi(y)) f(y, \Phi(z))}{\Psi'(y)} \right] p(-\Psi(y) - \Psi(z), z) dzdy,$$

equation (1.11) reads

$$\frac{\partial n}{\partial t} = \mathcal{L}(n_t). \tag{1.12}$$

Equation (1.12) is an example of what we call *abstract linear delay differential equations*. If, conversely, n is a solution of (1.12), integrating the equation on both sides from 0 to t we obtain, after integration by parts:

$$\begin{aligned} n(t, x) - n(0, x) &= 4 \int_0^{+\infty} \int_0^{+\infty} f(x, \Phi(y)) f(y, \Phi(z)) n(t - \Psi(y) - \Psi(z), z) dz dy \\ &\quad - 4 \int_0^{+\infty} \int_0^{+\infty} f(x, \Phi(y)) f(y, \Phi(z)) n(-\Psi(y) - \Psi(z), z) dz dy. \end{aligned}$$

If we assume that

$$n(0, x) = 4 \int_0^{+\infty} \int_0^{+\infty} f(x, \Phi(y)) f(y, \Phi(z)) n(-\Psi(y) - \Psi(z), z) dz dy, \tag{1.13}$$

then the same equality holds for all $t > 0$, that is

$$n(t, x) = 4 \int_0^{+\infty} \int_0^{+\infty} f(x, \Phi(y)) f(y, \Phi(z)) n(t - \Psi(y) - \Psi(z), z) dz dy. \tag{1.14}$$

Equation (1.14) is strictly more general, however, than equation (1.3), and leads to a much bigger set of solutions than the one determined by (1.3).

A very partial converse result in this respect is the following: if n is a solution of equation (1.14) and, for some t_0 , n satisfies (1.3) for all t in $(t_0, t_0 + r)$, then n satisfies (1.3) for all $t > t_0$.

1.3.2 Delay differential equation formulation of system (1.5)-(1.6) .

Note that in the case of system (1.5)-(1.6), the maximum delay is $\tau + r$. If, in equation (1.5) we let $t > r$, we can express $n(t - \Psi(y), y)$ in integral form. This leads to the equation:

$$\begin{aligned} n(t, x) &= 4\lambda^2 \sigma(N(t - \tau)) \int_0^{+\infty} \int_0^{+\infty} f(x, \Phi(y)) f(y, \Phi(z)) \times \\ &\quad \times \sigma(N(t - \Psi(y) - \tau)) n(t - \Psi(y) - \Psi(z), z) dz dy \tag{1.15} \end{aligned}$$

Assuming that n can be differentiated with respect to t , and taking the derivative with respect to t on both sides of (1.14), we obtain:

$$\begin{aligned} \frac{\partial n}{\partial t}(t, x) &= \sigma'(N(t - \tau)) \dot{N}(t - \tau) \frac{n(t, x)}{\sigma(N(t - \tau))} \\ &\quad + 4\lambda^2 \sigma(N(t - \tau)) \int_0^{+\infty} \int_0^{+\infty} f(x, \Phi(y)) f(y, \Phi(z)) \times \\ &\quad \times \frac{\partial}{\partial t} [\sigma(N(t - \Psi(y) - \tau)) n(t - \Psi(y) - \Psi(z), z)] dz dy. \end{aligned} \tag{1.16}$$

We point out the fact that N can indeed be differentiated, and:

$$\dot{N}(t) = \int_0^{+\infty} [n(t, x) - n(t - \Psi(x), x)] dx. \tag{1.17}$$

We note the same property as in the previous computation:

$$\begin{aligned} \frac{\partial}{\partial t} [\sigma(N(t - \Psi(y) - \tau)) n(t - \Psi(y) - \Psi(z), z)] \\ = -\frac{1}{\Psi'(y)} \frac{\partial}{\partial y} [\sigma(N(t - \Psi(y) - \tau)) n(t - \Psi(y) - \Psi(z), z)]. \end{aligned}$$

Integration by parts with respect to y of the last integral on the right-hand side of (1.15) transforms this integral into

$$\begin{aligned} 4\lambda^2 \sigma(N(t - \tau)) \int_0^{+\infty} \int_0^{+\infty} \frac{\partial}{\partial y} \left[\frac{f(x, \Phi(y)) f(y, \Phi(z))}{\Psi'(y)} \right] \times \\ \times \sigma(N(t - \Psi(y) - \tau)) n(t - \Psi(y) - \Psi(z), z) dz dy. \end{aligned}$$

Using the above expression and formula (1.17), equation (1.15) yields the following

$$\begin{aligned} \frac{\partial n}{\partial t}(t, x) &= \frac{\sigma'(N(t - \tau))}{\sigma(N(t - \tau))} n(t, x) \int_0^{+\infty} [n(t - \tau, y) - n(t - \tau - \Psi(y), y)] dy \\ &\quad + 4\lambda^2 \sigma(N(t - \tau)) \int_0^{+\infty} \int_0^{+\infty} \frac{\partial}{\partial y} \left[\frac{f(x, \Phi(y)) f(y, \Phi(z))}{\Psi'(y)} \right] \times \\ &\quad \times \sigma(N(t - \Psi(y) - \tau)) n(t - \Psi(y) - \Psi(z), z) dz dy. \end{aligned} \tag{1.18}$$

Assume that $n(t, \cdot)$ is defined on \mathbf{R} (for example, n is a periodic solution of (1.5)). In this case, n satisfies equation (1.14). Assuming f bounded on bounded rectangles, we conclude that n is bounded and continuous on each set $[-T, T] \times \mathbf{R}^+$, ($T > 0$), which in particular implies that N is locally Lipschitz continuous. Assuming moreover that f is C^1 , it is possible to write the integral in equation (1.14) in the following way:

$$\int_{A_1}^{A_2} \int_{t-\Psi(A_2)}^{t-\Psi(A_1)} f(x, \Phi(\Psi^{-1}(t-s))) f(\Psi^{-1}(t-s), \Phi(z)) \times$$

$$\times \sigma(N(s - \tau)) n(s - \Psi(z), z) |(\Psi^{-1})'(t - s)| ds dz ,$$

which implies that n is locally Lipschitz in t , uniformly in x , in other words, there exists \mathcal{N} , a negligible set of t -values, such that $n(t, x)$ is differentiable for all t not in \mathcal{N} , and all $x \in (A_1, A_2)$. In conclusion, we have the following

Lemma 32 *If n is a solution of (1.5), defined for every t in \mathbf{R} , then n is differentiable in t with $\partial n / \partial t$ continuous in $\mathbf{R} \times \mathbf{R}$, satisfying equation (1.17).*

Equation (1.17) is a nonlinear delay differential equation on the space $L^1(A_1, A_2)$, with maximum delay equal to $2r + \tau$. As in the linear case, it is obvious, by construction, that the solutions of the system (1.5)-(1.6) are solutions of equation (1.17), but equation (1.17) has a much bigger set of solutions than system (1.5)-(1.6). The motivation for embedding the latter system into a bigger one is that the framework of differential equations seems to be more suited to the study of dynamical features such as stability than the framework of integral equations.

1.4 The linearized equation of equation (1.17) near nontrivial steady-states

Equation (1.17) is the most complete of all the equations considered here. It can be reduced to equation (1.11) by assuming that $2\lambda\sigma(N) = 1$. If the delay $\tau = 0$, we obtain the equation studied in [3]. Our program regarding equation (1.17) is to start from the steady-states and investigate their stability and the loss of stability in terms of λ . While we already know from [3] that stability passes from a constant steady-state to another one when $\tau = 0$, we expect that in the delay case stable oscillations may take place. This fact has been shown under several restrictions in [5]: existence of periodic slowly oscillating solutions has been demonstrated for a range of values of the parameters. However, the result is not explicitly related to any bifurcation of steady-state periodic solution. We believe however that there is a strong possibility that such a bifurcation occurs at these values of λ where some eigenvalues of the linearized equation cross the imaginary axis (away from zero).

1.4.1 The steady-state equation. Note that any function $\bar{n}(x)$ of x only verifies equation (1.17) trivially. If $n = \bar{n}$, we have

$$N(t) = \bar{N} = \int_0^{+\infty} \Psi(x) \bar{n}(x) dx.$$

From them we will only retain those which are non-negative solutions of the system (1.5)-(1.6). Equation (1.5) leads to

$$\bar{n}(x) = 2\lambda\sigma(\bar{N}) \int_0^{+\infty} f(x, \Phi(y)) \bar{n}(y) dy.$$

Integrating the above equation on both sides and using the fact that $f(\cdot, \Phi(y))$ is a probability density, we obtain

$$2\lambda\sigma(\bar{N}) = 1$$

and

$$\bar{n}(x) = \int_0^{+\infty} f(x, \Phi(y)) \bar{n}(y) dy. \tag{1.19}$$

Equation (1.19) is, notably, dealt with in detail in [2]. It is a typical example of application of the Perron-Frobenius theory of positive operators on ordered Banach spaces.

Equation (1.19) has a unique positive solution n_1 such that $\int_0^{+\infty} n_1(x) dx = 1$. In terms of n_1 , $\bar{n} = kn_1$, where k is a constant. The constant k satisfies the relation

$$2\lambda\sigma \left(k \int_0^{+\infty} \Psi(x)n_1(x) dx \right) = 1. \tag{1.20}$$

Assuming that

$$\sigma(0) > \frac{1}{2} \quad ; \quad \sigma(+\infty) = 0,$$

equation (1.20) has, for each $\lambda > \frac{1}{2\sigma(0)}$, one and only one root $k = k(\lambda)$.

The function k is increasing.

1.4.2 Linearization of equation (1.17) near (\bar{n}, \bar{N}) .

The linearization is obtained by formally differentiating equation (1.17) with respect to every occurrence of n as if it were an independent variable and multiplying the result by the same occurrence of the variation Δn . This yields the following:

$$\begin{aligned} \frac{\partial}{\partial t}(\Delta n)(t, x) &= \frac{\sigma'(\bar{N})}{\sigma(\bar{N})} \bar{n}(x) \int_0^{+\infty} [(\Delta n)(t - \tau, y) - (\Delta n)(t - \tau - \Psi(y), y)] dy \\ &+ 4\lambda^2 \sigma(\bar{N}) \int_0^{+\infty} \int_0^{+\infty} \frac{\partial}{\partial y} \left[\frac{f(x, \Phi(y)) f(y, \Phi(z))}{\Psi'(y)} \right] \times \\ &\times [\sigma'(\bar{N}) \Delta N(t - \Psi(y) - \tau) \bar{n}(z) \\ &+ \sigma(\bar{N}) \Delta n(t - \Psi(y) - \Psi(z), z)] dz dy. \end{aligned}$$

The equation can be simplified a little bit. In view of relation (1.19), we have

$$\int_0^{+\infty} \int_0^{+\infty} \frac{\partial}{\partial y} \left[\frac{f(x, \Phi(y)) f(y, \Phi(z))}{\Psi'(y)} \right] \bar{n}(z) dz dy = \int_0^{+\infty} \frac{\partial}{\partial y} \left[\frac{f(x, \Phi(y)) \bar{n}(y)}{\Psi'(y)} \right] dy.$$

This, in turn, leads to

$$\begin{aligned} & \int_0^{+\infty} \int_0^{+\infty} \frac{\partial}{\partial y} \left[\frac{f(x, \Phi(y)) f(y, \Phi(z))}{\Psi'(y)} \right] \Delta N(t - \Psi(y) - \tau) \bar{n}(z) dz dy \\ &= \int_0^{+\infty} \frac{\partial}{\partial y} \left[\frac{f(x, \Phi(y)) \bar{n}(y)}{\Psi'(y)} \right] \Delta N(t - \Psi(y) - \tau) dy \\ &= \int_0^{+\infty} f(x, \Phi(y)) \bar{n}(y) \partial_1(\Delta N)(t - \Psi(y) - \tau) dy \\ &= \int_0^{+\infty} f(x, \Phi(y)) \bar{n}(y) \times \\ & \quad \times \left[\int_0^{+\infty} [(\Delta n)(t - \Psi(y) - \tau, z) - (\Delta n)(t - \Psi(y) - \Psi(z) - \tau, z)] dz \right] dy. \end{aligned}$$

We arrive at the following equation

$$\begin{aligned} \frac{\partial}{\partial t}(\Delta n)(t, x) &= \frac{\sigma'(\bar{N})}{\sigma(\bar{N})} \bar{n}(x) \int_0^{+\infty} [(\Delta n)(t - \tau, y) - (\Delta n)(t - \tau - \Psi(y), y)] dy \\ &+ 2\lambda\sigma'(\bar{N}) \int_0^{+\infty} f(x, \Phi(y)) \bar{n}(y) \times \\ & \quad \times \left[\int_0^{+\infty} [(\Delta n)(t - \Psi(y) - \tau, z) - (\Delta n)(t - \Psi(y) - \Psi(z) - \tau, z)] dz \right] dy \\ &+ \int_0^{+\infty} \int_0^{+\infty} \frac{\partial}{\partial y} \left[\frac{f(x, \Phi(y)) f(y, \Phi(z))}{\Psi'(y)} \right] (\Delta n)(t - \Psi(y) - \Psi(z), z) dz dy. \end{aligned} \tag{1.21}$$

1.4.3 Exponential solutions of (1.20) . The study of the stability of \bar{n} as a solution of equation (1.17) amounts to the study of the growth rate of the semigroup associated to equation (1.20). In the case of a compact or eventually compact semigroup, this amounts to determining exponential solutions $(\exp zt)x$. Then, the growth rate is negative if $\sup \operatorname{Re} z < 0$, and it is positive if $\sup \operatorname{Re} z > 0$. Bifurcation of equilibria occurs at the values of parameters where the growth rate changes signs. It can be shown that the semigroup associated to equation (1.20) is not eventually compact, but its restriction to the elements of

$C([-r, 0]; X)$ satisfying (1.13) is. This remark motivates the study of exponential solutions of equation (1.20).

Let $\nu(t, x) = e^{zt}p(x)$ be a solution of equation (1.20). Substituting $e^{zt}p(x)$ for Δn in (1.20) yields

$$\begin{aligned}
 zp(x) &= e^{-z\tau} \frac{\sigma'(\bar{N})}{\sigma(\bar{N})} \bar{n}(x) \int_{A_1}^{A_2} (1 - e^{-z\Psi(y)}) p(y) dy \\
 &\quad + 2\lambda\sigma'(\bar{N}) \int_{A_1}^{A_2} f(x, \Phi(y)) \bar{n}(y) \times \\
 &\quad \times \left[\int_{A_1}^{A_2} e^{-z(\Psi(y)+\tau)} (1 - e^{-z\Psi(u)}) p(u) du \right] dy \\
 &\quad + \int_{A_1}^{A_2} \int_{A_1}^{A_2} \frac{\partial}{\partial y} \left[\frac{f(x, \Phi(y)) f(y, \Phi(u))}{\Psi'(y)} \right] e^{-z(\Psi(y)+\Psi(u))} p(u) du dy.
 \end{aligned}
 \tag{1.22}$$

To abbreviate, we will call such an equation a spectral equation. Note that the right-hand side of the above equation vanishes for $z = 0$. For this value of z , every function p satisfies the equation. Equation (1.21) is quite complicated. We will not study it directly. Instead, we will now introduce the eigenvalue equation associated with the linearization of equation (1.5). Then, we will show that both equations are partially equivalent to each other.

Ideally, one could expect that this part of the spectrum is the part brought up by the passage from the integral to the differential formulation, and the remaining part of the spectrum reflects the spectrum of the integral equation only. The spectral equation associated to the linearization of equation (1.5) near \bar{n} is

$$\begin{aligned}
 p(x) &= e^{-z\tau} 2\lambda\sigma'(\bar{N}) \left(\int_{A_1}^{A_2} p(y) \left(\frac{1 - e^{-z\Psi(y)}}{z} \right) dy \right) \bar{n}(x) \\
 &\quad + \int_{A_1}^{A_2} f(x, \Phi(y)) e^{-z\Psi(y)} p(y) dy.
 \end{aligned}
 \tag{1.23}$$

One can easily verify that every solution of equation (1.22) is also a solution of equation (1.21). In the following Lemma, we state a partial converse of this result.

Lemma 33 *Denote σ_1 (resp. σ_2) the set of complex numbers $z, z \neq 0, \operatorname{Re} z \geq 0$, such that equation (1.21) (resp.) (1.22) has a nonzero solution for the value z . Then, $\sigma_1 = \sigma_2$.*

Moreover, for each $z \in \sigma_i$, let \mathcal{N}_z^i ($i = 1, 2$) be the space of functions p such that p is a solution of (1.21) (resp. (1.22)) for the value z . Then, $\mathcal{N}_z^1 = \mathcal{N}_z^2$.

Proof.— For each $z \neq 0$, we introduce the operators

$$\mathcal{B}_z(p) := 2\lambda\sigma'(\bar{N}) \int_{A_1}^{A_2} p(y) \left[\frac{1 - e^{-z\Psi(y)}}{z} \right] dy,$$

$$(\mathcal{L}_z p)(x) := \int_{A_1}^{A_2} f(x, \Phi(y)) e^{-z\Psi(y)} p(y) dy.$$

Then equation (1.22) is

$$p(x) = e^{-z\tau} \bar{n}(x) \mathcal{B}_z(p) + (\mathcal{L}_z p)(x),$$

and equation (1.21) reads

$$p(x) = e^{-z\tau} \bar{n}(x) \mathcal{B}_z(p) + (\mathcal{L}_z q)(x),$$

where

$$q(x) = e^{-z\tau} \bar{n}(x) \mathcal{B}_z(p) + (\mathcal{L}_z p)(x).$$

We need only prove that p , a solution of (1.21) for some $z \neq 0$, with $\text{Re } z \geq 0$, satisfies (1.22) for the same value of z . But this is equivalent to proving $p = q$. Since we have

$$p(x) - q(x) = (\mathcal{L}_z(p - q))(x),$$

and the equation

$$p(x) = (\mathcal{L}_z p)(x)$$

can be satisfied with $p \neq 0$ only if $\text{Re } z < 0$, the Lemma follows.

We will now briefly discuss equation (1.22).

For $z = 0$, equation (1.22) reduces to

$$\begin{aligned} p(x) &= 2\lambda\sigma'(\bar{N}) \left(\int_{A_1}^{A_2} p(y) \Psi(y) dy \right) \bar{n}(x) \\ &\quad + \int_{A_1}^{A_2} f(x, \Phi(y)) p(y) dy, \end{aligned}$$

which has $p = 0$ as the only solution.

In fact, integrating the above equation on both sides on (A_1, A_2) , we obtain

$$2\lambda\sigma'(\bar{N}) \left(\int_{A_1}^{A_2} p(y) \Psi(y) dy \right) = 0,$$

which implies that

$$p(x) = \int_{A_1}^{A_2} f(x, \Phi(y)) p(y) dy,$$

and therefore, in view of (1.19):

$$p(x) = k\bar{n}(x).$$

So,

$$0 = \int_{A_1}^{A_2} p(y)\Psi(y) dy = k \int_{A_1}^{A_2} \bar{n}(y)\Psi(y) dy.$$

This, with the fact $\bar{n} > 0$, implies that $k = 0$, that is $p = 0$.

For $z \neq 0$, integrating equation (1.22) on both sides on (A_1, A_2) , we obtain

$$\left[\int_{A_1}^{A_2} p(y) \left(1 - e^{-z\Psi(y)}\right) dy \right] \left[2\lambda\sigma'(\bar{N})e^{-z\tau} \left(\int_{A_1}^{A_2} \bar{n}(y) dy \right) - z \right] = 0. \quad (1.24)$$

Equation (1.24) breaks down into two equations

$$\int_{A_1}^{A_2} p(y) \left(1 - e^{-z\Psi(y)}\right) dy = 0, \quad (1.25)$$

$$ze^{z\tau} = 2\lambda\sigma'(\bar{N}) \int_{A_1}^{A_2} \bar{n}(y) dy. \quad (1.26)$$

Assuming (1.25) holds, equation (1.22) yields, with $z \neq 0$:

$$p(x) = \int_{A_1}^{A_2} f(x, \Phi(y)) e^{-z\Psi(y)} p(y) dy,$$

which can be satisfied with $p \neq 0$ only if $\operatorname{Re} z < 0$.

So, instability from nonzero roots crossing the imaginary axis can only come from roots of equation (1.26). We have the following result:

For each $\lambda > 0$, equation (1.24) has a pair of nonzero roots crossing the imaginary axis at each value $\tau = \tau_k$, where

$$\tau_k = \frac{\pi/2 + 2k\pi}{2\lambda|\sigma'(\bar{N})| \int_{A_1}^{A_2} \bar{n}(y) dy}, \quad k \in \mathbf{N}.$$

Once equation (1.24) has been solved for $z \neq 0$, in order to have a full solution of equation (1.21), it remains to solve equation (1.22) for p .

The equation can be written in the form

$$(I - \mathcal{K})p = 0,$$

where \mathcal{K} is a compact operator. The fact that

$$\int_{A_1}^{A_2} ([I - \mathcal{K}]p)(x) dx = 0$$

for every $p \in X$, implies that $\text{Im}(I - \mathcal{K})$ is a proper subspace of X , and therefore, by virtue of a well known property of compact operators, the null set of $I - \mathcal{K}$ is not reduced to 0.

1.5 Conclusion

The construction of a theory of delay differential equations in infinite dimensional spaces is motivated by the study of some integro-difference equations arising in some models of cell population dynamics. The introduction of a nonlinearity in these models to account for possible self-regulating control mechanism of cell number suggested possible oscillations. The integro-difference nature of the model did not allow the use of any known standard techniques to exhibit such oscillations. The observation that was made that this system (and its solutions) can in fact be viewed as solutions of a larger system of delay differential equations in an infinite dimensional space led to the idea to extend this frame the machinery for the study of stability that has been developed for delay differential equations in finite dimensional spaces.

Let us conclude with a few comments about oscillations. Oscillation with respect to time of the number of cells is a recognized fact in several examples, among which is the production of red blood cells ([4], [17]). This phenomenon can also be observed in cultured cells. It used to be a common belief that such oscillations reflect the role of delays at various stages of the life of cells. A lot of efforts were made during the seventies in the study of homogeneous nonstructured models with the goals of first proving existence of periodic oscillations, after that counting them and looking at their stability and other properties. Amongst those who contributed to these works let us mention [12], [22] and [41]. In contrast to this, very little has been done in the case of structured models. One of the reasons is that there is no general theory for the study of dynamical properties of such equations. The theory on abstract D.D.E. that we present here is a step in this direction.

2. The Cauchy Problem For An Abstract Linear Delay Differential Equation

Our interest in functional differential equations in infinite dimensions stemmed from the study of the dynamical properties of such equations

and the remark we made at some point that it is possible to associate to any of them a delay differential equation on an infinite dimensional vector space. We start with this theory for the linear and autonomous case and this section is devoted to the resolution of the Cauchy problem.

We start setting up the general framework of the equations under study. The notation \mathcal{C} stands for the space $C([-r, 0]; E)$ ($r > 0$) of the continuous functions from the interval $[-r, 0]$ into E , E being a real Banach space, endowed with the sup norm

$$\|\varphi\|_{\mathcal{C}} := \sup_{\theta \in [-r, 0]} \|\varphi(\theta)\|_E.$$

Let $L : \mathcal{C} \rightarrow E$ be a bounded linear operator. We are considering the following Cauchy problem for the delay equation defined by the operator L :

For each $\varphi \in \mathcal{C}$, to find a function $x \in C([-r, +\infty[; E)$, $x \in C^1([0, +\infty[; E)$ such that the following relations hold

$$(CP) \quad \begin{cases} x'(t) &= L(x_t), \text{ for all } t > 0 \\ x_0 &= \varphi \end{cases}$$

As usual, x_t denotes the section at t of the function x , namely $x_t(\theta) := x(t + \theta)$, $\theta \in [-r, 0]$. The Cauchy problem is *well-posed* if it has one and only one solution for each initial value φ .

2.1 Resolution of the Cauchy problem

There are several ways to solve problem (CP). The most elementary one is to write the equation in integral form

$$x(t) = x(0) + \int_0^t L(x_s) ds, \quad t > 0. \quad (2.1)$$

Define the function $\varphi^0 : [-r, +\infty[\rightarrow E$ by

$$\varphi^0(t) := \begin{cases} \varphi(t) & \text{if } t \in [-r, 0] \\ \varphi(0) & \text{if } t \geq 0. \end{cases}$$

The change of x by the unknown function

$$y(t) := x(t) - \varphi^0(t)$$

transforms equation (2.1) into

$$y(t) = \int_0^t L(y_s) ds + \int_0^t L(\varphi_s^0) ds \quad (2.2)$$

which can be formulated as an abstract equation in a suitable framework. To this end, for each $\alpha > 0$ let us define

$$\mathcal{E}_0^\alpha := \{y \in C([0, +\infty); E) ; y(0) = 0, \|y\|_\alpha := \sup_{t \geq 0} e^{-\alpha t} \|y(t)\|_E < +\infty\}$$

which is a Banach space with respect to the norm $\|\cdot\|_\alpha$.

Let Q be the bounded linear operator defined by

$$Q : \mathcal{E}_\alpha^0 \longrightarrow \mathcal{E}_\alpha^0 \quad ; \quad (Qy)(t) := \int_0^t L(\tilde{y}_s) ds$$

where \tilde{y} is the extension by zero of function y to $[-r, 0]$. In terms of this operator, equation (2.2) reads as:

$$(\text{Id} - Q)(y)(t) = \int_0^t L(\varphi_s^0) ds.$$

The norm of Q on \mathcal{E}_0^α satisfies the following estimate

$$\|Qy\|_\alpha \leq \frac{\|L\|}{\alpha} \|y\|_\alpha$$

so, for $\alpha > \|L\|$, Q is a strict contraction. This implies that equation (2.1) has one and only one solution defined on $[-r, +\infty[$. This proves that the Cauchy problem (CP) is well-posed.

As usual, bearing in mind that the initial state is the function φ and the state at time t is the function x_t , we introduce the *solution operator* $T(t)$ defined by

$$T(t)\varphi := x_t \quad , \quad t > 0.$$

It is easy to check that the family $\{T(t)\}_{t \geq 0}$ is a strongly continuous semigroup of linear bounded operators on \mathcal{C} . An obvious property of this semigroup is that

$$[T(t)\varphi](\theta) = \begin{cases} \varphi(t + \theta) & \text{if } t + \theta \leq 0 \\ [T(t + \theta)\varphi](0) & \text{if } t + \theta \geq 0 \end{cases}$$

that is, $\{T(t)\}_{t \geq 0}$ is a *translation semigroup*.

Straightforward computation leads to the following operator as the *infinitesimal generator* of the semigroup:

$$A\varphi := \dot{\varphi} \tag{2.3}$$

with domain

$$D(A) = \{\varphi \in C^1([-r, 0]; E) ; \dot{\varphi}(0) = L(\varphi)\}. \tag{2.4}$$

2.2 Semigroup approach to the problem (CP)

Semigroups defined on some functional space of the type $\mathcal{F}(J; E)$, where J is an interval and \mathcal{F} is some class of functions (continuous functions, L^p functions, etc) and with infinitesimal generator A defined by the derivative on J , have been investigated by several authors after a pioneering work by A. Plant [34]. Extension of Plant's results to abstract delay differential equations can be found in [16] and in [73]. The following result is borrowed from [73].

Theorem 1 *The operator A defined by (2.3) with domain given by (2.4) is the infinitesimal generator of a strongly continuous semigroup $\{S(t)\}_{t \geq 0}$ on \mathcal{C} satisfying the translation property*

$$(S(t)\varphi)(\theta) = \begin{cases} \varphi(t + \theta) & \text{if } t + \theta \leq 0 \\ (S(t + \theta)\varphi)(0) & \text{if } t + \theta > 0 \end{cases}$$

$t > 0$, $\theta \in [-r, 0]$, $\varphi \in \mathcal{C}$. Furthermore, for each $\varphi \in \mathcal{C}$, define $x : [-r, +\infty) \rightarrow E$ by

$$x(t) := \begin{cases} \varphi(t) & \text{if } t \in [-r, 0] \\ (S(t)\varphi)(0) & \text{if } t > 0. \end{cases}$$

Then x is the unique solution of (CP) and $S(t)\varphi = x_t$, $t > 0$.

Remark 1.— The last part of the theorem states that in fact $S(t) = T(t)$, $t \geq 0$, which we can assert as soon as we know that $\{S(t)\}_{t \geq 0}$ and $\{T(t)\}_{t \geq 0}$ are both associated with the same infinitesimal generator.

Proof.— In order to illustrate the type of computations and ideas involved in delay equations, we will briefly sketch the proof of the theorem.

First of all, we will check that A is the infinitesimal generator of a strongly continuous semigroup. Using the Lumer-Phillips version of the Hille-Yosida theorem, we have to prove that:

- i) A is a closed operator with a dense domain.
- ii) The resolvent operator

$$R(\lambda, A) := (\lambda I - A)^{-1}$$

exists, for all real λ large enough and there exists a real constant ω such that

$$\|(\lambda I - A)^{-1}\| \leq \frac{1}{\lambda - \omega} \quad ; \quad \lambda > \omega.$$

We skip (i), which is obvious. In order to prove (ii), given $f \in \mathcal{C}$ we have to solve

$$(\lambda I - A)\varphi = f \quad ; \quad \varphi \in D(A). \tag{2.5}$$

The resolution of (2.5), which is straightforward, leads to

$$\varphi(\theta) = e^{\lambda\theta}\varphi(0) + \int_{\theta}^0 e^{\lambda(\theta-s)}f(s) ds. \tag{2.6}$$

In order to verify that $\varphi \in D(A)$, we have to check the boundary condition for φ :

$$\lambda\varphi(0) - f(0) = L \left(e^{\lambda\cdot}\varphi(0) + \int_{\cdot}^0 e^{\lambda(\cdot-s)}f(s) ds \right). \tag{2.7}$$

Let us introduce the following bounded linear operators

$$L_{\lambda} : E \longrightarrow E \quad ; \quad L_{\lambda}(z) := L(\varepsilon_{\lambda} \otimes z)$$

where $\varepsilon_{\lambda} \otimes z \in C([-r, 0]; E)$ is defined by

$$(\varepsilon_{\lambda} \otimes z)(\theta) := e^{\lambda\theta}z \quad , \quad \theta \in [-r, 0]$$

and $S_{\lambda} : \mathcal{C} \longrightarrow E$ defined by

$$S_{\lambda}(f) = f(0) + L \left(\int_{\cdot}^0 e^{\lambda(\cdot-s)}f(s) ds \right). \tag{2.8}$$

Lemma 34 *For each $\lambda \in \mathbf{C}$, the operator S_{λ} is onto.*

Proof.–

Let us consider the family of bounded linear operators $\{\Sigma_{\lambda,k}\}_{k=1,2,\dots} \subset \mathcal{L}(E)$ defined by

$$\Sigma_{\lambda,k}(z) := S_{\lambda}(\chi_k \otimes z)$$

where

$$(\chi_k \otimes z)(\theta) := \chi_k(\theta)z \quad , \quad \theta \in [-r, 0]$$

and $\{\chi_k\}_{k=1,2,\dots}$ is the family of real functions defined by

$$\chi_k(\theta) := \max \left(\frac{k\theta}{r} + 1, 0 \right) \quad , \quad \theta \in [-r, 0].$$

It is easily seen that for each λ , the sequence of operators $\Sigma_{\lambda,k}$ converges in operator norm towards the identity. Therefore $\Sigma_{\lambda,k}$ is invertible for k large enough.

In terms of $\Sigma_{\lambda,k}$, we can build a right inverse of S_λ . To this end, let us define $\Upsilon_{\lambda,k} \in \mathcal{L}(E, \mathcal{C})$ by

$$\forall b \in E \quad , \quad \Upsilon_{\lambda,k}(b) := \chi_k \otimes \Sigma_{\lambda,k}^{-1}(b). \tag{2.9}$$

It holds that

$$S_\lambda \circ \Upsilon_{\lambda,k} = I_E$$

where I_E is the identity operator on E . This proves our claim.

In terms of operators L_λ and S_λ , we have the following characterization for λ to belong in the resolvent set of the operator A :

Proposition 37 *A necessary and sufficient condition for $\lambda \in \rho(A)$ (resolvent set of A) is that the operator $\Delta(\lambda)$ defined by*

$$\Delta(\lambda) := \lambda I - L_\lambda$$

be invertible. Assuming that $\lambda \in \rho(A)$, it holds that

$$\varphi(0) = \Delta(\lambda)^{-1} S_\lambda(f)$$

and, for $\theta \in [-r, 0]$:

$$R(\lambda, A)(f)(\theta) = e^{\lambda\theta} \Delta(\lambda)^{-1} S_\lambda(f) + \int_\theta^0 e^{\lambda(\theta-s)} f(s) ds. \tag{2.10}$$

To complete the proof of the first part of the theorem it only remains to obtain a convenient estimate for the norm of $R(\lambda, A)$.

Straightforward computation shows that the operator L_λ is uniformly bounded on each right half-plane of \mathbf{C} (that is, on any set of the type $\Omega_a := \{z \in \mathbf{C} ; \operatorname{Re} z \geq a\}$ for some a). So, there exists $a_0 \in \mathbf{R}$ such that $\Delta(\lambda)$ is invertible all over regions of the complex plane Ω_a with $a \geq a_0$.

Let us define

$$M := \sup_{\operatorname{Re} \lambda \geq a_0} \|L_\lambda\|.$$

For any $a \geq a_0$, we have

$$\operatorname{Re} \lambda \geq a \implies \|L_\lambda\| \leq M.$$

So, if we take $a > 0$ and $a \geq a_0$ large enough, we will have

$$\lambda \geq a \implies \frac{\|L_\lambda\|}{\lambda} < 1$$

and then

$$\|\Delta(\lambda)^{-1}\| \leq \frac{1}{\lambda - M}.$$

We can also readily check the following estimate for $S_\lambda(f)$

$$\|S_\lambda(f)\| \leq \left(1 + \frac{\|L\|}{\lambda}\right) \|f\|_C.$$

Combining these estimates in formula (2.10) we obtain, for $\theta \in [-r, 0]$:

$$\|[R(\lambda, A)f](\theta)\|_E \leq \left[e^{\lambda\theta} \left(1 + \frac{\|L\|}{\lambda}\right) \frac{1}{\lambda - M} + (1 - e^{\lambda\theta}) \frac{1}{\lambda} \right] \|f\|_C.$$

Since the quantity inside brackets is a convex combination of two fixed values, it is bounded by the maximum of both quantities, from which we deduce

$$\|R(\lambda, A)\| \leq \max \left(\left[1 + \frac{\|L\|}{\lambda}\right] \frac{1}{\lambda - M}, \frac{1}{\lambda} \right).$$

To conclude, if we choose ω so that

$$\omega > \max(a_0, \|L\| + M)$$

we will have the desired inequality:

$$\|R(\lambda, A)\| \leq \frac{1}{\lambda - \omega} \quad \text{for } \lambda > \omega.$$

Translation semigroup property.– It remains to check that the semigroup $\{S(t)\}_{t \geq 0}$ enjoys the translation property. To this end, for each φ given in \mathcal{C} , let us define the function

$$x(t) = \begin{cases} [S(t)\varphi](0) & \text{if } t \geq 0 \\ \varphi(t) & \text{if } t \in [-r, 0] \end{cases}$$

What we have to verify is that

$$S(t)\varphi = x_t \quad , \quad t \geq 0.$$

Note that the evaluation map $\varphi \rightarrow [S(t)\varphi](0)$ is continuous and even locally uniformly continuous with respect to t , so the map $\varphi \rightarrow x_t$ is continuous for each $t \geq 0$, and in fact it is also locally uniformly continuous with respect to t . From this remark it follows that we only have to prove the property on a dense subset of initial values. It will extend by continuity to all initial values.

So, from this point on, we assume that $\varphi \in D(A)$. Then, a basic semigroup property ensures that $S(t)\varphi \in D(A)$ for all $t \geq 0$. Therefore

we have that both $t \rightarrow [S(t)\varphi](\theta)$ and $\theta \rightarrow [S(t)\varphi](\theta)$ are differentiable. Given a pair (t, θ) , $t \geq 0$, $\theta \in [-r, 0]$, the function

$$h \rightarrow [S(t+h)\varphi](\theta-h)$$

makes sense as long as $t+h \geq 0$ and $\theta-h \leq 0$, that is, $h \geq \max(-t, \theta)$ and can be differentiated on this domain. The derivative is equal to

$$\left[\frac{d}{dt} S(t+h)\varphi \right](\theta-h) - \frac{d}{d\theta} [S(t+h)\varphi](\theta-h) = 0.$$

This implies that $[S(t+h)\varphi](\theta-h)$ is a constant for each fixed pair (t, θ) and $h \geq \max(-t, \theta)$.

We now consider two situations:

i) $t + \theta \leq 0$.

In this case, $\max(-t, \theta) = -t$. Giving h the values $-t$ and 0 , we obtain

$$[S(t)\varphi](\theta) = \varphi(t+\theta) \quad \text{for } t+\theta \leq 0.$$

ii) $t + \theta \geq 0$.

This time, we give h the values θ and 0 , which leads to

$$[S(t)\varphi](\theta) = [S(t+\theta)\varphi](0) \quad \text{for } t+\theta \geq 0.$$

In both cases, we have $[S(t)\varphi](\theta) = x(t+\theta)$, according to the definition of x , therefore, $S(t)\varphi = x_t$, as desired.

2.3 Some results about the range of $\lambda I - A$

In line with Proposition 37, we have the following results.

Lemma 35 *For any $\lambda \in C$, we have that $f \in \mathcal{R}(\lambda I - A)$ if and only if $S_\lambda(f) \in \mathcal{R}(\lambda I - L_\lambda)$.*

Proof.— It follows immediately from (2.6) and (2.7) combined. Formula (2.6) shows that the determination of φ such that $(\lambda I - A)\varphi = f$ amounts to determining $\varphi(0)$ and formula (2.7) gives a necessary and sufficient condition for existence of $\varphi(0)$ which is precisely the condition stated in the lemma.

Lemma 36 *The subspace $\mathcal{R}(\lambda I - A)$ is closed in C if and only if the subspace $\mathcal{R}(\lambda I - L_\lambda)$ is closed in E .*

Proof.— First we suppose that $\mathcal{R}(\lambda I - L_\lambda)$ is a closed subspace of E and let $\{\psi_n\}_{n=1,2,\dots} \subset \mathcal{R}(\lambda I - A)$ be a convergent sequence with $\psi = \lim_{n \rightarrow \infty} \psi_n$.

From Lemma 35, we have that $S_\lambda(\psi_n) \in \mathcal{R}(\lambda I - L_\lambda)$ and then $S_\lambda(\psi) \in \mathcal{R}(\lambda I - L_\lambda)$. Again Lemma 35 enables us to conclude that $\psi \in \mathcal{R}(\lambda I - A)$ and so $\mathcal{R}(\lambda I - A)$ is closed in \mathcal{C} .

Now we are going to demonstrate the converse. We assume that $\mathcal{R}(\lambda I - A)$ is closed and we want to show that it implies that $\mathcal{R}(\lambda I - L_\lambda)$ is closed.

To this end, we recall that S_λ is surjective and that in Lemma 34 we have exhibited a family of right inverses. Select one such map $\Upsilon_{\lambda,k}$ as defined by (2.9).

Let $\{b_n\}_{n=1,2,\dots}$ be a sequence in E such that the sequence $\{(\lambda I - L_\lambda)(b_n)\}_{n=1,2,\dots}$ converges to some element $e \in E$. Define the sequence

$$f_n := \Upsilon_{\lambda,k} [(\lambda I - L_\lambda)(b_n)] \quad , \quad n = 1, 2, \dots$$

By construction, we have $S_\lambda(f_n) \in \mathcal{R}(\lambda I - L_\lambda)$. Therefore, in view of Lemma 35, we have $f_n \in \mathcal{R}(\lambda I - A)$ and $S_\lambda(f_n) = (\lambda I - L_\lambda)(b_n)$. We have also

$$\lim_{n \rightarrow \infty} S_\lambda(f_n) = e \quad ; \quad \lim_{n \rightarrow \infty} f_n = \Upsilon_{\lambda,k}(e).$$

$\mathcal{R}(\lambda I - A)$ being closed yields that $\Upsilon_{\lambda,k}(e) \in \mathcal{R}(\lambda I - A)$. Lemma 35 again can be invoked to conclude that $e = S_\lambda[\Upsilon_{\lambda,k}(e)] \in \mathcal{R}(\lambda I - L_\lambda)$. The proof is complete.

3. Formal Duality

In this section we present an extension of the formal duality theory to D.D.E. in infinite dimensional spaces. The presentation follows the work made in [58].

Let us consider the space $\mathcal{C}^* := C([0, r]; E^*)$ where E^* is the topological dual space of E . We are going to define a continuous bilinear form denoted $\langle\langle \alpha, \varphi \rangle\rangle$ on the product $C([0, r]; E^*) \times C([-r, 0]; E)$ which will be interpreted as a *formal duality*.

A function $f : [0, r] \rightarrow E^*$ is called *simple* if there exist two finite collections $x_1^*, \dots, x_p^* \in E^*$ and $A_1, \dots, A_p \in \Sigma$ with $\bigcup_{i=1}^p A_i = [0, r]$, $A_i \cap A_j = \emptyset$ such that

$$f = \sum_{i=1}^p x_i^* \chi_{A_i}$$

where χ_A is the characteristic function of A and Σ is the Borel algebra on $[0, r]$. Denote $S([0, r]; E^*)$ the space of simple functions.

Definition 37 For any $\alpha \in S([0, r]; E^*)$ and $\varphi \in C([0, r]; E)$ we define the bilinear form

$$\langle\langle \alpha, \varphi \rangle\rangle := \langle \alpha(0), \varphi(0) \rangle + \sum_{i=1}^p \langle x_i^*, L \left(\int_{\theta}^0 \chi_{A_i}(\xi - \theta) \varphi(\xi) d\xi \right) \rangle$$

where $\alpha = \sum_{i=1}^p x_i^* \chi_{A_i}$ and $\langle \cdot, \cdot \rangle$ denote the usual duality between E^* and E .

The value $\langle\langle \alpha, \varphi \rangle\rangle$ is independent of the representation chosen for α as a linear combination of characteristic functions.

Since

$$|\langle\langle \alpha, \varphi \rangle\rangle| \leq (1 + r\|L\|) \|\alpha\| \|\varphi\|$$

there exists a unique continuous extension of this bilinear form to the completion of $S([0, r]; E^*) \times C([-r, 0]; E)$ where both spaces are equipped with the sup norm.

We restrict our extension to the product $C([0, r]; E^*) \times C([-r, 0]; E)$ and we call this the *formal duality* associated with the operator L .

It is interesting to specify the formal duality for $\alpha \in C([0, r]) \otimes E^*$.

Lemma 37 Let $f \in C([0, r])$ and $u^* \in E^*$. We consider the function $f \otimes u^* \in C([0, r]; E^*)$ defined by $(f \otimes u^*)(s) := f(s)u^*$, $s \in [0, r]$. Then

$$\langle\langle f \otimes u^*, \varphi \rangle\rangle = \langle u^*, f(0)\varphi(0) \rangle + \langle u^*, L \left(\int_{\theta}^0 f(\xi - \theta)\varphi(\xi) d\xi \right) \rangle. \tag{3.1}$$

Proof.— The function f is representable as the limit of a uniformly convergent sequence of simple real functions defined in $[0, r]$:

$$f = \lim_{n \rightarrow \infty} \sum_{i=1}^{p_n} \beta_i^{(n)} \chi_{A_i^{(n)}}$$

and therefore the sequence of functions in $S([0, r]; E^*)$,

$$\left\{ \sum_{i=1}^{p_n} \beta_i^{(n)} u^* \otimes \chi_{A_i^{(n)}} \right\}_{n=1,2,\dots}$$

converges to $f \otimes u^*$.

By continuity of the formal duality, we obtain

$$\begin{aligned} & \ll f \otimes u^*, \varphi \gg \\ & = \langle (f \otimes u^*)(0), \varphi(0) \rangle + \lim_{n \rightarrow \infty} \sum_{i=1}^{p_n} \langle \beta_i^{(n)} u^*, L \left(\int_{\theta}^0 \chi_{A_i^{(n)}}(\xi - \theta) \varphi(\xi) d\xi \right) \rangle \\ & = \langle (f \otimes u^*)(0), \varphi(0) \rangle + \lim_{n \rightarrow \infty} \sum_{i=1}^{p_n} \langle u^*, L \left(\int_{\theta}^0 \beta_i^{(n)} \chi_{A_i^{(n)}}(\xi - \theta) \varphi(\xi) d\xi \right) \rangle \\ & = \langle u^*, f(0) \varphi(0) \rangle + \langle u^*, L \left(\int_{\theta}^0 f(\xi - \theta) \varphi(\xi) d\xi \right) \rangle . \end{aligned}$$

In particular, introducing the notation $\varepsilon_{\lambda}(\theta) := e^{\lambda\theta}$, we have

$$\ll \varepsilon_{\lambda} \otimes u^*, \varphi \gg = \langle u^*, \varphi(0) \rangle + \langle u^*, L \left(\int_{\theta}^0 e^{\lambda(\xi - \theta)} \varphi(\xi) d\xi \right) \rangle .$$

In terms of the operator S_{λ} defined in (2.8) the above formula reads as

$$\ll \varepsilon_{-\lambda} \otimes u^*, \varphi \gg = \langle u^*, S_{\lambda}(\varphi) \rangle . \tag{3.2}$$

3.1 The formal adjoint equation

Before proceeding to the construction of this equation let us remind some well known results about the integral representation of bounded linear operators defined on $C([-r, 0]; E)$. We refer to [14] for the general theory.

Any bounded linear operator $L : C([-r, 0]; E) \rightarrow E$ determines a unique vector measure $m : \hat{\Sigma} \rightarrow \mathcal{L}(E; E^{**})$ of bounded semivariation and such that for all $f \in C([-r, 0]; E)$ we have

$$L(f) = \int_{[-r, 0]} f dm$$

where $\mathcal{L}(E; E^{**})$ is the space of the bounded linear operators defined on E with values in E^{**} , E^{**} being the bidual of E , and $\hat{\Sigma}$ the Borel algebra on $[-r, 0]$.

For each $x^* \in E^*$, there exists a vector measure $m_{x^*} : \hat{\Sigma} \rightarrow E^*$ defined by

$$\langle m_{x^*}(A), x \rangle := \langle x^*, m(A)(x) \rangle \quad ; \quad A \in \hat{\Sigma} , x \in E$$

which satisfies

$$\int_{[-r, 0]} f dm_{x^*} = \langle x^*, L(f) \rangle \quad ; \quad \forall x^* \in E^* .$$

Next we define the linear operator $\tilde{L} : S([0, r]; E^*) \rightarrow E^*$ for any $f \in S([0, r]; E^*)$, $f = \sum_{i=1}^p x_i^* \chi_{A_i}$ by

$$\tilde{L}(f) := \sum_{i=1}^p m_{x_i^*}(-A_i).$$

Lemma 38 *If the vector measure m is of bounded variation, then \tilde{L} is continuous with respect to the sup norm in $S([0, r]; E^*)$.*

Proof.— Let $f = \sum_{i=1}^p x_i^* \chi_{A_i}$ be a simple function with $\|x_i^*\| \leq 1$, $i = 1, \dots, p$. Then

$$\begin{aligned} \|\tilde{L}(f)\| &= \left\| \sum_{i=1}^p m_{x_i^*}(-A_i) \right\| \leq \sum_{i=1}^p \|m_{x_i^*}(-A_i)\| \\ &\leq \sum_{i=1}^p \|m(-A_i)\| \leq v(m)([-r, 0]) < +\infty \end{aligned}$$

where $v(m)$ means the variation of m and we have used that

$$\begin{aligned} \|m_{x_i^*}(-A_i)\| &= \sup_{\|x\| \leq 1} | \langle m_{x_i^*}(-A_i), x \rangle | \\ &= \sup_{\|x\| \leq 1} | \langle x_i^*, m(-A_i)(x) \rangle | \leq \|m(-A_i)\|. \end{aligned}$$

Under this hypothesis, there exists a unique continuous extension $\tilde{\tilde{L}}$ of the operator \tilde{L} to the completion of $S([0, r]; E^*)$ equipped with the sup norm and we are able to define the *formal adjoint operator* of the operator L .

Definition 38 *The operator L^* is the restriction to the space \mathcal{C}^* of the extension operator $\tilde{\tilde{L}}$.*

Just as we did in the case of the formal duality, it is convenient to obtain the expression of L^* for the elements in $C([0, r]) \otimes E^*$. Calculations very similar to the ones above for Lemma 37 show that

Lemma 39 *For each $f \otimes u^* \in C([0, r]) \otimes E^*$, $L^*(f \otimes u^*) \in E^*$ is the linear form defined by*

$$\langle L^*(f \otimes u^*), u \rangle := \langle u^*, L(\hat{f} \otimes u) \rangle \quad ; \quad u \in E \quad (3.3)$$

where $\hat{f}(\theta) := f(-\theta)$.

For each $f \in C([-r, 0])$, $u \in E$, we have denoted by $f \otimes u$ the element of $C([-r, 0]; E)$ defined by

$$(f \otimes u)(\theta) := f(\theta)u \quad , \quad \theta \in [-r, 0].$$

In particular, for the functions $\varepsilon_\lambda^{(j)}$ defined by

$$\varepsilon_\lambda^{(j)}(\theta) := \frac{\theta^j}{j!} e^{\lambda\theta} \quad ; \quad \theta \in [-r, 0] \quad , \quad j = 1, 2, \dots \quad (3.4)$$

we reach the result

$$\begin{aligned} \langle L^*(\hat{\varepsilon}_\lambda^{(j)} \otimes u^*), u \rangle &= \langle u^*, L(\varepsilon_\lambda^{(j)} \otimes u) \rangle \\ &:= \langle u^*, L_\lambda^{(j)}(u) \rangle = \langle (L_\lambda^{(j)})^*(u^*), u \rangle \quad ; \quad u \in E \end{aligned}$$

and then

$$L^*(\hat{\varepsilon}_\lambda^{(j)} \otimes u^*) = (L_\lambda^{(j)})^*(u^*).$$

The existence of the operator L^* allows us to define a new linear functional differential equation associated with problem (CP).

Definition 39 *The formal adjoint equation associated to (CP) is*

$$\dot{\alpha}(s) = -L^*(\alpha_s) \quad ; \quad s \leq 0. \quad (3.5)$$

A function $\alpha \in C(]-\infty, r]; E^*)$ is a solution to the formal adjoint equation if $\alpha \in C^1(]-\infty, 0]; E^*)$ and satisfies (3.5) for all $s \leq 0$.

It is easy to check that $\alpha(s) := e^{-\lambda s} \otimes x^*$, $s \leq 0$ is a solution of (3.5) for all $x^* \in \mathcal{N}(L_\lambda^* - \lambda I)$. Suppose that $\alpha(t) := f(t)x^*$ is a solution of (3.5) on $]-\infty, b]$ and that $x(t)$ is a solution of (CP) on $[a, +\infty[$, $a < b$. Then $\langle\langle \alpha_t, x_t \rangle\rangle$ is constant for all $t \in [a, b]$.

Indeed

$$\begin{aligned} \langle\langle \alpha_t, x_t \rangle\rangle &= \langle \alpha_t(0), x_t(0) \rangle + \langle x^*, L \left(\int_\theta^0 f_t(\xi - \theta)x_t(\xi) d\xi \right) \rangle \\ &= \langle \alpha(t), x(t) \rangle + \langle x^*, L \left(\int_{t+\theta}^t f(\omega - \theta)x(\omega) d\omega \right) \rangle. \end{aligned}$$

Therefore

$$\begin{aligned} \frac{d}{dt} \langle\langle \alpha_t, x_t \rangle\rangle &= \langle \alpha'(t), x(t) \rangle + \langle \alpha(t), x'(t) \rangle \\ &\quad + \langle x^*, L(f(t - \theta)x(t)) \rangle - \langle x^*, L(f(t)x(t + \theta)) \rangle. \end{aligned}$$

But since

$$\langle \alpha(t), x'(t) \rangle - \langle x^*, L(f(t)x(t + \theta)) \rangle = \langle \alpha(t), x'(t) \rangle - \langle \alpha(t), L(x_t) \rangle = 0$$

we have

$$\begin{aligned} \frac{d}{dt} \langle\langle \alpha_t, x_t \rangle\rangle &= \langle \alpha'(t), x(t) \rangle + \langle x^*, L(f(t - \theta)x(t)) \rangle \\ &= \langle \alpha'(t), x(t) \rangle + \langle L^*(f_t \otimes x^*), x(t) \rangle \\ &= \langle \alpha'(t), x(t) \rangle + \langle L^*(\alpha_t), x(t) \rangle = 0. \end{aligned}$$

3.2 The operator A^* formal adjoint of A

In the sequel we assume that the vector measure m associated to L is of bounded variation and L^* has been defined.

Definition 40 We call the formal adjoint operator of A relative to the formal duality, the operator A^* defined by

$$A^*(\alpha) := -\dot{\alpha}$$

with domain

$$D(A^*) := \{ \alpha \in C^1([0, r]; E^*) ; \dot{\alpha}(0) = -L^*(\alpha) \}.$$

A^* is linear and closed, with a dense domain contained in \mathcal{C}^* .

From Lemma 37 and after an adequate integration by parts we obtain for $\alpha := f \otimes x^* \in D(A^*)$:

$$\langle\langle \alpha, A\varphi \rangle\rangle = \langle\langle A^*\alpha, \varphi \rangle\rangle \quad ; \quad \forall \varphi \in D(A).$$

Proposition 38 The spectra $\sigma(A)$ and $\sigma(A^*)$ of operators A and A^* satisfy the equality

$$\sigma(A) = \sigma(A^*).$$

Proof.— The solution of $(\lambda I - A^*)\varphi = \psi$ with $\psi \in \mathcal{C}^*$ is

$$\varphi(\theta) = e^{-\lambda\theta}\varphi(0) + \int_0^\theta e^{\lambda(s-\theta)}\psi(s) ds \quad ; \quad \theta \in [0, r]$$

where $\varphi(0)$ is to be determined so that $\varphi \in D(A^*)$. We get to

$$(\lambda I - L_\lambda^*)(\varphi(0)) = \psi(0) + L^* \left(\int_0^\theta e^{\lambda(s-\theta)}\psi(s) ds \right).$$

The right hand side of the above formula is similar to the operator S_λ defined in (2.8), but let us notice that it is not the adjoint of S_λ . We will denote it \widehat{S}_λ , that is,

$$\widehat{S}_\lambda(\psi) = \psi(0) + L^* \left(\int_0^\theta e^{\lambda(s-\theta)}\psi(s) ds \right).$$

Since \widehat{S}_λ is onto, we conclude that $\lambda \in \sigma(A^*)$ if and only if $\lambda \in \sigma(L_\lambda^*)$.

We have seen above that $\lambda \in \sigma(A)$ if and only if $\lambda \in \sigma(L_\lambda)$ and it is well known that $\sigma(L_\lambda) = \sigma(L_\lambda^*)$ ([39]). Therefore the result follows.

Notice that

$$\mathcal{N}(\lambda I - A) = \{\varepsilon_\lambda \otimes x ; x \in \mathcal{N}(\lambda I - L_\lambda)\}$$

$$\mathcal{N}(\mu I - A^*) = \{\varepsilon_{-\mu} \otimes x^* ; x^* \in \mathcal{N}(\mu I - L_\mu^*)\}.$$

Also, let us mention that if λ, μ are eigenvalues of A, A^* respectively, and $\lambda \neq \mu$, then $\langle\langle \alpha, \varphi \rangle\rangle = 0$ for all $\alpha \in \mathcal{N}(\mu I - A^*), \varphi \in \mathcal{N}(\lambda I - A)$. Indeed,

$$\langle\langle A^* \alpha, \varphi \rangle\rangle = \mu \langle\langle \alpha, \varphi \rangle\rangle = \langle\langle \alpha, A \varphi \rangle\rangle = \lambda \langle\langle \alpha, \varphi \rangle\rangle$$

therefore the condition $\lambda \neq \mu$ implies that $\langle\langle \alpha, \varphi \rangle\rangle = 0$.

Proposition 39 *The subspace $\mathcal{R}(\lambda I - A^*)$ is closed in \mathcal{C}^* if and only if $\mathcal{R}(\lambda I - A)$ is closed in \mathcal{C} .*

Proof.– Arguments similar to the ones used in the proofs of Lemmas 35 and 36 lead to

- a) For any $\lambda \in \mathbf{C}$ we have that $\alpha \in \mathcal{R}(\lambda I - A^*)$ if and only if $\widehat{S}_\lambda(\alpha) \in \mathcal{R}(\lambda I - L_\lambda^*)$.
- b) The subspace $\mathcal{R}(\lambda I - A^*)$ is closed in \mathcal{C}^* if and only if $\mathcal{R}(\lambda I - L_\lambda^*)$ is closed in E^* .

The proof is concluded by recalling the known result that $\mathcal{R}(\lambda I - L_\lambda)$ is a closed subspace in E if and only if $\mathcal{R}(\lambda I - L_\lambda^*)$ is closed in E^* .

3.3 Application to the model of cell population dynamics

We will now see how the theory developed in this section applies to equation (1.20). To this end, it is convenient to express the equation in a more general setting. First of all, there is a support property for solutions of (1.5), namely, both the functions \bar{n} and $\Delta n(t, \cdot)$ have their support contained in some compact interval $[A_1, A_2]$. Therefore, the integrals on the right-hand side of (1.20) are restricted to this interval.

With the notations

$$r := 2\Psi(0) + \tau \quad ; \quad E := L^1(A_1, A_2)$$

equation (1.20) is of the form

$$\begin{aligned} \frac{\partial \nu}{\partial t}(t, x) &= \int_{A_1}^{A_2} b(x) \nu(t - \tau, y) dy + \int_{A_1}^{A_2} c(x) \nu(t - \tau - \Psi(y), y) dy \\ &+ \int_{-r}^0 \int_{A_1}^{A_2} g(x, u, y) \nu(t + u, y) dy du, \end{aligned} \quad (3.6)$$

where b and c belong to $L^1(A_1, A_2)$, g is in $L^1((A_1, A_2) \times (-r, 0) \times (A_1, A_2))$.

The assumptions on f yield the following for g :

There exist $0 < r' < r$, $M \geq 0$, such that

$$\begin{aligned} g(x, y, u) &= 0, \quad 0 < u < r', \quad \text{for a.e. } (x, y) \in (A_1, A_2)^2, \\ \int_{A_1}^{A_2} \int_{-r}^0 |g(x, u, y)| dudx &\leq M, \quad \text{for a.e. } y \in (A_1, A_2). \end{aligned}$$

The map $L : C([-r, 0]; E) \rightarrow E$ associated with equation (3.5) is given by

$$\begin{aligned} (L\varphi)(x) &= b(x) \int_{A_1}^{A_2} \varphi(-\tau, y) dy + c(x) \int_{A_1}^{A_2} \varphi(-\tau - \Psi(y), y) dy \\ &+ \int_{-r}^0 \int_{A_1}^{A_2} g(x, u, y) \varphi(u, y) dy du. \end{aligned}$$

Here, $E^* = L^\infty(A_1, A_2)$. L^* is determined using formula (3.3). In fact, for $\varphi \in C([0, r])$, $v \in E$, $v^* \in E^*$, we have

$$\langle L^*(\varphi \otimes v^*), v \rangle = \langle v^*, L(\hat{\varphi} \otimes v) \rangle,$$

with

$$\begin{aligned} (L(\hat{\varphi} \otimes v))(x) &= b(x) \varphi(\tau) \int_{A_1}^{A_2} v(y) dy + c(x) \int_{A_1}^{A_2} \varphi(\tau + \Psi(y)) v(y) dy \\ &+ \int_{-r}^0 \int_{A_1}^{A_2} g(x, u, y) \varphi(-u) v(y) dy du, \end{aligned}$$

$$\begin{aligned} \langle v^*, L(\hat{\varphi} \otimes v) \rangle &= \int_{A_1}^{A_2} \left(\int_{A_1}^{A_2} b(x) v^*(x) dx \right) \varphi(\tau) v(y) dy \\ &+ \int_{A_1}^{A_2} \left(\int_{A_1}^{A_2} c(x) v^*(x) dx \right) \varphi(\tau + \Psi(y)) v(y) dy \\ &+ \int_{A_1}^{A_2} \left[\int_{A_1}^{A_2} \int_0^r g(x, -u, y) v^*(x) \varphi(u) dudx \right] v(y) dy. \end{aligned}$$

Identifying the right hand side with the product of $L^*(\varphi \otimes v^*)$ and v yields

$$L^*(\varphi \otimes v^*)(y) = \varphi(\tau) \int_{A_1}^{A_2} b(x)v^*(x) dx + \varphi(\tau + \Psi(y)) \int_{A_1}^{A_2} c(x)v^*(x) dx + \int_{A_1}^{A_2} \int_0^r g(x, -u, y)v^*(x)\varphi(u) dudx.$$

The above formula can be extended to the space $C([0, r]; E^*)$ as:

$$(L^*\varphi^*)(y) = \int_{A_1}^{A_2} b(x)\varphi^*(\tau, x) dx + \int_{A_1}^{A_2} c(x)\varphi^*(\tau + \Psi(y), x) dx + \int_{A_1}^{A_2} \int_0^r g(x, -u, y)\varphi^*(u, x) dudx.$$

We will now determine the formal dual product. Using formula (3.1), we have

$$\begin{aligned} \langle\langle \zeta \otimes v^*, \varphi \rangle\rangle &= \zeta(0) \int_{A_1}^{A_2} v^*(y)\varphi(0, y) dy + \int_{A_1}^{A_2} v^*(y)L \left(\int_{\theta}^0 \zeta(\xi - \theta)\varphi(\xi, \cdot) d\xi \right) (y) dy \\ &+ \int_{A_1}^{A_2} v^*(y)b(y) \left(\int_{A_1}^{A_2} \left(\int_{-\tau}^0 \zeta(\xi + \tau)\varphi(\xi, x) d\xi \right) dx \right) dy \\ &= \int_{A_1}^{A_2} (\zeta \otimes v^*)(0, y)\varphi(0, y) dy \\ &+ \int_{A_1}^{A_2} v^*(y)c(y) \left(\int_{A_1}^{A_2} \int_{-\Psi(u)-\tau}^0 \zeta(\xi + \tau + \Psi(u))\varphi(\xi, u) d\xi du \right) dy \\ &+ \int_{A_1}^{A_2} v^*(y) \left[\int_{-\tau}^0 \int_{A_1}^{A_2} g(y, u, z) \left(\int_u^0 \zeta(\xi - u)\varphi(\xi, z) d\xi \right) dz du \right] dy. \end{aligned}$$

Here, the formula extends to $C([0, r]; E^*) \times C([-r, 0], E)$. Substituting $\varphi^* \in C([0, r]; E^*)$ for $\zeta \otimes v^*$ in the above formula, we obtain

$$\begin{aligned} \langle\langle \varphi^*, \varphi \rangle\rangle &= \int_{A_1}^{A_2} \varphi^*(0, y)\varphi(0, y) dy \\ &+ \int_{A_1}^{A_2} c(y) \left[\int_{A_1}^{A_2} \int_{-\Psi(u)-\tau}^0 \varphi^*(\xi + \Psi(u) + \tau, y)\varphi(\xi, u) d\xi du \right] dy \\ &+ \int_{A_1}^{A_2} \int_{-\tau}^0 \int_{A_1}^{A_2} g(y, u, z) \left(\int_u^0 \varphi^*(\xi - u, y)\varphi(\xi, z) d\xi \right) dz dudy \\ &+ \int_{A_1}^{A_2} b(y) \left[\int_{A_1}^{A_2} \int_{-\tau}^0 \varphi^*(\xi + \tau, y)\varphi(\xi, x) d\xi dx \right] dy. \end{aligned}$$

3.4 Conclusion

The material presented in this section is mainly preparatory. We have now a formal dual product as well as a formal adjoint equation. In the next section, we will use these notions in the study of the spectral decomposition associated to abstract D.D.E. In as much as possible, we follow the method elaborated by J. Hale in [74], [75] and others for D.D.E. in finite dimensions. One of the problems when going from finite to infinite dimensions is that the representation of a linear functional in the infinite dimensional framework is not always possible, or at least not at all as easy to use as in finite dimensions. First of all, it is in general necessary to embed the equation in a much larger space with no nice way to identify the original problem in the larger one. As a result, it is in general impossible to describe the dual product to a large extent. For most computations, however, it is sufficient to use it for special functions in the formal dual space for which such a description is feasible. A second crucial difference which will appear when dealing with spectral decomposition is the lack of compactness in general D.D.E.

4. Linear Theory Of Abstract Functional Differential Equations Of Retarded Type

Let us recall that the subject of this section is the abstract D.D.E.:

$$x'(t) = L(x_t) \quad , \quad t > 0 \quad (4.1)$$

where $L : \mathcal{C} \longrightarrow E$ is a bounded linear operator and E is a Banach space.

We know that the Cauchy problem for (4.1) is well posed and the general solution gives rise to a strongly continuous semigroup of bounded linear operators. We have associated to the problem a dual product between \mathcal{C} and $\mathcal{C}^* := C([0, r], E^*)$ and an adjoint equation.

One way to look at the dual product is to consider that it provides a dynamic system of coordinates which allows, for example, to better investigate the asymptotic behavior of solutions and the stability of the system. This goes through a decomposition of the state space \mathcal{C} into the sum of a stable and an unstable part, or more generally, the sum of the most unstable and a more stable part.

Since we are in the infinite dimensional case, there is a basic feature of the semigroup in finite dimensions which will generally be lacking: the eventual compactness of the semigroup. Eventual compactness reduces the problem to the study of the eigenvalues and eigenvectors of the generator, and in many situations all amounts to looking at the real part of the roots of a characteristic equation. In the general situation, not much could be said. However, in the applications we have in view,

it happens often that the most unstable part of the spectrum leads to a decomposition of the state space and allows the same study as in the case of eventual compactness. This is when the most unstable part of the spectrum of the semigroup is *non essential*, a situation that has been encountered by several authors in the study of population dynamics models in the eighties ([42]).

The notion of essential/non essential spectrum however is a general one which was introduced in the sixties in connection with the study of partial differential equations. The next section presents a short survey of the subject. It is based on a review paper [1].

4.1 Some spectral properties of C_0 -semigroups

We start considering a linear closed operator A with dense domain $D(A) \subset E$, E being a Banach space. The spectrum of A , denoted $\sigma(A)$, is the set of $\lambda \in \mathbf{C}$, such that $\lambda I - A$ is not boundedly invertible. The complementary set in \mathbf{C} , $\rho(A) := \mathbf{C}/\sigma(A)$ is the resolvent set. We refer the reader to [15], [21], [77], [35], [37] for the general theory.

The spectrum of A can be subdivided into three disjoint subsets

$$\sigma(A) = \sigma_P(A) \cup \sigma_C(A) \cup \sigma_R(A)$$

where

- i) $\sigma_P(A)$ is the *point spectrum*, that is, the set of $\lambda \in \mathbf{C}$ such that $\lambda I - A$ is not injective;
- ii) $\sigma_C(A)$ is the *continuous spectrum*, that is, the set of $\lambda \in \mathbf{C}$ such that $\lambda I - A$ is injective and the range of $\lambda I - A$, denoted by $\mathcal{R}(\lambda I - A)$, is not E , but is dense in E ;
- iii) $\sigma_R(A)$ is the *residual spectrum*, that is, the set of $\lambda \in \mathbf{C}$ such that $\lambda I - A$ is injective and $\mathcal{R}(\lambda I - A)$ is not dense in E .

There are other ways to divide the spectrum. We will in fact consider another one, in addition to the one we have just given ([10]):

The *essential spectrum* of A , $\sigma_e(A)$, is the set of $\lambda \in \sigma(A)$ such that at least one of the following holds:

- i) $\mathcal{R}(\lambda I - A)$ is not closed.
- ii) The *generalized eigenspace associated to λ* , $\mathcal{N}(\lambda I - A) := \cup_{m=1}^{\infty} \text{Ker}(\lambda I - A)^m$ is infinite dimensional.
- iii) λ is a limit point of $\sigma(A)$.

The complementary set, $(\sigma \setminus \sigma_e)(A)$ is called the *non-essential spectrum*.

There are relationships between the two partitions of $\sigma(A)$. We refer to Theorem 3 in [1] for some results on this issue.

Let B be a bounded linear operator on some Banach space E , i.e. $E \in \mathcal{L}(E)$ and let $f : \Omega \subset \mathbf{C} \rightarrow \mathbf{C}$ be an holomorphic function with $\sigma(B) \subset \Omega$.

The *spectral theorem* states that $f(B)$ can be defined as a bounded linear operator on E and also:

$$\sigma(f(B)) = f(\sigma(B)).$$

This theorem extends partially to the case of an unbounded linear operator. If A is the infinitesimal generator of a strongly continuous linear semigroup $\{T(t)\}_{t \geq 0}$ (that can be, with some abuse, viewed as a generalized exponential operator $\exp(tA)$), then the point spectrum, the residual spectrum as well as the non essential spectrum of A and $T(t)$ correspond to each other in the simplest way possible, namely,

$$\sigma_J^*(T(t)) = \left\{ e^{t\lambda} ; \lambda \in \sigma_J(A) \right\}$$

where J can be either P (the point spectrum) or R (the residual spectrum) or NE (the non-essential spectrum), and the notation σ^* indicates that we are not counting 0 which might be a spectral value of $T(t)$ (and is indeed for $t > 0$ in the case of compact semigroups), while obviously it cannot arise from the spectrum of A .

But no such relationship can be asserted in general for the continuous spectrum or the essential spectrum. Examples of spectral values of the semigroup (other than 0) which do not arise from the spectrum of the generator can be found in the literature ([21]). In this direction the following partial result can be shown:

$$\exp(t\sigma_e(A)) \subset \sigma_e(T(t)) \quad , \quad t > 0.$$

This fact can be used if some information about the essential spectrum of the semigroup is available. For example, if we know that it is contained in the interior of the unit disk, for some $t > 0$. In this case, either the whole spectrum of $T(t)$ is located in the interior of the unit disk, which provides exponential stability of the semigroup, or there are spectral values of $T(t)$ which exceed in magnitude, the ones in the essential spectrum. These values are the ones which matter regarding the stability issue: they are non essential and thus emanate from the generator.

This result shows that it is important to have means to estimate the essential spectrum of an operator and possibly also of a semigroup of operators. We will now quote the few results known on this issue. The crucial point here is that the generator does not help at all at this point. Then we will proceed to the next step, that is to say, the spectral decomposition associated with the non essential spectrum. We will see that it works much the same as in finite dimensions.

We will end this section providing some estimates of the essential spectrum.

Let B be a linear bounded operator defined on the Banach space E . The *spectral radius* of B is the number

$$r(B) := \sup_{\lambda \in \sigma(B)} |\lambda|.$$

There is a formula for the computation of the spectral radius which does not use the spectrum:

$$r(B) = \lim_{n \rightarrow \infty} \|B^n\|^{1/n}.$$

Accordingly, the *essential spectral radius* of B is defined by:

$$r_e(B) := \sup_{\lambda \in \sigma_e(B)} |\lambda|.$$

The computation of the essential spectral radius is a little more involved, it has in fact to do with the distance of the operator to the set of compact operators. Notice that for compact operators, the essential spectrum reduces to $\{0\}$, thus the essential spectral radius is equal to 0. The following formula was proved by R. Nussbaum ([32]). It uses the notion of *measure of noncompactness* for sets and operators, which we recall in the following.

Let U be a bounded subset of E . The *measure of noncompactness* of U is the number $\alpha(U)$ defined by:

$$\alpha(U) := \inf \left\{ \varepsilon > 0 ; \begin{array}{l} U \text{ can be covered by a finite number of} \\ \text{subsets of } E \text{ of diameter less than } \varepsilon. \end{array} \right\}$$

In particular, the following is obvious: $\alpha(U) = 0$ if and only if U has a compact closure.

The above definition of measure of noncompactness can be extended to bounded operators $B \in \mathcal{L}(E)$:

$$\alpha(B) := \sup \left\{ \frac{\alpha(B(U))}{\alpha(U)} ; U \subset E \text{ bounded and } \alpha(U) \neq 0 \right\}.$$

We can now state the formula for the essential spectral radius ([32]):

$$r_e(B) = \lim_{n \rightarrow \infty} \alpha(B^n)^{1/n}.$$

Finally, the following quantity may also be of interest. The *spectral bound* of a linear closed operator A , denoted $s(A)$, is defined by:

$$s(A) := \sup \{ \operatorname{Re} \lambda ; \lambda \in \sigma(A) \}.$$

Corresponding to the spectral radius of an operator is the *growth bound* of a semigroup $\{T(t)\}_{t \geq 0}$. It is the quantity ω_0 defined by:

$$\omega_0 := \lim_{t \rightarrow +\infty} \log \|T(t)\|.$$

The connection between the growth bound and the spectral radius is what the intuition suggests it should be, that is:

$$\forall t > 0 \quad , \quad r(T(t)) = e^{\omega_0 t}.$$

Accordingly we can define the *essential growth bound* of the semigroup. It is the quantity ω_1 defined by:

$$\omega_1 := \lim_{t \rightarrow +\infty} \log \alpha [T(t)].$$

We also have the expected relationship

$$r_e(T(t)) = e^{\omega_1 t}.$$

The potential interest of the theory that will be presented next lies in the following formula ([42]):

$$\omega_0 = \max \left(\omega_1 \quad , \quad \sup_{\lambda \in (\sigma \setminus \sigma_e)(A)} \operatorname{Re} \lambda \right).$$

If we can compute or at least estimate ω_1 and show that $\omega_1 < \omega_0$ or $\omega_1 < s(A)$, then the growth bound will be determined by the non-essential spectrum of the generator.

4.2 Decomposition of the state space $C([-r, 0]; E)$

Let $\sigma(A)$, $\sigma_e(A)$ be the spectrum and the essential spectrum respectively of the infinitesimal generator A of the semigroup $\{T(t)\}_{t \geq 0}$ defined by the solutions to (4.1). From the general theory about operator reduction for isolated points of the spectrum ([77], [42]), we obtain the following theorem which yields the decomposition of \mathcal{C} into a direct sum:

Theorem 2 *Let $\lambda \in (\sigma \setminus \sigma_e)(A)$. Then λ is an eigenvalue of A and for some positive integer m we have*

$$C = \mathcal{N}(\lambda I - A)^m \oplus \mathcal{R}(\lambda I - A)^m$$

where $\mathcal{N}(\lambda I - A)^m$ is the generalized eigenspace of A with respect to λ and $\dim \mathcal{N}(\lambda I - A)^m = q < +\infty$.

Moreover A is completely reduced by this decomposition, A restricted to $\mathcal{N}(\lambda I - A)^m$ is bounded with spectrum $\{\lambda\}$ and the subspaces $\mathcal{N}(\lambda I - A)^m$, $\mathcal{R}(\lambda I - A)^m$ are invariant under the semigroup $\{T(t)\}_{t \geq 0}$.

The description of the fundamental solution matrix associated with a finite dimensional invariant subspace done in [74] for problem (4.1) in finite-dimensional spaces remains valid without essential modifications. Some of the properties owe to translation semigroup features enjoyed by abstract D.D.E. and are valid in a much more general context.

Let $\Phi_\lambda = (\varphi_1, \dots, \varphi_q)$ be a basis for $\mathcal{N}(\lambda I - A)^m$. There is a $q \times q$ constant matrix B_λ such that $\dot{\Phi}_\lambda = \Phi_\lambda B_\lambda$ and λ is the unique eigenvalue of B_λ . Therefore

$$\Phi_\lambda(\theta) = \Phi_\lambda(0)e^{B_\lambda \theta} \quad , \quad \theta \in [-r, 0]$$

and also

$$T(t)\Phi_\lambda = \Phi_\lambda e^{B_\lambda t} \quad , \quad t > 0.$$

Furthermore, if the initial value φ of (4.1) belongs to $\mathcal{N}(A - \lambda I)^m$, we have $\varphi = \Phi_\lambda a$ for some q -vector a and the solution is defined by

$$x_t = T(t)\varphi = T(t)\Phi_\lambda a = \Phi_\lambda e^{B_\lambda t} a \quad , \quad t > 0.$$

The same theory applies for a finite subset of $(\sigma \setminus \sigma_e)(A)$ and gives a very clear description of the geometric behaviour of the solutions of (4.1). We summarize these results in the following theorem.

Theorem 3 *Suppose $\Lambda = \{\lambda_1 \dots \lambda_s\}$ is any finite subset of the non-essential spectrum of A , $(\sigma \setminus \sigma_e)(A)$, and let $\Phi_\Lambda := (\Phi_{\lambda_1}, \dots, \Phi_{\lambda_s})$, $B_\Lambda := \text{diag}(B_{\lambda_1}, \dots, B_{\lambda_s})$, where Φ_{λ_j} is a basis of the generalized eigenspace associated to λ_j , $\mathcal{N}(\lambda_j I - A)^{m_j}$, with $\dim \mathcal{N}(\lambda_j I - A)^{m_j} = q_j < +\infty$, and B_{λ_j} is a constant matrix such that $A\Phi_{\lambda_j} = \Phi_{\lambda_j} B_{\lambda_j}$. The only eigenvalue of B_{λ_j} is λ_j , $j = 1, \dots, s$.*

Moreover, let

$$P_\Lambda := \mathcal{N}(\lambda_1 I - A)^{m_1} \oplus \dots \oplus \mathcal{N}(\lambda_s I - A)^{m_s}.$$

Then there exists a subspace Q_Λ of C invariant under A and $\{T(t)\}_{t \geq 0}$, such that

$$C = P_\Lambda \oplus Q_\Lambda$$

and the operator A is completely reduced by this decomposition. Furthermore, for any initial value $\varphi = \Phi_\Lambda a$ where a is a constant vector of dimension $q_1 + \dots + q_s$, the solution of the Cauchy problem associated to (4.1) is defined by

$$x_t = T(t)\varphi = T(t)\Phi_\Lambda a = \Phi_\Lambda e^{B_\Lambda t} a \quad , \quad t \geq 0.$$

We say that A is reduced by Λ .

4.3 A Fredholm alternative principle

What we want to do next is to use the *formal duality* presented in the previous section to obtain an explicit characterization for the projection operator on the subspace Q_Λ . The first result is a *Fredholm alternative principle* for the characterization of the range of $\lambda I - A$.

Proposition 40 *Let $\lambda \in (\sigma \setminus \sigma_e)(A)$. Then, $f \in \mathcal{R}(\lambda I - A)$ if and only if $\langle \langle \alpha, f \rangle \rangle = 0$ for all $\alpha = \varepsilon_{-\lambda} \otimes x^*$, with $x^* \in \mathcal{N}(\lambda I - (L_\lambda)^*)$ where $(L_\lambda)^*$ is the adjoint of operator L_λ .*

Proof.— Since $\lambda \in (\sigma \setminus \sigma_e)(A)$, we have that $\mathcal{R}(\lambda I - A)$ is closed, so Lemma 36 gives that $\mathcal{R}(\lambda I - L_\lambda)$ is closed in E . Therefore we can identify an element in the range of $\lambda I - L_\lambda$ in terms of the null space of the natural adjoint of this operator. Now, given f in \mathcal{C} , Lemma 35 tells us that $f \in \mathcal{R}(\lambda I - A)$ if and only if $S_\lambda(f) \in \mathcal{R}(\lambda I - L_\lambda)$, which holds if and only if $\langle x^*, S_\lambda(f) \rangle = 0$ for all $x^* \in \mathcal{N}(\lambda I - (L_\lambda)^*)$. But, according to formula (3.2), we have $\langle x^*, S_\lambda(f) \rangle = \langle \langle \varepsilon_{-\lambda} \otimes x^*, f \rangle \rangle$, which completes the proof of the proposition.

We can state Proposition 40 in a Fredholm alternative principle form:

Let $\lambda \in (\sigma \setminus \sigma_e)(A)$. Then, the equation $(\lambda I - A)\psi = \varphi$ has a solution if and only if $\langle \langle \varepsilon_\lambda \otimes x^, \varphi \rangle \rangle = 0$ for all $x^* \in \mathcal{N}(\lambda I - (L_\lambda)^*)$.*

4.4 Characterization of the subspace $\mathcal{R}(\lambda I - A)^m$ for λ in $(\sigma \setminus \sigma_e)(A)$

The fact that λ is non essential ensures that $\mathcal{R}(\lambda I - A)^m$ is closed with a finite codimension, and there is an integer m_0 such that $\mathcal{R}(\lambda I - A)^m$ is the same for all $m \geq m_0$. The computations we are going to present now are similar to the ones performed in finite dimensions. In fact, those computations are in some sense valid in general. But, in the case when λ is an essential spectral value, the computation will not be conclusive. The main point is that the equation which is originally set up in \mathcal{C} will

reduce to an equation in the product space E^m . In fact, the solution to $(\lambda I - A)^m \varphi = f$ is given by:

$$\varphi(\theta) = \sum_{j=0}^{m-1} \left(\frac{\theta^j}{j!} e^{\lambda\theta} \right) u_j + \int_{\theta}^0 e^{\lambda(\theta-\xi)} \frac{(\xi - \theta)^{m-1}}{(m-1)!} f(\xi) d\xi \quad , \quad \theta \in [-r, 0] \tag{4.2}$$

where u_0, \dots, u_{m-1} are arbitrary elements of E which must be determined so that $\varphi \in D((\lambda I - A)^m)$.

Introducing the notation

$$\varphi_{(k)}(\theta) := \left(\lambda I - \frac{d}{d\theta} \right)^k \varphi(\theta) \quad , \quad \theta \in [-r, 0]$$

we have that $\varphi \in D((\lambda I - A)^m)$ if and only if $\varphi_{(k)} \in D(A)$, $k = 0, \dots, m - 1$, which, in view of the expression (4.2) amounts to proving that each $\varphi_{(k)}$ satisfies the boundary condition $\dot{\varphi}_{(k)}(0) = L(\varphi_{(k)})$. By direct calculation, the problem reduces to an algebraic equation to be satisfied by the u_k ,

$$\mathcal{L}_{\lambda}^{(m)}(u_0, \dots, u_{m-1})^T = \mathcal{S}_{\lambda}^{(m)}(f)$$

where $(\dots)^T$ means the transpose vector and we have introduced the operators $\mathcal{L}_{\lambda}^{(m)} \in \mathcal{L}(E^m)$ defined by:

$$\mathcal{L}_{\lambda}^{(m)} := \begin{bmatrix} \lambda I - L_{\lambda} & I - L_{\lambda}^{(1)} & \dots & -L_{\lambda}^{(m-2)} & -L_{\lambda}^{(m-1)} \\ 0 & \lambda I - L_{\lambda} & \dots & -L_{\lambda}^{(m-3)} & -L_{\lambda}^{(m-2)} \\ \vdots & \vdots & & \vdots & \vdots \\ 0 & 0 & \dots & \lambda I - L_{\lambda} & I - L_{\lambda}^{(1)} \\ 0 & 0 & \dots & 0 & \lambda I - L_{\lambda} \end{bmatrix}$$

in which $L_{\lambda}^{(j)} \in \mathcal{L}(E)$, $L_{\lambda}^{(j)}(u) := L(\varepsilon_{\lambda}^{(j)} \otimes u)$, $u \in E$ and $\varepsilon_{\lambda}^{(j)}$ are defined in (3.4). The operators $\mathcal{S}_{\lambda}^{(m)} : \mathcal{C} \rightarrow E$ are defined by

$$\mathcal{S}_{\lambda}^{(m)}(f) := \begin{bmatrix} L \left(\int_{\theta}^0 e^{\lambda(\theta-\xi)} \frac{(\xi - \theta)^{m-1}}{(m-1)!} f(\xi) d\xi \right) \\ L \left(\int_{\theta}^0 e^{\lambda(\theta-\xi)} \frac{(\xi - \theta)^{m-2}}{(m-2)!} f(\xi) d\xi \right) \\ \vdots \\ L \left(\int_{\theta}^0 e^{\lambda(\theta-\xi)} (\xi - \theta) f(\xi) d\xi \right) \\ -\psi(0) + L \left(\int_{\theta}^0 e^{\lambda(\theta-\xi)} f(\xi) d\xi \right) \end{bmatrix} .$$

One can check readily that

$$L_\lambda^{(j)}(u) = \frac{1}{j!} \left(\frac{d}{d\lambda} \right)^j (L_\lambda)(u).$$

Therefore, we have proved the following result

Lemma 40 $f \in \mathcal{R}(\lambda I - A)^m$ if and only if $\mathcal{S}_\lambda^{(m)}(f) \in \mathcal{R}(\mathcal{L}_\lambda^{(m)})$.

We wish to locate $\mathcal{R}(\mathcal{L}_\lambda^{(m)})$ by means of the adjoint operator $(\mathcal{L}_\lambda^{(m)})^*$.

In order to achieve this, we need to see that $\mathcal{R}(\mathcal{L}_\lambda^{(m)})$ is a closed subspace of E^m . No other result similar to the one stated in Lemma 35 is known.

Since $\mathcal{R}(\lambda I - A)^m = (\mathcal{S}_\lambda^{(m)})^{-1}(\mathcal{R}(\mathcal{L}_\lambda^{(m)}))$, one obtains that if $\mathcal{R}(\mathcal{L}_\lambda^{(m)})$ is a closed subspace in E^m , then $\mathcal{R}(\lambda I - A)^m$ is closed in \mathcal{C} . However, the converse statement is of a bigger interest to us. We begin its analysis proving the following proposition.

Proposition 41 *Let $\lambda \in (\sigma \setminus \sigma_e)(A)$. Then $\mathcal{L}_\lambda^{(m)}$ is a Fredholm operator for each $m = 1, 2, \dots$*

The proof is an immediate consequence of the two next lemmas.

Lemma 41 *If $\lambda \in (\sigma \setminus \sigma_e)(A)$, then $\lambda I - L_\lambda$ is a Fredholm operator.*

Proof.— Since $\lambda \in (\sigma \setminus \sigma_e)(A)$, from Lemma 36 we infer that $\mathcal{R}(\lambda I - L_\lambda)$ is a closed subspace in E . On the other hand, using Lemma 34 and Lemma 35, we can see that $S_\lambda(\mathcal{R}(\lambda I - A)) = \mathcal{R}(\lambda I - L_\lambda)$ and $S_\lambda^{-1}(\mathcal{R}(\lambda I - L_\lambda)) = \mathcal{R}(\lambda I - A)$. Select a finite dimension vector space M complementing $\mathcal{R}(\lambda I - A)$ in \mathcal{C} , which can be done since, by assumption, $\mathcal{R}(\lambda I - A)$ has a finite codimension.

From what precedes we deduce that $S_\lambda(M) \cap \mathcal{R}(\lambda I - L_\lambda) = \{0\}$ and $S_\lambda(M) + \mathcal{R}(\lambda I - L_\lambda) = E$. So, we have proved that $\mathcal{R}(\lambda I - L_\lambda)$ is closed with a finite codimension.

Finally, $\mathcal{N}(\lambda I - A)$ is spanned by the functions $\varepsilon_\lambda \otimes u$ with $u \in \mathcal{N}(\lambda I - L_\lambda)$, then $\dim \mathcal{N}(\lambda I - L_\lambda) < +\infty$.

Therefore, $\lambda I - L_\lambda$ is a Fredholm operator.

Lemma 42 *Let $A_1 \dots A_m$ be Fredholm operators on E . The operator $A^{(m)}$ defined on the product space E^m by*

$$A^{(m)} := \begin{bmatrix} A_1 & & * \\ & \ddots & \\ 0 & & A_m \end{bmatrix}$$

where the operators $*$ are in $\mathcal{L}(E)$, is a Fredholm operator.

Proof.— Fredholm operators can be characterized as follows: let $F \in \mathcal{L}(E)$. Then, F is Fredholm if and only there exist two operators D and G in $\mathcal{L}(E)$ such that $F \circ D = I + \delta$ and $G \circ F = I + \gamma$, where δ and γ are finite rank operators.

Assuming that the $A_j, 1 \leq j \leq m$, are Fredholm operators, we can determine D_j, δ_j (resp. G_j, γ_j) in $\mathcal{L}(E)$ such that $A_j \circ D_j = I + \delta_j$ (resp. $G_j \circ A_j = I + \gamma_j$), with the δ_j and the γ_j having a finite rank. Define the following operator on E^m :

$$\mathcal{D} := \begin{bmatrix} D_1 & & * \\ & \ddots & \\ 0 & & D_m \end{bmatrix}$$

Accordingly, we may define \mathcal{G} . The product $\mathcal{A}^{(m)}\mathcal{D}$ can be decomposed as follows

$$\mathcal{A}^{(m)}\mathcal{D} = \begin{bmatrix} I & & * \\ & \ddots & \\ 0 & & I \end{bmatrix} + \begin{bmatrix} \delta_1 & & 0 \\ & \ddots & \\ 0 & & \delta_m \end{bmatrix} := \mathcal{U} + \Delta.$$

The first matrix \mathcal{U} in the right-hand side is invertible and the second one, Δ , is a finite rank operator. Multiplying the above expression on both sides by \mathcal{U}^{-1} leads to

$$\mathcal{A}^{(m)}\mathcal{D}\mathcal{U}^{-1} = I + \Delta\mathcal{U}^{-1}.$$

Obviously, $\Delta\mathcal{U}^{-1}$ has a finite rank. Proceeding exactly the same way on the left, we can also determine an operator $\tilde{\mathcal{G}}$ in $\mathcal{L}(E^m)$ such that

$$\tilde{\mathcal{G}}\mathcal{A}^{(m)} = I + \tilde{\Delta}$$

where $\tilde{\Delta}$ is a finite rank operator.

Therefore, $\mathcal{A}^{(m)}$ is a Fredholm operator.

We return to the problem set before the statement of Proposition 41 and we conclude that $\mathcal{R}(\mathcal{L}_\lambda^{(m)})$ is closed, so $\mathcal{S}_\lambda^{(m)}(f) \in \mathcal{R}(\mathcal{L}_\lambda^{(m)})$ if and only if $\langle X^*, \mathcal{S}_\lambda^{(m)}(f) \rangle = 0$ for all $X^* = (x_0^*, \dots, x_{m-1}^*)^T \in \mathcal{N}((\mathcal{L}_\lambda^{(m)})^*)$.

Notice that

$$\langle \varepsilon_\lambda^{(j)} \otimes u^*, \varphi \rangle = \langle u^*, \varepsilon_\lambda^{(j)}(0)\varphi(0) \rangle + \langle u^*, L \left(\int_\theta^0 \varepsilon_\lambda^{(j)}(\theta - \xi)\varphi(\xi) d\xi \right) \rangle$$

where the notation \hat{f} stands, as usual, for $f(-s)$. Therefore

$$\langle X^*, \mathcal{R}_\lambda^{(m)}(f) \rangle = \langle \langle \sum_{j=0}^{m-1} \hat{\varepsilon}_\lambda^{(j)} \otimes x_{m-j-1}^*, f \rangle \rangle = 0.$$

Let us consider the subspace

$$\mathcal{K}_\lambda^{(m)*} := \left\{ \alpha = \sum_{j=0}^{m-1} \hat{\varepsilon}_\lambda^{(j)} \otimes x_{m-j-1}^* ; (x_0^*, \dots, x_{m-1}^*)^T \in \mathcal{N} \left(\left(\mathcal{L}_\lambda^{(m)} \right)^* \right) \right\}.$$

Since $\mathcal{L}_\lambda^{(m)}$ is a Fredholm operator, the same is true for its adjoint, thus we have that $\dim \mathcal{N} \left(\left(\mathcal{L}_\lambda^{(m)} \right)^* \right) = p$ for some $p < +\infty$ and then, $\dim \mathcal{K}_\lambda^{(m)*} = p$.

We summarize the results achieved up to now in the following proposition.

Proposition 42 *Let $\lambda \in (\sigma \setminus \sigma_e)(A)$ and let m be a positive integer. Then $f \in \mathcal{R}(\lambda I - A)^m$ if and only if $\langle \alpha, f \rangle = 0$ for each $\alpha \in \mathcal{K}_\lambda^{(m)*}$. Moreover*

$$\mathcal{N}(\lambda I - A)^m = \left\{ \varphi = \sum_{j=0}^{m-1} \varepsilon_\lambda^{(j)} \otimes u_j \ ; (u_0, \dots, u_{m-1})^T \in \mathcal{N} \left(\mathcal{L}_\lambda^{(m)} \right) \right\}$$

and then $\dim \mathcal{N}(\lambda I - A)^m = \dim \mathcal{N} \left(\mathcal{L}_\lambda^{(m)} \right) < +\infty$.

Notice that $(x_0^*, \dots, x_{m-1}^*)^T \in \mathcal{N} \left(\left(\mathcal{L}_\lambda^{(m)} \right)^* \right)$ also implies that $(0, x_0^*, \dots, x_{m-2}^*)^T \in \mathcal{N} \left(\left(\mathcal{L}_\lambda^{(m)} \right)^* \right)$ and then it is easy to prove by direct calculation that the subspace $\mathcal{K}_\lambda^{(m)*}$ is differentiation invariant.

This fact implies that elements of this subspace are solutions of a linear O.D.E. In fact, choosing a basis $\Phi_\lambda^* := (\varphi_1^*, \dots, \varphi_p^*)^T$ of $\mathcal{K}_\lambda^{(m)*}$, we have

$$\dot{\Phi}_\lambda^* = (\dot{\varphi}_1^*, \dots, \dot{\varphi}_p^*)^T = B_\lambda^*(\varphi_1^*, \dots, \varphi_p^*)^T = B_\lambda^* \Phi_\lambda^*$$

where B_λ^* is a constant $p \times p$ matrix and λ is the only eigenvalue of this matrix. Therefore

$$\Phi_\lambda^*(\theta) = e^{B_\lambda^* \theta} \Phi_\lambda^*(0) \quad , \quad \theta \in [0, r].$$

4.5 Characterization of the projection operator onto the subspace Q_Λ

We recall the conclusion of Theorem 2, that is, for $\lambda \in (\sigma \setminus \sigma_e)(A)$, there exists a positive integer m for which a direct sum decomposition of the following type holds:

$$C = \mathcal{N}(\lambda I - A)^m \oplus \mathcal{R}(\lambda I - A)^m$$

with $\dim \mathcal{N}(\lambda I - A)^m = q < +\infty$ and $\varphi \in \mathcal{R}(\lambda I - A)^m$ if and only if $\langle\langle \alpha, \varphi \rangle\rangle = 0$ for all $\alpha \in \mathcal{K}_\lambda^{(m)*}$. Also $\dim \mathcal{K}_\lambda^{(m)*} = p < +\infty$.

We wish to find a suitable coordinate system which serves in characterizing the projection operator onto the subspace $\mathcal{R}(\lambda I - A)^m$. To this end, it is first convenient to investigate the relationship between the numbers p, q .

Recall that $p = \dim \mathcal{N} \left(\left(\mathcal{L}_\lambda^{(m)} \right)^* \right)$, $q = \dim \mathcal{N} \left(\mathcal{L}_\lambda^{(m)} \right)$ but in general, even for Fredholm operators, we have $p \neq q$. We now show that $q \leq p$ and next we will obtain some sufficient conditions for $p = q$.

Let $\Psi_\lambda = (\psi_1, \dots, \psi_q)$ be a basis for the subspace $\mathcal{N}(\lambda I - A)^m$ and $\Psi_\lambda^* = (\alpha_1^*, \dots, \alpha_p^*)^T$ a basis for $\mathcal{K}_\lambda^{(m)*}$, and make up the constant $p \times q$ matrix M :

$$M := \langle\langle \Psi_\lambda^*, \Psi_\lambda \rangle\rangle := [\langle\langle \alpha_i^*, \psi_j \rangle\rangle]_{i,j=1,\dots,p,q}. \tag{4.3}$$

If $(\lambda_1, \dots, \lambda_q)^T \in \mathcal{N}(M)$, then $\langle\langle \alpha^*, \lambda_1 \psi_1 + \dots + \lambda_q \psi_q \rangle\rangle = 0$ for all α^* in $\mathcal{K}_\lambda^{(m)*}$ and Proposition 42 implies that $\lambda_1 \psi_1 + \dots + \lambda_q \psi_q \in \mathcal{R}(\lambda I - A)^m$. But we also have $\lambda_1 \psi_1 + \dots + \lambda_q \psi_q \in \mathcal{N}(\lambda I - A)^m$ and then $\lambda_1 \psi_1 + \dots + \lambda_q \psi_q = 0$. Therefore $\lambda_i = 0, i = 1, \dots, q, \mathcal{N}(M) = \{0\}$. Thus we conclude that M has rank q , implying that $q \leq p$.

In particular we can choose two new bases $\Phi_\lambda := (\varphi_1, \dots, \varphi_q), \Phi_\lambda^* := (\varphi_1^*, \dots, \varphi_p^*)^T$ such that the constant $p \times q$ matrix satisfies

$$\langle\langle \Phi_\lambda^*, \Phi_\lambda \rangle\rangle = [\delta_{ij}]_{i,j=1,\dots,p,q}$$

where δ_{ij} is the Kronecker symbol.

We summarize all of this in a theorem:

Theorem 4 *If $\lambda \in (\sigma \setminus \sigma_e)(A)$, then $\dim \mathcal{N}(\lambda I - A)^m \leq \dim \mathcal{K}_\lambda^{(m)*}$ and there exist two bases $\Phi_\lambda = (\varphi_1, \dots, \varphi_q), \Phi_\lambda^* = (\varphi_1^*, \dots, \varphi_p^*)^T$ of the subspaces $\mathcal{N}(\lambda I - A)^m$ and $\mathcal{K}_\lambda^{(m)*}$ respectively such that*

$$\langle\langle \Phi_\lambda^*, \Phi_\lambda \rangle\rangle = [\langle\langle \varphi_i^*, \varphi_j \rangle\rangle]_{i,j=1,\dots,p,q} = [\delta_{ij}]_{i,j=1,\dots,p,q}.$$

Moreover, for each $\varphi \in C([-r, 0]; E)$ we have a unique decomposition $\varphi = \varphi_K + \varphi_I$ with $\varphi_K \in \mathcal{N}(\lambda I - A)^m$, $\varphi_I \in \mathcal{R}(\lambda I - A)^m$ and $\langle\langle \varphi_j^*, \varphi_I \rangle\rangle = 0$, $j = 1, \dots, p$.

Also $\varphi_K = \sum_{i=1}^q \lambda_i \varphi_i$ with $\langle\langle \varphi_i^*, \varphi_K \rangle\rangle = \lambda_i$ if $i \leq q$ and $\langle\langle \varphi_i^*, \varphi_K \rangle\rangle = 0$ if $i > q$.

Next we relate the matrices B_λ, B_λ^* defined by $\dot{\Phi}_\lambda = \Phi_\lambda B_\lambda, \dot{\Phi}_\lambda^* = B_\lambda^* \Phi_\lambda^*$.

It is easy to check that for $\alpha = f \otimes u^*$, $f \in C^1([0, r])$, $u^* \in E^*$ and for all $\varphi \in D(A)$, we have

$$\langle\langle \alpha, \dot{\varphi} \rangle\rangle + \langle\langle \dot{\alpha}, \varphi \rangle\rangle = \langle u^*, L(\hat{f} \otimes \varphi(0)) \rangle + \langle u^*, f(0)\varphi(0) \rangle$$

where $\hat{f}(\theta) = f(-\theta)$.

Thus, for $\alpha \in \mathcal{K}_\lambda^{(m)*}$ and $\varphi \in D(A)$,

$$\langle\langle \alpha, \dot{\varphi} \rangle\rangle + \langle\langle \dot{\alpha}, \varphi \rangle\rangle = 0.$$

Therefore

$$\begin{aligned} \langle\langle \dot{\Phi}_\lambda^*, \Phi_\lambda \rangle\rangle &= B_\lambda^* \langle\langle \Phi_\lambda^*, \Phi_\lambda \rangle\rangle = - \langle\langle \Phi_\lambda^*, \dot{\Phi}_\lambda \rangle\rangle \\ &= - \langle\langle \Phi_\lambda^*, \Phi_\lambda \rangle\rangle B_\lambda. \end{aligned}$$

Since

$$\langle\langle \Phi_\lambda^*, \Phi_\lambda \rangle\rangle = \begin{bmatrix} I_q \\ 0 \end{bmatrix}$$

where I_q is the identity $q \times q$ matrix, we obtain

$$B_\lambda^* = \begin{bmatrix} -B_\lambda & N \\ 0 & P \end{bmatrix}$$

where N and P are two matrices of the adequate dimensions and 0 is a zero submatrix.

Notice that for $p = q$ the last relation reduces to

$$B_\lambda^* = -B_\lambda.$$

Next we state some sufficient conditions to have $p = q$.

Lemma 43 *If the formal duality is non degenerate then $p = q$.*

Proof.— As usual, we say that the formal duality is non degenerate if the equality $\langle\langle \alpha, \varphi \rangle\rangle = 0$, for all $\varphi \in \mathcal{C}$, implies that $\alpha = 0$.

With the above notations, let $(\mu_1, \dots, \mu_p)^T \in \mathcal{N} (M^T)$ (M defined in (4.3)). Then, $\langle\langle \mu_1\alpha_1^* + \dots + \mu_p\alpha_p^*, \varphi \rangle\rangle = 0$ for all $\varphi \in \mathcal{R}(\lambda I - A)^m$ and also for all $\varphi \in \mathcal{C}$. Since the formal duality is non degenerate, we must have $\mu_1\alpha_1^* + \dots + \mu_p\alpha_p^* = 0$ and then $\mathcal{N} (M^T) = \{0\}$. This implies that $p \leq q$, so $p = q$.

The converse is not true in general. There are examples for finite dimensional spaces E such that $p = q$ and the formal duality is degenerate.

Finally we relate the equality $p = q$ with some compactness properties on the operator $\mathcal{L}_\lambda^{(m)}$. Introduce the operators

$$J^{(m)} := \begin{bmatrix} 0 & I & 0 & \dots & 0 & 0 \\ 0 & 0 & I & \dots & 0 & 0 \\ \vdots & \vdots & \vdots & & \vdots & \vdots \\ 0 & 0 & 0 & \dots & 0 & I \\ 0 & 0 & 0 & \dots & 0 & 0 \end{bmatrix}$$

$$H_\lambda^{(m)} := \begin{bmatrix} L_\lambda & L_\lambda^{(1)} & \dots & L_\lambda^{(m-2)} & L_\lambda^{(m-1)} \\ 0 & L_\lambda & \dots & L_\lambda^{(m-3)} & L_\lambda^{(m-2)} \\ \vdots & \vdots & & \vdots & \vdots \\ 0 & 0 & \dots & L_\lambda & L_\lambda^{(1)} \\ 0 & 0 & \dots & 0 & L_\lambda \end{bmatrix}.$$

If $\lambda \neq 0$, the operator $\lambda I + J^{(m)}$ is invertible and then

$$\mathcal{L}_\lambda^{(m)} = \lambda I + J^{(m)} - H_\lambda^{(m)} = (\lambda I + J^{(m)}) \left(I - (\lambda I + J^{(m)})^{-1} H_\lambda^{(m)} \right).$$

The operators $J^{(m)}$ and $H_\lambda^{(m)}$ commute and from well known general results about the spectrum of compact operators ([35], Th. 4.25) we have

Lemma 44 *Let $\lambda \in (\sigma \setminus \sigma_e)(A)$ be an eigenvalue of A , $\lambda \neq 0$. If the operator $H_\lambda^{(m)}$ or some of its iterates is compact, then $p = q$.*

Lemma 45 *Let λ, μ be given in $(\sigma \setminus \sigma_e)(A)$, $\lambda \neq \mu$. For any positive integers m, r and $\alpha \in \mathcal{K}_\lambda^{(m)*}$, $\varphi \in \mathcal{N}(\mu I - A)^r$, it holds that $\langle\langle \alpha, \varphi \rangle\rangle = 0$.*

Proof.– Given that the two polynomials in x , $(x - \lambda)^m$ and $(x - \mu)^r$ are relatively prime, the Bezout identity ensures the existence of two

polynomials $P(x), Q(x)$ such that

$$I = \left(\lambda I - \frac{d}{d\theta} \right)^m P \left(\frac{d}{d\theta} \right) + \left(\mu I - \frac{d}{d\theta} \right)^r Q \left(\frac{d}{d\theta} \right)$$

where $d/d\theta$ is the differentiation operator, so that

$$\begin{aligned} \langle\langle \alpha, \varphi \rangle\rangle &= \langle\langle \alpha, (\lambda I - d/d\theta)^m P(d/d\theta) \varphi \rangle\rangle + \langle\langle \alpha, (\mu I - d/d\theta)^r Q(d/d\theta) \varphi \rangle\rangle \\ &= \langle\langle (d/d\theta + \lambda I)^m \alpha, P(d/d\theta) \varphi \rangle\rangle + \langle\langle \alpha, Q(d/d\theta) (\mu I - d/d\theta)^r \varphi \rangle\rangle \\ &= 0. \end{aligned}$$

Let $\Lambda = \{\lambda_1, \dots, \lambda_s\}$ be a finite subset of non essential points of $\sigma(A)$ and consider the decomposition of the space $C([-r, 0]; E)$ stated in Theorem 3. We are now able to characterize the subspace Q_Λ by an orthogonality relation associated with the formal duality.

To this end, we define

$$P_\Lambda^* := \mathcal{K}_{\lambda_1}^{(m_1)*} \oplus \dots \oplus \mathcal{K}_{\lambda_s}^{(m_s)*}.$$

Next, let Φ_j, Φ_j^* be bases of the subspaces $\mathcal{N}(\lambda_j I - A)^{m_j}, \mathcal{K}_{\lambda_j}^{(m_j)*}$ respectively, $j = 1, \dots, s$. From the results stated above we know that each constant $p_j \times q_j$ matrix $J_j := \langle\langle \Phi_j^*, \Phi_j \rangle\rangle$, $q_j \leq p_j$, has rank equal to q_j and also the matrix $\langle\langle \Phi_k^*, \Phi_l \rangle\rangle$ is zero for $k \neq l$. Then the matrix J of order $(p_1 + \dots + p_s) \times (q_1 + \dots + q_s)$,

$$J := [\langle\langle \Phi_j^*, \Phi_k \rangle\rangle]_{j,k=1,\dots,s}$$

has rank equal to $q_1 + \dots + q_s$.

Therefore there exist two bases $\Phi_\Lambda, \Phi_\Lambda^*$ of the subspaces P_Λ, P_Λ^* respectively such that the constant matrix $\langle\langle \Phi_\Lambda^*, \Phi_\Lambda \rangle\rangle$ satisfies

$$\langle\langle \Phi_\Lambda^*, \Phi_\Lambda \rangle\rangle = [\delta_{ij}]_{i,j=1,\dots,p_1+\dots+p_s, q_1+\dots+q_s}.$$

Finally we have found a characterization of the projection onto the subspace Q_Λ . Keeping all the above notations, we have proved the following:

Theorem 5 *Consider the direct sum decomposition*

$$\mathcal{C} = P_\Lambda \oplus Q_\Lambda.$$

Then,

$$Q_\Lambda = \{\varphi \in \mathcal{C} ; \langle\langle \Phi_\Lambda^*, \varphi \rangle\rangle = 0\}.$$

Moreover, any $\varphi \in \mathcal{C}$ may be written as $\varphi = \varphi_{P_\Lambda} + \varphi_{Q_\Lambda}$ with $\langle\langle \Phi_\Lambda^*, \varphi_{Q_\Lambda} \rangle\rangle = 0$ and $\varphi_{P_\Lambda} = \Phi_\Lambda a$ where a is a constant vector of dimension $q_1 + \dots + q_s$ such that

$$\langle\langle \Phi_\Lambda^*, \varphi \rangle\rangle = \langle\langle \Phi_\Lambda^*, \varphi_{P_\Lambda} \rangle\rangle = \langle\langle \Phi_\Lambda^*, \Phi_\Lambda \rangle\rangle a = \begin{bmatrix} a \\ 0 \end{bmatrix}$$

and 0 is the zero vector of dimension $p_1 + \dots + p_s - (q_1 + \dots + q_s)$.

Notice that if $p_j = q_j, j = 1, \dots, s$, then

$$\varphi_{P_\Lambda} = \Phi_\Lambda a = \Phi_\Lambda \ll \Phi_\Lambda^*, \varphi \gg .$$

4.6 Conclusion

Several extensions of Hale’s theory of functional differential equations to infinite dimensions exist in the literature, starting from the one given by C.C. Travis and G.F. Webb [94]. The main motivation is the study of partial differential equations with finite or infinite delay. In most cases, the equation is of the form

$$x'(t) = Ax(t) + \int_{-r}^0 d\eta(s)x(t + s)$$

where A generates a C_0 -semigroup on a Banach space X and $d\eta$ is a suitable restricted Stieltjes measure with values in $\mathcal{L}(X)$ (see [78], [79], [38], to quote a few). Another important motivation is related to control theory. Increasingly elaborate extensions of earlier work by C. Bernier and A. Manitius, [9], [27], on attainability completeness or degeneracy, to the case of partial differential equations with delays have been given by S. Nakagiri [29], [30], [31]. The work done by S. Nakagiri includes results on the spectral theory of such equations and the characterization of some generalized eigenspaces in terms of the solutions of an adjoint equation. Many of the considerations of this author are similar to ours. The results differ in that some restrictions are imposed by Nakagiri on the measure, which takes the form

$$\int_{-r}^0 d\eta(s)\varphi(s) = \sum A_i\varphi(-\tau_i) + \int_{-r}^0 D(s)\varphi(s) ds$$

with $A_i \in \mathcal{L}(X), D \in L^1((-r, 0); \mathcal{L}(X))$. Moreover, it is assumed that the space X is reflexive. In contrast, we make no hypotheses on the functional term or on the space.

5. A Variation Of Constants Formula For An Abstract Functional Differential Equation Of Retarded Type

The aim of this section is to obtain a variation of constants formula for an abstract linear nonhomogeneous retarded functional differential equation. We will follow the work made in [7].

5.1 The nonhomogeneous problem

Let us consider the Cauchy problem for the nonhomogeneous retarded functional equation:

$$(NH) \quad \begin{cases} x'(t) = L(x_t) + f(t), & t \geq 0 \\ x_0 = \varphi \end{cases}$$

where $L : C([-r, 0]; E) \rightarrow E$, ($r > 0$), is a bounded linear operator, E is a Banach space, $f : [0, \tau^*[\rightarrow E$ ($\tau^* > 0$) is a continuous function and $\varphi \in \mathcal{C} := C([-r, 0]; E)$.

A solution of this problem is a function $x \in C([-r, \tau^*]; E)$, $x \in C^1([0, \tau^*]; E)$ which satisfies (NH) for $t \geq 0$.

Uniqueness of solution for (NH) follows immediately from that of the homogeneous problem. Regarding the existence we observe that if x^H is a solution of (CP) and x^P is a solution of the particular nonhomogeneous problem

$$\begin{cases} x'(t) = L(x_t) + f(t) ; & t \geq 0 \\ x_0 = 0 \end{cases} \quad (5.1)$$

then $x = x^H + x^P$ satisfies (NH). But we already know existence and uniqueness of x^H for each initial value $\varphi \in C([-r, 0]; E)$. Then it is enough to prove the existence of x^P .

Proposition 43 *Given $f \in C([0, +\infty[; E)$, there exists a unique function $x^P \in C([-r, +\infty[; E) \cap C^1([0, +\infty[; E)$ which satisfies (5.1) on $[0, +\infty[$.*

Proof.— For each fixed $T > 0$, let us consider the space

$$C_0([0, T]; E) := \{\varphi \in C([0, T]; E) ; \varphi(0) = 0\}$$

and the operator $\Pi : [0, T] \times C_0([0, T]; E) \rightarrow C([-r, 0]; E)$ defined by

$$\Pi(t, \varphi) := \begin{cases} 0, & \text{if } t + \theta < 0 \\ \varphi(t + \theta), & \text{if } t + \theta \geq 0. \end{cases}$$

If we extend φ by zero to the interval $[-r, T]$, it is easy to see that $\Pi(t, \varphi) = \varphi_t$ and then (5.1) is equivalent to the integral problem

$$x(t) = \int_0^t L(\Pi(s, x)) ds + \int_0^t f(s) ds \quad ; \quad t \geq 0$$

and also

$$x(t) = \mathcal{K}x(t) + \int_0^t f(s) ds \quad ; \quad t \in [0, T]$$

where \mathcal{K} is the bounded linear operator defined on $C_0([0, T]; E)$ by

$$\mathcal{K}u(t) = \int_0^t L(\Pi(s, u)) ds.$$

It is enough to prove that $I - \mathcal{K}$ is invertible. Since

$$\|\mathcal{K}u\|_{C([0, T]; E)} \leq T\|L\|\|u\|_{C([0, T]; E)}$$

we obtain the following estimations for the iterates of \mathcal{K} :

$$\|\mathcal{K}^n\| \leq \frac{\|L\|^n T^n}{n!} \quad ; \quad n = 1, 2, \dots$$

and the result follows easily.

5.2 Semigroup defined in $\mathcal{L}(E)$

For each $\Phi \in C([-r, 0]; \mathcal{L}(E))$, $b \in E$, let $\Phi \otimes b \in C([-r, 0]; E)$ be the function defined by

$$(\Phi \otimes b)(\theta) := \Phi(\theta)(b) \quad ; \quad \theta \in [-r, 0]$$

and then consider the bounded linear operator

$$\tilde{L} : C([-r, 0]; \mathcal{L}(E)) \longrightarrow \mathcal{L}(E) \quad \tilde{L}(\Phi)(b) := L(\Phi \otimes b).$$

Theorem 1 can be used to conclude that the Cauchy problem

$$\begin{cases} V'(t) = \tilde{L}(V_t) & ; \quad t \geq 0 \\ V_0 = \Phi \end{cases} \tag{5.2}$$

has a unique solution for each initial value $\Phi \in C([-r, 0]; \mathcal{L}(E))$. Also, this solution defines on $C([-r, 0]; \mathcal{L}(E))$ a strongly continuous translation semigroup $\{\tilde{T}(t)\}_{t \geq 0}$ such that $\tilde{T}(t)\Phi = V_t$, $t \geq 0$.

The infinitesimal generator of this semigroup is

$$\tilde{A}\Phi := \dot{\Phi} \quad ; \quad D(\tilde{A}) := \{\Phi \in C([-r, 0]; \mathcal{L}(E)) \ ; \ \dot{\Phi}(0) = \tilde{L}(\Phi)\}.$$

Proposition 44 *The semigroup $\{T(t)\}_{t \geq 0}$ associated to the solution of (CP) is related to the semigroup $\{\tilde{T}(t)\}_{t \geq 0}$ by*

$$\left(\tilde{T}(t)\Phi\right)(\theta)(b) = T(t)(\Phi \otimes b)(\theta) \quad ; \quad \forall b \in E \quad ; \quad \theta \in [-r, 0].$$

Proof.— Let $\{U(t)\}_{t \geq 0}$ be the family of bounded linear operators defined in E by:

$$U(t)(b) := T(t)(\Phi \otimes b)(0) \quad ; \quad t \geq 0.$$

Since $\{T(t)\}_{t \geq 0}$ is a translation semigroup, for $t > 0$, $\theta \in [-r, 0]$, $t + \theta \geq 0$, we have:

$$U_t(\theta)(b) = T(t + \theta) (\Phi \otimes b) (0) = T(t) (\Phi \otimes b) (\theta)$$

and $U = \Phi$ in $[-r, 0]$.

Also, for $t > 0$, $\theta \in [-r, 0]$, $t + \theta \leq 0$,

$$U_t(\theta)(b) = \Phi(t + \theta)(b) = (\Phi \otimes b)(t + \theta) = T(t) (\Phi \otimes b) (\theta).$$

Next, we look at the equation. We have

$$\tilde{L}(U_t)(b) = L(U_t \otimes b) = L(T(t) (\Phi \otimes b)) \quad ; \quad t \geq 0.$$

Now, let $\Phi \in D(\tilde{A})$ be the initial value in problem (5.2). It is easy to prove that $\Phi \otimes b \in D(A)$ for all $b \in E$, and then

$$U'(t)(b) = T(t)A(\Phi \otimes b)(0) = AT(t)(\Phi \otimes b)(0) = L(T(t)(\Phi \otimes b)) = \tilde{L}(U_t)(b).$$

That is, the function $U \in C([0, +\infty[; \mathcal{L}(E))$ satisfies (5.2). So, $U_t = \tilde{T}(t)\Phi$, by definition of the semigroup $\{\tilde{T}(t)\}_{t \geq 0}$ and uniqueness of the solution of equation (5.2). Finally, by density of $D(\tilde{A})$ in $C([-r, 0]; \mathcal{L}(E))$, equality extends to all Φ .

The proof of the proposition is complete.

5.3 The fundamental solution

Let $e \in E$ be given. We denote by $x^e(t)$ the unique solution of the problem

$$\begin{cases} x'(t) &= L(y_t) + e ; t \geq 0 \\ x_0 &= 0, \end{cases}$$

which, in integral form, reads as:

$$(x^e)(t) = \int_0^t L(x_s^e) ds + et \quad , \quad t \geq 0. \quad (5.3)$$

We now define the *fundamental solution* of (NH).

Definition 41 *The fundamental solution of problem (NH) is the family of operators $\{\mathcal{U}(t)\}_{t \geq 0}$, $\mathcal{U}(t) : E \rightarrow E$, defined by*

$$\mathcal{U}(t)e := (x^e)'(t) \quad ; \quad t \geq 0.$$

Observe that $\mathcal{U}(0) = I$ and $\mathcal{U}(t)e = L(x_t^e) + e$. Also, it is easy to prove that for each $e \in E$ fixed, the function $t \rightarrow \mathcal{U}(t)e$ is continuous in \mathbf{R}_+ .

Lemma 46 For all $t \geq 0$, we have $\mathcal{U}(t) \in \mathcal{L}(E)$.

Proof.— Given $e \in E$, from (5.3) we have:

$$\begin{aligned} \|x_t^e\|_C &\leq \sup_{\theta \in [-t, 0]} \left(\|L\| \int_0^{t+\theta} \|x_s^e\|_C ds + (t + \theta)\|e\| \right) \\ &= \|L\| \int_0^t \|x_s^e\|_C ds + t\|e\|. \end{aligned}$$

This implies that ([74]):

$$\|x_t^e\|_C \leq t\|e\| \exp \left(\int_0^t \|L\| ds \right) = t\|e\|e^{t\|L\|}.$$

Therefore

$$\|\mathcal{U}(t)e\| \leq \|L\| \|x_t^e\|_C + \|e\| \leq \|e\| \left(1 + t\|L\|e^{t\|L\|} \right).$$

We are now going to prove the continuity in \mathbf{R}_+ of the function $t \rightarrow \mathcal{U}(t)$ and to this end we need to introduce another family of operators which is related to the fundamental solution by integration.

More precisely, let $\{\mathcal{V}(t)\}_{t \geq 0}$ be the family of operators defined by:

$$\mathcal{V}(t) : E \longrightarrow E \quad ; \quad \mathcal{V}(t)e := x^e(t).$$

We have

$$\mathcal{V}(t)e = \int_0^t (x^e)'(s) ds = \int_0^t \mathcal{U}(s)e ds$$

and also

$$\|\mathcal{V}(t)e\| \leq \|e\| \int_0^t \|\mathcal{U}(s)\| ds \leq \|e\| \int_0^t \left(1 + s\|L\|e^{s\|L\|} \right) ds$$

which proves that $\mathcal{V}(t) \in \mathcal{L}(E)$, $t \geq 0$.

Proposition 45 The function $t \rightarrow \mathcal{V}(t)$ is continuously differentiable from \mathbf{R}_+ into $\mathcal{L}(E)$.

Proof.— Let $t_1, t_2 \in \mathbf{R}_+$:

$$\begin{aligned} \|\mathcal{V}(t_1) - \mathcal{V}(t_2)\| &= \sup_{\|e\| \leq 1} \|\mathcal{V}(t_1)e - \mathcal{V}(t_2)e\| = \sup_{\|e\| \leq 1} \left\| \int_{t_1}^{t_2} \mathcal{U}(s)e ds \right\| \\ &\leq \sup_{\|e\| \leq 1} \|e\| \int_{t_1}^{t_2} \|\mathcal{U}(s)\| ds \\ &\leq \int_{t_1}^{t_2} \left(1 + s\|L\|e^{s\|L\|} \right) ds \longrightarrow 0 \quad (|t_1 - t_2| \rightarrow 0). \end{aligned}$$

The above inequality yields local Lipschitz continuity.

We extend \mathcal{V} to the interval $[-r, 0]$ by 0. Since $\mathcal{V}(0) = 0$, local Lipschitz continuity is preserved. It also holds for the map $t \rightarrow \mathcal{V}_t$ from \mathbf{R}_+ into $C([-r, 0]; \mathcal{L}(E))$. Therefore, the same holds for the map $t \rightarrow \tilde{L}(\mathcal{V}_t)$.

Observe that

$$x_s^e(\theta) = x^e(s + \theta) = \mathcal{V}(s + \theta)(e) = \mathcal{V}_s(\theta)e = (\mathcal{V}_s \otimes e)(\theta)$$

hence

$$L(x_s^e) = L(\mathcal{V}_s \otimes e) = \tilde{L}(\mathcal{V}_s)(e).$$

Substituting the right-hand side of the above formula for $L(x_s^e)$ in (5.3), we arrive at

$$\mathcal{V}(t) = \int_0^t \tilde{L}(\mathcal{V}_s) ds + tI \quad ; \quad t \geq 0 \tag{5.4}$$

from which, in view of local Lipschitz continuity of $\tilde{L}(\mathcal{V}_t)$, we can conclude that $\mathcal{V}(t)$ is continuously differentiable for $t \geq 0$ and it holds:

$$\mathcal{V}'(t) = \tilde{L}(\mathcal{V}_t) + I \quad ; \quad t \geq 0. \tag{5.5}$$

An immediate consequence of Proposition 45 is the continuity of the fundamental solution:

Corollary 6 *The function $t \rightarrow \mathcal{U}(t)$ is continuous from \mathbf{R}_+ into $\mathcal{L}(E)$.*

The fundamental solution satisfies a retarded equation which is formally similar to (5.2). To see this, we extend by zero the fundamental solution to the interval $[-r, 0]$. Since $\mathcal{U}(0) = I$, the extension is not continuous but we can define the sections of $\mathcal{U}(t)$.

These sections are related to $\mathcal{V}(t)$ by:

$$\mathcal{V}_t(\theta) = \mathcal{V}(t + \theta) = \int_0^{t+\theta} \mathcal{U}(s) ds = \begin{cases} 0, & \text{if } t + \theta < 0 \\ \int_{-\theta}^t \mathcal{U}_\tau(\theta) d\tau, & \text{if } t + \theta \geq 0 \end{cases}$$

and therefore we can easily show:

$$\mathcal{V}_t(\theta) = \int_0^t \mathcal{U}_\tau(\theta) d\tau \quad ; \quad t \geq 0 \quad ; \quad \theta \in [-r, 0].$$

From (5.5) we conclude that the fundamental solution satisfies the Cauchy problem:

$$\begin{cases} \mathcal{U}(t) &= \tilde{L} \left(\int_0^t \mathcal{U}_\tau d\tau \right) + I \quad ; \quad t \geq 0 \\ \mathcal{U}_0 &= X_0 \end{cases}$$

where $X_0(\theta) := 0$ if $\theta \in [-r, 0]$; $X_0(0) := I$.

This retarded functional equation can be written *formally* in the integral form:

$$\begin{cases} \mathcal{U}(t) &= \int_0^t \tilde{L}(\mathcal{U}_\tau) d\tau + I \quad ; \quad t \geq 0 \\ \mathcal{U}(0) &= X_0 \end{cases}$$

and also *formally* in the differential form:

$$\begin{cases} \mathcal{U}'(t) &= \tilde{L}(\mathcal{U}_t) \quad ; \quad t > 0 \\ \mathcal{U}_0 &= X_0. \end{cases}$$

Using the semigroup $\{\tilde{T}(t)\}_{t \geq 0}$ with some abuse, we may write *formally*:

$$\mathcal{U}_t = \tilde{T}(t)X_0 \quad ; \quad t \geq 0.$$

5.4 The fundamental solution and the nonhomogeneous problem

We keep the above notations and we are going to express the solution of the particular nonhomogeneous problem (5.1) in terms of the fundamental solution.

Theorem 7 *Let x^P be the solution of (5.1). Then we have:*

$$x^P(t) = \int_0^t \mathcal{U}(t-s)(f(s)) ds \quad ; \quad t \geq 0.$$

Proof.— By arguments similar to those employed in Lemma 46, we can prove the continuous dependence of x^P upon the function f . Hence it is enough to choose $f \in C^1([0, T]; E)$, $T > 0$.

In this case we have

$$\frac{d}{ds} [\mathcal{V}(t-s)(f(s))] = \left(\frac{d}{ds} \mathcal{V}(t-s) \right) (f(s)) + \mathcal{V}(t-s)(f'(s)).$$

We define

$$\begin{aligned} y(t) &:= \int_0^t \mathcal{U}(t-s)(f(s)) ds = - \int_0^t \frac{d}{ds} \mathcal{V}(t-s)(f(s)) ds \\ &= \mathcal{V}(t)(f(0)) + \int_0^t \mathcal{V}(t-s)(f'(s)) ds \quad ; \quad t \geq 0 \end{aligned}$$

and $y(t) = 0$ in $[-r, 0]$.

Observe that y is continuous in $[-r, +\infty[$, since $y(0) = 0$, but we do not assure the differentiability of y in $t = 0$.

We now prove that y satisfies the same equation as x^P :

$$\begin{aligned} y'(t) &= \mathcal{V}'(t)(f(0)) + \int_0^t \mathcal{V}'(t-s)(f'(s)) ds \\ &= \tilde{L}(\mathcal{V}_t)(f(0)) + \int_0^t \tilde{L}(\mathcal{V}_{t-s})(f'(s)) ds + f(t) \\ &= L\left(\mathcal{V}_t \otimes f(0) + \int_0^t \mathcal{V}_{t-s} \otimes f'(s) ds\right) + f(t). \end{aligned}$$

On the other hand, from the definition of y for $t \geq 0$ and the fact that both y and \mathcal{V} are identically for $t < 0$, we can easily check that

$$\mathcal{V}_t \otimes f(0) + \int_0^t \mathcal{V}_{t-s} \otimes f'(s) ds = y_t.$$

Substituting y_t for the left-hand side of the above expression in the formula of $y'(t)$ we obtain:

$$y'(t) = L(y_t) + f(t)$$

together with $y(t) = 0$ for $t \leq 0$, so $y(t) = x^P(t)$, which completes the proof of the theorem.

Lemma 47 *The sections of the solution x^P are given in terms of the fundamental solution by*

$$(x^P)_t = \int_0^t \mathcal{U}_{t-s} \otimes f(s) ds \quad ; \quad t \geq 0.$$

Proof.— We do not carry out the details of the calculations which are based on

$$\int_{t+\theta}^t \mathcal{U}_{t-s}(\theta)(f(s)) ds = \int_{t+\theta}^t \mathcal{U}(t+\theta-s)(f(s)) ds = 0.$$

We recall that the solution of (NH) is $x = x^H + x^P$ and so we obtain for each initial value $\varphi \in C([-r, 0]; E)$ the following formula:

$$x(t) = T(t)\varphi(0) + \int_0^t \mathcal{U}(t-s)(f(s)) ds \quad ; \quad t \geq 0$$

and also

$$x_t = T(t)\varphi + \int_0^t \mathcal{U}_{t-s} \otimes f(s) ds \quad ; \quad t \geq 0.$$

Formally:

$$x_t = T(t)\varphi + \int_0^t \left(\tilde{T}(t-s)X_0 \right) \otimes f(s) ds.$$

Finally, we can also express the solution of the homogeneous equation, x^H , in terms of the fundamental solution $\mathcal{U}(t)$.

Given $\varphi \in C([-r, 0]; E)$, let us define $\tilde{\varphi} \in C([-r, +\infty[; E)$:

$$\tilde{\varphi}(t) := \begin{cases} \varphi(t) & \text{if } t \in [-r, 0] \\ \varphi(0) & \text{if } t > 0. \end{cases}$$

Changing the unknown function x into y , defined by

$$x(t) = y(t) + \tilde{\varphi}(t)$$

we have that y satisfies the nonhomogeneous problem:

$$\begin{cases} y'(t) = L(y_t) + L(\tilde{\varphi}_t), & t > 0 \\ y_0 = 0. \end{cases}$$

Theorem 7 applies and yields the following expression

$$y(t) = \int_0^t \mathcal{U}(t-s) (L(\tilde{\varphi}_s)) ds, \quad t > 0.$$

Coming back to the original unknown function x , we obtain:

$$x(t) = \varphi(0) + \int_0^t \mathcal{U}(t-s) (L\tilde{\varphi}_s) ds, \quad t > 0.$$

Rewriting $\tilde{\varphi}$ in the form

$$\tilde{\varphi}(t) = \bar{\varphi}(t) + \varphi(0), \quad -r \leq t \leq +\infty$$

and using this expression in the quantity under the integral, we arrive at

$$x(t) = \varphi(0) + \int_0^t \mathcal{U}(t-s) (L\varphi(0)) ds + \int_0^{\min(t,r)} \mathcal{U}(t-s) (L\bar{\varphi}_s) ds$$

where $\varphi(0)$ after L in the first integral is to be considered as a constant function.

Finally we can write

$$x(t) = \left[I + \int_0^t \mathcal{U}(s)\tilde{L}(\tilde{I}) ds \right] (\varphi(0)) + \int_0^{\min(t,r)} \mathcal{U}(t-s) (L\bar{\varphi}_s) ds$$

with $\tilde{I} : [-r, 0] \rightarrow \mathcal{L}(E)$ defined by $\tilde{I}(\theta) := I$.

Comparing this representation with the solution of the homogeneous Cauchy problem associated with a constant initial data, we conclude that the first term is the restriction of the semigroup $\{T(t)\}_{t \geq 0}$ to the constant functions.

5.5 Decomposition of the nonhomogeneous problem in $C([-r, 0]; E)$

We keep the notations of sections 3 and 4. In what follows we accept that the measure m associated with the operator L is of bounded variation and therefore the operator L^* , formally adjoint to L , is defined.

Lemma 48 *Let $x(t)$ be a solution to (NH) defined in $[a, +\infty[$ and let $y(t) = g(t)u^*$ be a solution of the formally adjoint equation*

$$\dot{y}(t) = -L^*(y_t) \quad ; \quad t \leq 0$$

defined in $] - \infty, b]$, with $a < b$. Then, for all $t \in [a, b]$ we have:

$$\langle\langle y_t, x_t \rangle\rangle = \langle\langle y_0, x_0 \rangle\rangle + \int_0^t \langle y(s), f(s) \rangle ds.$$

Proof.— This can be done by calculations quite similar to those employed for the homogeneous problem. Hence we don't carry out the details.

We have

$$\langle\langle y_t, x_t \rangle\rangle = \langle y(t), x(t) \rangle + \langle u^*, L \left(\int_*^0 g(t + \xi - *)x(t + \xi) d\xi \right) \rangle$$

and then

$$\begin{aligned} \frac{d}{dt} \langle\langle y_t, x_t \rangle\rangle &= \langle \dot{y}(t), x(t) \rangle + \langle y(t), \dot{x}(t) \rangle \\ &+ \langle u^*, L(\hat{g}_t \otimes x(t)) \rangle - \langle u^*, L(g(t)x_t) \rangle \\ &= \langle y(t), f(t) \rangle . \end{aligned}$$

Integrating, the lemma follows.

Proposition 46 *Let x_t be the section of the solution to (NH) corresponding to the initial value $\varphi \in C([-r, 0]; E)$. Then*

$$\langle\langle \Phi_\Lambda^*, x_t \rangle\rangle = e^{-B_\Lambda^* t} \langle\langle \Phi_\Lambda^*, \varphi \rangle\rangle + \int_0^t \langle e^{B_\Lambda^*(s-t)} \Phi_\Lambda^*(0), f(s) \rangle ds$$

where $B_\Lambda^* := \text{diag}(B_{\lambda_1}^*, \dots, B_{\lambda_s}^*)$.

Proof.— We apply Lemma 48 to $y_t = e^{B_\Lambda^* t} \Phi_\Lambda^*$ and then

$$\langle\langle e^{B_\Lambda^* t} \Phi_\Lambda^*, x_t \rangle\rangle = \langle\langle \Phi_\Lambda^*, x_0 \rangle\rangle + \int_0^t \langle e^{B_\Lambda^* s} \Phi_\Lambda^*(0), f(s) \rangle ds.$$

Also, if we define

$$Z(t) = \langle\langle \Phi_\Lambda^*, x_t \rangle\rangle$$

by differentiation we obtain

$$\dot{Z}(t) = -B_\Lambda^* Z(t) + \langle \Phi_\Lambda^*(0), f(t) \rangle.$$

Let us suppose that that $p_j = q_j, j = 1, \dots, s$ and hence $B_\Lambda^* = -B_\Lambda$. We apply the decomposition of the space $C([-r, 0]; E)$ stated in theorems of section 4 and for x_t , section of the solution of (NH), we have

$$x_t = x_t^P + x_t^Q \quad ; \quad x_t^P \in P_\Lambda \quad ; \quad x_t^Q \in Q_\Lambda$$

where $x_t^P = \Phi_\Lambda a$ and

$$\begin{aligned} a &= \langle\langle \Phi_\Lambda^*, x_t \rangle\rangle = e^{-B_\Lambda^* t} \langle\langle \Phi_\Lambda^*, \varphi \rangle\rangle + \int_0^t \langle e^{B_\Lambda^*(s-t)} \Phi_\Lambda^*(0), f(s) \rangle ds \\ &= e^{B_\Lambda t} \langle\langle \Phi_\Lambda^*, \varphi \rangle\rangle + \int_0^t \langle e^{B_\Lambda(t-s)} \Phi_\Lambda^*(0), f(s) \rangle ds. \end{aligned}$$

From this we can obtain the projection of the solution x_t on the subspace P_Λ in terms of the semigroup $\{T(t)\}_{t \geq 0}$:

$$\begin{aligned} x_t^P &= \Phi_\Lambda e^{B_\Lambda t} \langle\langle \Phi_\Lambda^*, \varphi \rangle\rangle + \int_0^t \Phi_\Lambda e^{B_\Lambda(t-s)} \langle \Phi_\Lambda^*(0), f(s) \rangle ds \\ &= T(t) \varphi^P + \int_0^t T(t-s) \Phi_\Lambda \langle \Phi_\Lambda^*(0), f(s) \rangle ds. \end{aligned}$$

Let $X_0^P \in C([-r, 0]; \mathcal{L}(E))$ be the operator defined by

$$X_0^P := \Phi_\Lambda \langle \Phi_\Lambda^*(0), \cdot \rangle$$

that is,

$$X_0^P(\theta)(b) := \Phi_\Lambda(\theta) \langle \Phi_\Lambda^*(0), b \rangle \quad ; \quad b \in E \quad ; \quad \theta \in [-r, 0].$$

Since

$$\begin{aligned} (\tilde{T}(t) X_0^P)(\theta)(b) &= T(t) (X_0^P \otimes b)(\theta) = T(t) (X_0^P(\theta)(b)) \\ &= T(t) (\Phi_\Lambda(\theta) \langle \Phi_\Lambda^*(0), b \rangle) \end{aligned}$$

we finally obtain the characterization of the projection x_t^P in terms of the semigroups $\{T(t)\}_{t \geq 0}$, $\{\tilde{T}(t)\}_{t \geq 0}$ and the operator X_0^P :

$$x_t^P = T(t)\varphi^P + \int_0^t \left(\tilde{T}(t-s)X_0^P \right) \otimes f(s) ds.$$

Notice that if the measure m is not of bounded variation, the formal adjoint operator L^* is not defined but the last decomposition formula remains still valid. In fact, Proposition 46 can be proved directly, so that the last decomposition formulas are also valid.

Chapter 9

THE BASIC THEORY OF ABSTRACT SEMILINEAR FUNCTIONAL DIFFERENTIAL EQUATIONS WITH NON-DENSE DOMAIN

K. Ezzinbi

University Cadi Ayyad , Marrakech, Morocco.

ezzinbi@ucam.ac.ma

M. Adimy

Département de Mathématiques Appliquées,

ERS 2055, Université de Pau,

Avenue de l'université, 64000 Pau, France

adimy@univ-pau.fr

1. Introduction

Let $(X, |\cdot|)$ be an infinite dimensional Banach space and $\mathcal{L}(X)$ be the space of bounded linear operators from X into X . Suppose that $r > 0$ is a given real number. $\mathcal{C}([-r, 0], X)$ denotes the space of continuous functions from $[-r, 0]$ to X with the uniform convergence topology and we will use simply \mathcal{C}_X for $\mathcal{C}([-r, 0], X)$. For $u \in \mathcal{C}([-r, b], X)$, $b > 0$ and $t \in [0, b]$, let u_t denote the element of \mathcal{C}_X defined by $u_t(\theta) = u(t + \theta)$, $-r \leq \theta \leq 0$.

By an abstract semilinear functional differential equation on the space X , we mean an evolution equation of the type

$$\begin{cases} \frac{du}{dt}(t) = A_0 u(t) + F(t, u_t), & t \geq 0, \\ u_0 = \varphi, \end{cases} \quad (1.1)$$

where $A_0 : D(A_0) \subseteq X \rightarrow X$ is a linear operator, F is a function from $[0, +\infty) \times \mathcal{C}_X$ into X and $\varphi \in \mathcal{C}_X$ are given. The initial value problem associated with (1.1) is the following : given $\varphi \in \mathcal{C}_X$, to find a

continuous function $u : [-r, h) \rightarrow X$, $h > 0$, differentiable on $[0, h)$ such that $u(t) \in D(A_0)$, for $t \in [0, h)$ and u satisfies the evolution equation of (1.1) for $t \in [0, h)$ and $u_0 = \varphi$.

It is well-known (see for example [94] and [96]) that the classical semigroup theory ensures the well posedness of Problem (1.1) when A_0 is the infinitesimal generator of a C_0 -semigroup of bounded linear operators $(T_0(t))_{t \geq 0}$ in X or, equivalently when

(i) $\overline{D(A_0)} = X$,

(ii) there exist $M_0, \omega_0 \in \mathbb{R}$ such that if $\lambda > \omega_0$ $(\lambda I - A_0)^{-1} \in \mathcal{L}(X)$ and

$$\|(\lambda - \omega_0)^n (\lambda I - A_0)^{-n}\| \leq M_0, \quad \forall n \in \mathbb{N}.$$

In this case one can prove existence and uniqueness of a solution of (1.1), for example by using the variation-of-constants formula ([94], [96])

$$u(t) = \begin{cases} T_0(t)\varphi(0) + \int_0^t T_0(t-s)F(s, u_s)ds, & \text{if } t \geq 0, \\ \varphi(t), & \text{if } t \in [-r, 0], \end{cases}$$

for every $\varphi \in \mathcal{C}_X$.

For related results, see for example Travis and Webb [94], Webb [95], Fitzgibbon [72], Kunish and Schappacher ([78], [79]), Memory ([82], [83]), Wu [96], and the references therein. In all of the quoted papers, A_0 is an operator verifying (i) and (ii). In the applications, it is sometimes convenient to take initial functions with more restrictions. There are many examples in concrete situations where evolution equations are not densely defined. Only hypothesis (ii) holds. One can refer for this to [64] for more details. Non-density occurs, in many situations, from restrictions made on the space where the equation is considered (for example, periodic continuous functions, Hölder continuous functions) or from boundary conditions (e.g., the space C^1 with null value on the boundary is non-dense in the space of continuous functions). Let us now briefly discuss the use of integrated semigroups. In the case where the mapping F in Equation (1.1) is equal to zero, the problem can still be handled by using the classical semigroups theory because A_0 generates a strongly continuous semigroup in the space $\overline{D(A_0)}$. But, if $F \neq 0$, it is necessary to impose additional restrictions. A case which is easily handled is when F takes their values in $\overline{D(A_0)}$. On the other hand, the integrated semigroups theory allows the range of the operators F to be any subset of X .

Example 3 Consider the model of population dynamics with delay described by

$$\begin{cases} \frac{\partial u}{\partial t}(t, a) + \frac{\partial u}{\partial a}(t, a) = f(t, a, u_t(\cdot, a)), & (t, a) \in [0, T], \times [0, l], \\ u(t, 0) = 0, & t \in [0, T], \\ u(\theta, a) = \varphi(\theta, a), & (\theta, a) \in [-r, 0] \times [0, l], \end{cases} \tag{1.2}$$

where φ is a given function on $C_X := C([-r, 0], X)$, with $X = C([0, l], \mathbb{R})$. By setting $V(t) = u(t, \cdot)$, we can reformulate the partial differential problem (1.2) as an abstract semilinear functional differential equation

$$\begin{cases} V'(t) = A_0V(t) + F(t, V_t), & t \in [0, T], \\ V_0 = \varphi \in C_X, \end{cases} \tag{1.3}$$

where

$$\begin{cases} D(A_0) = \{u \in C^1([0, l], \mathbb{R}); u(0) = 0\}, \\ A_0u = -u', \end{cases}$$

and $F : [0, T] \times C_X \rightarrow X$ is defined by $F(t, \varphi)(a) = f(t, a, \varphi(\cdot, a))$ for $t \in [0, T]$, $\varphi \in C_X$ and $a \in [0, l]$.

Example 4 Consider the reaction-diffusion equation with delay described by

$$\begin{cases} \frac{\partial u}{\partial t}(t, x) = \Delta u(t, x) + f(t, x, u_t(\cdot, x)), & t \in [0, T], x \in \Omega, \\ u(t, x) = 0, & t \in [0, T], x \in \partial\Omega, \\ u(\theta, x) = \varphi(\theta, x), & \theta \in [-r, 0], x \in \Omega, \end{cases} \tag{1.4}$$

where $\Omega \subset \mathbb{R}^n$ is a bounded open set with regular boundary $\partial\Omega$, Δ is the Laplace operator in the sense of distributions on Ω and φ is a given function on $C_X := C([-r, 0], X)$, with $X = C(\bar{\Omega}, \mathbb{R})$.

The problem (1.4) can be reformulated as the abstract semilinear functional differential equation (1.3), with

$$\begin{cases} D(A_0) = \{u \in C(\bar{\Omega}, \mathbb{R}); \Delta u \in C(\bar{\Omega}, \mathbb{R}) \text{ and } u = 0 \text{ on } \partial\Omega\}, \\ A_0u = \Delta u, \end{cases}$$

and $F : [0, T] \times C_X \rightarrow X$ is defined by $F(t, \varphi)(x) = f(t, x, \varphi(\cdot, x))$ for $t \in [0, T]$, $\varphi \in C_X$ and $x \in \Omega$.

In the two examples given here, the operator A_0 satisfies (ii) but the domain $D(A_0)$ is not dense in X and so, A_0 does not generate a C_0 -semigroup. Of course, there are many other examples encountered in the applications in which the operator A_0 satisfies only (ii) (see [64]).

We will study here the abstract semilinear functional differential equation (1.1) in the case when the operator A_0 satisfies only the Hille-Yosida condition (ii). After providing some background materials in Section 2, we proceed to establish the main results. A natural generalized notion of solutions is provided in Section 3 by integral solutions. We derive a variation-of-constants formula which allows us to transform the integral solutions of the general equation to solutions of an abstract Volterra integral equation. We prove the existence, uniqueness, regularity and continuous dependence on the initial condition. These results give natural generalizations of results in [94] and [96]. In Section 4, we consider the autonomous case. We prove that the solutions generate a nonlinear strongly continuous semigroup, which satisfies a compactness property. In the linear case, the solutions are shown to generate a locally Lipschitz continuous integrated semigroup. In Section 5, we use a principle of linearized stability for strongly continuous semigroups given by Desh and Schappacher [65] (see also [87], [88] and [90]) to study, in the nonlinear autonomous case, the stability of Equation (1.1). In Section 6, we show in the linear autonomous case, the existence of a direct sum decomposition of a state space into three subspaces : stable, unstable and center, which are semigroup invariants. As a consequence of the results established in Section 6, the existence of bounded, periodic and almost periodic solutions is established in the sections 7 and 8. In the end, we give some examples.

2. Basic results

In this section, we give a short review of the theory of integrated semigroups and differential operators with non-dense domain. We start with a few definitions.

Definition 42 [56] *Let X be a Banach space. A family $(S(t))_{t \geq 0} \subset \mathcal{L}(X)$ is called an integrated semigroup if the following conditions are satisfied :*

- (i) $S(0) = 0$;
- (ii) *for any $x \in X$, $S(t)x$ is a continuous function of $t \geq 0$ with values in X ;*

- (iii) *for any $t, s \geq 0$*
$$S(s)S(t) = \int_0^s (S(t + \tau) - S(\tau))d\tau.$$

Definition 43 [56] *An integrated semigroup $(S(t))_{t \geq 0}$ is called exponentially bounded, if there exist constants $M \geq 0$ and $\omega \in \mathbb{R}$ such that*

$$\|S(t)\| \leq Me^{\omega t} \quad \text{for } t \geq 0.$$

Moreover $(S(t))_{t \geq 0}$ is called non-degenerate if $S(t)x = 0$, for all $t \geq 0$, implies that $x = 0$.

If $(S(t))_{t \geq 0}$ is an integrated semigroup, exponentially bounded, then the Laplace transform $R(\lambda) := \lambda \int_0^{+\infty} e^{-\lambda t} S(t) dt$ exists for all λ with $\operatorname{Re}(\lambda) > \omega$. $R(\lambda)$ is injective if and only if $(S(t))_{t \geq 0}$ is non-degenerate. $R(\lambda)$ satisfies the following expression

$$R(\lambda) - R(\mu) = (\mu - \lambda)R(\lambda)R(\mu),$$

and in the case when $(S(t))_{t \geq 0}$ is non-degenerate, there exists a unique operator A satisfying $(\omega, +\infty) \subset \rho(A)$ (the resolvent set of A) such that

$$R(\lambda) = (\lambda I - A)^{-1}, \text{ for all } \operatorname{Re}(\lambda) > \omega.$$

This operator A is called the generator of $(S(t))_{t \geq 0}$.

We have the following definition.

Definition 44 [56] *An operator A is called a generator of an integrated semigroup, if there exists $\omega \in \mathbb{R}$ such that $(\omega, +\infty) \subset \rho(A)$, and there exists a strongly continuous exponentially bounded family $(S(t))_{t \geq 0}$ of linear bounded operators such that $S(0) = 0$ and $(\lambda I - A)^{-1} = \lambda \int_0^{+\infty} e^{-\lambda t} S(t) dt$, for all $\lambda > \omega$.*

remark 2 *If an operator A is the generator of an integrated semigroup $(S(t))_{t \geq 0}$, then $\forall \lambda \in \mathbb{R}$, $A - \lambda I$ is the generator of the integrated semigroup $(S_\lambda(t))_{t \geq 0}$ given by*

$$S_\lambda(t) = e^{-\lambda t} S(t) + \lambda \int_0^t e^{-\lambda s} S(s) ds.$$

Proposition 47 [56] *Let A be the generator of an integrated semigroup $(S(t))_{t \geq 0}$. Then for all $x \in X$ and $t \geq 0$,*

$$\int_0^t S(s)x ds \in D(A) \text{ and } S(t)x = A \left(\int_0^t S(s)x ds \right) + tx.$$

Moreover, for all $x \in D(A)$, $t \geq 0$

$$S(t)x \in D(A) \quad \text{and} \quad AS(t)x = S(t)Ax,$$

and

$$S(t)x = tx + \int_0^t S(s)Ax ds.$$

Corollary 1 [56] *Let A be the generator of an integrated semigroup $(S(t))_{t \geq 0}$. Then for all $x \in X$ and $t \geq 0$ one has $S(t)x \in \overline{D(A)}$. Moreover, for $x \in X$, $S(\cdot)x$ is right-sided differentiable in $t \geq 0$ if and only if $S(t)x \in D(A)$. In that case*

$$S'(t)x = AS(t)x + x.$$

An important special case is when the integrated semigroup is locally Lipschitz continuous (with respect to time).

Definition 45 [81] *An integrated semigroup $(S(t))_{t \geq 0}$ is called locally Lipschitz continuous, if for all $\tau > 0$ there exists a constant $k(\tau) > 0$ such that*

$$\|S(t) - S(s)\| \leq k(\tau) |t - s|, \text{ for all } t, s \in [0, \tau].$$

In this case, we know from [81], that $(S(t))_{t \geq 0}$ is exponentially bounded.

Definition 46 [81] *We say that a linear operator A satisfies the Hille-Yosida condition (HY) if there exist $M \geq 0$ and $\omega \in \mathbb{R}$ such that $(\omega, +\infty) \subset \rho(A)$ and*

$$\sup \{ (\lambda - \omega)^n \|(\lambda I - A)^{-n}\|, n \in \mathbb{N}, \lambda > \omega \} \leq M. \tag{HY}$$

The following theorem shows that the Hille-Yosida condition characterizes generators of locally Lipschitz continuous integrated semigroups.

Theorem 2 [81] *The following assertions are equivalent.*

- (i) *A is the generator of a locally Lipschitz continuous integrated semigroup,*
- (ii) *A satisfies the condition (HY).*

In the sequel, we give some results for the existence of solutions of the following Cauchy problem

$$\begin{cases} \frac{du}{dt}(t) = Au(t) + f(t), & t \geq 0, \\ u(0) = x \in X, \end{cases} \tag{2.1}$$

where A satisfies the condition (HY), without being densely defined.

By a solution of Problem (2.1) on $[0, T]$ where $T > 0$, we understand a function $u \in C^1([0, T], X)$ satisfying $u(t) \in D(A)$ ($t \in [0, T]$) such that the two relations in (2.1) hold.

The following result is due to Da Prato and Sinestrari.

Theorem 3 [64] Let $A : D(A) \subseteq X \rightarrow X$ be a linear operator, $f : [0, T] \rightarrow X$, $x \in D(A)$ such that

- (a) A satisfies the condition **(HY)**.
- (b) $f(t) = f(0) + \int_0^t g(s) ds$ for some Bochner-integrable function g .
- (c) $Ax + f(0) \in \overline{D(A)}$.

Then there exists a unique solution u of Problem (2.1) on the interval $[0, T]$, and for each $t \in [0, T]$

$$|u(t)| \leq Me^{\omega t} \left(|x| + \int_0^t e^{-\omega s} |f(s)| ds \right).$$

In the case where x is not sufficiently regular (that is, x is just in $\overline{D(A)}$) there may not exist a strong solution $u(t) \in X$ but, following the work of Da Prato and Sinestrari [64], Problem (2.1) may still have an integral solution.

Definition 47 [64] Given $f \in L^1_{loc}(0, +\infty; X)$ and $x \in X$, we say that $u : [0, +\infty) \rightarrow X$ is an integral solution of (2.1) if the following assertions are true

- (i) $u \in \mathcal{C}([0, +\infty); X)$,
- (ii) $\int_0^t u(s) ds \in D(A)$, for $t \geq 0$,
- (iii) $u(t) = x + A \int_0^t u(s) ds + \int_0^t f(s) ds$, for $t \geq 0$.

From this definition, we deduce that for an integral solution u , we have $u(t) \in \overline{D(A)}$, for all $t > 0$, because $u(t) = \lim_{h \rightarrow 0} \frac{1}{h} \int_t^{t+h} u(s) ds$ and $\int_t^{t+h} u(s) ds \in D(A)$. In particular, $x \in \overline{D(A)}$ is a necessary condition for the existence of an integral solution of (2.1).

Theorem 4 [61] Suppose that A satisfies the condition **(HY)**, $x \in \overline{D(A)}$ and $f : [0, +\infty) \rightarrow X$ is a continuous function. Then the problem (2.1) has a unique integral solution which is given by

$$u(t) = S'(t)x + \frac{d}{dt} \int_0^t S(t-s)f(s) ds, \text{ pour } t \geq 0,$$

where $S(t)$ is the integrated semigroup generated by A . Furthermore, the function u satisfies the inequality

$$|u(t)| \leq Me^{\omega t} \left(|x| + \int_0^t e^{-\omega s} |f(s)| ds \right), \text{ for } t \geq 0.$$

Note that Theorem 4 also says that $\int_0^t S(t-s)f(s)ds$ is differentiable with respect to t .

3. Existence, uniqueness and regularity of solutions

We restate the problem

$$\begin{cases} \frac{du}{dt}(t) = A_0u(t) + F(t, u_t), & t \geq 0, \\ u_0 = \varphi \in \mathcal{C}_X, \end{cases} \tag{1.1}$$

where $F : [0, T] \times \mathcal{C}_X \rightarrow X$ is a continuous function.

Throughout this work, we assume that A_0 satisfies the Hille-Yosida condition on X :

(HY) there exist $M_0 \geq 0$ and $\omega_0 \in \mathbb{R}$ such that $(\omega_0, +\infty) \subset \rho(A_0)$ and

$$\sup \{ (\lambda - \omega_0)^n \|(\lambda I - A_0)^{-n}\|, n \in \mathbb{N}, \lambda > \omega_0 \} \leq M_0.$$

We know from Theorem 2 that A_0 is the generator of a locally Lipschitz continuous integrated semigroup $(S_0(t))_{t \geq 0}$ on X , (and $(S_0(t))_{t \geq 0}$ is exponentially bounded).

In view of the remark following Definition 44, we will sometimes assume without loss of generality that $\omega_0 = 0$.

Consider first the linear Cauchy problem

$$\begin{cases} u'(t) = A_0u(t), & t \geq 0, \\ u_0 = \varphi \in \mathcal{C}_X. \end{cases}$$

This problem can be reformulated as a special case of an abstract semi-linear functional differential equation with delay. This is

$$\begin{cases} u'(t) = (Au_t)(0), & t \geq 0, \\ u_0 = \varphi, \end{cases}$$

where

$$\begin{cases} D(A) = \{ \varphi \in \mathcal{C}^1([-r, 0], X); \varphi(0) \in D(A_0), \varphi'(0) = A_0\varphi(0) \}, \\ A\varphi = \varphi'. \end{cases}$$

We can show, by using the next result and Theorem 2, that the operator A satisfies the condition **(HY)**.

Proposition 48 *The operator A is the generator of a locally Lipschitz continuous integrated semigroup on \mathcal{C}_X given by*

$$(S(t)\varphi)(\theta) = \begin{cases} \int_\theta^0 \varphi(s) ds + S_0(t+\theta)\varphi(0), & t+\theta \geq 0, \\ \int_\theta^{t+\theta} \varphi(s) ds, & t+\theta < 0. \end{cases}$$

for $t \geq 0, \theta \in [-r, 0]$ and $\varphi \in C_X$.

Proof. It is easy to see that $(S(t))_{t \geq 0}$ is an integrated semigroup on C_X .

Consider $\tau > 0, t, s \in [0, \tau]$ and $\varphi \in C_X$.

If $t + \theta \geq 0$ and $s + \theta \geq 0$, we have

$$(S(t)\varphi)(\theta) - (S(s)\varphi)(\theta) = S_0(t + \theta)\varphi(0) - S_0(s + \theta)\varphi(0).$$

It follows immediately that there exists a constant $k := k(\tau) > 0$ such that

$$|(S(t)\varphi)(\theta) - (S(s)\varphi)(\theta)| \leq k|t - s| |\varphi(0)|,$$

because $(S_0(t))_{t \geq 0}$ is Lipschitz continuous on $[0, \tau]$.

If $t + \theta \leq 0$ and $s + \theta \leq 0$, we have

$$|(S(t)\varphi)(\theta) - (S(s)\varphi)(\theta)| = 0.$$

If $t + \theta \geq 0$ and $s + \theta \leq 0$, we obtain

$$(S(t)\varphi)(\theta) - (S(s)\varphi)(\theta) = S_0(t + \theta)\varphi(0) + \int_{s+\theta}^0 \varphi(u)du,$$

then

$$|(S(t)\varphi)(\theta) - (S(s)\varphi)(\theta)| \leq k(t + \theta) |\varphi(0)| - (s + \theta) \|\varphi\|,$$

This implies that

$$\|S(t) - S(s)\| \leq (k + 1) |t - s|.$$

It may be concluded that $(S(t))_{t \geq 0}$ is locally Lipschitz continuous.

In order to prove that A is the generator of $(S(t))_{t \geq 0}$, we calculate the spectrum and the resolvent operator of A .

Consider the equation

$$(\lambda I - A)\varphi = \psi,$$

where ψ is given in C_X , and we are looking for $\varphi \in D(A)$. The above equation reads

$$\lambda\varphi(\theta) - \varphi'(\theta) = \psi(\theta), \quad \theta \in [-r, 0].$$

Whose solutions are such that

$$\varphi(\theta) = e^{\lambda\theta}\varphi(0) + \int_{\theta}^0 e^{\lambda(\theta-s)}\psi(s) ds, \quad \theta \in [-r, 0].$$

φ is in $D(A)$ if $\varphi(0) \in D(A_0)$ and $\varphi'(0) = A_0\varphi(0)$, that is

$$\varphi(0) \in D(A_0) \quad \text{and} \quad (\lambda I - A_0)\varphi(0) = \psi(0).$$

By assumption on A_0 , we know that $(0, +\infty) \subset \rho(A_0)$. So, for $\lambda > 0$, the above equation has a solution $\varphi(0) = (\lambda I - A_0)^{-1}\psi(0)$.

Therefore, $(0, +\infty) \subset \rho(A)$ and

$$\left((\lambda I - A)^{-1}\psi \right) (\theta) = e^{\lambda\theta} (\lambda I - A_0)^{-1}\psi(0) + \int_{\theta}^0 e^{\lambda(\theta-s)}\psi(s)ds,$$

for $\theta \in [-r, 0]$ and $\lambda > 0$.

On the other hand, from the formula stated in Proposition 48, it is clear that $t \rightarrow (S(t)\varphi)(\theta)$ has at most exponential growth, not larger than $\omega_0 = 0$. Therefore, one can defined its Laplace transform, for each $\lambda > 0$. We obtain

$$\int_0^{+\infty} e^{-\lambda t} (S(t)\varphi)(\theta) dt = \int_0^{-\theta} e^{-\lambda t} \int_{\theta}^{t+\theta} \varphi(s)ds dt + \int_{-\theta}^{+\infty} e^{-\lambda t} \int_{\theta}^0 \varphi(s)ds dt + \int_{-\theta}^{+\infty} e^{-\lambda t} S_0(t+\theta)\varphi(0) dt.$$

Integrating by parts the first expression, it yields

$$\begin{aligned} \int_0^{+\infty} e^{-\lambda t} (S(t)\varphi)(\theta) dt &= -\frac{e^{\lambda\theta}}{\lambda} \int_{\theta}^0 \varphi(s)ds + \frac{1}{\lambda} \int_{\theta}^0 e^{\lambda(\theta-s)}\varphi(s)ds \\ &\quad + \frac{e^{\lambda\theta}}{\lambda} \int_{\theta}^0 \varphi(s)ds + \int_0^{+\infty} e^{\lambda(\theta-s)}S_0(s)\varphi(0)ds, \\ &= \frac{e^{\lambda\theta}}{\lambda} \left(\int_{\theta}^0 e^{-\lambda s}\varphi(s)ds + \int_0^{+\infty} e^{-\lambda s}S_0(s)\varphi(0)ds \right), \\ &= \frac{e^{\lambda\theta}}{\lambda} \left(\int_{\theta}^0 e^{-\lambda s}\varphi(s)ds + (\lambda I - A_0)^{-1}\varphi(0) \right), \\ &= \frac{1}{\lambda} \left((\lambda I - A)^{-1}\varphi \right) (\theta). \end{aligned}$$

So, A is related to $(S(t))_{t \geq 0}$ by the formula which characterizes the infinitesimal generator of an integrated semigroup. The proof of Proposition 48 is complete ■

Our next objective is to construct an integrated version of Problem (1.1) using integrated semigroups. We need to extend the integrated semigroup $(S(t))_{t \geq 0}$ to the space $\tilde{\mathcal{C}}_X = \mathcal{C}_X \oplus \langle X_0 \rangle$, where $\langle X_0 \rangle = \{X_0c, c \in X \text{ and } (X_0c)(\theta) = X_0(\theta)c\}$ and X_0 denotes the function defined by $X_0(\theta) = 0$ if $\theta < 0$ and $X_0(0) = Id_X$. We shall prove that this extension determines a locally Lipschitz continuous integrated semigroup on $\tilde{\mathcal{C}}_X$.

Proposition 49 *The family of operators $(\tilde{S}(t))_{t \geq 0}$ defined on $\tilde{\mathcal{C}}_X$ by*

$$\tilde{S}(t)\varphi = S(t)\varphi, \text{ for } \varphi \in \mathcal{C}_X$$

and

$$(\tilde{S}(t)X_0c)(\theta) = \begin{cases} S_0(t + \theta)c, & \text{if } t + \theta \geq 0, \\ 0, & \text{if } t + \theta \leq 0, \end{cases} \text{ for } c \in X,$$

is a locally Lipschitz continuous integrated semigroup on $\tilde{\mathcal{C}}_X$ generated by the operator \tilde{A} defined by

$$\begin{cases} D(\tilde{A}) = \{\varphi \in \mathcal{C}^1([-r, 0], X); \varphi(0) \in D(A_0)\}, \\ \tilde{A}\varphi = \varphi' + X_0(A_0\varphi(0) - \varphi'(0)). \end{cases}$$

Proof. Using the same reasoning as in the proof of Proposition 48, one can show that $(\tilde{S}(t))_{t \geq 0}$ is a locally Lipschitz continuous integrated semigroup on $\tilde{\mathcal{C}}_X$.

The proof will be completed by showing that

$$\begin{cases} (0, +\infty) \subset \rho(\tilde{A}) \text{ and} \\ (\lambda I - \tilde{A})^{-1} \tilde{\varphi} = \lambda \int_0^{+\infty} e^{-\lambda t} \tilde{S}(t) \tilde{\varphi} dt, \text{ for } \lambda > 0 \text{ and } \tilde{\varphi} \in \tilde{\mathcal{C}}_X. \end{cases}$$

For this, we need the following lemma.

Lemma 1 *For $\lambda > 0$, one has*

- (i) $D(\tilde{A}) = D(A) \oplus \langle e^{\lambda \cdot} \rangle$, where $\langle e^{\lambda \cdot} \rangle = \{e^{\lambda \cdot} c; c \in D(A_0), (e^{\lambda \cdot} c)(\theta) = e^{\lambda \theta} c\}$,
- (ii) $(0, +\infty) \subset \rho(\tilde{A})$ and

$$(\lambda I - \tilde{A})^{-1}(\varphi + X_0c) = (\lambda I - A)^{-1}\varphi + e^{\lambda \cdot}(\lambda I - A_0)^{-1}c,$$

for every $(\varphi, c) \in \mathcal{C}_X \times X$.

Proof of the lemma. For the proof of (i), we consider the following operator

$$\begin{aligned} l : D(\tilde{A}) &\rightarrow X \\ \varphi &\rightarrow l(\varphi) = A_0\varphi(0) - \varphi'(0). \end{aligned}$$

Let $\tilde{\Psi} \in D(\tilde{A})$ and $\lambda > 0$. Setting $\Psi = \tilde{\Psi} - e^{\lambda \cdot}(\lambda I - A_0)^{-1}l(\tilde{\Psi})$, we deduce that $\Psi \in \text{Ker}(l) = D(A)$, and the decomposition is clearly unique.

(ii) Consider the equation

$$(\lambda I - \tilde{A}) (\varphi + e^{\lambda \cdot} c) = \psi + X_0a,$$

where (ψ, a) is given, $\psi \in \mathcal{C}_X$, $a \in X$, and we are looking for (φ, c) , $\varphi \in D(A)$, $c \in D(A_0)$.

This yields

$$(\lambda I - A)\varphi + \lambda e^{\lambda \cdot} c - \lambda e^{\lambda \cdot} c - X_0(A_0c - \lambda c) = \psi + X_0a,$$

which has the solution

$$\begin{cases} \varphi = (\lambda I - A)^{-1} \psi, \\ c = (\lambda I - A_0)^{-1} a. \end{cases}$$

Consequently,

$$\begin{cases} (0, +\infty) \subset \rho(\tilde{A}), \\ (\lambda I - \tilde{A})^{-1} (\varphi + X_0c) = (\lambda I - A)^{-1} \varphi + e^{\lambda \cdot} (\lambda I - A_0)^{-1} c. \end{cases}$$

This complete the proof of the lemma ■

We now turn to the proof of the proposition. All we want to show is that $\frac{1}{\lambda} (\lambda I - \tilde{A})^{-1} \tilde{\varphi}$ can be expressed as the Laplace transform of $\tilde{S}(t)\tilde{\varphi}$. In view of the decomposition and what has been already done for A , we may restrict our attention to the case when $\tilde{\varphi} = X_0c$. In this case, we have

$$\begin{aligned} ((\lambda I - \tilde{A})^{-1} X_0c) (\theta) &= e^{\lambda\theta} (\lambda I - A_0)^{-1} c, \\ &= \lambda e^{\lambda\theta} \int_0^{+\infty} e^{-\lambda t} S_0(t) c dt, \\ &= \lambda \int_{-\theta}^{+\infty} e^{-\lambda t} S_0(t + \theta) c dt, \\ &= \lambda \int_0^{+\infty} e^{-\lambda t} (\tilde{S}(t) X_0c) (\theta) dt, \end{aligned}$$

which completes the proof of the proposition ■

We will need also the following general lemma.

Lemma 2 *Let $(U(t))_{t \geq 0}$ be a locally Lipschitz continuous integrated semi-group on a Banach space $(E, |\cdot|)$ generated by $(A, D(A))$ and $G : [0, T] \rightarrow E$ ($0 < T$), a Bochner-integrable function. Then, the function $K : [0, T] \rightarrow E$ defined by*

$$K(t) = \int_0^t U(t-s)G(s) ds$$

is continuously differentiable on $[0, T]$ and satisfies, for $t \in [0, T]$,

$$(i) \quad K'(t) = \lim_{h \rightarrow 0} \frac{1}{h} \int_0^t U'(t-s)U(h)G(s) ds = \lim_{\lambda \rightarrow +\infty} \int_0^t U'(t-s)(A_\lambda G(s)) ds,$$

with $A_\lambda = \lambda(\lambda I - A)^{-1}$,

(ii) $K(t) \in D(A)$,

(iii) $K'(t) = AK(t) + \int_0^t G(s) ds$.

Proof. Theorem 4 implies that K is continuously differentiable on $[0, T]$, and for the prove of (ii) and (iii), see [61], [76] and [92]. On the other hand, we know by the definition of an integrated semigroup that

$$U(t)U(h)x = \int_0^t (U(s+h)x - U(s)x) ds,$$

for $t, h \geq 0$ and $x \in E$. This yields that the function $t \rightarrow U(t)U(h)x$ is continuously differentiable on $[0, T]$, for each $h \geq 0$; $x \in E$, and satisfies

$$U'(t)U(h)x = U(t+h)x - U(t)x.$$

Furthermore, we have

$$K'(t) = \lim_{h \rightarrow 0} \left(\frac{1}{h} \int_0^t (U(t+h-s) - U(t-s)) G(s) ds + \frac{1}{h} \int_t^{t+h} U(t+h-s) G(s) ds \right).$$

If we put, in the second integral of the right-hand side, $u = \frac{1}{h}(s-t)$, we obtain

$$\frac{1}{h} \int_t^{t+h} U(t+h-s) G(s) ds = \int_0^1 U(h(1-u)) G(t+hu) du.$$

This implies that

$$\lim_{h \rightarrow 0} \frac{1}{h} \int_t^{t+h} U(t+h-s) G(s) ds = 0.$$

Hence

$$K'(t) = \lim_{h \rightarrow 0} \frac{1}{h} \int_0^t (U(t+h-s) - U(t-s)) G(s) ds.$$

But

$$U(t+h-s) - U(t-s) = U'(t-s)U(h).$$

It follows that, for $t \in [0, T]$

$$K'(t) = \lim_{h \rightarrow 0} \int_0^t U'(t-s) \frac{1}{h} U(h) G(s) ds.$$

For the prove of the last equality of (i), see [93] ■

We are now able to state a first result of existence and uniqueness of solutions.

Theorem 5 *Let $F : [0, T] \times \mathcal{C}_X \rightarrow X$ be continuous and satisfy a Lipschitz condition*

$$|F(t, \varphi) - F(t, \psi)| \leq L \|\varphi - \psi\|, \quad t \in [0, T] \text{ and } \varphi, \psi \in \mathcal{C}_X,$$

where L is a positive constant. Then, for given $\varphi \in \mathcal{C}_X$, such that $\varphi(0) \in \overline{D(A_0)}$, there exists a unique function $y : [0, T] \rightarrow \mathcal{C}_X$ which solves the following abstract integral equation

$$y(t) = S'(t)\varphi + \frac{d}{dt} \int_0^t \tilde{S}(t-s)X_0F(s, y(s)) ds, \quad \text{for } t \in [0, T], \quad (3.1)$$

with $(S(t))_{t \geq 0}$ given in Proposition 48 and $(\tilde{S}(t))_{t \geq 0}$ in Proposition 49.

Proof. Using the results of Theorem 4, the proof of this theorem is standard.

Since $\varphi(0) \in \overline{D(A_0)}$, we have $\varphi \in \overline{D(A)}$, where A is the generator of the integrated semigroup $(S(t))_{t \geq 0}$ on \mathcal{C}_X . Then, we deduce from Corollary 1 that $S(\cdot)\varphi$ is differentiable and $(S'(t))_{t \geq 0}$ can be defined to be a C_0 -semigroup on $\overline{D(A)}$.

Let $(y^n)_{n \in \mathbb{N}}$ be a sequence of continuous functions defined by

$$\begin{aligned} y^0(t) &= S'(t)\varphi, & t \in [0, T] \\ y^n(t) &= S'(t)\varphi + \frac{d}{dt} \int_0^t \tilde{S}(t-s)X_0F(s, y^{n-1}(s)) ds, & t \in [0, T], \quad n \geq 1. \end{aligned}$$

By virtue of the continuity of F and $S'(\cdot)\varphi$, there exists $\alpha \geq 0$ such that $|F(s, y^0(s))| \leq \alpha$, for $s \in [0, T]$. Then, using Theorem 4, we obtain

$$|y^1(t) - y^0(t)| \leq M_0 \int_0^t |F(s, y^0(s))| ds.$$

Hence

$$|y^1(t) - y^0(t)| \leq M_0\alpha t.$$

In general case we have

$$|y^n(t) - y^{n-1}(t)| \leq M_0L \int_0^t |y^{n-1}(s) - y^{n-2}(s)| ds.$$

So,

$$|y^n(t) - y^{n-1}(t)| \leq M_0^n L^{n-1} \alpha \frac{t^n}{n!}.$$

Consequently, the limit $y := \lim_{n \rightarrow \infty} y^n(t)$ exists uniformly on $[0, T]$ and $y : [0, T] \rightarrow \mathcal{C}_X$ is continuous.

In order to prove that y is a solution of Equation (3.1), we introduce the function v defined by

$$v(t) = \left| y(t) - S'(t)\varphi - \frac{d}{dt} \int_0^t \tilde{S}(t-s)X_0F(s, y(s)) ds \right|.$$

We have

$$\begin{aligned} v(t) &\leq \left| y(t) - y^{n+1}(t) \right| + \left| y^{n+1}(t) - S'(t)\varphi - \frac{d}{dt} \int_0^t \tilde{S}(t-s)X_0F(s, y(s)) ds \right|, \\ &\leq \left| y(t) - y^{n+1}(t) \right| + \left| \frac{d}{dt} \int_0^t \tilde{S}(t-s)X_0(F(s, y(s)) - F(s, y^n(s))) ds \right|, \\ &\leq \left| y(t) - y^{n+1}(t) \right| + M_0L \int_0^t |y(s) - y^n(s)| ds. \end{aligned}$$

Moreover, we have

$$y(t) - y^n(t) = \sum_{p=n}^{\infty} (y^{p+1}(t) - y^p(t)).$$

This implies that

$$v(t) \leq (1 + M_0L) \frac{\alpha}{L} \sum_{p=n}^{\infty} (M_0L)^{p+1} \frac{t^{p+1}}{(p+1)!} + \frac{\alpha}{L} (M_0L)^{n+1} \frac{t^{n+1}}{(n+1)!}, \text{ for } n \in \mathbb{N}.$$

Consequently we obtain $v = 0$ on $[0, T]$.

To show uniqueness, suppose that $z(t)$ is also a solution of Equation (3.1). Then

$$|y(t) - z(t)| \leq M_0L \int_0^t |y(s) - z(s)| ds.$$

By Gronwall's inequality, $z = y$ on $[0, T]$ ■

Corollary 6 *Under the same assumptions as in Theorem 5, the solution $y : [0, T] \rightarrow \mathcal{C}_X$ of the abstract integral equation (3.1) is the unique integral solution of the equation*

$$\begin{cases} y'(t) = \tilde{A}y(t) + X_0F(t, y(t)), & t \geq 0, \\ y(0) = \varphi \in \mathcal{C}_X, \end{cases}$$

i.e.

(i) $y \in \mathcal{C}([0, T]; \mathcal{C}_X)$,

(ii) $\int_0^t y(s)ds \in D(\tilde{A})$, for $t \in [0, T]$,

(iii) $y(t) = \varphi + \tilde{A} \int_0^t y(s)ds + X_0 \int_0^t F(s, y(s))ds$, for $t \in [0, T]$,

where the operator \tilde{A} is given in Proposition 49. Furthermore, we have, for $t \in [0, T]$,

$$\|y(t)\| \leq M_0 \left(\|\varphi\| + \int_0^t |F(s, y(s))| ds \right).$$

Proof. If we define the function $f : [0, T] \rightarrow \tilde{\mathcal{C}}_X$ by $f(s) = X_0 F(s, y(s))$, we can use Theorem 4 and Theorem 5 to prove this result ■

Corollary 7 *Under the same assumptions as in Theorem 5, the solution y of the integral equation (3.1) satisfies, for $t \in [0, T]$ and $\theta \in [-r, 0]$ the translation property*

$$y(t)(\theta) = \begin{cases} y(t + \theta)(0) & \text{if } t + \theta \geq 0, \\ \varphi(t + \theta) & \text{if } t + \theta \leq 0. \end{cases}$$

Moreover, if we consider the function $u : [-r, T] \rightarrow X$ defined by

$$u(t) = \begin{cases} y(t)(0) & \text{if } t \geq 0, \\ \varphi(t) & \text{if } t \leq 0. \end{cases}$$

Then, u is the unique integral solution of the problem (1.1), i.e.

$$\left\{ \begin{array}{l} \text{(i)} \ u \in \mathcal{C}([-r, T]; X), \\ \text{(ii)} \ \int_0^t u(s) ds \in D(A_0), \quad \text{for } t \in [0, T], \\ \text{(iii)} \ u(t) = \begin{cases} \varphi(0) + A_0 \int_0^t u(s) ds + \int_0^t F(s, u_s) ds, & \text{for } t \in [0, T], \\ \varphi(t), & \text{for } t \in [-r, 0]. \end{cases} \end{array} \right. \tag{3.2}$$

The function $u \in \mathcal{C}([-r, T]; X)$ is also the unique solution of

$$u(t) = \begin{cases} S'_0(t)\varphi(0) + \frac{d}{dt} \int_0^t S_0(t-s)F(s, u_s) ds, & \text{for } t \in [0, T], \\ \varphi(t), & \text{for } t \in [-r, 0]. \end{cases} \tag{3.3}$$

Furthermore, we have for $t \in [0, T]$

$$\|u_t\| \leq M_0 \left(\|\varphi\| + \int_0^t |F(s, u_s)| ds \right).$$

Conversely, if u is an integral solution of Equation (1.1), then the function $t \mapsto u_t$ is a solution of Equation (3.1).

Proof. From Proposition 48 and Proposition 49, we have for $t + \theta \geq 0$

$$\begin{aligned} y(t)(\theta) &= S'_0(t + \theta)\varphi(0) + \frac{d}{dt} \int_0^{t+\theta} S_0(t + \theta - s)F(s, y(s)) ds, \\ &= y(t + \theta)\varphi(0), \end{aligned}$$

and for $t + \theta \leq 0$, we obtain $\int_0^t (\tilde{S}(t - s)X_0F(s, y(s))) (\theta) ds = 0$ and $(S'(t)\varphi) (\theta) = \varphi(t + \theta)$. Hence

$$y(t)(\theta) = \varphi(t + \theta).$$

The second part of the corollary follows from Corollary 6 ■

Remark 8 A continuous function u from $[-r, T]$ into X is called an integral solution of Equation (1.1) if the function $t \mapsto u_t$ satisfies Equation (3.1) or equivalently u satisfies (3.2) or equivalently u satisfies (3.3).

Corollary 9 Assume that the hypotheses of Theorem 5 are satisfied and let u, \hat{u} be the functions given by Corollary 7 for $\varphi, \hat{\varphi} \in \mathcal{C}_X$, respectively. Then, for $t \in [0, T]$

$$\|u_t - \hat{u}_t\| \leq M_0 e^{Lt} \|\varphi - \hat{\varphi}\|.$$

Proof. This is just a consequence of the last inequality stated in Corollary 7. After the equation (3.1) has been centered near u , we obtain the equation

$$v(t) = S'(t) (\hat{\varphi} - \varphi) + \frac{d}{dt} \int_0^t \tilde{S}(t - s)X_0 (F(s, u_s + v(s)) - F(s, u_s)) ds,$$

with

$$v(t) = \hat{u}_t - u_t.$$

This yields

$$\|v(t)\| \leq M_0 \left(\|\varphi - \hat{\varphi}\| + \int_0^t |F(s, u_s) - F(s, \hat{u}_s)| ds \right),$$

this is

$$\|u_t - \hat{u}_t\| \leq M_0 \left(\|\varphi - \hat{\varphi}\| + L \int_0^t \|u_s - \hat{u}_s\| ds \right).$$

By Gronwall's inequality, we obtain

$$\|u_t - \hat{u}_t\| \leq M_0 e^{Lt} \|\varphi - \hat{\varphi}\| \quad \blacksquare$$

We give now two results of regularity of the integral solutions of (1.1).

Theorem 10 Assume that $F : [0, T] \times \mathcal{C}_X \rightarrow X$ is continuously differentiable and there exist constants $L, \beta, \gamma \geq 0$ such that

$$\begin{aligned} |F(t, \varphi) - F(t, \psi)| &\leq L \|\varphi - \psi\|, \\ |D_t F(t, \varphi) - D_t F(t, \psi)| &\leq \beta \|\varphi - \psi\|, \\ |D_\varphi F(t, \varphi) - D_\varphi F(t, \psi)| &\leq \gamma \|\varphi - \psi\|, \end{aligned}$$

for all $t \in [0, T]$ and $\varphi, \psi \in \mathcal{C}_X$, where $D_t F$ and $D_\varphi F$ denote the derivatives.

Then, for given $\varphi \in \mathcal{C}_X$ such that

$$\varphi(0) \in D(A_0), \quad \varphi' \in \mathcal{C}_X, \quad \varphi'(0) \in \overline{D(A_0)} \text{ and } \varphi'(0) = A_0\varphi(0) + F(0, \varphi),$$

let $y : [0, T] \rightarrow \mathcal{C}_X$ be the solution of the abstract integral equation (3.1) such that $y(0) = \varphi$. Then, y is continuously differentiable on $[0, T]$ and satisfies the Cauchy problem

$$\begin{cases} y'(t) = \tilde{A}y(t) + X_0F(t, y(t)), & t \in [0, T], \\ y(0) = \varphi. \end{cases}$$

Moreover, the function u defined on $[-r, T]$ by

$$u(t) = \begin{cases} y(t)(0) & \text{if } t \geq 0, \\ \varphi(t) & \text{if } t < 0, \end{cases}$$

is continuously differentiable on $[-r, T]$ and satisfies the Cauchy problem (1.1).

Proof. Let y be the solution of Equation (3.1) on $[0, T]$ such that $y(0) = \varphi$. We deduce from Theorem 5 that there exists a unique function $v : [0, T] \rightarrow \mathcal{C}_X$ which solves the following integral equation

$$v(t) = S'(t)\varphi' + \frac{d}{dt} \int_0^t \tilde{S}(t-s)X_0(D_t F(s, y(s)) + D_\varphi F(s, y(s))v(s)) ds,$$

such that $v(0) = \varphi'$.

Let $w : [0, T] \rightarrow \mathcal{C}_X$ be the function defined by

$$w(t) = \varphi + \int_0^t v(s) ds, \quad \text{for } t \in [0, T].$$

We will show that $w = y$ on $[0, T]$.

Using the expression satisfied by v , we obtain

$$\begin{aligned} w(t) &= \varphi + \int_0^t S'(s)\varphi' ds \\ &\quad + \int_0^t \tilde{S}(t-s)X_0(D_t F(s, y(s)) + D_\varphi F(s, y(s))v(s)) ds, \\ &= \varphi + S(t)\varphi' + \int_0^t \tilde{S}(t-s)X_0(D_t F(s, y(s)) + D_\varphi F(s, y(s))v(s)) ds. \end{aligned}$$

On the other hand, we have $\varphi \in D(\tilde{A})$ and $\varphi'(0) = A_0\varphi(0) + F(0, \varphi)$, then $\varphi' = \tilde{A}\varphi + X_0F(0, \varphi)$. This implies that

$$S(t)\varphi' = \tilde{S}(t)\varphi' = \tilde{S}(t)\tilde{A}\varphi + \tilde{S}(t)X_0F(0, \varphi).$$

Using Corollary 1, we deduce that

$$S(t)\varphi' = S'(t)\varphi - \varphi + \tilde{S}(t)X_0F(0, \varphi).$$

Furthermore, we have

$$\begin{aligned} \frac{d}{dt} \int_0^t \tilde{S}(t-s)X_0F(s, w(s)) ds &= \frac{d}{dt} \int_0^t \tilde{S}(s)X_0F(s, w(t-s)) ds \\ &= \int_0^t \tilde{S}(t-s)X_0 [D_tF(s, w(s)) + D_\varphi F(s, w(s))] v(s) ds + \tilde{S}(t)X_0F(0, \varphi). \end{aligned}$$

Then

$$\begin{aligned} w(t) &= S'(t)\varphi + \frac{d}{dt} \int_0^t \tilde{S}(t-s)X_0F(s, w(s)) ds \\ &\quad - \int_0^t \tilde{S}(t-s)X_0 (D_tF(s, w(s)) + D_\varphi F(s, w(s)))v(s) ds \\ &\quad + \int_0^t \tilde{S}(t-s)X_0 (D_tF(s, y(s)) + D_\varphi F(s, y(s)))v(s) ds, \\ &= S'(t)\varphi + \frac{d}{dt} \int_0^t \tilde{S}(t-s)X_0F(s, w(s)) ds \\ &\quad + \int_0^t \tilde{S}(t-s)X_0 (D_tF(s, y(s)) - D_tF(s, w(s))) ds \\ &\quad + \int_0^t \tilde{S}(t-s)X_0 (D_\varphi F(s, y(s)) - D_\varphi F(s, w(s)))v(s) ds. \end{aligned}$$

We obtain

$$\begin{aligned} w(t) - y(t) &= \frac{d}{dt} \int_0^t \tilde{S}(t-s)X_0 (F(s, w(s)) - F(s, y(s))) ds \\ &\quad + \int_0^t \tilde{S}(t-s)X_0 (D_tF(s, y(s)) - D_tF(s, w(s))) ds \\ &\quad + \int_0^t \tilde{S}(t-s)X_0 (D_\varphi F(s, y(s)) - D_\varphi F(s, w(s)))v(s) ds. \end{aligned}$$

So, we deduce

$$|w(t) - y(t)| \leq M_0 \int_0^t (L + \beta + \gamma |v(s)|) |w(s) - y(s)| ds.$$

By Gronwall's inequality, we conclude that $w = y$ on $[0, T]$. This implies that y is continuously differentiable on $[0, T]$.

Consider now the function $g : [0, T] \rightarrow \tilde{C}_X$ defined by $g(t) = X_0F(t, y(t))$ and consider the Cauchy problem

$$\begin{cases} z'(t) = \tilde{A}z(t) + g(t), & t \in [0, T], \\ z(0) = \varphi. \end{cases} \tag{3.4}$$

The assumptions of Theorem 10 imply that $\varphi \in D(\tilde{A})$, $\tilde{A}\varphi + g(0) \in \overline{D(\tilde{A})}$ and g is continuously differentiable on $[0, T]$. Using Theorem 3, we

deduce that there exists a unique solution on $[0, T]$ of Equation (3.4). By Theorem 4, we know that this solution is given by

$$z(t) = S'(t)\varphi + \frac{d}{dt} \int_0^t \tilde{S}(t-s)g(s)ds.$$

Theorem 5 implies that $z = y$ on $[0, T]$.

If we consider the function u defined on $[-r, T]$ by

$$u(t) = \begin{cases} y(t)(0) & \text{if } t \geq 0, \\ \varphi(t) & \text{if } t < 0. \end{cases}$$

By virtue of Corollary 7, we have $\int_0^t u(s)ds \in D(A_0)$ and

$$u(t) = \varphi(0) + A_0 \int_0^t u(s)ds + \int_0^t F(s, u_s)ds, \quad \text{for } t \in [0, T].$$

We have also the existence of

$$\lim_{h \rightarrow 0} A_0 \left(\frac{1}{h} \int_t^{t+h} u(s) ds \right) = u'(t) - F(t, u_t).$$

Furthermore, the operator A_0 is closed. Then, we obtain $u(t) \in D(A_0)$ and

$$u'(t) = A_0 u(t) + F(t, u_t), \quad \text{for } t \in [0, T].$$

The second part of the theorem is a consequence of Corollary 6 ■

Assume that $T > r$ and $A_0 : D(A_0) \subseteq X \rightarrow X$ satisfies (with not necessarily dense domain) the condition

$$\left\{ \begin{array}{l} \text{there exist } \beta \in]\frac{\pi}{2}, \pi[\text{ and } M_0 > 0 \text{ such that if} \\ \lambda \in \mathbb{C} - \{0\} \text{ and } |\arg \lambda| < \beta, \text{ then} \\ \left\| (\lambda I - A_0)^{-1} \right\| \leq \frac{M_0}{|\lambda|}. \end{array} \right. \quad (3.5)$$

The condition (3.5) is stronger than **(HY)**.

We have the following result.

Theorem 11 *Suppose that A_0 satisfies (3.5) (non-densely defined) on X and there exist a constant $L > 0$ and $\alpha \in]0, 1[$ such that*

$$|F(t, \psi) - F(s, \varphi)| \leq L (|t - s|^\alpha + \|\psi - \varphi\|)$$

for $t, s \in [0, T]$ and $\psi, \varphi \in \mathcal{C}_X$.

Then, for given $\varphi \in \mathcal{C}_X$, such that $\varphi(0) \in \overline{D(A_0)}$, the integral solution

u of Equation (1) on $[0, T]$ is continuously differentiable on $(r, T]$ and satisfies

$$\begin{aligned} u(t) &\in D(A_0), \quad u'(t) \in \overline{D(A_0)} \text{ and} \\ u'(t) &= A_0u(t) + F(t, u_t), \quad \text{for } t \in (r, T]. \end{aligned}$$

Proof. We know, from ([77], p.487) that A_0 is the generator of an analytic semigroup (not necessarily C_0 -semigroup) defined by

$$e^{A_0t} = \frac{1}{2\pi i} \int_{+C} e^{\lambda t} (\lambda I - A_0)^{-1} d\lambda, \quad t > 0$$

where $+C$ is a suitable oriented path in the complex plane.

Let u be the integral solution on $[0, T]$ of Equation (1), which exists by virtue of Theorem 5, and consider the function $g : [0, T] \rightarrow X$ defined by $g(t) = F(t, u_t)$. We deduce from ([89], p.106) that

$$u(t) = e^{A_0t} \varphi(0) + \int_0^t e^{A_0(t-s)} g(s) ds, \quad \text{for } t \in [0, T].$$

Using (Theorem 3.4, [91]), we obtain that the function u is γ -Hölder continuous on $[\varepsilon, T]$ for each $\varepsilon > 0$ and $\gamma \in]0, 1[$. Hence, there exists $L_1 \geq 0$ such that

$$\|u_t - u_s\| \leq L_1 |t - s|^\gamma, \quad \text{for } t, s \in (r, T].$$

On the other hand, we have

$$|g(t) - g(s)| \leq L(|t - s|^\alpha + \|u_t - u_s\|), \quad \text{for } t, s \in [0, T].$$

Consequently, the function $t \in (r, T] \rightarrow g(t)$ is locally Hölder continuous.

By virtue of (Theorem 4.4 and 4.5, [91]), we deduce that u is continuously differentiable on $(r, T]$ and satisfies

$$\begin{aligned} u(t) &\in D(A_0), \quad u'(t) \in \overline{D(A_0)} \text{ and} \\ u'(t) &= A_0u(t) + F(t, u_t), \quad \text{for } t \in (r, T] \quad \blacksquare \end{aligned}$$

We prove now the local existence of integral solutions of Problem (1.1) under a locally Lipschitz condition on F .

Theorem 12 *Suppose that $F : [0, +\infty) \times \mathcal{C}_X \rightarrow X$ is continuous and satisfies the following locally Lipschitz condition : for each $\alpha > 0$ there exists a constant $C_0(\alpha) > 0$ such that if $t \geq 0$, $\varphi_1, \varphi_2 \in \mathcal{C}_X$ and $\|\varphi_1\|, \|\varphi_2\| \leq \alpha$ then*

$$|F(t, \varphi_1) - F(t, \varphi_2)| \leq C_0(\alpha) \|\varphi_1 - \varphi_2\|.$$

Let $\varphi \in \mathcal{C}_X$ such that $\varphi(0) \in \overline{D(A_0)}$. Then, there exists a maximal interval of existence $[-r, T_\varphi[$, $T_\varphi > 0$, and a unique integral solution $u(\cdot, \varphi)$ of Equation (1.1), defined on $[-r, T_\varphi[$ and either

$$T_\varphi = +\infty \quad \text{or} \quad \lim_{t \rightarrow T_\varphi^-} \sup |u(t, \varphi)| = +\infty.$$

Moreover, $u(t, \varphi)$ is a continuous function of φ , in the sense that if $\varphi \in \mathcal{C}_X$, $\varphi(0) \in \overline{D(A_0)}$ and $t \in [0, T_\varphi[$, then there exist positive constants L and ε such that, for $\psi \in \mathcal{C}_X$, $\psi(0) \in \overline{D(A_0)}$ and $\|\varphi - \psi\| < \varepsilon$, we have

$$t \in [0, T_\psi[\text{ and } |u(s, \varphi) - u(s, \psi)| \leq L \|\varphi - \psi\|, \text{ for all } s \in [-r, t].$$

Proof. Let $T_1 > 0$. Note that the locally Lipschitz condition on F implies that, for each $\alpha > 0$ there exists $C_0(\alpha) > 0$ such that for $\varphi \in \mathcal{C}_X$ and $\|\varphi\| \leq \alpha$, we have

$$|F(t, \varphi)| \leq C_0(\alpha) \|\varphi\| + |F(t, 0)| \leq \alpha C_0(\alpha) + \sup_{s \in [0, T_1]} |F(s, 0)|.$$

Let $\varphi \in \mathcal{C}_X$, $\varphi(0) \in \overline{D(A_0)}$, $\alpha = \|\varphi\| + 1$ and $c_1 = \alpha C_0(\alpha) + \sup_{s \in [0, T_1]} |F(s, 0)|$.

Consider the following set

$$Z_\varphi = \left\{ u \in \mathcal{C}([-r, T_1], X) : u(s) = \varphi(s) \text{ if } s \in [-r, 0] \right. \\ \left. \text{and } \sup_{s \in [0, T_1]} |u(s) - \varphi(0)| \leq 1 \right\},$$

where $\mathcal{C}([-r, T_1], X)$ is endowed with the uniform convergence topology. It's clear that Z_φ is a closed set of $\mathcal{C}([-r, T_1], X)$. Consider the mapping

$$H : Z_\varphi \rightarrow \mathcal{C}([-r, T_1], X)$$

defined by

$$H(u)(t) = \begin{cases} S'_0(t)\varphi(0) + \frac{d}{dt} \int_0^t S_0(t-s)F(s, u_s)ds, & \text{for } t \in [0, T_1], \\ \varphi(t), & \text{for } t \in [-r, 0]. \end{cases}$$

We will show that

$$H(Z_\varphi) \subseteq Z_\varphi.$$

Let $u \in Z_\varphi$ and $t \in [0, T_1]$, we have, for suitable constants M_0 and ω_0

$$\begin{aligned} |H(u)(t) - \varphi(0)| &\leq |S'_0(t)\varphi(0) - \varphi(0)| + \left| \frac{d}{dt} \int_0^t S_0(t-s)F(s, u_s)ds \right|, \\ &\leq |S'_0(t)\varphi(0) - \varphi(0)| + M_0 e^{\omega_0 t} \int_0^t e^{-\omega_0 s} |F(s, u_s)| ds. \end{aligned}$$

We can assume, without loss of generality, that $\omega_0 > 0$. Then,

$$|H(u)(t) - \varphi(0)| \leq |S'_0(t)\varphi(0) - \varphi(0)| + M_0 e^{\omega_0 t} \int_0^t |F(s, u_s)| ds.$$

Since $|u(s) - \varphi(0)| \leq 1$, for $s \in [0, T_1]$, and $\alpha = \|\varphi\| + 1$, we obtain $|u(s)| \leq \alpha$, for $s \in [-r, T_1]$. Then, $\|u_s\| \leq \alpha$, for $s \in [0, T_1]$ and

$$\begin{aligned} |F(s, u_s)| &\leq C_0(\alpha) \|u_s\| + |F(s, 0)|, \\ &\leq c_1. \end{aligned}$$

Consider $T_1 > 0$ sufficiently small such that

$$\sup_{s \in [0, T_1]} \{ |S'_0(s)\varphi(0) - \varphi(0)| + M_0 e^{\omega_0 s} c_1 s \} < 1.$$

So, we deduce that

$$\begin{aligned} |H(u)(t) - \varphi(0)| &\leq |S'_0(t)\varphi(0) - \varphi(0)| + M_0 e^{\omega_0 t} c_1 t \\ &< 1, \end{aligned}$$

for $t \in [0, T_1]$. Hence,

$$H(Z_\varphi) \subseteq Z_\varphi.$$

On the other hand, let $u, v \in Z_\varphi$ and $t \in [0, T_1]$, we have

$$\begin{aligned} |H(u)(t) - H(v)(t)| &= \left| \frac{d}{dt} \int_0^t S_0(t-s)(F(s, u_s) - F(s, v_s)) ds \right|, \\ &\leq M_0 e^{\omega_0 t} \int_0^t |F(s, u_s) - F(s, v_s)| ds, \\ &\leq M_0 e^{\omega_0 t} C_0(\alpha) \int_0^t \|u_s - v_s\| ds, \\ &\leq M_0 e^{\omega_0 T_1} C_0(\alpha) T_1 \|u - v\|_{C([-r, T_1], X)}. \end{aligned}$$

Note that $\alpha \geq 1$, then

$$\begin{aligned} M_0 e^{\omega_0 T_1} C_0(\alpha) T_1 &\leq M_0 e^{\omega_0 T_1} c_1 T_1, \\ &\leq \sup_{s \in [0, T_1]} \{ |S'_0(s)\varphi(0) - \varphi(0)| + M_0 e^{\omega_0 s} c_1 s \}, \\ &< 1. \end{aligned}$$

Then, H is a strict contraction in Z_φ . So, H has one and only one fixed point u in Z_φ . We conclude that Equation (1.1) has one and only one integral solution which is defined on the interval $[-r, T_1]$.

Let $u(\cdot, \varphi)$ be the unique integral solution of Equation (1.1), defined on it's maximal interval of existence $[0, T_\varphi[$, $T_\varphi > 0$.

Assume that $T_\varphi < +\infty$ and $\limsup_{t \rightarrow T_\varphi^-} |u(t, \varphi)| < +\infty$. Then, there exists a constant $\alpha > 0$ such that $\|u(t, \varphi)\| \leq \alpha$, for $t \in [-r, T_\varphi[$. Let $t, t + h \in [0, T_\varphi[$, $h > 0$, and $\theta \in [-r, 0]$. If $t + \theta \geq 0$, we obtain

$$\begin{aligned} &|u(t + \theta + h, \varphi) - u(t + \theta, \varphi)| \leq |(S'_0(t + \theta + h) - S'_0(t + \theta))\varphi(0)| \\ &+ \left| \frac{d}{dt} \int_0^{t+\theta+h} S_0(t + \theta + h - s)F(s, u_s(\cdot, \varphi))ds - \frac{d}{dt} \int_0^{t+\theta} S_0(t + \theta - s)F(s, u_s(\cdot, \varphi))ds \right|, \\ &\leq \|S'_0(t + \theta)\| |S'_0(h)\varphi(0) - \varphi(0)| + \left| \frac{d}{dt} \int_{t+\theta}^{t+\theta+h} S_0(s)F(t + \theta + h - s, u_{t+\theta+h-s}(\cdot, \varphi))ds \right| \\ &+ \left| \frac{d}{dt} \int_0^{t+\theta} S_0(s) (F(u_{t+\theta+h-s}, \varphi) - F(t + \theta - s, u_{t+\theta-s}(\cdot, \varphi))) ds \right|. \end{aligned}$$

This implies that,

$$\begin{aligned} |u_{t+h}(\theta, \varphi) - u_t(\theta, \varphi)| &\leq M_0 e^{\omega_0 T_\varphi} |S'_0(h)\varphi(0) - \varphi(0)| + M_0 e^{\omega_0 T_\varphi} c_1 h \\ &+ M_0 e^{\omega_0 T_\varphi} C_0(\alpha) \int_0^t \|u_{s+h}(\cdot, \varphi) - u_s(\cdot, \varphi)\| ds. \end{aligned}$$

If $t + \theta < 0$. Let $h_0 > 0$ sufficiently small such that, for $h \in]0, h_0[$

$$|u_{t+h}(\theta, \varphi) - u_t(\theta, \varphi)| \leq \sup_{-r \leq \sigma \leq 0} |u(\sigma + h, \varphi) - u(\sigma, \varphi)|.$$

Consequently, for $t, t + h \in [0, T_\varphi[$, $h \in]0, h_0[$;

$$\begin{aligned} \|u_{t+h}(\cdot, \varphi) - u_t(\cdot, \varphi)\| &\leq \delta(h) + M_0 e^{\omega_0 T_\varphi} (|S'_0(h)\varphi(0) - \varphi(0)| + c_1 h) \\ &+ M_0 e^{\omega_0 T_\varphi} C_0(\alpha) \int_0^t \|u_{s+h}(\cdot, \varphi) - u_s(\cdot, \varphi)\| ds, \end{aligned}$$

where

$$\delta(h) = \sup_{-r \leq \sigma \leq 0} |u(\sigma + h, \varphi) - u(\sigma, \varphi)|.$$

By Gronwall's Lemma, it follows

$$\|u_{t+h}(\cdot, \varphi) - u_t(\cdot, \varphi)\| \leq \beta(h) \exp [C_0(\alpha) M_0 e^{\omega_0 T_\varphi} T_\varphi],$$

with

$$\beta(h) = \delta(h) + M_0 e^{\omega_0 T_\varphi} [|S'_0(h)\varphi(0) - \varphi(0)| + c_1 h].$$

Using the same reasoning, one can show the same result for $h < 0$. It follows immediately, that

$$\lim_{t \rightarrow T_\varphi^-} u(t, \varphi) \text{ exists.}$$

Consequently, $u(\cdot, \varphi)$ can be extended to T_φ , which contradicts the maximality of $[0, T_\varphi[$.

We will prove now that the solution depends continuously on the initial data. Let $\varphi \in \mathcal{C}_X$, $\varphi(0) \in \overline{D(A_0)}$ and $t \in [0, T_\varphi[$. We put

$$\alpha = 1 + \sup_{-r \leq s \leq t} |u(s, \varphi)|$$

and

$$c(t) = M_0 e^{\omega_0 t} \exp(M_0 e^{\omega_0 t} C_0(\alpha) t).$$

Let $\varepsilon \in]0, 1[$ such that $c(t)\varepsilon < 1$ and $\psi \in \mathcal{C}_X$, $\psi(0) \in \overline{D(A_0)}$ such that

$$\|\varphi - \psi\| < \varepsilon.$$

We have

$$\|\psi\| \leq \|\varphi\| + \varepsilon < \alpha.$$

Let

$$T_0 = \sup \{s > 0 : \|u_\sigma(\cdot, \psi)\| \leq \alpha \text{ for } \sigma \in [0, s]\}.$$

If we suppose that $T_0 < t$, we obtain for $s \in [0, T_0]$,

$$\|u_s(\cdot, \varphi) - u_s(\cdot, \psi)\| \leq M_0 e^{\omega_0 t} \|\varphi - \psi\| + M_0 e^{\omega_0 t} C_0(\alpha) \int_0^s \|u_\sigma(\cdot, \varphi) - u_\sigma(\cdot, \psi)\| d\sigma.$$

By Gronwall's Lemma, we deduce that

$$\|u_s(\cdot, \varphi) - u_s(\cdot, \psi)\| \leq c(t) \|\varphi - \psi\|. \tag{3.6}$$

This implies that

$$\|u_s(\cdot, \psi)\| \leq c(t)\varepsilon + \alpha - 1 < \alpha, \text{ for all } s \in [0, T_0].$$

It follows that T_0 cannot be the largest number $s > 0$ such that $\|u_\sigma(\cdot, \psi)\| \leq \alpha$, for $\sigma \in [0, s]$. Thus, $T_0 \geq t$ and $t < T_\psi$. Furthermore, $\|u_s(\cdot, \psi)\| \leq \alpha$, for $s \in [0, t]$, then using the inequality (3.6) we deduce the dependence continuous with the initial data. This completes the proof of Theorem

■

Theorem 13 *Assume that F is continuously differentiable and satisfies the following locally Lipschitz condition: for each $\alpha > 0$ there exists a constant $C_1(\alpha) > 0$ such that if $\varphi_1, \varphi_2 \in \mathcal{C}_X$ and $\|\varphi_1\|, \|\varphi_2\| \leq \alpha$ then*

$$\begin{aligned} |F(t, \varphi_1) - F(t, \varphi_2)| &\leq C_1(\alpha) \|\varphi_1 - \varphi_2\|, \\ |D_t F(t, \varphi_1) - D_t F(t, \varphi_2)| &\leq C_1(\alpha) \|\varphi_1 - \varphi_2\|, \\ |D_\varphi F(t, \varphi_1) - D_\varphi F(t, \varphi_2)| &\leq C_1(\alpha) \|\varphi_1 - \varphi_2\|. \end{aligned}$$

Then, for given $\varphi \in \mathcal{C}_X^1 := \mathcal{C}^1([-r, 0], X)$ such that

$$\varphi(0) \in D(A_0), \quad \varphi'(0) \in \overline{D(A_0)} \text{ and } \varphi'(0) = A\varphi(0) + F(\varphi),$$

let $u(\cdot, \varphi) : [-r, T_\varphi[\rightarrow X$ be the unique integral solution of Equation (1.1). Then, $u(\cdot, \varphi)$ is continuously differentiable on $[-r, T_\varphi[$ and satisfies Equation (1.1).

Proof. The proof is similar to the proof of Theorem 10 ■

4. The semigroup and the integrated semigroup in the autonomous case

Let E be defined by

$$E := \overline{D(A)}^{\mathcal{C}^X} = \left\{ \varphi \in \mathcal{C}_X : \varphi(0) \in \overline{D(A_0)} \right\}.$$

Throughout this section we will suppose the hypothesis of Theorem 5 except that we require F to be autonomous, that is, $F : \mathcal{C}_X \rightarrow X$. By virtue of Theorem 5, there exists for each $\varphi \in E$ a unique continuous function $y(\cdot, \varphi) : [0, +\infty) \rightarrow X$ satisfying the following equation

$$y(t) = S'(t)\varphi + \frac{d}{dt} \int_0^t \tilde{S}(t-s)X_0F(y(s)) ds, \quad \text{for } t \geq 0. \quad (4.1)$$

Let us consider the operator $T(t) : E \rightarrow E$ defined, for $t \geq 0$ and $\varphi \in E$, by

$$T(t)(\varphi) = y(t, \varphi).$$

Then, we have the following result.

Proposition 50 *Under the same assumptions as in Theorem 5, the family $(T(t))_{t \geq 0}$ is a nonlinear strongly continuous semigroup of continuous operators on E , that is*

- i) $T(0) = Id$,
- ii) $T(t + s) = T(t)T(s)$, for all $t, s \geq 0$,
- iii) for all $\varphi \in E$, $T(t)(\varphi)$ is a continuous function of $t \geq 0$ with values in E ,
- iv) for all $t \geq 0$, $T(t)$ is continuous from E into E .

Moreover,

- v) $(T(t))_{t \geq 0}$ satisfies, for $t \geq 0$, $\theta \in [-r, 0]$ and $\varphi \in E$, the translation property

$$(T(t)(\varphi))(\theta) = \begin{cases} (T(t + \theta)(\varphi))(0), & \text{if } t + \theta \geq 0, \\ \varphi(t + \theta), & \text{if } t + \theta \leq 0, \end{cases} \quad (4.2)$$

and

- vi) there exists $\gamma > 0$ and $M \geq 0$ such that,

$$\|T(t)(\varphi_1) - T(t)(\varphi_2)\| \leq Me^{\gamma t} \|\varphi_1 - \varphi_2\|, \text{ for all } \varphi_1, \varphi_2 \in E.$$

Proof. The proof of this proposition is standard.

We recall the following definition.

Definition 48 *A C_0 -semigroup $(T(t))_{t \geq 0}$ on a Banach space $(X, |\cdot|)$ is called compact if all operators $T(t)$ are compact on X for $t > 0$.*

Lemma 49 *Let $(S(t))_{t \geq 0}$ a locally Lipschitz continuous integrated semigroup on a Banach space $(X, |\cdot|)$, $(A, D(A))$ its generator, B a bounded subset of X , $\{G_\lambda, \lambda \in \Lambda\}$ a set of continuous functions from the finite interval $[0, T]$ into B , $c > 0$ a constant and*

$$P_\lambda(t) = \frac{d}{dt} \int_0^{t-c} S(t-s)G_\lambda(s) ds, \quad \text{for } c < t \leq T + c \text{ and } \lambda \in \Lambda.$$

Assume that $S'(t) : (\overline{D(A)}, |\cdot|) \rightarrow (\overline{D(A)}, |\cdot|)$ is compact for each $t > 0$. Then, for each $t \in (c, T + c]$, $\{P_\lambda(t), \lambda \in \Lambda\}$ is a precompact subset of $(\overline{D(A)}, |\cdot|)$.

Proof. The proof is similar to the proof of a fundamental result of Travis and Webb [94]. Let $H = \{S'(t)x; t \in [c, T + c], x \in \overline{D(A)}, |x| \leq kN\}$, where k is the Lipschitz constant of $S(\cdot)$ on $[0, T]$ and N is a bound of B . Using the same reasoning as in the proof of Lemma 2.5 [94], one can prove that H is precompact in $(\overline{D(A)}, |\cdot|)$. Hence, the convex hull of H is precompact. On the other hand, we have, from Lemma 2

$$P_\lambda(t) = \lim_{h \searrow 0} \frac{1}{h} \int_0^{t-c} S'(t-s)S(h)G_\lambda(s) ds,$$

and, for each $h > 0$ small enough and $t \in (c, T + c]$ fixed, the set

$$\left\{ S'(s) \frac{1}{h} S(h)G_\lambda(t-s), s \in [c, t], \lambda \in \Lambda \right\}$$

is contained in H . Then, the set

$$\left\{ \frac{1}{h} \int_c^t S'(s)S(h)G_\lambda(t-s) ds, \lambda \in \Lambda \right\}$$

is contained in the closed convex hull of $(t-c)H$. Letting h tend to zero, the set

$$\{P_\lambda(t), \lambda \in \Lambda\}$$

is still a precompact set of $\overline{D(A)}$. Hence the proof is complete ■

Theorem 14 *Assume that $S'_0(t) : (\overline{D(A_0)}, |\cdot|) \rightarrow (\overline{D(A_0)}, |\cdot|)$ is compact for each $t > 0$ and the assumptions of Theorem 5 are satisfied. Then, the nonlinear semigroup $(T(t))_{t \geq 0}$ is compact on $(E, \|\cdot\|_{C_X})$ for every $t > r$.*

Proof. Let $\{\varphi_\lambda, \lambda \in \Lambda\}$ be a bounded subset of E and let $t > r$. For $\theta \in [-r, 0]$, we have $t + \theta > 0$. For each $\lambda \in \Lambda$, define y_λ by

$$y_\lambda(t)(\theta) = y(t, \varphi_\lambda)(\theta).$$

Then, we obtain

$$\begin{aligned} y_\lambda(t)(\theta) &= S'_0(t + \theta)\varphi_\lambda(0) + \frac{d}{dt} \int_0^{t+\theta} S_0(t + \theta - s)F(y_\lambda(s)) ds, \\ &= S'_0(t + \theta)\varphi_\lambda(0) + \lim_{h \searrow 0} \frac{1}{h} \int_0^{t+\theta} S'_0(t + \theta - s)S_0(h)F(y_\lambda(s)) ds. \end{aligned}$$

First, we show that the family $\{y_\lambda(t), \lambda \in \Lambda\}$ is equicontinuous, for each $t > r$. Using the Lipschitz condition on F , one shows that $\{F(y_\lambda(s)), s \in [0, t]$ and $\lambda \in \Lambda\}$ is bounded by a constant, say K .

Let $\lambda \in \Lambda, 0 < c < t - r$ and $-r \leq \hat{\theta} < \theta \leq 0$. Observe that

$$\begin{aligned} &\left| y_\lambda(t)(\theta) - y_\lambda(t)(\hat{\theta}) \right| \leq \left| S'_0(t + \theta)\varphi_\lambda(0) - S'_0(t + \hat{\theta})\varphi_\lambda(0) \right| \\ &\quad + \lim_{h \searrow 0} \frac{1}{h} \left| \int_{t+\hat{\theta}}^{t+\theta} S'_0(t + \theta - s)S_0(h)F(y_\lambda(s)) ds \right| \\ &\quad + \lim_{h \searrow 0} \frac{1}{h} \left| \int_{t+\hat{\theta}-c}^{t+\hat{\theta}} (S'_0(t + \theta - s) - S'_0(t + \hat{\theta} - s)) S_0(h)F(y_\lambda(s)) ds \right| \\ &\quad + \lim_{h \searrow 0} \frac{1}{h} \left| \int_0^{t+\hat{\theta}-c} (S'_0(t + \theta - s) - S'_0(t + \hat{\theta} - s)) S_0(h)F(y_\lambda(s)) ds \right|, \\ &\leq \left\| S'_0(t + \theta) - S'_0(t + \hat{\theta}) \right\| |\varphi_\lambda(0)| + M_0 e^{\omega_0 t} kK \left| \theta - \hat{\theta} \right| + c2M_0 e^{\omega_0 t} kK \\ &\quad + t \sup_{s \in [0, t+\hat{\theta}-c]} \left\| S'_0(t + \theta - s) - S'_0(t + \hat{\theta} - s) \right\| kK. \end{aligned}$$

If we take $\left| \theta - \hat{\theta} \right|$ small enough, it follows from the uniform continuity of $S'_0(\cdot) : [a, t] \rightarrow \mathcal{L}(\overline{D(A_0)})$ for $0 < a < t$, the claimed equicontinuity of $\{y_\lambda(t), \lambda \in \Lambda\}$.

On the other hand, the family $\{S'_0(t + \theta)\varphi_\lambda(0); \lambda \in \Lambda\}$ is precompact, for each $t > r$ and $\theta \in [-r, 0]$. We will show that, for each $t > r$ and $\theta \in [-r, 0]$.

$$\left\{ \frac{d}{dt} \int_0^{t+\theta} S_0(t + \theta - s)F(y_\lambda(s)) ds; \lambda \in \Lambda \right\}$$

is precompact.

Observe that for $0 < c < t + \theta$ and $\lambda \in \Lambda$

$$\frac{1}{h} \left| \int_{t+\theta-c}^{t+\theta} S'_0(t + \theta - s)S_0(h)F(y_\lambda(s)) ds \right| \leq cM_0 e^{\omega_0 t} kK.$$

Then, if h tends to zero we obtain

$$\left| \frac{d}{dt} \int_{t+\theta-c}^{t+\theta} S_0(t + \theta - s)F(y_\lambda(s)) ds \right| \leq cM_0 e^{\omega_0 t} kK. \tag{4.3}$$

For $0 < c < t + \theta$ and $\lambda \in \Lambda$,

$$\int_0^{t+\theta-c} S_0(t + \theta - s)F(y_\lambda(s)) ds = \int_c^{t+\theta} S_0(s)F(y_\lambda(t + \theta - s)) ds.$$

By Lemma 49, if $0 < c < t + \theta$ and $\lambda \in \Lambda$, then

$$\left\{ \frac{d}{dt} \int_0^{t+\theta-c} S_0(t + \theta - s)F(y_\lambda(s)) ds, \quad \lambda \in \Lambda \right\}$$

is precompact in X , for each $t > r$ and $\theta \in [-r, 0]$. This fact together with (4.3) yields the precompactness of the set

$$\left\{ \frac{d}{dt} \int_0^{t+\theta} S_0(t + \theta - s)F(y_\lambda(s)) ds, \quad \lambda \in \Lambda \right\}.$$

Using the Arzela-Ascoli theorem, we obtain the result of Theorem 14 ■

Consider now the linear autonomous functional differential equation

$$\begin{cases} u'(t) = A_0u(t) + L(u_t), & t \geq 0, \\ u_0 = \varphi, \end{cases} \tag{4.4}$$

where L is a continuous linear functional from \mathcal{C}_X into X .

Given $\varphi \in \mathcal{C}_X$. It is clear that there exists a unique function $z := z(\cdot, \varphi) : [0, +\infty) \rightarrow \mathcal{C}_X$ which solves the following abstract integral equation

$$z(t) = S(t)\varphi + \frac{d}{dt} \left(\int_0^t \tilde{S}(t-s)X_0L(z(s)) ds \right), \quad \text{for } t \geq 0. \tag{4.5}$$

Theorem 15 *The family of operators $(U(t))_{t \geq 0}$ defined on \mathcal{C}_X by*

$$U(t)\varphi = z(t, \varphi),$$

is a locally Lipschitz continuous integrated semigroup on \mathcal{C}_X generated by the operator P defined by

$$\begin{cases} D(P) = \{ \varphi \in C^1([-r, 0], X); \varphi(0) \in D(A_0), \\ \quad \varphi'(0) = A_0\varphi(0) + L(\varphi) \}, \\ P\varphi = \varphi'. \end{cases}$$

Proof. Consider the operator

$$\tilde{L} : \mathcal{C}_X \rightarrow \tilde{\mathcal{C}}_X$$

defined by

$$\tilde{L}(\varphi) = X_0L(\varphi).$$

Using a result of Kellermann [80], one can prove that the operator \tilde{G} defined in $\tilde{\mathcal{C}}_X$ by

$$\begin{cases} D(\tilde{G}) = D(\tilde{A}), \\ \tilde{G} = \tilde{A} + \tilde{L}, \end{cases}$$

where \tilde{A} is defined in Proposition 49, is the generator of a locally Lipschitz continuous integrated semigroup on $\tilde{\mathcal{C}}_X$, because \tilde{A} satisfies **(HY)** and $\tilde{L} \in \mathcal{L}(\mathcal{C}_X, \tilde{\mathcal{C}}_X)$.

Let us introduce the part G of \tilde{G} in \mathcal{C}_X , which is defined by :

$$\begin{cases} D(G) = \{ \varphi \in D(\tilde{G}); \tilde{G}\varphi \in \mathcal{C}_X \}, \\ G(\varphi) = \tilde{G}(\varphi). \end{cases}$$

It is easy to see that

$$G = P.$$

Then, P is the generator of a locally Lipschitz continuous integrated semigroup $(V(t))_{t \geq 0}$ on \mathcal{C}_X .

On the other hand, if we consider, for each $\varphi \in \mathcal{C}_X$, the nonhomogeneous Cauchy problem

$$\begin{cases} \frac{dz}{dt}(t) = \tilde{A}z(t) + h(t), \text{ for } t \geq 0, \\ z(0) = 0, \end{cases} \tag{4.6}$$

where $h : [0, +\infty[\rightarrow \tilde{\mathcal{C}}_X$ is given by

$$h(t) = \varphi + \tilde{L}(V(t)\varphi).$$

By Theorem 4, the nonhomogeneous Cauchy problem (4.6) has a unique integral solution z given by

$$\begin{aligned} z(t) &= \frac{d}{dt} \left(\int_0^t \tilde{S}(t-s)h(s) ds \right), \\ &= \frac{d}{dt} \left(\int_0^t \tilde{S}(t-s)\varphi ds \right) + \frac{d}{dt} \left(\int_0^t \tilde{S}(t-s)X_0L(V(s)\varphi) ds \right). \end{aligned}$$

Then,

$$z(t) = S(t)\varphi + \frac{d}{dt} \left(\int_0^t \tilde{S}(t-s)X_0L(V(s)\varphi) ds \right).$$

On the other hand, Proposition 47 gives

$$V(t)\varphi = P \left(\int_0^t V(s)\varphi ds \right) + t\varphi.$$

Moreover, for $\psi \in D(P)$, we have

$$P\psi = \tilde{A}\psi + X_0L(\psi).$$

Then, we obtain

$$V(t)\varphi = \tilde{A} \left(\int_0^t V(s)\varphi ds \right) + X_0L \left(\int_0^t V(s)\varphi ds \right) + t\varphi.$$

So,

$$V(t)\varphi = \tilde{A} \left(\int_0^t V(s)\varphi ds \right) + \int_0^t h(s) ds.$$

Hence, the function $t \rightarrow V(t)\varphi$ is an integral solution of Equation (4.6). By uniqueness, we conclude that $V(t)\varphi = z(t)$, for all $t \geq 0$. Then we have $U(t) = V(t)$ on \mathcal{C}_X . Thus the proof of Theorem 15 ■

Let \mathcal{B} be the part of the operator P on E . Then,

$$\begin{cases} D(\mathcal{B}) = \left\{ \varphi \in C^1([-r, 0], X); \varphi(0) \in D(A_0), \varphi'(0) \in \overline{D(A_0)} \right. \\ \left. \varphi'(0) = A_0\varphi(0) + L(\varphi) \right\}, \\ \mathcal{B}\varphi = \varphi'. \end{cases}$$

Corollary 16 \mathcal{B} is the infinitesimal generator of the C_0 -semigroup $(U'(t))_{t \geq 0}$ on E .

Proof. See [93] ■

Corollary 17 Under the same assumptions as in Theorem 14, the linear C_0 -semigroup $(U'(t))_{t \geq 0}$ is compact on E , for every $t > r$.

To define a fundamental integral solution $Z(t)$ associated to Equation (4.4), we consider, for $\tilde{\varphi} \in \tilde{\mathcal{C}}_X$, the integral equation

$$z(t) = \tilde{S}(t)\tilde{\varphi} + \frac{d}{dt} \left(\int_0^t \tilde{S}(t-s)X_0L(z(s)) ds \right), \quad \text{for } t \geq 0. \quad (4.7)$$

One can show the following result.

Proposition 51 Given $\tilde{\varphi} \in \tilde{\mathcal{C}}_X$, the abstract integral equation (4.7) has a unique solution $z := z(\cdot, \tilde{\varphi})$ which is a continuous mapping from $[0, +\infty) \rightarrow \mathcal{C}_X$. Moreover, the family of operators $(\tilde{U}(t))_{t \geq 0}$ defined on $\tilde{\mathcal{C}}_X$ by

$$\tilde{U}(t)\tilde{\varphi} = z(t, \tilde{\varphi})$$

is a locally Lipschitz continuous integrated semigroup on $\tilde{\mathcal{C}}_X$ generated by the operator \tilde{G} defined by

$$\begin{cases} D(\tilde{G}) = D(\tilde{A}), \\ \tilde{G}\varphi = \tilde{A} + X_0L(\varphi). \end{cases}$$

For each complex number λ , we define the linear operator

$$\Delta(\lambda) : D(A_0) \rightarrow X$$

by

$$\Delta(\lambda)x := \lambda x - A_0x - L(e^{\lambda \cdot} x), \quad x \in D(A_0).$$

where $e^{\lambda \cdot} x : [-r, 0] \rightarrow \mathcal{C}_X$, is defined for $x \in X$ by (note that we consider here the complexification of \mathcal{C}_X)

$$(e^{\lambda \cdot} x)(\theta) = e^{\lambda\theta} x, \quad \theta \in [-r, 0].$$

We will call λ a characteristic value of Equation (4.4) if there exists $x \in D(A_0) \setminus \{0\}$ solving the characteristic equation $\Delta(\lambda)x = 0$. The multiplicity of a characteristic value λ of Equation (4.4) is defined as $\dim \text{Ker} \Delta(\lambda)$.

We have the following result.

Corollary 18 *There exists $\omega \in \mathbb{R}$, such that for $\lambda > \omega$ and $c \in X$, one has*

$$(\lambda I - \tilde{G})^{-1}(X_0c) = e^{\lambda \cdot} \Delta(\lambda)^{-1}c.$$

Proof. We have, for $\lambda > \omega_0$

$$\Delta(\lambda) = (\lambda I - A_0) \left(I - (\lambda I - A_0)^{-1} L(e^{\lambda \cdot} I) \right).$$

Let $\omega > \max(0, \omega_0 + M_0 \|L\|)$ and

$$K_\lambda = (\lambda I - A_0)^{-1} L(e^{\lambda \cdot} I).$$

Then,

$$\|K_\lambda\| \leq \frac{M_0 \|L\|}{\lambda - \omega_0} < 1, \quad \text{for } \lambda > \omega.$$

Hence the operator $\Delta(\lambda)$ is invertible for $\lambda > \omega$.

Consider the equation

$$(\lambda I - \tilde{G})(e^{\lambda \cdot} a) = X_0c,$$

where $c \in X$ is given and we are looking for $a \in D(A_0)$. This yields

$$\lambda e^{\lambda \cdot} c - \lambda e^{\lambda \cdot} c + X_0 \left(\lambda c - A_0 c - L \left(e^{\lambda \cdot} c \right) \right) = X_0 a.$$

Then, for $\lambda > \omega$

$$c = \Delta(\lambda)^{-1} a.$$

Consequently,

$$\left(\lambda I - \tilde{G} \right)^{-1} (X_0 c) = e^{\lambda \cdot} \Delta(\lambda)^{-1} c \quad \blacksquare$$

Corollary 19 For each $c \in X$, the function $\tilde{U}(\cdot)(X_0 c)$ satisfies, for $t \geq 0$ and $\theta \in [-r, 0]$, the following translation property

$$\left(\tilde{U}(t)(X_0 c) \right) (\theta) = \begin{cases} \left(\tilde{U}(t + \theta)(X_0 c) \right) (0), & t + \theta \geq 0, \\ 0, & t + \theta \leq 0. \end{cases}$$

We can consider the following linear operator

$$Z(t) : X \rightarrow X$$

defined, for $t \geq 0$ and $c \in X$, by

$$Z(t)c = \tilde{U}(t)(X_0 c)(0)$$

Corollary 20 $Z(t)$ is the fundamental integral solution of Equation (4.4); that is

$$\Delta(\lambda)^{-1} = \lambda \int_0^{+\infty} e^{-\lambda t} Z(t) dt, \quad \text{for } \lambda > \omega.$$

Proof. We have, for $c \in X$

$$\left(\lambda I - \tilde{G} \right)^{-1} (X_0 c) = e^{\lambda \cdot} \Delta(\lambda)^{-1} c.$$

Then

$$e^{\lambda \theta} \Delta(\lambda)^{-1} c = \lambda \int_0^{+\infty} e^{-\lambda s} \left(\tilde{U}(s)(X_0 c) \right) (\theta) ds = \lambda \int_{-\theta}^{+\infty} e^{-\lambda s} Z(s + \theta) c ds.$$

So,

$$\Delta(\lambda)^{-1} c = \lambda \int_0^{+\infty} e^{-\lambda t} Z(t) c dt \quad \blacksquare$$

It is easy to prove the following result.

Corollary 21 If $c \in \overline{D(A_0)}$ then the function

$$t \rightarrow Z(t)c$$

is differentiable for all $t > 0$ and we have

$$\Delta(\lambda)^{-1}c = \int_0^{+\infty} e^{-\lambda t} Z'(t)c dt.$$

Hence the name of fundamental integral solution.

The fundamental solution $Z'(t)$ is defined only for $c \in \overline{D(A_0)}$ and is discontinuous at zero. For these reasons we use the fundamental integral solution $Z(t)$ or equivalently $\tilde{U}(\cdot)(X_0)$.

We construct now a variation-of-constants formula for the linear non-homogeneous system

$$u'(t) = A_0 u(t) + L(u_t) + f(t), \quad t \geq 0, \quad (4.8)$$

or its integrated form

$$y(t) = S'(t)\varphi + \frac{d}{dt} \left(\int_0^t \tilde{S}(t-s)X_0L[(y(s)) + f(s)] ds \right), \quad \text{for } t \geq 0, \quad (4.9)$$

where $f : [0, +\infty) \rightarrow X$ is a continuous function.

Theorem 22 For any $\varphi \in \mathcal{C}_X$, such that $\varphi(0) \in \overline{D(A_0)}$, the function $y : [0, +\infty) \rightarrow X$ defined by

$$y(t) = U'(t)\varphi + \frac{d}{dt} \int_0^t \tilde{U}(t-s)X_0f(s) ds, \quad (4.10)$$

satisfies Equation (4.9).

Proof. It follows immediately from Theorem 5 and Corollary 6 that, for $\varphi \in \mathcal{C}_X$ and $\varphi(0) \in \overline{D(A_0)}$, Equation (4.9) has a unique solution y which is the integral solution of the equation

$$\begin{cases} y'(t) = \tilde{A}y(t) + X_0[L(y(t)) + f(t)], & t \geq 0, \\ y(0) = \varphi. \end{cases}$$

On the other hand, $D(\tilde{A}) = D(\tilde{G})$ and $\tilde{G} = \tilde{A} + X_0L$. Then, y is the integral solution of the equation

$$\begin{cases} y'(t) = \tilde{G}y(t) + X_0f(t), & t \geq 0, \\ y(0) = \varphi. \end{cases}$$

Moreover, we have

$$\overline{D(\tilde{G})} = \overline{D(P)} = \left\{ \varphi \in \mathcal{C}_X, \quad \varphi(0) \in \overline{D(A_0)} \right\} = E,$$

and the part of \tilde{G} in \mathcal{C}_X is the operator P . Then $t \rightarrow U(\cdot)\varphi$ is differentiable in $t \geq 0$ and Theorem 4 implies

$$y(t) = U'(t)\varphi + \frac{d}{dt} \int_0^t \tilde{U}(t-s)X_0f(s) ds \quad \blacksquare$$

5. Principle of linearized stability

In this section, we give a result of linearized stability near an equilibrium point of Equation (1.1) in the autonomous case, that is

$$\begin{cases} \frac{du}{dt}(t) = A_0u(t) + F(u_t), & t \geq 0, \\ u_0 = \varphi. \end{cases} \tag{5.1}$$

We make the following hypothesis : F is continuously differentiable, $F(0) = 0$ and F satisfies the Lipschitz condition

$$|F(\varphi_1) - F(\varphi_2)| \leq L \|\varphi_1 - \varphi_2\|, \text{ for all } \varphi_1, \varphi_2 \in \mathcal{C}_X,$$

where L is a positive constant.

Let $T(t) : E \rightarrow E$, for $t \geq 0$, be defined by

$$T(t)(\varphi) = u_t(\cdot, \varphi),$$

where $u(\cdot, \varphi)$ is the unique integral solution of Equation (5.1) and

$$E = \left\{ \varphi \in \mathcal{C}_X, \quad \varphi(0) \in \overline{D(A_0)} \right\}.$$

We know that the family $(T(t))_{t \geq 0}$ is a nonlinear strongly continuous semigroups of continuous operators on E .

Consider the linearized equation of (5.1) corresponding to the Fréchet-derivative $D_\varphi F(0) = F'(0)$ at 0 :

$$\begin{cases} \frac{du}{dt}(t) = A_0u(t) + F'(0)u_t, & t \geq 0, \\ u_0 = \varphi \in \mathcal{C}_X, \end{cases} \tag{5.2}$$

and let $(U'(t))_{t \geq 0}$ be the corresponding linear C_0 -semigroup on E .

Proposition 52 *The Fréchet-derivative at zero of the nonlinear semigroup $T(t)$, $t \geq 0$, associated to Equation (5.1), is the linear semigroup $U'(t)$, $t \geq 0$, associated to Equation (5.2).*

Proof. It suffices to show that, for each $\varepsilon > 0$, there exists $\delta > 0$ such that

$$\|T(t)(\varphi) - U'(t)\varphi\| \leq \varepsilon \|\varphi\|, \text{ for } \|\varphi\| \leq \delta.$$

We have

$$\begin{aligned} \|T(t)(\varphi) - U'(t)\varphi\| &= \sup_{\theta \in [-r, 0]} |(T(t)(\varphi))(\theta) - (U'(t)\varphi)(\theta)|, \\ &= \sup_{\substack{t+\theta \geq 0 \\ \theta \in [-r, 0]}} |(T(t)(\varphi))(\theta) - (U'(t)\varphi)(\theta)|, \end{aligned}$$

and, for $t + \theta \geq 0$

$$(T(t)(\varphi))(\theta) - (U'(t)\varphi)(\theta) = \frac{d}{dt} \int_0^{t+\theta} S_0(t+\theta-s) (F(T(s)(\varphi)) - F'(0)(U'(s)\varphi)) ds.$$

It follows that

$$\|T(t)(\varphi) - U'(t)\varphi\| \leq M_0 e^{\omega_0 t} \int_0^t e^{-\omega_0 s} |F(T(s)(\varphi)) - F'(0)(U'(s)\varphi)| ds$$

and

$$\begin{aligned} \|T(t)(\varphi) - U'(t)\varphi\| &\leq M_0 e^{\omega_0 t} \left(\int_0^t e^{-\omega_0 s} |F(T(s)(\varphi)) - F(U'(s)\varphi)| ds \right. \\ &\quad \left. + \int_0^t e^{-\omega_0 s} |F(U'(s)\varphi) - F'(0)(U'(s)\varphi)| ds \right). \end{aligned}$$

By virtue of the continuous differentiability of F at 0, we deduce that for $\varepsilon > 0$, there exists $\delta > 0$ such that

$$\int_0^t e^{-\omega_0 s} |F(U'(s)\varphi) - F'(0)(U'(s)\varphi)| ds \leq \varepsilon \|\varphi\|, \quad \text{for } \|\varphi\| \leq \delta.$$

On the other hand, we obtain

$$\int_0^t e^{-\omega_0 s} |F(T(s)(\varphi)) - F(U'(s)\varphi)| ds \leq L \int_0^t e^{-\omega_0 s} \|T(s)(\varphi) - U'(s)\varphi\| ds.$$

Consequently,

$$\|T(t)(\varphi) - U'(t)\varphi\| \leq M_0 e^{\omega_0 t} \left(\varepsilon \|\varphi\| + L \int_0^t e^{-\omega_0 s} \|T(s)(\varphi) - U'(s)\varphi\| ds \right).$$

By Gronwall's Lemma, we obtain

$$\|T(t)(\varphi) - U'(t)\varphi\| \leq M_0 \varepsilon \|\varphi\| e^{(LM_0 + \omega_0)t}.$$

We conclude that $T(t)$ is differentiable at 0 and $D_\varphi T(t)(0) = U'(t)$, for each $t \geq 0$ ■

Definition 49 Let Y be a Banach space, $(V(t))_{t \geq 0}$ a strongly continuous semigroup of operators $V(t) : W \subseteq Y \rightarrow W$, $t \geq 0$, and $x_0 \in W$

an equilibrium of $(V(t))_{t \geq 0}$ (i.e., $V(t)x_0 = x_0$, for all $t \geq 0$). The equilibrium x_0 is called exponentially asymptotically stable if there exist $\delta > 0, \mu > 0, k \geq 1$ such that

$$\|V(t)x - x_0\| \leq ke^{-\mu t} \|x - x_0\| \text{ for all } x \in W \text{ with } \|x - x_0\| \leq \delta \text{ and all } t \geq 0.$$

We have the following result.

Theorem 23 *Suppose that the zero equilibrium of $(U'(t))_{t \geq 0}$ is exponentially asymptotically stable, then zero is exponentially asymptotically stable equilibrium of $(T(t))_{t \geq 0}$.*

The proof of this theorem is based on the following result.

Theorem 24 *(Desh and Schappacher [65]) Let $(V(t))_{t \geq 0}$ be a nonlinear strongly continuous semigroup of type γ on a subset W of a Banach space Y , i.e.*

$$\|V(t)x_1 - V(t)x_2\| \leq M'e^{\gamma t} \|x_1 - x_2\|, \text{ for all } x_1, x_2 \in W$$

and assume that $x_0 \in W$ is an equilibrium of $(V(t))_{t \geq 0}$ such that $V(t)$ is Fréchet-differentiable at x_0 for each $t \geq 0$, with $\bar{Y}(t)$ the Fréchet-derivative at x_0 of $V(t)$, $t \geq 0$. Then, $(Y(t))_{t \geq 0}$ is a strongly continuous semigroup of bounded linear operators on Y . If the zero equilibrium of $(Y(t))_{t \geq 0}$ is exponentially asymptotically stable, then x_0 is an exponentially asymptotically stable equilibrium of $(V(t))_{t \geq 0}$.

6. Spectral Decomposition

In this part, we show in the linear autonomous case (Equation (4.4)), the existence of a direct sum decomposition of the state space

$$E = \left\{ \varphi \in \mathcal{C}_X, \quad \varphi(0) \in \overline{D(A_0)} \right\}$$

into three subspaces : stable, unstable and center, which are semigroup invariants. We assume that the semigroup $(T_0(t))_{t \geq 0}$ on $D(A_0)$ is compact. It follows from the compactness property of the semigroup $U'(t)$, for $t > r$, on E , the following results.

Corollary 25 [89] *For each $t > r$, the spectrum $\sigma(U'(t))$ is a countable set and is compact with the only possible accumulation point 0 and if $\mu \neq 0 \in \sigma(U'(t))$ then $\mu \in P\sigma(U'(t))$, (where $P\sigma(U'(t))$ denotes the point spectrum).*

Corollary 26 [89] *There exists a real number δ such that $\Re\lambda \leq \delta$ for all $\lambda \in \sigma(\mathcal{B})$. Moreover, if β is a given real number then there exists only a finite number of $\lambda \in P\sigma(\mathcal{B})$ such that $\Re\lambda > \beta$.*

We can give now an exponential estimate for the semigroup solution.

Proposition 53 *Assume that δ is a real number such that $\Re\lambda \leq \delta$ for all characteristic values of Equation (4.4). Then, for $\gamma > 0$ there exists a constant $k(\gamma) \geq 1$ such that*

$$\|U'(t)\varphi\| \leq k(\gamma)e^{(\delta+\gamma)t} \|\varphi\|, \quad \text{for all } t \geq 0, \varphi \in E.$$

Proof. Let ω_1 be defined by

$$\omega_1 := \inf \left\{ \omega \in \mathbb{R} : \sup_{t \geq 0} (e^{-\omega t} \|U'(t)\|) < +\infty \right\}.$$

The compactness property of the semigroup (see [84]) implies that

$$\omega_1 = s_1(\mathcal{B}) := \sup \{ \Re\lambda : \lambda \in P\sigma(\mathcal{B}) \}.$$

On the other hand, if $\lambda \in P\sigma(\mathcal{B})$ then there exists $\varphi \neq 0 \in D(\mathcal{B})$ such that $\mathcal{B}\varphi = \lambda\varphi$. This implies that

$$\varphi(\theta) = e^{\lambda t}\varphi(0) \quad \text{and} \quad \varphi'(0) = A_0\varphi(0) - L(\varphi) \quad \text{with} \quad \varphi(0) \neq 0.$$

Then, $\Delta(\lambda)\varphi(0) = 0$. We deduce that λ is a characteristic value of Equation (4.4).

We will prove now the existence of $\lambda \in P\sigma(\mathcal{B})$ such that $\Re\lambda = s_1(\mathcal{B})$. Let $(\lambda_n)_n$ be a sequence in $P\sigma(\mathcal{B})$ such that $\Re\lambda_n \rightarrow s_1(\mathcal{B})$ as $n \rightarrow +\infty$. Then, there exists β such that $\Re\lambda_n > \beta$ for $n \geq n_0$ with n_0 large enough. From Corollary 26, we deduce that $\{\lambda_n : \Re\lambda_n > \beta\}$ is finite. So, the sequence $(\Re\lambda_n)_n$ is stationary. Consequently, there exists n such that $\Re\lambda_n = s_1(\mathcal{B})$. This completes the proof of Proposition 53 ■

The asymptotic behavior of solutions can be now completely obtained by the characteristic equation.

Theorem 27 *Let δ be the smallest real number such that if λ is a characteristic value of Equation (4.4), then $\Re\lambda \leq \delta$. If $\delta < 0$, then for all $\varphi \in E$, $\|U'(t)\varphi\| \rightarrow 0$ as $t \rightarrow +\infty$. If $\delta = 0$ then there exists $\varphi \in E \setminus \{0\}$ such that $\|U'(t)\varphi\| = \|\varphi\|$ for all $t \geq 0$. If $\delta > 0$, then there exists $\varphi \in E$ such that $\|U'(t)\varphi\| \rightarrow +\infty$ as $t \rightarrow +\infty$.*

Proof. Assume that $\delta < 0$, then we have $\omega_1 = s_1(\mathcal{B}) < 0$ and the stability holds. If $\delta = 0$, then there exists $x \neq 0$ and a complex λ such

that $\Re\lambda = 0$ and $\Delta(\lambda)x = 0$. Then, $\lambda \in P\sigma(\mathcal{B})$ and $e^{\lambda t} \in P\sigma(U'(t))$. Consequently, there exists $\varphi \neq 0$ such that

$$U'(t)\varphi = e^{\lambda t}\varphi.$$

This implies that $\|U'(t)\varphi\| = \|e^{\lambda t}\varphi\| = \|\varphi\|$. Assume now that $\delta > 0$. Then, there exists $x \neq 0$ and a complex λ such that $\Re\lambda = \delta$ and $\Delta(\lambda)x = 0$. Then, there exists $\varphi \neq 0$ such that $\|U'(t)\varphi\| = e^{\delta t}\|\varphi\| \rightarrow +\infty$, as $t \rightarrow +\infty$. This completes the proof of Theorem 27 ■

Using the same argument as in [96], [section 3.3, Theorem 3.1], we obtain the following result.

Theorem 28 *Suppose that X is complex. Then, there exist three linear subspaces of E denoted by S , US and CN , respectively, such that*

$$E = S \oplus US \oplus CN$$

and

- (i) $\mathcal{B}(S) \subset S$, $\mathcal{B}(US) \subset US$ and $\mathcal{B}(CN) \subset CN$;
- (ii) US and CN are finite dimensional;
- (iii) $P\sigma(\mathcal{B}|_{US}) = \{\lambda \in P\sigma(\mathcal{B}) : \Re\lambda > 0\}$, $P\sigma(\mathcal{B}|_{CN}) = \{\lambda \in P\sigma(\mathcal{B}) : \Re\lambda = 0\}$;
- (iv) $U'(t)(US) \subset US$, $U'(t)(CN) \subset CN$, for $t \in \mathbb{R}$, $U'(t)(S) \subset S$, for $t \geq 0$;
- (v) for any $0 < \gamma < \alpha := \inf\{|\Re\lambda| : \lambda \in P\sigma(\mathcal{B}) \text{ and } \Re\lambda \neq 0\}$, there exists $M = M(\gamma) > 0$ such that

$$\begin{aligned} \|U'(t)P_{US}\varphi\| &\leq Me^{\gamma t}\|P_{US}\varphi\|, & t \leq 0, \\ \|U'(t)P_{CN}\varphi\| &\leq Me^{\frac{\gamma}{3}t}\|P_{CN}\varphi\|, & t \in \mathbb{R}, \\ \|U'(t)P_S\varphi\| &\leq Me^{-\gamma t}\|P_S\varphi\|, & t \geq 0, \end{aligned}$$

where P_S, P_{US} and P_{CN} are projections of E into S, US and CN respectively. S, US and CN are called stable, unstable and center subspaces of the semigroup $(U'(t))_{t \geq 0}$.

7. Existence of bounded solutions

We reconsider now the equation (4.8) mentioned in the introduction. For the convenience of the reader, we restate this equation

$$\begin{cases} \frac{du}{dt}(t) = A_0u(t) + L(u_t) + f(t), & t \geq 0, \\ u_0 = \varphi \in \mathcal{C}_X, \end{cases}$$

and its integrated form

$$u_t = U'(t)\varphi + \frac{d}{dt} \int_0^t \tilde{U}(t-s)X_0f(s)ds, \quad \text{for } t \geq 0. \quad (7.1)$$

where f is a continuous function from \mathbb{R} into X .

Thanks to Lemma 2, we will use the following integrated form of Equation (4.8), which is equivalent to (7.1) :

$$u_t = U'(t)\varphi + \lim_{\lambda \rightarrow +\infty} \int_0^t U'(t-s)\widetilde{B}_\lambda X_0 f(s) ds, \quad \text{for } t \geq 0, \quad (7.2)$$

where the operator $\widetilde{B}_\lambda : \langle X_0 \rangle \rightarrow C_X$ is defined by

$$\widetilde{B}_\lambda X_0 c = \lambda \left(\lambda I - \widetilde{G} \right)^{-1} (X_0 c) = \lambda e^{\lambda \cdot} \Delta(\lambda)^{-1} c, \quad c \in X.$$

We need the following definition.

Definition 50 *We say that the semigroup $(U'(t))_{t \geq 0}$ is hyperbolic if*

$$\sigma(\mathcal{B}) \cap i\mathbb{R} = \emptyset.$$

Theorem 28 implies that, in the hyperbolic case the center subspace CN is reduced to zero. Thus, we have the following result.

Corollary 29 *If the semigroup $(U'(t))_{t \geq 0}$ is hyperbolic, then the space E is decomposed as*

$$E = S \oplus US$$

and there exist positive constants \overline{M} and γ such that

$$\begin{aligned} \|U'(t)\varphi\| &\leq \overline{M}e^{-\gamma t} \|\varphi\|, & t \geq 0, \varphi \in S, \\ \|U'(t)\varphi\| &\leq \overline{M}e^{\gamma t} \|\varphi\|, & t \leq 0, \varphi \in US. \end{aligned}$$

We give now the first main result of this section.

Theorem 30 *Assume that the semigroup $(U'(t))_{t \geq 0}$ is hyperbolic. Let B represent $B(\mathbb{R}^-)$, $B(\mathbb{R}^+)$ or $B(\mathbb{R})$, the set of bounded continuous functions from \mathbb{R}^- , \mathbb{R}^+ or \mathbb{R} respectively to X . Let $\pi : B \rightarrow B$ be a projection onto the integral solutions of Equation (4.4) (for any $\varphi \in E$) which are in B . Then, for any $f \in B$, there is a unique solution $\mathcal{K}f \in B$ of Equation (7.2) (for some $\varphi \in E$) such that $\pi\mathcal{K}f = 0$ and $\mathcal{K} : B \rightarrow B$ is a continuous linear operator. Moreover,*

(i) *for $B = B(\mathbb{R}^-)$, we have*

$$\pi(B) = \left\{ x : \mathbb{R}^- \rightarrow X, \text{ there exists } \varphi \in US \text{ such that } x(t) = (U'(t)\varphi)(0), \quad t \leq 0 \right\}$$

and

$$\begin{aligned} (\mathcal{K}f)_t &= \lim_{s \rightarrow -\infty} \lim_{\lambda \rightarrow +\infty} \int_s^t U'(t-\tau) \left(\widetilde{B}_\lambda X_0 f(\tau) \right)^S d\tau + \\ &\quad \lim_{\lambda \rightarrow +\infty} \int_0^t U'(t-\tau) \left(\widetilde{B}_\lambda X_0 f(\tau) \right)^{US} d\tau. \end{aligned}$$

(ii) For $B = B(\mathbb{R}^+)$, we have

$$\pi(B) = \left\{ x : \mathbb{R}^+ \rightarrow X, \text{ there exists } \varphi \in S \right. \\ \left. \text{such that } x(t) = (U'(t)\varphi)(0), \quad t \geq 0 \right\}$$

and

$$(\mathcal{K}f)_t = \lim_{\lambda \rightarrow +\infty} \int_0^t U'(t-\tau) \left(\widetilde{B}_\lambda X_0 f(\tau) \right)^S d\tau + \\ \lim_{s \rightarrow +\infty} \lim_{\lambda \rightarrow +\infty} \int_s^t U'(t-\tau) \left(\widetilde{B}_\lambda X_0 f(\tau) \right)^{US} d\tau.$$

(iii) For $B = B(\mathbb{R})$, we have

$$\pi(B) = \{0\}$$

and

$$(\mathcal{K}f)_t = \lim_{s \rightarrow -\infty} \lim_{\lambda \rightarrow +\infty} \int_s^t U'(t-\tau) \left(\widetilde{B}_\lambda X_0 f(\tau) \right)^S d\tau + \\ \lim_{s \rightarrow +\infty} \lim_{\lambda \rightarrow +\infty} \int_s^t U'(t-\tau) \left(\widetilde{B}_\lambda X_0 f(\tau) \right)^{US} d\tau.$$

Proof. Theorem 28 implies that the space US is finite dimensional and $U'(t)(US) \subseteq US$. Then,

$\{x : \mathbb{R}^- \rightarrow X, \text{ there exists } \varphi \in US \text{ such that } x(t) = (U'(t)\varphi)(0), \quad t \leq 0\} \subseteq \pi(B(\mathbb{R}^-))$. Conversely, let $\varphi \in S$ and $u(\cdot, \varphi)$ be the integral solution of Equation (4.4) in S , which is bounded on \mathbb{R}^- . Assume that there is a $t \in (-\infty, 0]$ such that $u_t(\cdot, \varphi) \neq 0$. Then, for any $s \in (-\infty, t)$, we have

$$u_t(\cdot, \varphi) = U'(t-s)u_s(\cdot, \varphi).$$

Thanks to Corollary 29 we have

$$\|u_t(\cdot, \varphi)\| \leq \overline{M}e^{-\gamma(t-s)} \|u_s(\cdot, \varphi)\|, \quad s \leq t.$$

Since $u_s(\cdot, \varphi)$ is bounded, we deduce that $u_s(\cdot, \varphi) = 0$. Therefore,

$$\pi(B(\mathbb{R}^-)) \subseteq \left\{ x : \mathbb{R}^- \rightarrow X, \text{ there exists } \varphi \in US \right. \\ \left. \text{such that } x(t) = (U'(t)\varphi)(0), \quad t \leq 0 \right\}.$$

In the same manner, one can prove the same relations for $B(\mathbb{R}^+)$ and $B(\mathbb{R})$.

Let $f \in B(\mathbb{R}^-)$ and $u = u(\cdot, \varphi, f)$ be a solution of Equation (7.2) in $B(\mathbb{R}^-)$, with initial value $\varphi \in E$. Then, the function u can be decomposed as

$$u_t = u_t^{US} + u_t^S,$$

where $u_t^{US} \in US$ and $u_t^S \in S$ are given by

$$u_t^{US} = U'(t-s)u_s^{US} + \lim_{\lambda \rightarrow +\infty} \int_s^t U'(t-\tau) \left(\widetilde{B}_\lambda X_0 f(\tau) \right)^{US} d\tau, \quad \text{for } t, s \in \mathbb{R}, \tag{7.3}$$

$$u_t^S = U'(t-s)u_s^S + \lim_{\lambda \rightarrow +\infty} \int_s^t U'(t-\tau) \left(\widetilde{B}_\lambda X_0 f(\tau) \right)^S d\tau, \quad \text{for } s \leq t \leq 0, \tag{7.4}$$

since $U'(t)$ is defined on US for all $t \in \mathbb{R}$. By Corollary 29, we deduce that

$$u_t^S = \lim_{s \rightarrow -\infty} \lim_{\lambda \rightarrow +\infty} \int_s^t U'(t-\tau) \left(\widetilde{B}_\lambda X_0 f(\tau) \right)^S d\tau, \quad \text{for } t \leq 0. \tag{7.5}$$

By Lemma 1, we get $\widetilde{B}_\lambda X_0 = \lambda e^\lambda \Delta^{-1}(\lambda)$. Thus,

$$\left\| U'(t-\tau) \left(\widetilde{B}_\lambda X_0 f(\tau) \right)^S \right\| \leq \overline{M} e^{-\gamma(t-\tau)} \frac{M\lambda}{\lambda - \omega_1} \sup_{\tau \in (-\infty, 0]} \|f(\tau)\|.$$

Consequently, we get

$$\|u_t^S\| \leq \frac{M\overline{M}}{\gamma} \sup_{\tau \in (-\infty, 0]} \|f(\tau)\|, \quad t \leq 0. \tag{7.6}$$

We have proved that

$$\begin{aligned} u_t &= U'(t)\varphi^{US} + \lim_{\lambda \rightarrow +\infty} \int_0^t U'(t-\tau) \left(\widetilde{B}_\lambda X_0 f(\tau) \right)^{US} d\tau + \\ &\quad \lim_{s \rightarrow -\infty} \lim_{\lambda \rightarrow +\infty} \int_s^t U'(t-\tau) \left(\widetilde{B}_\lambda X_0 f(\tau) \right)^S d\tau, \quad \text{for } t \leq 0. \end{aligned} \tag{7.7}$$

We obtain also, for $t \leq 0$, the following estimate

$$\left\| U'(t)\varphi^{US} + \lim_{\lambda \rightarrow +\infty} \int_0^t U'(t-\tau) \left(\widetilde{B}_\lambda X_0 f(\tau) \right)^{US} d\tau \right\| \leq \frac{\overline{M} e^{\gamma t} \|\varphi^{US}\| + \frac{M\overline{M}}{\gamma} \sup_{\tau \in (-\infty, 0]} \|f(\tau)\|}{\gamma}. \tag{7.8}$$

Conversely, we can verify that the expression (7.7) is a solution of Equation (7.2) in $B(\mathbb{R}^-)$ satisfying the estimates (7.6) and (7.8) for every $\varphi \in E$.

Let $u = u(\cdot, \varphi^{US}, f)$ be defined by (7.7) and let $\mathcal{K} : B(\mathbb{R}^-) \rightarrow B(\mathbb{R}^-)$ be defined by $\mathcal{K}f = (I - \pi)u(\cdot, 0, f)$. We can easily verify that

$$\begin{cases} u_t(\cdot, \varphi^{US}, 0) = U'(t)\varphi^{US}, \\ (I - \pi)u(\cdot, \varphi^{US}, 0) = 0, \\ u(\cdot, \varphi^{US}, f) = u(\cdot, \varphi^{US}, 0) + u(\cdot, 0, f). \end{cases}$$

Therefore, \mathcal{K} is a continuous linear operator on $B(\mathbb{R}^-)$, $\mathcal{K}f$ satisfies Equation (7.2) for every $f \in B(\mathbb{R}^-)$, $\pi\mathcal{K} = 0$ and \mathcal{K} is explicitly given by Theorem 30.

For $B(\mathbb{R}^+)$ and $B(\mathbb{R})$ the proofs are similar. This completes the proof of Theorem 30 ■

We consider now the nonlinear equation

$$\frac{du}{dt}(t) = A_0u(t) + L(u_t) + g(t, u_t), \tag{7.9}$$

and its integrated form

$$u_t = U'(t)\varphi + \lim_{\lambda \rightarrow +\infty} \int_0^t U'(t-s)\widetilde{B}_\lambda X_0g(s, u_s)ds, \tag{7.10}$$

where g is continuous from $\mathbb{R} \times \mathcal{C}_X$ into X . We will assume that **(H1)** $g(t, 0) = 0$ for $t \in \mathbb{R}$ and there exists a nondecreasing function $\alpha : [0, +\infty) \rightarrow [0, +\infty)$ with $\lim_{h \rightarrow 0} \alpha(h) = 0$ and

$$\|g(t, \varphi_1) - g(t, \varphi_2)\| \leq \alpha(h) \|\varphi_1 - \varphi_2\| \quad \text{for } \varphi_1, \varphi_2 \in E, \|\varphi_1\|, \|\varphi_2\| \leq h \text{ and } t \in \mathbb{R}.$$

Proposition 54 *Assume that the semigroup $(U'(t))_{t \geq 0}$ is hyperbolic and the assumption **(H1)** holds. Then, there exists $h > 0$ and $\varepsilon \in]0, h[$ such that for any $\varphi \in S$ with $\|\varphi\| \leq \varepsilon$, Equation (7.10) has a unique bounded solution $u : [-r, +\infty) \rightarrow X$ with $\|u_t\| \leq h$ for $t \geq 0$ and $u_0^S = \varphi$.*

Proof. Let $\varphi \in S$. By Theorem 30, it suffices to establish the existence of a bounded solution $u : [-r, +\infty) \rightarrow X$ of the following equation

$$u_t = U'(t)\varphi + \lim_{\lambda \rightarrow +\infty} \int_0^t U'(t-\tau) \left(\widetilde{B}_\lambda X_0g(\tau, u_\tau) \right)^S d\tau + \lim_{s \rightarrow +\infty} \lim_{\lambda \rightarrow +\infty} \int_s^t U'(t-\tau) \left(\widetilde{B}_\lambda X_0g(\tau, u_\tau) \right)^{US} d\tau.$$

Let $(u^{(n)})_{n \in \mathbb{N}}$ be a sequence of continuous functions from $[-r, +\infty)$ to X , defined by

$$\begin{aligned} u_t^{(0)} &= U'(t)\varphi \\ u_t^{(n+1)} &= U'(t)\varphi + \lim_{\lambda \rightarrow +\infty} \int_0^t U'(t-\tau) \left(\widetilde{B}_\lambda X_0g(\tau, u_\tau^{(n)}) \right)^S d\tau + \lim_{s \rightarrow +\infty} \lim_{\lambda \rightarrow +\infty} \int_s^t U'(t-\tau) \left(\widetilde{B}_\lambda X_0g(\tau, u_\tau^{(n)}) \right)^{US} d\tau. \end{aligned}$$

It is clear that $(u_0^{(n)})^S = \varphi$. Moreover, we can choose $h > 0$ and $\varepsilon \in]0, h[$ small enough such that, if $\|\varphi\| \leq \varepsilon$ then $\|u_t^{(n)}\| < h$ for $t \geq 0$.

On the other hand, we have

$$\begin{aligned} \left\| u_t^{(n+1)} - u_t^{(n)} \right\| &\leq \int_0^t \overline{M} M e^{-\gamma(t-\tau)} \alpha(h) \left\| u_\tau^{(n)} - u_\tau^{(n-1)} \right\| d\tau + \\ &\int_t^{+\infty} \overline{M} M e^{\gamma(t-\tau)} \alpha(h) \left\| u_\tau^{(n)} - u_\tau^{(n-1)} \right\| d\tau. \end{aligned}$$

So, by induction we get

$$\left\| u_t^{(n+1)} - u_t^{(n)} \right\| \leq 2h \left(\frac{2\overline{M}M\alpha(h)}{\gamma} \right)^n, \quad t \geq 0.$$

We choose $h > 0$ such that

$$\frac{2\overline{M}M\alpha(h)}{\gamma} < \frac{1}{2}.$$

Consequently, the limit $u := \lim_{n \rightarrow +\infty} u^{(n)}$ exists uniformly on $[-r, +\infty)$ and u is continuous on $[-r, +\infty)$. Moreover, $\|u_t\| < h$ for $t \geq 0$ and $u_0^S = \varphi$.

In order to prove that u is a solution of Equation (7.10), we introduce the following notation

$$\begin{aligned} v(t) = &\left\| u_t - U'(t)\varphi - \lim_{\lambda \rightarrow +\infty} \int_0^t U'(t-\tau) \left(\widetilde{B}_\lambda X_0 g(\tau, u_\tau) \right)^S d\tau \right. \\ &\left. - \lim_{s \rightarrow +\infty} \lim_{\lambda \rightarrow +\infty} \int_s^t U'(t-\tau) \left(\widetilde{B}_\lambda X_0 g(\tau, u_\tau) \right)^{US} d\tau \right\|. \end{aligned}$$

We obtain

$$\begin{aligned} v(t) \leq &\left\| u_t - u_t^{(n+1)} \right\| \\ &+ \left\| \lim_{\lambda \rightarrow +\infty} \int_0^t U'(t-\tau) \left(\left(\widetilde{B}_\lambda X_0 g(\tau, u_\tau) \right)^S - \left(\widetilde{B}_\lambda X_0 g(\tau, u_\tau^{(n)}) \right)^S \right) d\tau \right\| \\ &+ \left\| \lim_{s \rightarrow +\infty} \lim_{\lambda \rightarrow +\infty} \int_s^t U'(t-\tau) \left(\left(\widetilde{B}_\lambda X_0 g(\tau, u_\tau) \right)^{US} - \left(\widetilde{B}_\lambda X_0 g(\tau, u_\tau^{(n)}) \right)^{US} \right) d\tau \right\|. \end{aligned}$$

Moreover, we have

$$u_t - u_t^{(n+1)} = \sum_{k=n+1}^{+\infty} \left(u_t^{(k+1)} - u_t^{(k)} \right).$$

It follows that

$$v(t) \leq 2h \left[1 + \frac{2\overline{M}M\alpha(h)}{\gamma} \right] \sum_{k=n+1}^{+\infty} \left(\frac{2\overline{M}M\alpha(h)}{\gamma} \right)^k.$$

Consequently, $v = 0$ on $[0, +\infty)$.

To show the uniqueness suppose that w is also a solution of Equation (7.10) with $\|w_t\| < h$ for $t \geq 0$. Then,

$$\begin{aligned} & \left\| w_t - u_t^{(n+1)} \right\| \leq \\ & \left\| \lim_{\lambda \rightarrow +\infty} \int_0^t U'(t-\tau) \left(\left(\widetilde{B}_\lambda X_0 g(\tau, w_\tau) \right)^S - \left(\widetilde{B}_\lambda X_0 g(\tau, u_\tau^{(n)}) \right)^S \right) d\tau \right\| \\ & + \left\| \lim_{s \rightarrow +\infty} \lim_{\lambda \rightarrow +\infty} \int_s^t U'(t-\tau) \left(\left(\widetilde{B}_\lambda X_0 g(\tau, w_\tau) \right)^{US} - \left(\widetilde{B}_\lambda X_0 g(\tau, u_\tau^{(n)}) \right)^{US} \right) d\tau \right\|. \end{aligned}$$

This implies

$$\left\| w_t - u_t^{(n+1)} \right\| \leq 2h \left(\frac{2\overline{M}M\alpha(h)}{\gamma} \right)^n \rightarrow 0, \quad \text{as } n \rightarrow +\infty.$$

This proves the uniqueness and completes the proof ■

8. Existence of periodic or almost periodic solutions

In this section, we are concerned with the existence of periodic (or almost periodic) solutions of Equations (7.2) and (7.10).

As a consequence of the existence of a bounded solution we obtain the following result.

Corollary 31 *Assume that the semigroup $(U'(t))_{t \geq 0}$ is hyperbolic. If the function f is ω -periodic, then the bounded solution of Equation (7.2) given by Theorem 30 is also ω -periodic.*

Proof. Let u be the unique bounded solution of Equation (7.2). The function $u(\cdot + \omega)$ is also a bounded solution of Equation (7.2). The uniqueness property implies that $u = u(\cdot + \omega)$. This completes the proof of the corollary ■

We are concerned now with the existence of almost periodic solution of Equation (7.2). We first recall a definition.

Definition 51 *A function $g \in B(\mathbb{R})$ is said to be almost periodic if and only if the set*

$$\{g_\sigma : \sigma \in \mathbb{R}\},$$

where g_σ is defined by $g_\sigma(t) = g(t + \sigma)$, for $t \in \mathbb{R}$, is relatively compact in $B(\mathbb{R})$.

Theorem 32 *Assume that the semigroup $(U'(t))_{t \geq 0}$ is hyperbolic. If the function f is almost periodic, then the bounded solution of Equation (7.2) is also almost periodic.*

Proof. Let $AP(\mathbb{R})$ be the Banach space of almost periodic functions from \mathbb{R} to X endowed with the uniform norm topology. Define the operator Q by

$$(Qf)(t) = \lim_{s \rightarrow -\infty} \lim_{\lambda \rightarrow +\infty} \int_s^t U'(t - \tau) \left(\widetilde{B}_\lambda X_0 f(\tau) \right)^S (0) d\tau + \lim_{s \rightarrow +\infty} \lim_{\lambda \rightarrow +\infty} \int_s^t U'(t - \tau) \left(\widetilde{B}_\lambda X_0 f(\tau) \right)^{US} (0) d\tau, \quad \text{for } t \in \mathbb{R}.$$

Then, Q is a bounded linear operator from $AP(\mathbb{R})$ into $B(\mathbb{R})$. By a sample computation, we obtain

$$(Qf)_\sigma = Q(f_\sigma), \quad \text{for } \sigma \in \mathbb{R}.$$

By the continuity of the operator Q , we deduce that $Q(\{f_\sigma : \sigma \in \mathbb{R}\})$ is relatively compact in $B(\mathbb{R})$. This implies that if the function f is almost periodic, then the bounded solution of Equation (7.2) is also almost periodic. This completes the proof of the theorem.

We are concerned now with the existence of almost periodic solutions of Equation (7.10). We will assume the followings.

(H2) g is almost periodic in t uniformly in any compact set of \mathcal{C}_X . This means that for each $\varepsilon > 0$ and any compact set K of \mathcal{C}_X there exists $l_\varepsilon > 0$ such that every interval of length l_ε contains a number τ with the property that

$$\sup_{t \in \mathbb{R}, \varphi \in K} \|g(t + \tau, \varphi) - g(t, \varphi)\| < \varepsilon.$$

We know from [63] that if the function g is almost periodic in t uniformly in any compact set of \mathcal{C}_X and if v is an almost periodic function, then the function $t \mapsto g(t, v_t)$ is also almost periodic.

(H3) $\|g(t, \varphi_1) - g(t, \varphi_2)\| \leq K_1 \|\varphi_1 - \varphi_2\|, \quad t \in \mathbb{R}, \varphi_1, \varphi_2 \in \mathcal{C}_X.$

We have the following result.

Proposition 55 *Assume that the semigroup $(U'(t))_{t \geq 0}$ is hyperbolic and **(H2)**, **(H3)** hold. Then, if in the assumption **(H3)** K_1 is chosen small enough, Equation (7.10) has a unique almost periodic solution.*

Proof. Consider the operator H defined on $AP(\mathbb{R})$ by

$$Hv = u,$$

where u is the unique almost periodic solution of Equation (7.2) with $f = g(\cdot, v)$. We can see that there exists a positive constant K_2 such that

$$\|Hv_1 - Hv_2\| \leq K_1 K_2 \|v_1 - v_2\|, \quad v_1, v_2 \in AP(\mathbb{R}).$$

If K_1 is chosen such that $K_1K_2 < 1$, then the map H is a strict contraction in $AP(\mathbb{R})$. So, H has a unique fixed point in $AP(\mathbb{R})$. This gives an almost periodic solution of Equation (7.10). This completes the proof of the proposition ■

9. Applications

We now consider the two examples mentioned in the introduction. For the convenience of the reader, we restate the equations.

Example 1

$$\begin{cases} \frac{\partial u}{\partial t}(t, a) + \frac{\partial u}{\partial a}(t, a) = f(t, a, u_t(\cdot, a)), & t \in [0, T], a \in [0, l], \\ u(t, 0) = 0, & t \in [0, T], \\ u(\theta, a) = \varphi(\theta, a), & \theta \in [-r, 0], a \in [0, l]. \end{cases} \tag{9.1}$$

where $T, l > 0$, $\varphi \in \mathcal{C}_X := \mathcal{C}([-r, 0], X)$ and $X = \mathcal{C}([0, l], \mathbb{R})$.

By setting $U(t) = u(t, \cdot)$, Equation (9.1) reads

$$\begin{cases} V'(t) = A_0V(t) + F(t, V_t), & t \in [0, T], \\ V(0) = \varphi, \end{cases}$$

where $A_0 : D(A_0) \subseteq X \rightarrow X$ is the linear operator defined by

$$\begin{cases} D(A_0) = \{u \in \mathcal{C}^1([0, l], \mathbb{R}); u(0) = 0\}, \\ A_0u = -u', \end{cases}$$

and $F : [0, T] \times \mathcal{C}_X \rightarrow X$ is the function defined by

$$F(t, \varphi)(a) = f(t, a, \varphi(\cdot, a)), \text{ for } t \in [0, T], \varphi \in \mathcal{C}_X \text{ and } a \in [0, l].$$

We have $\overline{D(A_0)} = \{u \in \mathcal{C}([0, l], \mathbb{R}); u(0) = 0\} \neq X$. Moreover,

$$\begin{cases} \rho(A_0) = \mathbf{C}, \\ \left\| (\lambda I - A_0)^{-1} \right\| \leq \frac{1}{\lambda}, \text{ for } \lambda > 0, \end{cases}$$

this implies that A_0 satisfies **(HY)** on X (with $M_0 = 1$ and $\omega_0 = 0$).

We have the following result.

Theorem 33 *Assume that F is continuous on $[0, T] \times \mathcal{C}_X$ and satisfies a Lipschitz condition*

$$|F(t, \varphi) - F(t, \psi)| \leq L \|\varphi - \psi\|, \text{ } t \in [0, T] \text{ and } \varphi, \psi \in \mathcal{C}_X,$$

with $L \geq 0$ constant. Then, for a given $\varphi \in \mathcal{C}_X$, such that

$$\varphi(0, 0) = 0,$$

there exists a unique function $u : [0, T] \rightarrow X$ solution of the following initial value problem

$$u(t, a) = \begin{cases} \int_0^a f(\tau - a + t, \tau, u_{\tau - a + t}(\cdot, \tau)) d\tau, & \text{if } a \leq t, \\ \varphi(0, a - t) + \int_{a-t}^a f(\tau - a + t, \tau, u_{\tau - a + t}(\cdot, \tau)) d\tau, & \text{if } a \geq t \geq 0, \\ \varphi(t, a), & \text{if } t \leq 0. \end{cases} \tag{9.2}$$

Furthermore, u is the unique integral solution of the partial differential equation (9.1), i.e.

- (i) $u \in \mathcal{C}_X$, $\int_0^t u(s, \cdot) ds \in \mathcal{C}^1([0, l], \mathbb{R})$ and $\int_0^t u(s, 0) ds = 0$, for $t \in [0, T]$,
- (ii)

$$u(t, a) = \begin{cases} \varphi(0, a) + \frac{\partial}{\partial a} \int_0^t u(s, a) ds + \int_0^t f(s, a, u_t(\cdot, a)) ds, & \text{if } t \in [0, T], \\ \varphi(t, a), & \text{if } t \in [-r, 0]. \end{cases}$$

Proof. The assumptions of Theorem 33 imply that $\varphi \in \mathcal{C}_X$ and $\varphi(0, \cdot) \in \overline{D(A_0)}$. Consequently, from Theorem 5, we deduce that there exists a unique function $v : [0, T] \rightarrow \mathcal{C}_X$ which solves the integral equation (3.1). It suffices to calculate each term of the integral equation (3.1).

Let $(S_0(t))_{t \geq 0}$ be the integrated semigroup on X generated by A_0 . In view of the definition of $(S_0(t))_{t \geq 0}$, we have

$$\left((\lambda I - A_0)^{-1} x \right) (a) = \lambda \int_0^{+\infty} e^{-\lambda t} (S_0(t)x)(a) dt.$$

On the other hand, solving the equation

$$(\lambda I - A_0)y = x, \quad \text{where } \lambda > 0, y \in D(A_0) \text{ and } x \in X,$$

we obtain

$$\left((\lambda I - A_0)^{-1} x \right) (a) = y(a) = \int_0^a e^{-\lambda t} x(a - t) dt.$$

Integrating by parts one obtains

$$\left((\lambda I - A_0)^{-1} x \right) (a) = e^{-\lambda a} \int_0^a x(t) dt + \int_0^a e^{-\lambda t} \left(\int_{a-t}^a x(s) ds \right) dt.$$

By uniqueness of Laplace transform, we obtain

$$(S_0(t)x)(a) = \begin{cases} \int_0^a x(s) ds, & \text{if } a \leq t, \\ \int_{a-t}^a x(s) ds, & \text{if } a \geq t. \end{cases}$$

Using Proposition 48, we obtain

$$(S(t)\varphi)(\theta, a) = \begin{cases} \int_{\theta}^0 \varphi(s, a) ds + \int_0^a \varphi(0, \tau) d\tau, & \text{if } a \leq t + \theta, \\ \int_{\theta}^0 \varphi(s, a) ds + \int_{a-t-\theta}^a \varphi(0, \tau) d\tau, & \text{if } a \geq t + \theta \geq 0, \\ \int_{\theta}^{t+\theta} \varphi(s, a) ds, & \text{if } t + \theta \leq 0. \end{cases}$$

The assumption $\varphi(0, 0) = 0$ implies that $S(\cdot)\varphi \in \mathcal{C}^1([0, T], \mathcal{C}_X)$ and we have

$$\frac{d}{dt}(S(t)\varphi)(\theta, a) = \begin{cases} 0, & \text{if } a \leq t + \theta, \\ \varphi(0, a - t - \theta), & \text{if } a \geq t + \theta \geq 0, \\ \varphi(t + \theta, a), & \text{if } t + \theta \leq 0. \end{cases}$$

Remark that the condition $\varphi(0, 0) = 0$ is necessary to have $S(\cdot)\varphi \in \mathcal{C}^1([0, T], \mathcal{C}_X)$.

Let $G : [0, T] \rightarrow X$ ($T > 0$) be a Bochner-integrable function and consider the function $K : [0, T] \rightarrow \tilde{\mathcal{C}}_X$ defined by

$$K(t) = \int_0^t \tilde{S}_0(t - s)X_0G(s) ds.$$

For $a \leq t + \theta$, we have

$$\begin{aligned} K(t)(\theta, a) &= \int_0^{t+\theta} (S_0(t + \theta - s)G(s))(a) ds, \\ &= \int_0^{t+\theta-a} \left(\int_0^a G(s)(\tau) d\tau\right) ds + \int_{t+\theta-a}^{t+\theta} \left(\int_{a-t-\theta+s}^a G(s)(\tau) d\tau\right) ds. \end{aligned}$$

For $a \geq t + \theta \geq 0$, we obtain

$$K(t)(\theta, a) = \int_0^{t+\theta} \left(\int_{a-t-\theta+s}^a G(s)(\tau) d\tau\right) ds,$$

and for $t + \theta \leq 0$, we have $K(t)(\theta, a) = 0$.

The derivation of K is easily obtained

$$\frac{dK}{dt}(t)(\theta, a) = \begin{cases} \int_0^a G(\tau - a + t + \theta)(\tau) d\tau, & a \leq t + \theta, \\ \int_{a-t-\theta}^a G(\tau - a + t + \theta)(\tau) d\tau, & a \geq t + \theta \geq 0, \\ 0, & t + \theta \leq 0. \end{cases}$$

If we consider the function $u : [-r, T] \rightarrow X$ defined by

$$u(t, \cdot) = \begin{cases} v(t)(0, \cdot), & \text{if } t \geq 0, \\ \varphi(t, \cdot), & \text{if } t \leq 0. \end{cases}$$

Corollary 7 implies that $u_t = v(t)$. Hence, u is the unique solution of (9.2).

The second part of Theorem 33 follows from Corollary 7 ■

Theorem 34 *Assume that F is continuously differentiable and there exist constants $L, \beta, \gamma \geq 0$ such that*

$$\begin{aligned} |F(t, \varphi) - F(t, \psi)| &\leq L \|\varphi - \psi\|, \\ |D_t F(t, \varphi) - D_t F(t, \psi)| &\leq \beta \|\varphi - \psi\|, \\ |D_\varphi F(t, \varphi) - D_\varphi F(t, \psi)| &\leq \gamma \|\varphi - \psi\|. \end{aligned}$$

Then, for given $\varphi \in \mathcal{C}_X$ such that

$$\begin{aligned} \frac{\partial \varphi}{\partial t} &\in \mathcal{C}_X, \quad \varphi(0, \cdot) \in \mathcal{C}^1([0, l], \mathbb{R}), \\ \varphi(0, 0) &= \frac{\partial \varphi}{\partial t}(0, 0) = 0 \quad \text{and} \\ \frac{\partial \varphi}{\partial t}(0, a) + \frac{\partial \varphi}{\partial a}(0, a) &= f(0, a, \varphi(\cdot, a)), \quad \text{for } a \in [0, l], \end{aligned}$$

the solution u of Equation (9.2) is continuously differentiable on $[0, T] \times [0, l]$ and is equal to the unique solution of Problem (9.1).

Proof. One can use Theorem 10 (all the assumptions of this theorem are satisfied).

Example 2

$$\begin{cases} \frac{\partial u}{\partial t}(t, x) = \Delta u(t, x) + f(t, x, u_t(\cdot, x)), & t \in [0, T], \quad x \in \Omega, \\ u(t, x) = 0, & t \in [0, T], \quad x \in \partial\Omega, \\ u(\theta, x) = \varphi(\theta, x), & \theta \in [-r, 0], \quad x \in \Omega, \end{cases} \tag{9.3}$$

where $\Omega \subset \mathbb{R}^n$ is a bounded open set with regular boundary $\partial\Omega$, Δ is the Laplace operator in the sense of distributions on Ω and φ is a given function on $\mathcal{C}_X := C([-r, 0], X)$, with $X = \mathcal{C}(\bar{\Omega}, \mathbb{R})$.

Problem (9.3) can be reformulated as an abstract semilinear functional differential equation

$$\begin{cases} V'(t) = A_0 V(t) + F(t, V_t), & t \in [0, T], \\ V(0) = \varphi, \end{cases}$$

with

$$\begin{aligned} D(A_0) &= \{u \in \mathcal{C}(\bar{\Omega}, \mathbb{R}); \Delta u \in \mathcal{C}(\bar{\Omega}, \mathbb{R}) \text{ and } u = 0 \text{ on } \partial\Omega\}, \\ A_0 u &= \Delta u, \end{aligned}$$

and $F : [0, T] \times \mathcal{C}_X \rightarrow X$ is defined by

$$F(t, \varphi)(x) = f(t, x, \varphi(\cdot, x)) \quad \text{for } t \in [0, T], \quad \varphi \in \mathcal{C}_X \text{ and } x \in \Omega.$$

We have $\overline{D(A_0)} = \{u \in C(\overline{\Omega}, \mathbb{R}) ; u = 0 \text{ on } \partial\Omega\} \neq X$.
 Moreover

$$\begin{cases} \rho(A_0) \subset (0, +\infty) \\ \left\| (\lambda I - A_0)^{-1} \right\| \leq \frac{1}{\lambda}, \quad \text{for } \lambda > 0, \end{cases}$$

this implies that A_0 satisfies **(HY)** on X (with $M_0 = 1$ and $\omega_0 = 0$).

Using the results of Section 3, we obtain the following theorems (the all assumptions are satisfied).

Theorem 35 *Assume that F is continuous on $[0, T] \times C_X$ and satisfies a Lipschitz condition*

$$|F(t, \varphi) - F(t, \psi)| \leq L \|\varphi - \psi\|, \quad t \in [0, T] \text{ and } \varphi, \psi \in C_X,$$

with $L \geq 0$ constant. Then, for a given $\varphi \in C_X$, such that

$$\Delta\varphi(0, \cdot) = 0, \text{ on } \partial\Omega,$$

there exists a unique integral solution $u : [0, T] \rightarrow X$ of the partial differential equation (9.3), i.e.

- (i) $u \in C_X, \Delta\left(\int_0^t u(s, \cdot) ds\right) \in C(\overline{\Omega}, \mathbb{R})$ and $\int_0^t u(s, \cdot) ds = 0$, on $\partial\Omega$,
- (ii)

$$u(t, x) = \begin{cases} \varphi(0, x) + \Delta\left(\int_0^t u(s, x) ds\right) + \int_0^t f(s, x, u_t(\cdot, x)) ds, & \text{if } t \in [0, T], \\ & \text{and } x \in \overline{\Omega} \\ \varphi(t, x), & \text{if } t \in [-r, 0], \\ & \text{and } x \in \overline{\Omega}. \end{cases}$$

Theorem 36 *Assume that F is continuously differentiable and there exist constants $L, \beta, \gamma \geq 0$ such that*

$$\begin{aligned} |F(t, \varphi) - F(t, \psi)| &\leq L \|\varphi - \psi\|, \\ |D_t F(t, \varphi) - D_t F(t, \psi)| &\leq \beta \|\varphi - \psi\|, \\ |D_\varphi F(t, \varphi) - D_\varphi F(t, \psi)| &\leq \gamma \|\varphi - \psi\|. \end{aligned}$$

Then, for given $\varphi \in C_X$ such that

$$\begin{aligned} \frac{\partial\varphi}{\partial t} &\in C_X, \quad \Delta\varphi(0, \cdot) \in C(\overline{\Omega}, \mathbb{R}), \\ \varphi(0, \cdot) &= \frac{\partial\varphi}{\partial t}(0, \cdot) = 0 \text{ on } \partial\Omega \text{ and} \\ \frac{\partial\varphi}{\partial t}(0, x) &= \Delta\varphi(0, x) + f(0, x, \varphi(\cdot, x)), \text{ for } x \in \overline{\Omega}. \end{aligned}$$

There is a unique function x defined on $[-r, T] \times \Omega$, such that $x = \varphi$ on $[-r, 0] \times \Omega$ and satisfies Equation (9.3) on $[0, T] \times \Omega$.

References

- [1] O. Arino (1992) Some spectral properties for the asymptotic behavior of semigroups connected to population dynamics. *SIAM Rev.* Vol.34, N.4: 445-476.
- [2] O. Arino and M. Kimmel (1987) Asymptotic analysis of a cell cycle model based on unequal division. *SIAM J. Appl. Math.* Vol. 47, N.1: 128-145.
- [3] O. Arino and M. Kimmel (1989) Asymptotic behavior of a nonlinear functional-integral equation of cell kinetics with unequal division. *J. Math. Biol.* **27**: 341-354.
- [4] O. Arino and M. Kimmel (1991) Asymptotic behaviour of nonlinear semigroup describing a model of selective cell growth regulation. *J. Math. Biol.* **29**: 289-314.
- [5] O. Arino and A. Mortabit (1992) A periodicity result for a nonlinear functional integral equation. *J. Math. Biol.* **30**: 437-456.
- [6] O. Arino and E. Sánchez (1995) Linear Theory of Abstract Functional Differential Equations of Retarded Type. *J. Math. Anal. and Appl.* **191**: 547-571.
- [7] O. Arino and E. Sánchez (1996) A variation of constants formula for an abstract functional differential equation of retarded type. *Diff. and Int. Equat.* Vol.9, N.6: 1305-1320.
- [8] O. Arino and E. Sánchez (1998) An integral equation of cell population dynamics formulated as an abstract delay equation. Some consequences. *Math. Models and Methods in Applied Sci.* Vol.8, N.4: 713-735.
- [9] C. Bernier and A. Manitius (1978) On semigroups in $\mathbf{R}^n \times L^p$ corresponding to differential equations with delay. *Canad. J. Math.* **30**: 897-914.

- [10] F.E. Browder (1961) On the spectral theory of elliptic differential operators. *Math. Ann.* **142**: 22-130.
- [11] A. Calsina and O. El Idrissi (1999) Asymptotic behaviour of an age-structured population model and optimal maturation age. *J. Math. Anal. and Appl.* **223**: 808-826.
- [12] S.N. Chow and J. Mallet-Paret (1977) Integral averaging and bifurcation. *J. Diff. Equat.* **26**: 112-159.
- [13] O. Diekmann, H.J. Heijmans and H.R. Thieme (1984) On the stability of the cell size distribution. *J. Math. Biol.* **19**: 227-248.
- [14] J. Diestel and J.J. Uhl (1977) *Vector Measures*. Am. Math. Soc. Mathematical Surveys N.15.
- [15] N. Dunford and J. Schwartz (1958) *Linear Operators. Part I: General Theory*. Interscience.
- [16] A. Grabosch (1989) Translation semigroups and their linearizations on spaces of integrable functions. *Trans. Amer. Math. Soc.* **311**: 357-390.
- [17] A. Grabosch and H.J. Heijmans (1991) Production, development and maturation of red blood cells: a mathematical model. *Mathematical Population Dynamics*. Lect. Notes in Pure and Applied Mathematics. Vol. 131. Marcel Dekker: 189-210.
- [18] A. Grabosch and U. Moustakas (1986) A semigroup approach to retarded differential equations. *One-Parameter Semigroups of Positive Operators*. R. Nagel Ed. Lect. Notes in Math. 1184 (219-232). Springer-Verlag.
- [19] J. Hale (1977) *Functional Differential Equations*. Springer.
- [20] J. Hale and S.M. Verduin Lunel (1993) *Introduction to Functional Differential Equations*. Springer.
- [21] E. Hille (1948) *Functional analysis and semigroups*. Amer. Math. Soc. Colloq. Pub. XXXI. A.M.S. Providence, RI.
- [22] G.S. Jones (1962) The existence of periodic solutions of $f'(x) = -\alpha f(x-1)\{1 + f(x)\}$. *J. Math. Anal. and Applications*. **5**: 435-450.
- [23] T. Kato (1966) *Perturbation Theory for Linear Operators*. Springer-Verlag.

- [24] M. Kimmel, Z. Darzynkiewicz, O. Arino and F. Traganos (1984) Analysis of a cell cycle model based on unequal division of metabolic constituents to daughter cells during cytokinesis. *J. Theor. Biol.* **110**: 637-664.
- [25] K. Kunish and W. Schappacher (1981) Variation of Constants Formula for Partial Differential Equations with Delay. *Nonlinear Anal. TMA.* **5**: 123-142.
- [26] K. Kunish and W. Schappacher (1983) Necessary conditions for partial differential equations with delay to generate C_0 -semigroups. *J. Diff. Equations.* **50**: 49-79.
- [27] A. Manitius (1980) Completeness and F-completeness of eigenfunctions associated with retarded functional differential equations. *J. Diff. Equations.* **35**: 1-29.
- [28] R. Nagel (Ed.) (1986) *One-Parameter Semigroups of Positive Operators*. Lect. Notes Math. 1184. Springer-Verlag.
- [29] S. Nakagiri (1981) On the Fundamental Solution of Delay-Differential Equations in Banach Spaces. *J. Diff. Equations.* **41**: 349-368.
- [30] S. Nakagiri (1987) Pointwise completeness and degeneracy of functional differential equations in Banach spaces I: General time delays. *J. Math. Anal. Appl.* **127**: 492-529.
- [31] S. Nakagiri (1988) Structural properties of functional differential equations in Banach spaces. *Osaka J. Math.* **25**: 353-398.
- [32] R. Nussbaum (1970) The radius of the essential spectrum. *Duke Math. J.* **37**: 473-478.
- [33] A. Pazy (1983) *Semigroups of linear operators and applications to partial differential equations*. Springer Verlag, N.Y.
- [34] A.T. Plant (1977) Nonlinear semigroups of translations in Banach space generated by functional differential equations. *J. Math. Anal. Appl.* **60**: 67-74.
- [35] W. Rudin (1973) *Functional Analysis*. McGraw-Hill.
- [36] E. Sánchez, O. Arino and M. Kimmel (1991) Noncompact semigroups of operators generated by cell kinetics models. *Differential and Integral Equations*. Vol.4, N.6: 1233-1249.

- [37] H.H. Schaefer (1971) *Topological Vector Spaces*. Springer Verlag.
- [38] K. Shumacher (1985) On the resolvent of linear nonautonomous partial differential equations. *J. Diff. Equations*. **59**: 355-387.
- [39] A. Taylor (1967) *Introduction to Functional Analysis*. John Wiley.
- [40] C.C. Travis and G.F. Webb (1974) Existence and Stability for Partial Functional Differential Equations. *Trans. Amer. Math. Soc.* **200**: 395-418.
- [41] H.O. Walther (1975) Existence of a nonconstant periodic solution of a nonlinear nonautonomous functional differential equation representing the growth of a single species population. *J. Math. Biol.* **1**: 227-240.
- [42] G.F. Webb (1985) *Theory of Nonlinear Age-Dependent Population Dynamics*. Marcel Dekker Inc.
- [43] M.Adimy, Integrated semigroups and delay differential equations, *Journal of .Mathematical Analysis and .Applications*, 177, (1993), 125-134.
- [44] M. Adimy et K. Ezzinbi, Semi-groupes intégrés et équations différentielles à retard en dimension infinie, *C. R. Acad. Sci. Paris, t.323, Série I, (1996), 481-486*.
- [45] M. Adimy et K. Ezzinbi, Local existence and linearized stability for partial functional differential equations, *Dynamic Systems and applications*, 7, (1998), 389-404.
- [46] M Adimy and K. Ezzinbi, A class of linear partial neutral functional differential equations with non-dense domain, *Journal of Differential Equations*, 147, (1998), 285-332.
- [47] M Adimy and K. Ezzinbi, Existence and linearized stability for partial neutral functional differential equations, *Journal of Differential Equations and Dynamical Systems Vol. 7, Number 4, October, (1999), 371-417*.
- [48] M. Adimy and K. Ezzinbi, Some results on existence, asymptotic behavior and stability of solutions for a class of partial neutral functional differential equations, *Hiroshima Mathematical Journal*, (to appear 2004).

- [49] M Adimy, K. Ezzinbi and M. Laklach, Local existence and global continuation for a class of partial neutral functional differential equations, *C.R.Acad. Sci. Paris, t.330, Série I, (2000), 957-962.*
- [50] M Adimy, H.Bouzahir and K. Ezzinbi, Existence for a class of partial functional differential equations with infinite delay, *Journal of Nonlinear Analysis, Theory, Methods and Applications, Vol 46, N° 1, (2001), 91-112.*
- [51] M Adimy, H. Bouzahir and K. Ezzinbi, Local existence and stability for a class of partial functional differential equations with infinite delay, *Journal of Nonlinear Analysis, Theory, Methods and Applications, 48, (2002), 323-348.*
- [52] M. Adimy, H. Bouzahir and K. Ezzinbi, Local existence for a class of partial neutral functional differential equations with infinite delay, *Journal of Differential Equations and Dynamical Systems, (to appear 2004).*
- [53] M. Adimy, H. Bouzahir and K. Ezzinbi, Existence and stability for some partial neutral functional differential equations with infinite delay, *Journal of Mathematical Analysis and Applications, Vol. 294, Issue 2, (2004), 438-461.*
- [54] M. Adimy, K.Ezzinbi and M. Laklach, Spectral decomposition for some neutral partial functional differential equations, *Canadian Applied Mathematics Quarterly, Vol. 9, N° 4, Winter (2001), 1-34.*
- [55] E. Ait Dads and K. Ezzinbi, Boundedness and almost periodicity for some state-dependent delay differential equations, *Electronic Journal of Differential Equations, Vol. 2002, N° 67, <http://ejde.math.swt.edu> , (2002), 1-13.*
- [56] W.Arendt, Resolvent positive operators and integrated semigroup, *Proc. London Math. Soc., 3, vol.54, (1987), 321-349.*
- [57] W.Arendt, Vector valued Laplace transforms and Cauchy problems, *Israel J.Math., 59, (1987), 327-352.*

- [58] O.Arino et E.Sanchez, Linear theory of abstract functional differential equations of retarded type, *Journal of Mathematical Analysis and Applications*, 191, (1995), 547-571.
- [59] R. Benkhalti and K. Ezzinbi, Existence and stability for some partial neutral functional differential equations, *Differential and Integral Equations*, (to appear 2004).
- [60] K. Ezzinbi and R. Benkhalti, Periodic solutions for some partial functional differential equations, *Journal of Applied Mathematics and Stochastic Analysis*, (to appear 2004).
- [61] S.Busenberg and B.Wu, Convergence theorems for integrated semigroup, *Diff. Int. Eq.* 5, vol. 3, May, (1992), 509-520.
- [62] P.Clément, O.Diekmann, M.Gyllenberg, H.J.A.M. Heijmans and H.R.Thieme, Perturbation theory for dual semigroups. I. the sun-reflexive case, *Math. Ann.*, 277, (1987), 709-725.
- [63] C. Corduneanu, Almost Periodic Functions, 2nd edition, *Chelsea*, New York (1989).
- [64] G.Da Prato and E.Sinestrari, Differential operators with non-dense domains, *Ann., Scuola, Norm., Sup. Pisa Cl. Sci.*, 14, (1987), 285-344.
- [65] W. Desch and W. Schappacher, Linearized stability for nonlinear semigroups, in "Differential Equations in Banach Spaces" (A.Favini and E.Obrecht, Eds.) pp. 61-73, *Lecture Notes in Math.*, Vol. 1223, Springer-Verlag, New York / Berlin (1986).
- [66] O. Diekmann, S. A. Van Gils, S. M. Verduyn Lunel and H. O. Walther, Delay Equations, Functional, Complex and Nonlinear Analysis, *Springer-Verlag*, (1995).
- [67] K. Ezzinbi, Existence and stability for some partial functional differential equations with infinite delay, *Electronic Journal of Differential Equations*, Vol. 2003, N^o. 116, <http://ejde.math.swt.edu>, (2003), 1-13.
- [68] K. Ezzinbi and M. Jazar, New criteria for the existence of periodic and almost periodic solutions for some evolution equations in Banach spaces, *Electronic Journal of Qualitative Theory of Differential Equations*, N^o.6, (2004), <http://www.math.u-szeged.hu/ejqtde/>, 1-12.

- [69] K. Ezzinbi and S.L.Rhali, Positivity and stability for some partial functional differential equations, *Nonlinear Differential Equations and Applications, Vol. 10, N^o. 1, (2003), 1-13.*
- [70] K. Ezzinbi and J. H. Liu, Periodic solutions of Non-Densely defined delay evolution equations, *Journal of Applied Mathematics and Stochastic Analysis, , Vol. 15, N^o. 2, (2002), 113-123.*
- [71] K.Ezzinbi anf J.H. Liu, Non-densely defined evolution equations with non local conditions, *Mathematical and Computer Modeling, 36, (2002), 1027-1038.*
- [72] W.E.Fitzgibbon, Semilinear functional differential equations in Banach space, *J. Differential Equ. 29, (1978), 1-14.*
- [73] A.Grabosch and U.Moustakas, A semigroup approach to retarded differential equations, in " One-Parameter Semigroups of Positive Operators (R.Nagel, ed.), p 219-232, *Lecture Notes in Mathematics, Vol. 1184, Springer-Verlag, Berlin/New York, (1986).*
- [74] J.K.Hale, Theory of functional differential equations *Springer-Verlag, New York, (1977).*
- [75] J.K.Hale and S.Lunel, Introduction to functional differential equations, *Springer-Verlag, New York (1993).*
- [76] M.Hieber, Integrated semigroups and diff. operators on L^p , *Dissertation, (1989).*
- [77] T.Kato, Perturbation theory for linear operators, *Springer, Berlin (1966).*
- [78] K.Kunish and W.Schappacher, Variation-of-constants formula for partial differential equations with delay, *Nonlinear Anal. TMA 5, (1981), 123-142.*
- [79] K.Kunish and W.Schappacher, Necessary conditions for partial differential equations with delay to generate a C_0 -semigroups, *J.D.E 50, (1983), 49-79.*
- [80] H. Kellermann, Integrated Semigroups, *Dissertation, Tübingen, (1986).*
- [81] H.Kellermann and M.Hieber, Integrated semigroup, *J.Fun.Anal., 15, (1989), 160-180.*

- [82] M.Memory, Stable and unstable manifolds for partial functional differential equations, *Nonlinear Analysis, Theory, Methods and Applications*, 16, (1991), 131-142.
- [83] M.Memory, Invariant manifolds for partial functional differential equations, In *Mathematical Population Dynamics (Eds. O.Arino, D.E.Axelrod and M.Kimmel) (1991), 223-232, Marcel-Dekker.*
- [84] R. Nagel, One-parameter Semigroups of Positive Operators, *Lect. Notes in Mathematics, Springer-Verlag, 1184, (1986).*
- [85] R. Nagel and E. Sinestrari, Nonlinear hyperbolic Volterra integrodifferential equations, *Nonlinear Anal. TMA, Vol.27, No.2, (1996), 167-186.*
- [86] F.Neubrandner, Integrated semigroups and their applications to the abstract Cauchy problems, *Pacific, J. Math.*, 135, (1988), 111-155.
- [87] M.E. Parrrot, Positivity and a principle of linearized stability for delay differential equations, *J. Diff. and Integ. Equa.*, 2, (1989), 170-182.
- [88] M.E. Parrrot, Linearized stability and irreducibility for a functional differential equation, *SIAM J. Math. Anal.*, 23, (1992), 649-661.
- [89] A.Pazy, Semigroups of linear operators and applications to partial differential equations, *Springer, Berlin (1983).*
- [90] W.M. Ruess and W. H. Summers, Linearized stability for abstract differential equations with delay, *Journal of Mathematical Analysis and Applications*, 198, (1996), 310-336.
- [91] E.Sinestrari, On the abstract Cauchy problem of parabolic type in spaces of continuous functions; *Journal of .Mathematical .Analysis and .Applications*, 107 (1985), 16-66.
- [92] H.Thieme, Integrated semigroups and integrated solutions to abstract Cauchy problems, *Journal of .Mathematical .Analysis and .Applications*, 152, (1990), 416-447.
- [93] H.Thieme, Semiflows generated by Lipschitz perturbations of non-densely defined operators, *Diff. Integr. Equations* 3, No.6, (1990), 1035-1066.

- [94] C.C.Travis and G.F.Webb, Existence and stability for partial functional differential equations, *Trans. Amer. Math. Soc.* 200, (1974), 395-418.
- [95] G.F.Webb, Asymptotic stability for abstract functional differential equations, *Proc. Amer. Math.Soc.* 54 (1976), 225-230.
- [96] J. Wu, Theory and Applications of Partial Functional Differential Equations, *Springer-Verlag*, (1996).

IV

**MORE ON DELAY DIFFERENTIAL
EQUATIONS AND APPLICATIONS**

Chapter 10

DYNAMICS OF DELAY DIFFERENTIAL EQUATIONS

H.O. Walther

Mathematisches Institut

Universität Giessen

Arndtstr. 2

D 35392 Giessen

Germany

Hans-Otto.Walther@math.uni-giessen.de

1. Basic theory and some results for examples

Proofs for most of the basic results presented in this part are found in the monograph [57]. See also [105].

1.1 Semiflows of retarded functional differential equations

Let $h > 0, n \in \mathbb{N}$. Let C denote the Banach space $C([-h, 0], \mathbb{R}^n)$, with $\|\phi\| = \max_{-h \leq s \leq 0} |\phi(s)|$. The space C will serve as state space. For $x : \mathbb{R} \supset I \rightarrow \mathbb{R}^n$ and $t \in \mathbb{R}$ with $[t - h, t] \subset I$, the *segment* $x_t : [-h, 0] \rightarrow \mathbb{R}^n$ is the shifted restriction of x to the *initial interval* $[-h, 0]$,

$$x_t(s) = x(t + s) \text{ for } s \in [-h, 0].$$

Autonomous retarded functional differential equations on C (RFDEs) are equations of the form

$$\dot{x}(t) = f(x_t),$$

for a given map $f : C \supset U \rightarrow \mathbb{R}^n$. In the sequel we shall assume that $U \subset C$ is open and that f is locally Lipschitz continuous. Some results require that f is continuously differentiable. Solutions $x : [t_0 - h, t_e] \rightarrow \mathbb{R}^n$, $-\infty < t_0 < t_e \leq \infty$, of the previous RFDE are continuous, differentiable on (t_0, t_e) , and satisfy the RFDE for $t_0 < t < t_e$. This implies

that their right derivative at t_0 exists and equals $f(x_{t_0})$. Solutions on $(-\infty, t_e)$ (including on \mathbb{R}) are differentiable and satisfy the RFDE everywhere.

A *maximal solution* $x^\phi : [t_0 - h, t_e(\phi)) \rightarrow \mathbb{R}^n$ of the initial value problem (IVP)

$$\dot{x}(t) = f(x_t), x_0 = \phi \in U,$$

is a solution of the RFDE which satisfies the initial condition and has the property that any other solution of the same IVP is a restriction of x^ϕ .

Example. Let $\mu \in \mathbb{R}$ and a continuously differentiable function $g : \mathbb{R} \rightarrow \mathbb{R}$ be given. The equation

$$\dot{x}(t) = -\mu x(t) + g(x(t-1)) \quad (1.1)$$

is an RFDE, with $h = 1$, $n = 1$, and $f(\phi) = -\mu \phi(0) + g(\phi(-1))$ for all $\phi \in C$. Solutions are easily found via the method of steps: For $\phi \in C$ given, evaluate successively the variation-of-constants formulae

$$x(t) = e^{-\mu(t-n)}x(n) + \int_n^t e^{-\mu(t-s)}f(x(s-1))ds,$$

for nonnegative integers n and $n \leq t \leq n+1$, with $x_0 = \phi$. This yields the maximal solution $x^\phi : [-1, \infty) \rightarrow \mathbb{R}$ of the IVP for eq. (1.1). - If $g(0) = 0$ then $x : \mathbb{R} \ni t \mapsto 0 \in \mathbb{R}$ is a constant solution (equilibrium solution). For $\mu > 0$ and

$$\xi g(\xi) < 0 \text{ for all } \xi \neq 0$$

eq. (1.1) models a combination of delayed negative feedback and instantaneous negative feedback with respect to the zero solution. The condition

$$\xi g(\xi) > 0 \text{ for all } \xi \neq 0$$

corresponds to delayed positive (and instantaneous negative) feedback.

In case of negative feedback and $\mu \geq 0$, initial data with at most one zero define *slowly oscillating* solutions, which have any two zeros spaced at a distance larger than the delay $h = 1$.

How is slowly oscillating behaviour reflected in the state space C ? Segments x_t of slowly oscillating solutions belong to the set $S \subset C \setminus \{0\}$ of

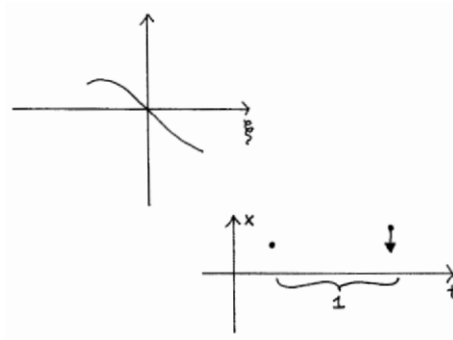

Figure 10.1.

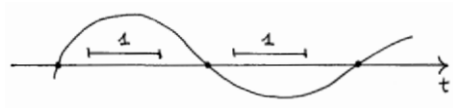

Figure 10.2.

initial data with at most one change of sign. More precisely, $\phi \neq 0$, and $0 \leq \phi$, or $\phi \leq 0$, or there are $j \in \{0, 1\}$ and $a \in [-1, 0]$ so that

$$0 \leq (-1)^j \phi(t) \text{ on } [-1, a], \quad (-1)^j \phi(t) \leq 0 \text{ on } [a, 0].$$

The set S is positively invariant, i.e., for all $\phi \in S$ and all $t \geq 0$, $x_t^\phi \in S$. We have

$$cl S = S \cup \{0\},$$

and

$$(0, \infty) \cdot S \subset S$$

which says that S is a wedge. It can be shown that S is homotopy equivalent to the circle; S is *not* convex. See [240].

Let us call a solution *eventually* slowly oscillating if for some t its zeros $z \geq t$ are spaced at distances larger than the delay $h = 1$. The main result of [177] establishes that in case $\mu \geq 0$, g bounded from below or from above, and

$$g'(\xi) < 0 \text{ for all } \xi \in \mathbb{R}$$

almost every initial function $\phi \in C$ defines a solution which is eventually slowly oscillating. More precisely, the set R of data whose maximal

solutions are not eventually slowly oscillating is closed and a graph

$$T \supset \text{dom} \rightarrow Q$$

with respect to a decomposition of C into a closed subspace T of codimension 2 and a 2-dimensional complementary subspace Q . This shows that the set $C \setminus R$ of initial data of eventually slowly oscillating solutions is open and dense in C .

Remark. For certain bounded but non-monotone functions g and for certain $\mu > 0$ there exist *rapidly oscillating* periodic solutions with attracting orbits [116]. This means that for such g and μ the previous statement is false.

Problem. Does the density result hold in case $\mu = 0$ for *all* g which satisfy the negative feedback condition ?

We shall see that in case of negative feedback slowly oscillating *periodic* solutions play a prominent role in the dynamics generated by eq.(1.1). In a simple case, which was excluded from the considerations up to here, they are easily found.

Exercises. Define and compute a 'slowly oscillating periodic solution' of eq. (1.1) for $\mu = 0$ and the step function $g = -\text{sign}$. Then compute a slowly oscillating periodic solution for a suitable *smooth* function g which is positive and constant on some interval $(-\infty, -a]$ and linear and decreasing on some interval $[-b, \infty)$, $0 < b < a$.

In case of *positive feedback*, the convex cones of nonnegative and non-positive data are positively invariant. See [137].

Back to the general case. The maximal solutions of the IVP with $t_0 = 0$ define a continuous semiflow

$$F : \Omega \rightarrow U,$$

$$F(t, \phi) = x_t^\phi$$

and

$$\Omega = \{(t, \phi) \in [0, \infty) \times U : t < t_e(\phi)\}.$$

The domain Ω is open in $[0, \infty) \times U$. Recall the algebraic semiflow properties

$$F(0, \phi) = \phi \text{ and}$$

$F(t, F(s, \phi)) = F(t+s, \phi)$ whenever $\phi \in U, 0 \leq s < t_e(\phi), 0 \leq t < t_e(F(s, \phi))$.

The solution maps $F_t = F(t, \cdot), t \geq 0$, are defined on the open sets $\Omega_t = \{\phi \in U : (t, \phi) \in \Omega\}$. For certain $t > 0, \Omega_t$ may be empty.

Remark. A flow does not exist in general, as there are no backward solutions for nondifferentiable initial data. Also, initially different solutions may become identical on some ray $[t, \infty)$. Therefore solutions of the backward IVP are in general not uniquely determined.

Example. Eq. (1.1) with g constant on a nontrivial interval I , initial data $\phi \neq \psi$ with range in I and $\phi(0) = \psi(0)$.

Before discussing differentiability with respect to initial data a look at *nonautonomous* linear delay differential equations is convenient: Let $L : [t_0, t_e) \times C \rightarrow \mathbb{R}^n, t_0 < t_e \leq \infty$, be continuous and assume all maps $L(t, \cdot)$ are linear. Solutions of the equation

$$\dot{y}(t) = L(t, y_t)$$

are defined as before. Maximal solutions exist and are defined on $[t_0 - h, t_e)$.

Suppose f is continuously differentiable. For a given maximal solution $x = x^\phi : [t_0 - h, t_e(\phi)) \rightarrow \mathbb{R}^n$ of an IVP associated with the nonlinear RFDE above the *variational equation along x* is the previous linear equation with

$$L(t, \psi) = Df(x_t)\psi \text{ for } t_0 \leq t < t_e(\phi), \psi \in C.$$

Example. Let $g(0) = 0$. The variational equation along the zero solution of eq. (1.1), or *linearization at 0*, is

$$\dot{v}(t) = -\mu v(t) + \alpha v(t - 1) \tag{1.2}$$

with $\alpha = g'(0)$.

In case f is continuously differentiable all solution operators F_t on non-empty domains are continuously differentiable, and for all $\phi \in \Omega_t, \chi \in C$,

$$DF_t(\phi)\chi = v_t^{\phi, \chi}$$

with the maximal solution $v^{\phi, \chi} : [-h, t_e(\phi)) \rightarrow \mathbb{R}^n$ of the IVP

$$\dot{v}(s) = Df(F(s, \phi))v_s, v_0 = \chi.$$

On the open subset of Ω given by $t > h$ the semiflow F is continuously differentiable, with

$$D_1F(t, \phi)1 = \dot{x}_t^\phi.$$

I.e., for $t > h$ the tangent vectors of the *flowline*

$$[0, t_e(\phi)) \ni t \mapsto F(t, \phi) \in U$$

exist and are given by the derivatives of the solution segments. Notice that for $0 \leq t < h$ the solution segments are in general only continuous and not differentiable.

1.2 Periodic orbits and Poincaré return maps

Let a periodic solution $x : \mathbb{R} \rightarrow \mathbb{R}^n$ of the RFDE be given. Assume f is continuously differentiable. Let $p > h$ be a period of x , not necessarily minimal. A transversal to the periodic orbit

$$o = \{x_t : t \in [0, p]\} \subset U$$

at $x_0 = x_p$ is a hyperplane $H = x_0 + L$, with a closed subspace L of codimension 1, so that

$$D_1F(p, x_0)1 \notin L = T_{x_0}H.$$

Recall that L is the kernel of a continuous linear functional ϕ^* . The relation $F(t, \phi) \in H$ is equivalent to the equation

$$\phi^*(F(t, \phi) - x_0) = 0.$$

An application of the Implicit Function Theorem close to the solution (p, x_0) yields an open neighbourhood N of x_0 in C and a continuously differentiable *intersection map*

$$\tau : N \rightarrow \mathbb{R}$$

so that $\tau(x_0) = p$ and

$$F(\tau(\phi), \phi) \in H \text{ for all } \phi \in N.$$

The *Poincaré return map*

$$P : H \cap N \ni \phi \mapsto F(\tau(\phi), \phi) \in H$$

is continuously differentiable (with respect to the C^1 -submanifold structures on $H \cap N$ and H).

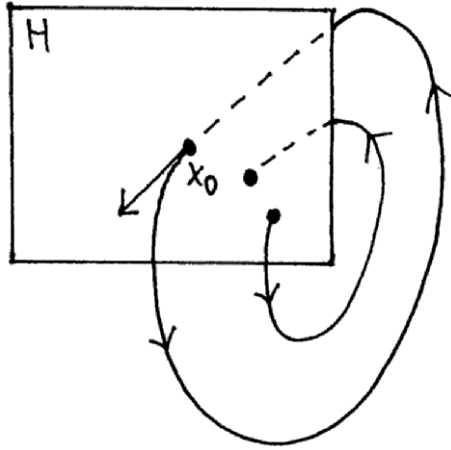

Figure 10.3.

The derivatives $DP(\phi)\chi$, $\phi \in H \cap N$ and $\chi \in T_\phi H = L$, are given by

$$pr_\phi \circ DF_{\tau(\phi)}(\phi)\chi$$

where $pr_\phi : C \rightarrow L$ is the projection along the (tangent) vector

$$\eta = D_1F(\tau(\phi), \phi)1 = \dot{x}_{\tau(\phi)}^\phi \notin L.$$

We have

$$pr_\phi \psi = \psi - \frac{\phi^* \psi}{\phi^* \eta} \eta.$$

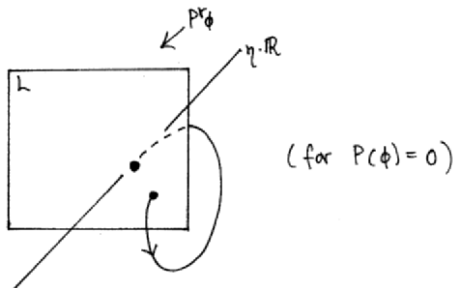

Figure 10.4.

In particular,

$$DP(x_0)\chi = pr_{x_0} DF_p(x_0)\chi.$$

1.3 Compactness

Often the solution maps F_t , $t \geq h$, are compact in the sense that they map bounded sets into sets with compact closure. ($F_0 = id_U$ is not compact, due to $\dim C = \infty$).

Example. Eq. (1.1) with g bounded from above or from below. Compactness follows by means of the Ascoli-Arzelà Theorem from simple a-priori bounds on solutions and their derivatives.

Also Poincaré maps are often compact. It follows that all these maps are *not* diffeomorphisms. Therefore standard tools of dynamical systems theory on finite-dimensional manifolds, which had originally been developed for diffeomorphisms only, e.g., local invariant manifolds, inclination lemmas, and the shadowing lemma associated with a hyperbolic set, had to be generalized in a suitable way for differentiable, not necessarily invertible maps in Banach spaces.

1.4 Global attractors

Consider a semiflow $F : [0, \infty) \times M \rightarrow M$ on a complete metric space M . A *complete flowline* is a curve $u : \mathbb{R} \rightarrow M$ so that

$$F(t, u(s)) = u(t + s) \text{ for all } t \geq 0, s \in \mathbb{R}.$$

A set $I \subset M$ is *invariant* if each $x \in I$ is a value of a complete flowline u with $u(\mathbb{R}) \subset I$. This is equivalent to

$$F_t(I) = I \text{ for all } t > 0.$$

A (*compact*) *global attractor* A for F is a compact invariant set $A \subset M$ which attracts bounded sets in the sense that for every bounded set $B \subset M$ and for every open set $V \supset A$ there exists $t \geq 0$ such that $F(s, B) \subset V$ for all $s \geq t$.

Exercise. A global attractor contains each bounded set $B \subset M$ which satisfies $B \subset F(t, B)$ for all $t > 0$.

It follows from the exercise that a global attractor A contains every compact invariant set, and that it is uniquely determined. Furthermore, A coincides with the set of all values of all bounded complete flowlines.

Existence of global attractors is in some cases easy to verify. Consider for example eq. (1) with $\mu > 0$ and $g : \mathbb{R} \rightarrow \mathbb{R}$ injective and bounded.

Then all solution maps are injective, and F_1 is compact. For $r > 1 + (\sup |g|)/\mu$ the open ball C_r in C with radius $r > 0$ and center 0 is positively invariant under the semiflow and absorbs every flowline in the sense that for every $\phi \in C$ there exists $t \geq 0$ with $F(s, \phi) \in C_r$ for all $s \geq t$. The set

$$A = \overline{\bigcap_{t \geq 0} F(t, C_r)}$$

is the global attractor [137].

1.5 Linear autonomous equations and spectral decomposition

For $L : C \rightarrow \mathbb{R}^n$ linear continuous, consider the RFDE

$$\dot{y}(t) = Ly_t.$$

The semiflow is now given by the C_0 -semigroup of solution operators $T_t : C \ni \phi \mapsto y_t^\phi \in C, t \geq 0$. The domain of its generator $G : D_G \rightarrow C$ is

$$D_G = \{\phi \in C : \phi \text{ continuously differentiable, } \dot{\phi}(0) = L\phi\},$$

and $G\phi = \dot{\phi}$. The solution behaviour is determined by the spectrum of the generator. The solution operators are compact for $t \geq h$, and the complexification of G has compact resolvents. So the spectrum σ of G consists of a countable number of isolated eigenvalues of finite multiplicities, which are real or occur in complex conjugate pairs. The Ansatz $y(t) = e^{\lambda t} c$ for a solution leads to a *characteristic equation* for the eigenvalues. Example: For eq. (1.2),

$$\lambda + \mu - \alpha e^{-\lambda} = 0.$$

An important property is that any halfplane given by an equation

$$Re \lambda > \beta$$

for $\beta \in \mathbb{R}$ contains at most a finite number of eigenvalues.

Examples. For eq. (1.2) with $\mu = 0, \alpha < -\frac{\pi}{2}$ (negative feedback), there exist pairs of complex conjugate eigenvalues with positive real part, and there are no real eigenvalues. In case $\mu > 0$ and $\alpha > 0$ (positive feedback) the eigenvalue with largest real part is positive and all other eigenvalues form complex conjugate pairs.

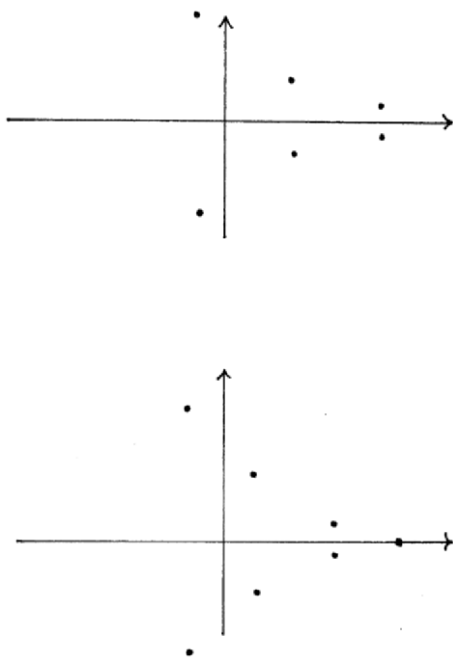

Figure 10.5.

Rapid growth of the imaginary parts of the eigenvalues as $Re \lambda \rightarrow -\infty$ shows that G is not sectorial, and that the semigroup is *not* analytic.

The realified generalized eigenspaces associated with a real eigenvalue or a pair of complex conjugate eigenvalues are positively invariant under the semigroup, as well as generalized eigenspaces $C_{<\beta}$ associated with all eigenvalues in a left halfplane given by an equation

$$Re \lambda < \beta,$$

with $\beta \in \mathbb{R}$. On the finite-dimensional generalized eigenspace $C_{\geq\beta}$ given by the set $\sigma_{\geq\beta}$ of all eigenvalues satisfying

$$Re \lambda \geq \beta$$

the semigroup induces a group of isomorphisms $T_{t,\beta} = e^{Bt}$, $t \in \mathbb{R}$, with a linear vectorfield $B : C_{\geq\beta} \rightarrow C_{\geq\beta}$. The spectrum of B is $\sigma_{\geq\beta}$; generalized eigenspaces of an eigenvalue with respect to G and B coincide. On the complementary subspace $C_{<\beta}$,

$$\|T_t\phi\| \leq k e^{\beta t} \|\phi\|, \quad t \geq 0,$$

with $k = k(L, \beta) \geq 0$.

The unstable, center, and stable subspaces C^u, C^c, C^s of G are the realified generalized eigenspaces given by the sets $\sigma_{>0}, \sigma_0, \sigma_{<0}$ of the eigenvalues with positive, zero, and negative real part, respectively. C^u consists of segments of solutions on the line which decay to 0 exponentially as $t \rightarrow -\infty$ and whose segments grow exponentially as $t \rightarrow \infty$. C^c consists of segments of solutions with polynomial growth. Solutions starting in C^s decay exponentially to 0 as $t \rightarrow \infty$. We have

$$C = C^u \oplus C^c \oplus C^s.$$

The semigroup is called *hyperbolic* if there are no eigenvalues on the imaginary axis.

Examples of other spectral decompositions of C . Consider eq. (1.2). In the case $\mu \geq 0$ and $\alpha < 0$ (negative feedback), there is a *leading pair* of eigenvalues, i.e., there exists $\beta \in \mathbb{R}$ so that the sum of the multiplicities of the eigenvalues with $Re \lambda > \beta$ is 2. For convenience we choose β so that there are no eigenvalues on $\beta + i\mathbb{R}$. For the leading eigenvalues,

$$|Im \lambda| < \pi,$$

and all solutions with segments in the 2-dimensional space

$$C_2 = C_{>\beta}$$

are slowly oscillating. Solutions on the line with segments in realified generalized eigenspaces associated with other complex conjugate pairs of eigenvalues are *not* slowly oscillating. Later we shall consider the decomposition

$$C = C_2 \oplus C_{2<}$$

where $C_{2<} = C_{<\beta}$. We have

$$C_2 \subset S \cup \{0\}$$

and

$$S \cap C_{2<} = \emptyset.$$

See [240].

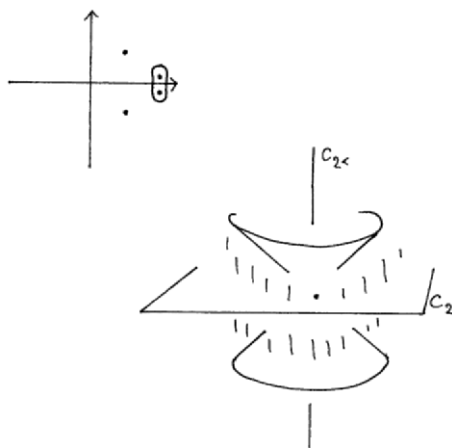

Figure 10.6.

In the result from [177] on density of initial data for eventually slowly oscillating solutions of the nonlinear eq. (1.2), we actually have $T = C_{2<}$ and $Q = C_2$, for the space T containing the domain *dom* of the map representing the thin set R of segments of rapidly oscillating solutions and for the target space Q of this map. Of course, $C_{2<}$ and C_2 are here defined by the variational equation (1.2) along the zero solution of eq. (1.1).

In the positive feedback case $\mu \geq 0$ and $\alpha > 0$, with α sufficiently large, there are at least 3 eigenvalues in the open right halfplane. Choose $\beta > 0$ so that the 3 eigenvalues with largest real parts satisfy $\beta < \text{Re } \lambda$, and there are no eigenvalues on $\beta + i\mathbb{R}$. The solutions on the line with segments in

$$C_3 = C_{>\beta}$$

have at most 2 zeros in any interval of length $h = 1$, and they decay to 0 as $t \rightarrow -\infty$ faster than $t \mapsto e^{\beta t}$. Later we shall consider the decomposition

$$C = C_3 \oplus C_{3<}$$

where $C_{3<} = C_{<\beta}$. See [137].

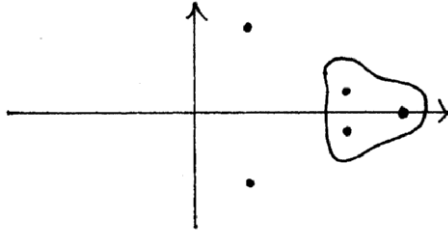

Figure 10.7.

1.6 Local invariant manifolds for nonlinear RFDEs

Assume f is continuously differentiable, and $f(\phi_0) = 0$. For simplicity, $\phi_0 = 0$. Then the zero function on the line is a solution, and $0 \in U$ is a *stationary point* of the semiflow: $F(t, 0) = 0$ for all $t \geq 0$. The linear variational equation along the zero solution is given by

$$L = Df(0).$$

There exist open neighbourhoods N^u, N^c, N^s of 0 in the spaces C^u, C^c, C^s , respectively, and continuously differentiable maps

$$w^u : N^u \rightarrow C^c \oplus C^s, w^c : N^c \rightarrow C^u \oplus C^s, w^s : N^s \rightarrow C^u \oplus C^c$$

with fixed point 0 and zero derivatives at 0 whose graphs

$$W^* = \{\chi + w^*(\chi) : \chi \in N^*\}$$

are *locally positively invariant* under the semiflow F . This means that there is a neighbourhood N of 0 so that flowlines starting in $N \cap W^*$ remain in W^* as long as they stay in N . The *local unstable manifold* W^u consists of segments of solutions $x : (-\infty, t_e) \rightarrow \mathbb{R}^n$ which decay to 0 exponentially as $t \rightarrow -\infty$. Conversely, all such solutions with all segments in a neighbourhood of 0 in C have their segments in W^u . All bounded solutions on the line which remain sufficiently small have all their segments in W^c . All solutions which start in W^s decay to 0 exponentially as $t \rightarrow \infty$, and the segments of all solutions on $[-h, \infty)$ which remain in a neighbourhood of 0 and tend to 0 exponentially as $t \rightarrow \infty$ belong to W^s .

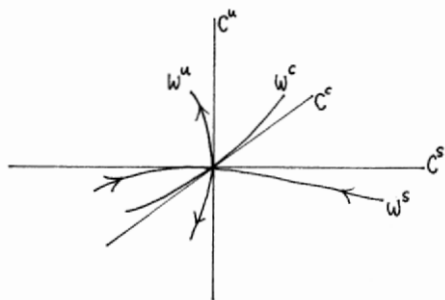

Figure 10.8.

In case all eigenvalues have negative real part, one obtains the *Principle of Linearized Stability*, i.e., asymptotic stability of the linearized equation implies the same for the equilibrium of the original nonlinear equation.

The local unstable and stable manifolds are unique (in a certain sense) while local center manifolds are not.

It is also possible to begin with a splitting of σ not at $\beta = 0$. Consider again eq. (1.1) with $\mu > 0$ and $\alpha > 0$ sufficiently large (positive feedback), so that there are at least 3 eigenvalues in the open right half-plane. Then there exists a 3-dimensional *leading local unstable manifold* W_3 , i.e., a locally positively invariant C^1 -submanifold of C with

$$T_0 W_3 = C_3$$

which consists of segments of solutions on intervals $(-\infty, 0]$ which tend to 0 as $t \rightarrow -\infty$ faster than $t \rightarrow e^{\beta t}$. See [137].

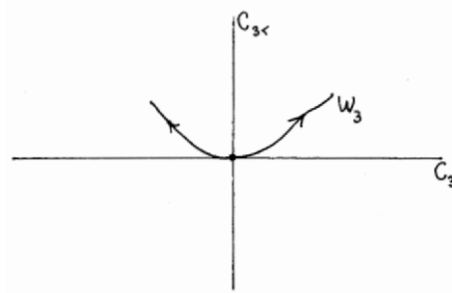

Figure 10.9.

Remark: If a global attractor exists then local unstable manifolds and their forward extensions by the semiflow belong to the global attractor.

1.7 Floquet multipliers of periodic orbits

Assume f is continuously differentiable, and let a periodic solution $x : \mathbb{R} \rightarrow \mathbb{R}^n$ and a period $p > h$ of x be given. The associated *Floquet multipliers* are the nonzero points in the spectrum (of the complexification) of the *monodromy operator*

$$M = D_2F(p, x_0).$$

They can be used to describe the behaviour of flowlines close to the periodic orbit

$$o = \{x_t : 0 \leq t \leq p\}.$$

The number 1 is a Floquet multiplier; an eigenvector in C is

$$\dot{x}_0 = \dot{x}_p = D_1F(p, x_0)1.$$

The periodic orbit is called *hyperbolic* if 1 is an eigenvalue with 1-dimensional generalized eigenspace, and if there are no other Floquet multipliers on the unit circle. In case of hyperbolicity and if there are no Floquet multipliers outside the unit circle, the periodic orbit o is *exponentially stable with asymptotic phase*, which means in particular that there are a neighbourhood $N \subset U$ of o , constants $k \geq 0, \gamma > 0$, and a function $\theta : N \rightarrow \mathbb{R}$ so that for all $\phi \in N$ and all $t \geq 0$,

$$\|F(t, \phi) - x_{t+\theta(\phi)}\| \leq k e^{-\gamma t}.$$

If there are Floquet multipliers outside the unit circle then the periodic orbit is unstable.

If P is a Poincaré return map on a transversal $H = x_0 + L$ and if x_0 is a fixed point of P then the spectral properties of $DP(x_0) : L \rightarrow L$ and those of the monodromy operator are closely related, due to the formula

$$DP(x_0) = pr_{x_0} \circ M|L.$$

The simplest case is that M is compact and hyperbolicity holds. Then the Floquet multipliers $\lambda \neq 1$ and their multiplicities coincide with the eigenvalues of $DP(x_0)$ and their multiplicities. Without hyperbolicity, 1 becomes an eigenvalue of $DP(x_0)$ with a realified generalized eigenspace of reduced dimension.

The compactness assumption can be relaxed. In the most general case, however, several natural questions concerning monodromy operators and Poincaré maps seem not yet discussed in the literature, to the best of my knowledge.

How can one obtain results about Floquet multipliers? If $\mu = 0$ and if g is odd and bounded with $|g'(0)|$ sufficiently large then eq. (1.1) has periodic solutions with rational periods [120]. In the negative feedback case, one finds, among others, slowly oscillating periodic solutions of minimal period 4, with the additional symmetry

$$x(t) = -x(t - 2).$$

It follows that the associated monodromy operator has

$$V = D_2F(2, x_0)$$

as a root; the Floquet multipliers are squares of the eigenvalues of V . For the latter, a characteristic equation is found in the following way: Suppose

$$V\phi = \lambda\phi, \phi \neq 0.$$

Then the segments v_0, v_1, v_2 of the solution $v = v^{x_0, \phi}$ of the variational equation along x satisfy

$$\dot{v}_2 = g'(x(1+t))v_1, \dot{v}_1 = g'(t)v_0$$

and

$$v_2 = \lambda v_0.$$

Substitute $v_0 = \lambda^{-1}v_2$ in the last differential equation. Then (v_2, v_1) satisfies

$$\dot{v}_2 = g'(x(1+t))v_1, \dot{v}_1 = \lambda^{-1}g'(x(t))v_2$$

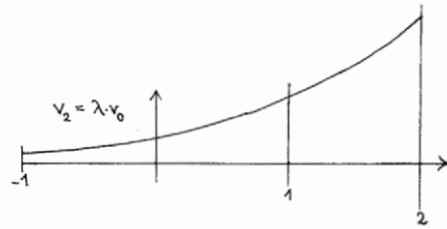

Figure 10.10.

and the nonlocal boundary conditions

$$v_2(-1) = v_1(0), \quad v_1(-1) = (v_0(0) =) \lambda^{-1} v_2(0).$$

Using a fundamental matrix solution of the ODE system one finds that a certain determinant, which depends on the parameter λ through the fundamental matrix solution and through the boundary conditions, must vanish. This is the desired characteristic equation. Though there is no explicit formula and the dependence on the underlying periodic solution x seems rather involved it was possible to make use of the characteristic equation, first in a proof of bifurcation from a continuum of period-4-solutions of a one-parameter family of delay differential equations [238], and later in the search for hyperbolic stable [43] and unstable [115] period-4-solutions. The latter were used in the first proof that chaotic behaviour of slowly oscillating solution exists for certain smooth nonlinearities g of negative feedback type [153, 154]. See also [59, 60].

In recent work, more general characteristic equations for periodic solutions with arbitrary rational periods were developed. A first application was to show that for certain $\mu > 0$ and special nonlinearities g of negative feedback type the orbits of some slowly oscillating periodic solutions with minimal period 3 are hyperbolic and stable [211]. It is planned to extend the method in order to establish that certain *unstable* rapidly oscillating periodic solutions of eq. (1.1) with $\mu > 0$ and g representing positive feedback are hyperbolic; the period in this case is $5/4$.

In cases where period and delay are incommensurable characteristic equations for Floquet multipliers seem unknown.

LOCAL INVARIANT MANIFOLDS OF CONTINUOUSLY DIFFERENTIABLE
MAPS IN BANACH SPACES

We also need local invariant manifolds for continuously differentiable maps $f : E \supset U \rightarrow E$ on open subsets of Banach spaces (over \mathbb{R}). Suppose for simplicity that $f(0) = 0$, and that the (compact) spectrum of the derivative $Df(0)$ is the disjoint union of its compact parts outside, on, and inside the unit circle. Then E is the direct sum of the associated realified generalized eigenspaces E^u, E^c, E^s , i.e., of the *unstable, center, and stable* linear spaces, respectively. Assume

$$\dim E^u < \infty, \dim E^c < \infty.$$

The derivative $Df(0)$ induces isomorphisms of the unstable and center spaces and an endomorphism of the stable space. With respect to an equivalent norm on E the isomorphism on the unstable space is an expansion and the map on the stable space is a contraction. There are open neighbourhoods N_u, N_c, N_s of 0 in E^u, E^c, E^s , respectively, and continuously differentiable maps

$$w_u : N_u \rightarrow E^c \oplus E^s, \quad w_c : N_c \rightarrow E^u \oplus E^s, \quad w_s : N_s \rightarrow E^u \oplus E^c,$$

with $w_*(0) = 0$ and $Dw_*(0) = 0$, so that the *local unstable, center, and stable manifolds*

$$W_* = \{x + w_*(x) : x \in N_*\}$$

are locally positively invariant with respect to f and have further properties analogous to the locally invariant manifolds for the semiflow introduced above.

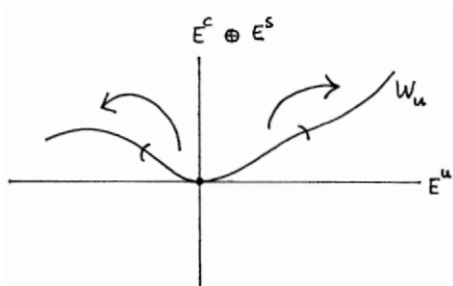

Figure 10.11.

For example, W_u consists of endpoints of trajectories $(x_j)_-\infty^0$ of f which tend to 0 as $j \rightarrow -\infty$, and there exist $k \geq 0$ and $q \in (0, 1)$ so that

$$\|x_j\| \leq k q^{-j} \|x_0\|$$

along all such trajectories. Conversely, any trajectory $(x_j)_-\infty^0$ in some neighbourhood of 0 in E which for $j \rightarrow -\infty$ converges to 0 at a certain rate belongs to W_u .

Using the equivalent norm one can construct W_u and W_s in such a way that f induces a diffeomorphism from a convex open neighbourhood of 0 in W_u onto W_u and maps W_s into W_s . With respect to the new norm the inverse diffeomorphism and the map induced on W_s are contractions.

See [103] for local unstable and stable manifolds, and compare the results in the appendices in [137]. The latter contain a proof of the following natural result on *local center-stable manifolds*, which to my knowledge and surprise was not available elsewhere in the literature.

THEOREM. There exist convex open bounded neighbourhoods N_{sc} of 0 in $E^c \oplus E^s$, N_u of 0 in E^u , N of 0 in U , and a continuously differentiable map $w_{sc} : N_{sc} \rightarrow E^u$ with $w_{sc}(0) = 0$, $Dw_{sc}(0) = 0$, and $w_{sc}(N_{sc}) \subset N_u$ so that the set

$$W_{sc} = \{z + w_{sc}(z) : z \in N_{sc}\}$$

satisfies

$$f(W_{sc} \cap N) \subset W_{sc}$$

and

$$\bigcap_{n=0}^{\infty} f^{-n}(N_{sc} + N_u) \subset W_{sc}.$$

The proof employs a method due to Vanderbauwhede and van Gils [231].

The fixed point 0 - and the linear map $Df(0)$ - are called *hyperbolic* if there is no spectrum on the unit circle. Then $E^c = \{0\}$.

In case of a semiflow F as before and a stationary point, say $\phi_0 = 0$ for simplicity, we have local invariant manifolds for the solution maps F_t at the fixed point 0 as well as for the semiflow.

Exercise. Show that local unstable and stable manifolds of solution operators coincide with local unstable and stable manifolds for the semi-

flow, respectively.

The situation for center manifolds is more subtle. There exist center manifolds W_c for solution maps which are *not* locally positively invariant under the semiflow [133].

HYPERBOLIC SETS, SHADOWING, AND CHAOTIC TRAJECTORIES OF CONTINUOUSLY DIFFERENTIABLE MAPS IN BANACH SPACES

Let E denote a real Banach space. Consider an open set $U \subset E$ and a continuously differentiable map $f : U \rightarrow E$. A *hyperbolic set* H of f is a positively invariant subset of U together with a uniformly continuous and bounded projection-valued map $pr : H \rightarrow L_c(E, E)$ and constants $k \geq 1, q \in (0, 1)$ so that the *unstable spaces* $E_u^x = pr(x)$ and the *stable spaces* $E_s^x = (id - pr)(x), x \in H$ have the following properties:

$$Df(x)E_s^x \subset E_s^{f(x)},$$

$$E = Df(x)E_u^x + E_s^{f(x)},$$

$$\|pr(f^n(x)) \circ Df^n(x)v\| \geq k^{-1}q^{-n}\|v\| \text{ for all } n \in \mathbb{N}, v \in E_u^x,$$

$$\|Df^n(x)v\| \leq kq^n\|v\| \text{ for all } n \in \mathbb{N}, v \in E_s^x.$$

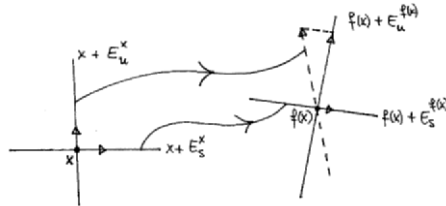

Figure 10.12.

See [219, 220] and [149]. So the derivative maps stable spaces into stable spaces, but not necessarily unstable spaces into unstable spaces. Concerning subsequent unstable spaces it is only required that the projections of transported vectors grow, not the iterated vectors themselves. This is weaker than in the classical definition for diffeomorphisms in finite-dimensional spaces, and can be verified for certain Poincaré return maps which do not have hyperbolic sets in the classical sense.

The triple (pr, k, q) is called *hyperbolic structure*.

For our hyperbolic sets the *Shadowing Lemma* remains valid in full generality. It asserts that under a weak additional smoothness condition on the map f , for a given hyperbolic set H and for every sufficiently small $\epsilon > 0$ there exists $\delta > 0$ so that each δ -pseudotrajectory $(y_n)_{-\infty}^{\infty}$ in H ,

$$\|y_{n+1} - f(y_n)\| < \delta \text{ for all integers,}$$

is accompanied by a unique trajectory $(w_n)_{-\infty}^{\infty}$ of f ,

$$\|w_n - y_n\| \leq \epsilon \text{ for all integers.}$$

See [219, 149]. The shadowing trajectory does in general not belong to H .

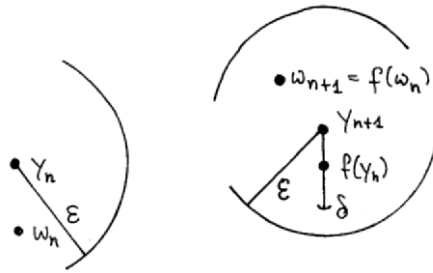

Figure 10.13.

Very roughly, the Shadowing Lemma makes it possible to establish complicated trajectory behaviour by prescribing complicated pseudotrajectories, provided the hyperbolic set H is rich enough for this.

A fundamental scenario going back to Poincaré (1899, in the diffeomorphism case) for which one can find a hyperbolic structure is the following. Suppose f has a hyperbolic fixed point p with local unstable manifold W_u and local stable manifold W_s , and there is a homoclinic trajectory $(x_n)_{-\infty}^{\infty}$, i.e.,

$$x_n \rightarrow p \text{ as } |n| \rightarrow \infty,$$

$x_0 \neq p$. Assume also the *transversality condition* that there exists $n_0 \in \mathbb{N}$ so that for all integers $m < -n_0$ and $n > n_0$, we have $x_m \in W_u, x_n \in W_s$, and

$$Df^{n-m}(x_m)T_{x_m}W_u \text{ is a closed complement of } T_{x_m}W_s.$$

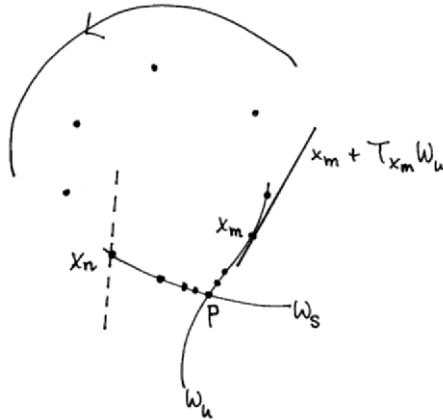

Figure 10.14.

Under these conditions the *homoclinic loop*

$$HL = \{p\} \cup \{x_n : n \in \mathbb{Z}\}$$

is a hyperbolic set [220].

By the way, it is not excluded that eventually $x_n = p$. This occurs, e.g., for chaotic interval maps.

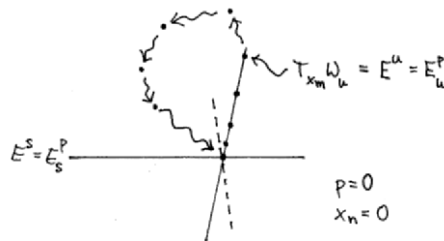

Figure 10.15.

By means of shadowing one can then prove that chaotic trajectories close to the homoclinic loop HL exist. The precise statement of the result requires preparations, including elementary facts from *symbolic dynamics*. Let $J \in \mathbb{N}$. Consider the *space of symbols* $\Sigma_J = \{1, \dots, J\}$ with the discrete topology. The product space

$$S_J = (\Sigma_J)^{\mathbb{Z}}$$

of bi-infinite sequences in the symbol space is compact, and the *Bernoulli shift* $\sigma_J : S_J \rightarrow S_J$ given by

$$\sigma_J((a_n)_{n \in \mathbb{Z}}) = (a_{n+1})_{n \in \mathbb{Z}}$$

is a homeomorphism with dense trajectories and infinitely many periodic orbits. This is a prototype of chaotic behaviour.

Let $M \in \mathbb{N}$ be given and consider the compact subset $S_{JM} \subset S_J$ which consists of all symbol sequences composed of pieces of at least M consecutive symbols 0, alternating with pieces of the form $12 \dots J$. On S_{JM} , the Bernoulli shift induces a homeomorphism which still has dense trajectories and infinitely many periodic orbits.

As f may not be invertible, it can not be expected that on given subsets $V \subset U$ the map f itself is conjugate to the homeomorphism σ_{JM} . This difficulty is circumvented by the following construction. Consider the set T_{fV} of *complete trajectories* $(w_n)_{n \in \mathbb{Z}} \in V^{\mathbb{Z}}$ of f in a given open subset $V \subset U$, equipped with the product topology from $V^{\mathbb{Z}}$. T_{fV} is a closed subset of $V^{\mathbb{Z}}$. The shift induced by f on its bi-infinite trajectories in V , i.e., the map

$$\sigma_{fV} : T_{fV} \ni (w_n)_{n \in \mathbb{Z}} \mapsto (w_{n+1})_{n \in \mathbb{Z}} \in T_{fV}$$

is a homeomorphism.

THEOREM [220]. There exist positive integers J and $M \geq 2$ and mutually disjoint open subsets V_0, \dots, V_J of U with the following properties: $p \in V_0$, $HL \subset \bigcup_0^J V_j = V$, and for every $(w_n)_{n \in \mathbb{Z}} \in T_{fV}$,

$$w_n \in V_0 \text{ and } w_{n+1} \notin V_0 \text{ imply } w_{n+1} \in V_1,$$

$$w_n \in V_j \text{ and } j \in \{1, \dots, J-1\} \text{ imply } w_{n+1} \in V_{j+1},$$

$$w_n \in V_J \text{ implies } w_{n+\mu} \in V_0 \text{ for all } \mu \in \{1, \dots, M\}.$$

The map $\alpha : T_{fV} \rightarrow S_{JM}$ given by

$$\alpha((w_n)_{n \in \mathbb{Z}}) = (a_n)_{n \in \mathbb{Z}}, \quad a_n = j \text{ if and only if } w_n \in V_j,$$

is a homeomorphism which conjugates the shifts σ_{fV} and σ_{JM} :

$$\alpha \circ \sigma_{fV} = \sigma_{JM} \circ \alpha.$$

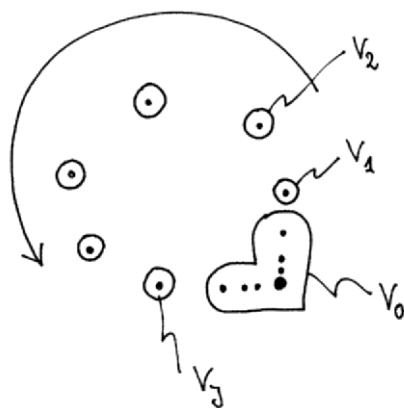
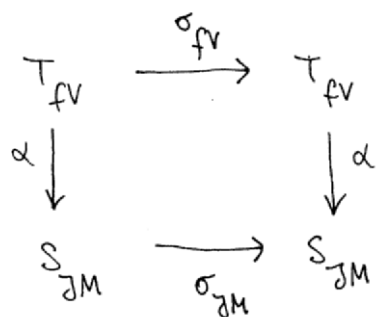

Figure 10.16.

1.8 Differential equations with state-dependent delays

Modelling sometimes leads to equations of the form

$$\dot{x}(t) = g(x(t - r(x_t)))$$

with a map $g : \mathbb{R}^n \supset \text{dom} \rightarrow \mathbb{R}^n$ and a *delay functional* r which is defined on some set of functions $\phi : [-h, 0] \rightarrow \mathbb{R}^n$ and has values in $[0, h]$, for some $h > 0$. Of course, more complicated versions occur also. E.g., the right hand side may also depend on $x(t)$ and on further delayed values of x . - Let us see why the associated IVP does *not* fit into the framework presented before.

The differential equation with state-dependent delay rewritten as a RFDE is

$$\dot{x}(t) = f(x_t)$$

with

$$f = g \circ ev \circ (id \times (-r)),$$

where

$$r : U \rightarrow [0, h]$$

is assumed to be defined on a subset $U \subset C$, and

$$ev : C \times [-h, 0] \rightarrow \mathbb{R}^n$$

is the *evaluation map* given by

$$ev(\phi, s) = \phi(s).$$

The problem is that such f in general does not satisfy the previous smoothness hypotheses, no matter how smooth g and r are. A 'reason' for this may be seen in the fact that the middle composite ev is not smooth: Lipschitz continuity of ev would imply Lipschitz continuity of elements $\phi \in C$. Differentiability would imply that

$$D_2 ev(\phi, s)1 = \dot{\phi}$$

exists.

Therefore the existence and smoothness results designed for IVPs of RFDEs on C are not applicable. If C is replaced with the smaller Banach space $C^1 = C^1([-h, 0], \mathbb{R}^n)$ of continuously differentiable functions $\phi : [-h, 0] \rightarrow \mathbb{R}^n$, with the usual norm given by

$$\|\phi\|_1 = \|\phi\| + \|\dot{\phi}\|,$$

then the smoothness problem disappears since the restricted evaluation map

$$Ev : C^1 \times [-h, 0] \rightarrow \mathbb{R}^n$$

is continuously differentiable, with

$$D_1 Ev(\phi, s)\chi = Ev(\chi, s) \quad \text{and} \quad D_2 Ev(\phi, s)1 = \dot{\phi}(s).$$

So, for g and $r : U \rightarrow [0, h]$, $U \subset C^1$ open, both continuously differentiable, the resulting map $f : U \rightarrow \mathbb{R}^n$ is continuously differentiable.

However, if we now look for solutions of the IVP with initial values in the open subset $U \subset C^1$, a new difficulty arises. Suppose this IVP is well-posed. The maximal solution $x^\phi : [-h, t_e(\phi)) \rightarrow \mathbb{R}^n$ would have continuously differentiable segments. Hence x^ϕ itself would be continuously differentiable, and the flowline $[0, t_e(\phi)) \ni t \mapsto x_t^\phi \in C^1$ would be continuous. At $t = 0$ we get

$$\dot{\phi}(0) = \dot{x}(0) = f(x_0) = f(\phi),$$

which in general is *not* satisfied on *open* subsets of the space C^1 . (Notice however that for $f = p$, $p : C^1 \ni \phi \mapsto \dot{\phi}(0) \in \mathbb{R}^n$ the equation is trivially satisfied on C^1 .)

In order to obtain a continuous semiflow - and differentiable solution operators - for a reasonable class of RFDEs covering differential equations with state-dependent delays, it seems necessary to restrict the state space further [247, 249]. What to do and what can be achieved will be the topic of the last of these lectures.

2. Monotone feedback: The structure of invariant sets and attractors

Consider eq. (1.1),

$$\dot{x}(t) = -\mu x(t) + g(x(t-1)),$$

with $\mu \geq 0$ and with a continuously differentiable function $g : \mathbb{R} \rightarrow \mathbb{R}$ which satisfies

$$g(0) = 0,$$

and either

$$g'(\xi) < 0 \quad \text{for all } \xi \in \mathbb{R}$$

(negative feedback) or

$$g'(\xi) > 0 \quad \text{for all } \xi \in \mathbb{R}$$

(positive feedback). The strict monotonicity properties are essential for all results explained in this part. Assume also that g is bounded from below or from above. Equations of this type arise in various applications, e.g., in neural network theory.

2.1 Negative feedback

Recall the positively invariant wedge

$$\bar{S} = S \cup \{0\} \subset C$$

of data with at most one change of sign, which contains all segments of slowly oscillating solutions and absorbs the flowlines of eventually slowly oscillating solutions. Recall also that \bar{S} contains the 2-dimensional leading realified generalized eigenspace C_2 of the linearization at 0, while

$$S \cap C_{2<} = \emptyset.$$

Soon we shall use the decomposition

$$C = C_2 \oplus C_{2<}$$

as a co-ordinate system.

The semiflow $F : [0, \infty) \times C \rightarrow C$ induces a continuous semiflow F_S on the complete metric space \bar{S} , which has a compact global attractor $A_S \subset \bar{S}$. A compact global attractor A of F exists as well; in general, A_S is a proper subset of A . It may happen that $A_S = \{0\}$. Example: $\mu = 0$ and $-1 < g'$. If however $\mu \geq 0$ and $-g'(0)$ is sufficiently large then the leading pair of eigenvalues is in the open right halfplane, and there exists a *leading 2-dimensional local unstable manifold* W_2 of the nonlinear eq. (1.1) which is tangent to C_2 at 0. W_2 consists of segments of bounded slowly oscillating solutions on the line, and is therefore contained in A_S .

In the nontrivial case $A_S \neq \{0\}$ the attractor A_S has the following properties [240, 250]. There exists a map

$$a : C_2 \supset \bar{D}_S \rightarrow C_{2<}$$

so that

$$A_S = \{\phi + a(\phi) : \phi \in \bar{D}_S\}.$$

$D_S \subset C_2$ is an open subset of C_2 containing 0, and its boundary in C_2 is the trace of a simple closed continuously differentiable curve; the closure $\overline{D_S}$ is homeomorphic to the compact unit disk in the Euclidean plane. The map $a : \overline{D_S} \rightarrow C_{2<}$ is continuously differentiable. I.e., the restriction to the interior is continuously differentiable, and each boundary point has an open neighbourhood N in C_2 so that the restriction to $N \cap \text{int } D_S$ extends to a continuously differentiable map on N . The manifold boundary

$$bd A_S = A_S \setminus \{\phi + a(\phi) : \phi \in D_S\} = \{\phi + a(\phi) : \phi \in \partial D_S\}$$

of A_S is the orbit of a slowly oscillating periodic solution. The semiflow F_S induces a flow on A_S , with solution maps continuously differentiable on the interior part

$$\{\phi + a(\phi) : \phi \in D_S\}$$

of A_S . All flowlines of the flow except the trivial one are given by slowly oscillating solutions on the line. The periodic orbits are nested, with the stationary point 0 in the interior of each periodic orbit. The zeros of the underlying periodic solutions are simple, and the minimal periods are given by 3 successive zeros. The aperiodic orbits in $A_S \setminus \{0\}$ wind around the stationary point 0 and are heteroclinic from one periodic orbit to another, or are heteroclinic from 0 to a periodic orbit, or vice versa.

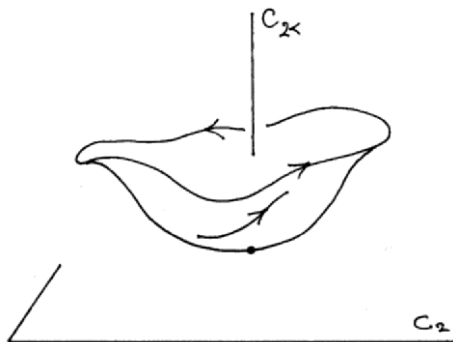

Figure 10.17.

A tiny but basic ingredient of the proof is the following consideration. The fact that A_S is a graph with respect the decomposition of C above means that the spectral projection $p_2 : C \rightarrow C_2$ along $C_{2<}$ is injective on A_S . I.e., one needs

$$0 \neq p_2(\phi - \psi) \text{ for } \phi \neq \psi \text{ in } A_S.$$

As S does not intersect the nullspace $C_{2<}$ of p_2 , it is sufficient to have

$$A_S - A_S \subset S \cup \{0\} = \bar{S}.$$

The result in [177] yields that all flowlines of F starting in the open dense set $C \setminus R$ converge to the disk A_S as $t \rightarrow \infty$.

In [239] explicit conditions on μ and g are given so that the manifold boundary is the only periodic orbit in A_S , and

$$A_S = A.$$

Graph representations of *stable* manifolds associated with periodic orbits in A_S have been obtained in [241].

2.2 Positive feedback

Let us describe in greater detail the results obtained in [137, 136, 242]. A first remark is that all solution maps F_t are injective. The semiflow is monotone with respect to the ordering on C given by the cone K of nonnegative initial data. The positively invariant set

$$\Sigma = \{\phi \in C : (x^\phi)^{-1}(0) \text{ is unbounded}\}$$

separates the domain of absorption into the interior of the positively invariant cone K from the domain of absorption into the interior of $-K$. One of the first results in [137] is that the separatrix Σ is a Lipschitz graph over a closed hyperplane in C . So, we can speak of the parts of C above and below Σ .

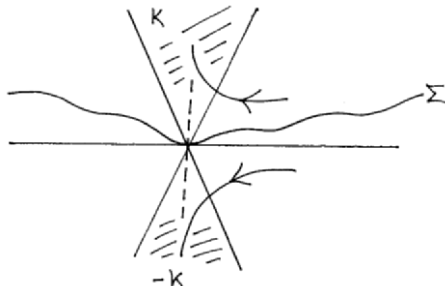

Figure 10.18.

It is not difficult to show that in case $\mu > 0$ and g bounded the semiflow has a global attractor. However, in case $\mu = 0$ every maximal

solution which starts in the interior of $K \cup (-K)$ is unbounded, and thus a global attractor does not exist. So it is natural to look for substitutes of a global attractor which are present in *all* cases of interest. These are the closure of the unstable set W^U of all segments of solutions on the line which decay to the stationary point 0 as $t \rightarrow -\infty$, and subsets thereof.

Notice that in case a global attractor A exists, necessarily $\overline{W^U} \subset A$ since for every ball B and for every $t \geq 0$, $W^U \subset F([t, \infty) \times (W^U \cap B))$, which implies that W^U is contained in every neighbourhood of the compact set A , yielding $W^U \subset \overline{A} = A$ and $\overline{W^U} \subset A$.

If μ and $g'(0)$ are such that only one eigenvalue of the generator of the semigroup given by the variational equation along the zero solution has positive real part, and all other eigenvalues have negative real part, then W^U consists of 0 and of the segments of two solutions on the line, one being positive and one negative. More structure appears when the 3 leading eigenvalues have positive real part. This situation can be characterized by an explicit inequality which involves $\mu, g'(0)$, and elementary functions only. Assume that this inequality holds. Consider the decomposition

$$C = C_3 \oplus C_{3<}$$

and the associated leading 3-dimensional local unstable manifold W_3 at 0. W_3 is tangent to C_3 at 0 and contained in W^U . The forward extension

$$W = F([0, \infty) \times W_3)$$

of W_3 is an invariant subset of W^U . What can be said about the structure of the closed invariant set \overline{W} ?

In case $\mu > 0$ two mild additional assumptions are needed. They are related to the fact that the hypothesis about the eigenvalues implies

$$g'(0) > \mu.$$

The first additional assumption is

$$\frac{g(\xi)}{\xi} < \mu \text{ for } \xi \text{ outside a bounded neighbourhood of 0.}$$

This statement and the inequality before combined show that there exist a smallest positive argument ξ^+ where g and μid intersect, and a largest negative argument ξ^- where g and μid intersect. The second additional assumption then is

$$g'(\xi^-) < \mu \text{ and } g'(\xi^+) < \mu.$$

It follows that the variational equations along the constant solutions given by ξ^-, ξ^+ define hyperbolic semigroups, with all associated eigenvalues in the open left halfplane.

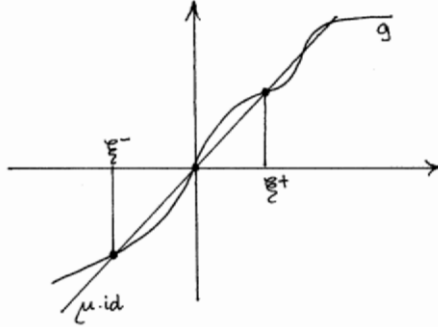

Figure 10.19.

About the shape of \overline{W} and the dynamics in \overline{W} the following has been proved. The set \overline{W} is invariant, and the semiflow defines a continuous flow $F_W : \mathbb{R} \times \overline{W} \rightarrow \overline{W}$. For \overline{W} and for the part $\overline{W} \cap \Sigma$ of the separatrix Σ in \overline{W} there are graph representations: There exist subspaces $G_2 \subset G_3$ of C of dimensions 2 and 3, respectively, a complementary space G_1 of G_2 in G_3 , a closed complementary space E of G_3 in C , a compact set $D_\Sigma \subset G_2$ and a closed set $D_W \subset G_3$, and continuous mappings $w : D_W \rightarrow E$ and $w_\Sigma : D_\Sigma \rightarrow G_1 \oplus E$ such that

$$\overline{W} = \{\chi + w(\chi) : \chi \in D_W\}, \quad \overline{W} \cap \Sigma = \{\chi + w_\Sigma(\chi) : \chi \in D_\Sigma\}.$$

Also,

$$D_W = \partial D_W \cup \text{int } D_W, \quad W = \{\chi + w(\chi) : \chi \in \text{int } D_W\},$$

and the restriction of w to $\text{int } D_W$ is continuously differentiable. The restriction of F_W to $\mathbb{R} \times W$ is continuously differentiable. The domain D_Σ is homeomorphic to the closed unit disk in the Euclidean plane, and consists of the trace of a simple closed continuously differentiable curve and its interior. The map w_Σ is continuously differentiable (in the sense explained above for the map a).

The set

$$o = (\overline{W} \cap \Sigma) \setminus (W \cap \Sigma) = \{\chi + w_\Sigma(\chi) : \chi \in \partial D_\Sigma\}$$

is a periodic orbit, and there is no other periodic orbit in \overline{W} . The open annulus $(W \cap \Sigma) \setminus \{0\}$ consists of heteroclinic connections from 0 to o .

For every $\phi \in W$, $F_W(t, \phi) \rightarrow 0$ as $t \rightarrow -\infty$.

The further properties of \overline{W} and the flow F_W are different in the cases $\mu > 0$ and $\mu = 0$.

For $\mu > 0$, \overline{W} is compact and contains the stationary points ξ_- and ξ_+ in C given by the values ξ^- and ξ^+ , respectively. For every $\phi \in \overline{W}$,

$$\xi_- \leq \phi \leq \xi_+.$$

There exist homeomorphisms from \overline{W} and from D_W onto the closed unit ball in \mathbb{R}^3 , which send the *manifold boundary*

$$bdW = \overline{W} \setminus W = \{\chi + w(\chi) : \chi \in \partial D_W\}$$

and ∂D_W onto the unit sphere $S^2 \subset \mathbb{R}^3$. Consider χ_- and χ_+ given by $\xi_- = \chi_- + w(\chi_-)$ and $\xi_+ = \chi_+ + w(\chi_+)$. The set $\partial D_W \setminus \{\chi_-, \chi_+\}$ is a 2-dimensional continuously differentiable submanifold of G_3 , and the restriction of w to $D_W \setminus \{\chi_-, \chi_+\}$ is continuously differentiable. This means that the restriction to $int D_W$ is continuously differentiable, and that each boundary point except χ_-, χ_+ has an open neighbourhood N in G_3 so that the restriction of w to $N \cap int D_W$ extends to a continuously differentiable map on N . The points $\phi \in \overline{W} \setminus \Sigma$ above the separatrix Σ form a connected set and satisfy $F_W(t, \phi) \rightarrow \xi_+$ as $t \rightarrow \infty$, and all $\phi \in \overline{W} \setminus \Sigma$ below the separatrix Σ form a connected set and satisfy $F_W(t, \phi) \rightarrow \xi_-$ as $t \rightarrow \infty$. Finally, for every $\phi \in bdW$ different from ξ_- and ξ_+ , $F_W(t, \phi) \rightarrow 0$ as $t \rightarrow -\infty$.

Combining some of the results stated above, one obtains for $\mu > 0$ the following picture: \overline{W} is a smooth solid spindle which is split by an invariant disk in Σ into the basins of attraction towards the tips ξ_- and ξ_+ .

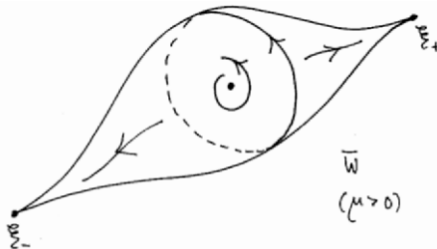

Figure 10.20.

In case $\mu = 0$ the sets \overline{W} and D_W are unbounded. There exist homeomorphisms from \overline{W} and from D_W onto the solid cylinder $\{z \in \mathbb{R}^3 : z_1^2 + z_2^2 \leq 1\}$ which send $bd W$ and ∂D_W onto the cylinder $S^1 \times \mathbb{R} \subset \mathbb{R}^3$. The boundary ∂D_W is a 2-dimensional continuously differentiable submanifold of G_3 , and w is continuously differentiable. The points $\phi \in \overline{W} \setminus \Sigma$ above the separatrix Σ form a connected set and satisfy $x^\phi(t) \rightarrow \infty$ as $t \rightarrow \infty$, and the points $\phi \in \overline{W} \setminus \Sigma$ below Σ form a connected set and satisfy $x^\phi(t) \rightarrow -\infty$ as $t \rightarrow \infty$. Finally, for every $\phi \in bd W$, $F_W(t, \phi) \rightarrow o$ as $t \rightarrow -\infty$.

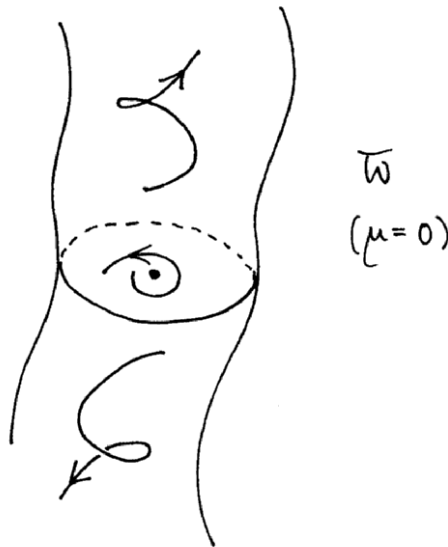

Figure 10.21.

We turn to aspects of the proof. The first steps exploit the monotonicity of the semiflow. Among others we obtain that in case $\mu > 0$ the set \overline{W} is contained in the order interval between the stationary points ξ_- and ξ_+ , and that there are heteroclinic connections from 0 to ξ_- and ξ_+ , given by monotone solutions $x : \mathbb{R} \rightarrow \mathbb{R}$.

A powerful tool for the investigation of finer structures is a version of the discrete Lyapunov functional $V : C \setminus \{0\} \rightarrow \mathbb{N}_0 \cup \{\infty\}$ counting sign changes of data $\phi \in C$, which was introduced by Mallet-Paret [171]. Related are a-priori estimates for the growth and decay of solutions with segments in level sets and sublevel sets of V , which go back to [171] and in a special case to [236, 237]. These tools are used to characterize

the invariant sets $W \setminus \{0\}$ and $(W \cap \Sigma) \setminus \{0\}$ as the sets of segments x_t of solutions $x : \mathbb{R} \rightarrow \mathbb{R}$ which decay to 0 as $t \rightarrow -\infty$ and satisfy $V(x_t) \leq 2$ for all $t \in \mathbb{R}$ and $V(x_t) = 2$ for all $t \in \mathbb{R}$, respectively. Moreover, nontrivial differences of segments in \overline{W} and $\overline{W} \cap \Sigma$ belong to $V^{-1}(\{0, 2\})$ and $V^{-1}(2)$, respectively. The last facts make it possible to introduce global coordinates on \overline{W} and $\overline{W} \cap \Sigma$. It is not difficult to show injectivity for the continuous linear evaluation map

$$\Pi_2 : C \ni \phi \mapsto (\phi(0), \phi(-1))^{tr} \in \mathbb{R}^2$$

on $\overline{W} \cap \Sigma$, and injectivity on \overline{W} for a continuous linear evaluation map $\Pi_3 : C \rightarrow \mathbb{R}^3$. The map Π_3 is given by

$$\Pi_3 \phi = (\phi(0), \phi(-1), c(\phi))^{tr}$$

and

$$(p_1 \phi)(t) = \frac{1}{1 + g'(0)e^{-\lambda}} c(\phi) e^{\lambda t},$$

where p_1 is the spectral projection onto the realified one-dimensional generalized eigenspace C_1 of the *leading* eigenvalue λ associated with the linearization at 0. The inverse maps of the restrictions of Π_2 and Π_3 to $\overline{W} \cap \Sigma$ and \overline{W} , respectively, turn out to be locally Lipschitz continuous.

The next step leads to the desired graph representation. Guided by the results on negative feedback equations it seems natural to expect that there exists a map from a subset of $C_3 = T_0 W_3$ into $C_{3<}$ which represents \overline{W} , and a map from a subset of the realified 2-dimensional generalized eigenspace L of the complex conjugate pair of eigenvalues next to λ into the complementary space $C_1 \oplus C_{3<}$ which represents $\overline{W} \cap \Sigma$. A map of the first kind had been constructed for W by Ammar in case $\mu = 0$ [11]. Our attempts to obtain the second map failed, however. Therefore we abandoned the decomposition

$$C = C_3 \oplus C_{3<}, \quad C_3 = C_1 \oplus L$$

as a framework for graph representations. Instead, $\mathbb{R}^3 \supset \Pi_3 \overline{W}$ and $\mathbb{R}^2 \supset \Pi_2(\overline{W} \cap \Sigma)$ are embedded in a simple way as subspaces $G_3 \supset G_2$ into C , so that representations by maps w and w_Σ with domains in G_3 and G_2 and ranges in complements E of G_3 in C and $E \oplus G_1$ of G_2 in C , $G_1 \subset G_3$, become obvious. It is not hard to deduce that W is given by the restriction of w to an open set, and that this restriction is continuously differentiable. On \overline{W} , the semiflow extends to a flow $F_W : \mathbb{R} \times \overline{W} \rightarrow \overline{W}$, and F_W is continuously differentiable on the manifold $\mathbb{R} \times W$.

Phase plane techniques apply to the coordinate curves in \mathbb{R}^2 (or G_2) which correspond to flowlines of F_W in the invariant set $\overline{W} \cap \Sigma$, and yield the periodic orbit

$$o = (\overline{W} \cap \Sigma) \setminus (W \cap \Sigma),$$

as well as the identification of $\Pi_2(W \cap \Sigma)$ with the interior of the trace $\Pi_2 o$. It follows that $W \cap \Sigma$ is given by the restriction of w_Σ to an open subset of G_2 .

The investigation of the smoothness of the part $W \cap \Sigma$ of the separatrix Σ in W and of the manifold boundary $bd W = \overline{W} \setminus W$ begins with a study of the stability of the periodic orbit o . We use the fact that there is a heteroclinic flowline in $W \cap \Sigma$ from the stationary point 0 to the orbit o , i.e., in the level set $V^{-1}(2)$, in order to show that precisely one Floquet multiplier lies outside the unit circle. It also follows that the center space of the monodromy operator $M = D_2F(\omega, p_0)$, $p_0 \in o$ and $\omega > 0$ the minimal period, is at most 2-dimensional. The study of the linearized stability of the periodic orbit o is closely related to earlier work in [153] and to a-priori results on Floquet multipliers and eigenspaces for general monotone cyclic feedback systems with delay which are due to Mallet-Paret and Sell [176].

A first idea how to show that the graph $W \cap \Sigma \subset V^{-1}(2) \cup \{0\}$ is continuously differentiable might be to consider the family of 2-dimensional local invariant submanifolds with tangent space L at the stationary point $0 \in C$, and to look for a member formed by heteroclinics connecting 0 with the periodic orbit o . The approach in [137] is quite different. We consider a transversal Y of o at some point $p_0 \in o$ and a Poincaré return map with domain in Y and fixed point p_0 . It is shown that pieces of $W \cap \Sigma$ in Y are open sets in the transversal intersection of W with a local center-stable manifold of the Poincaré return map.

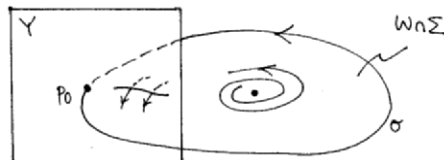

Figure 10.22.

Then we use the flow F_W to obtain continuous differentiability of the set $(W \cap \Sigma) \setminus \{0\}$. Differentiability and continuity of the derivative at 0

and the relation

$$T_0(W \cap \Sigma) = L$$

follow by other arguments which involve a-priori estimates and an inclination lemma.

A technical detail of the approach just described concerns center-stable manifolds W_{cs} and one-dimensional center manifolds W_c at fixed points of continuously differentiable maps. In case there is a forward trajectory in $W_{cs} \setminus W_c$ which converges to the fixed point we construct positively invariant open subsets of W_{cs} .

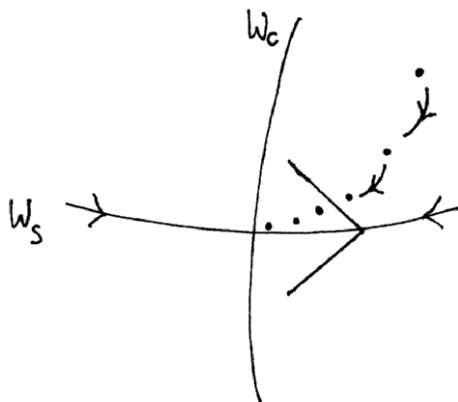

Figure 10.23.

Having established continuous differentiability of $W \cap \Sigma$ it is then shown in case $\mu > 0$ that the set $bdW \setminus \{\xi_-, \xi_+\}$, i.e., the manifold boundary without the stationary points ξ_-, ξ_+ , coincides with the forward semiflow extension of a local unstable manifold of the period map F_ω at a fixed point $p_0 \in o$. For $\mu = 0$ the full manifold boundary has the same property. The long proof of these facts involves the charts Π_2 and Π_3 and uses most of the results obtained before.

The next step achieves the continuous differentiability of a piece of \overline{W} in a transversal H of the periodic orbit o . We construct a continuously differentiable graph over an open set in a plane $X_{12} \subset H$ which extends such a piece of $\overline{W} \cap H$ close to a point $p_0 \in o \cap H$ beyond the boundary. Using the flow F_W we then derive that $\overline{W} \setminus \{\xi_-, \xi_+\}$ and $\overline{W} \cap \Sigma$ are continuously differentiable, in the sense stated before.

The final steps lead to the topological description of \overline{W} . In case $\mu > 0$ the identification of $bdW \setminus \{\xi_-, \xi_+\}$ as forward extension of a local un-

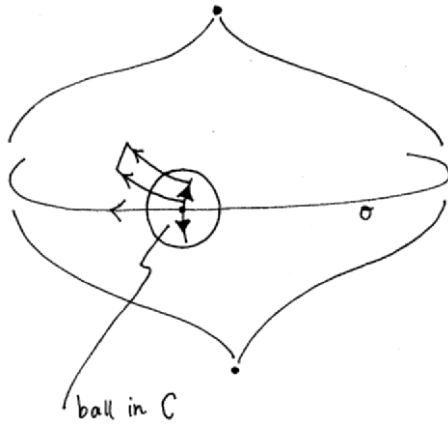

Figure 10.24.

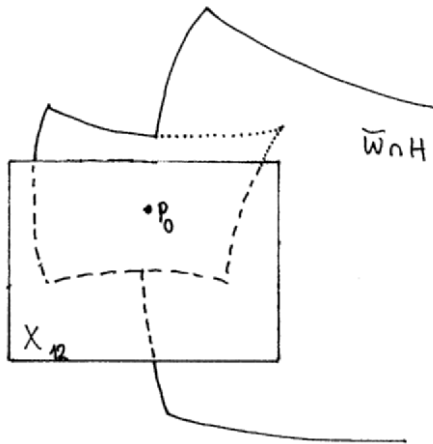

Figure 10.25.

stable manifold is used to define homeomorphisms from bdW onto the unit sphere $S^2 \subset \mathbb{R}^3$. Then a generalization due to Bing [29] of the Schoenflies theorem [210] from planar topology is employed to obtain homeomorphisms from \overline{W} onto the closed unit ball in \mathbb{R}^3 . The application of Bing's theorem requires to identify the bounded component of the complement of the set

$$\Pi_3(bdW) \cong S^2$$

in \mathbb{R}^3 as the set Π_3W , and to verify that Π_3W is uniformly locally 1-connected. This means that for every $\epsilon > 0$ there exists $\delta > 0$ so that every closed curve in a subset of Π_3W with diameter less than δ can be continuously deformed to a point in a subset of Π_3W with diameter less than ϵ . We point out that the proof of this topological property relies on the smoothness of the set $\overline{W} \setminus \{\xi_-, \xi_+\}$, and involves subsets of boundaries of neighbourhoods of $0, \xi_-, \xi_+$ in W which are transversal to the flow F_W . In order to construct these smooth boundaries we have to go back to the variation-of-constants formula for RFDEs in the framework of sun-dual and sun-star dual semigroups [57]. In case $\mu = 0$ the construction of the desired homeomorphism from \overline{W} onto the solid cylinder is different but uses Bing's theorem as well.

What can be said about \overline{W} close to the attracting stationary points ξ_-, ξ_+ ? Consider ξ_+ . The inclusion

$$\overline{W} \subset \xi_+ - K$$

implies that the tangent cone $T_0\overline{W}$ is the singleton $\{0\}$; therefore \overline{W} and bdW are not smooth at ξ_+ .

Let C_{1+} denote the leading realified one-dimensional generalized eigenspace associated with the variational equation along the solution $\mathbb{R} \ni t \mapsto \xi^+ \in \mathbb{R}$. Analogously L_+ is the realified 2-dimensional generalized eigenspace of the next pair of eigenvalues, and $C_{3<+}$ is given by the remaining eigenvalues. We have

$$C_{1+} = \mathbb{R} \cdot \eta_+$$

with $\eta_+ \in C$ a segment of the associated *positive* decreasing exponential solution of the variational equation.

In [242] the singularity ξ_+ is described in terms of the *outward tangent cone* T_+bdW , defined as the set of tangent vectors $c'(0) \in C$ of continuously differentiable curves $c : (-\epsilon, 0] \rightarrow C$, $\epsilon > 0$, in bdW ending at ξ_+ ,

and in terms of the set LTP of limit points of tangent planes $T_\phi bdW$, $\phi \neq \xi_+$, as ϕ tends to ξ_+ . We prove

$$T_+ bdW = [0, \infty) \cdot \eta_+$$

and show that LTP coincides with the set of planes in $C_{1+} \oplus L_+$ containing C_{1+} .

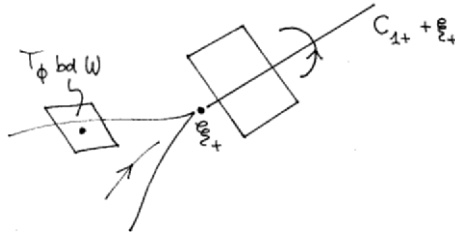

Figure 10.26.

Convergence of finite-dimensional subspaces of C is here defined by the *gap topology*, which is given by the Hausdorff distance of the compact intersections of two such spaces with the unit sphere. The proofs employ a-priori estimates and inclination lemmas.

For narrower classes of nonlinearities g and for the parameters $\mu > 0$ and $g'(0) > 0$ in a certain smaller range than before, the periodic orbit o is the only one of the semiflow, and the set \overline{W} is in fact the global attractor of F [136]. The first and basic ingredient of the proof is the uniqueness result. The equations covered include examples from neural network theory.

Let us state some open problems.

- Recall the question whether $\overline{W} \cap \Sigma$ can be represented by a smooth map from a subset of L into the complementary space $C_1 \oplus C_{3<}$.
- One may ask for diffeomorphisms instead of homeomorphisms from D_W onto the solid cylinder in case $\mu = 0$, and from $D_W \setminus \{\chi_-, \chi_+\}$ onto the unit ball without its north and south poles in case $\mu > 0$.
- The assumption $g'(\xi^-) < \mu$, $g'(\xi^+) < \mu$, which makes the semi-groups associated with the stationary points ξ_-, ξ_+ hyperbolic, might be relaxed.

- How is the global attractor organized in case \overline{W} is a proper subset?

We add a few remarks about the last question. Let us first consider situations where A is a subset of the order interval $\{\phi \in C : \xi_- \leq \phi \leq \xi_+\}$. The segments of the solutions $x : \mathbb{R} \rightarrow \mathbb{R}$ with $V(x_t) = 2$ for all $t \in \mathbb{R}$ may form, together with the stationary point 0 , a smooth disk-like submanifold A_2 in A which extends $\overline{W} \cap \Sigma$ beyond o and contains at least one additional periodic orbit, forming the manifold boundary of A_2 . In this case, the unstable sets of the periodic orbits in A_2 should be analogues of $bdW \setminus \{\xi_-, \xi_+\}$, namely 2-dimensional invariant submanifolds given by heteroclinic connections from the periodic orbit to ξ_- and ξ_+ . These submanifolds should subdivide the 3-dimensional subset $A_{\leq 2}$ of A formed by 0 and the segments of all solutions $x : \mathbb{R} \rightarrow \mathbb{R}$ with $\xi_- \leq x(t) \leq \xi_+$ and $V(x_t) \leq 2$ for all $t \in \mathbb{R}$ into invariant layers; a section of $A_{\leq 2}$ containing ξ_- and ξ_+ might have the structure shown by a sliced onion.

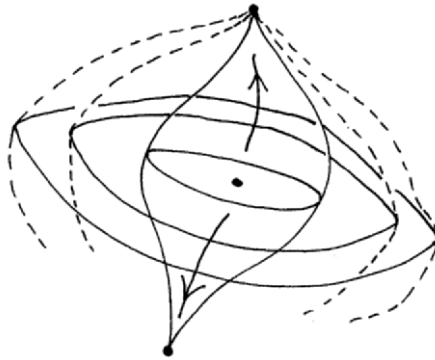

Figure 10.27.

It may be the case that $A = A_{\leq 2}$. If A is strictly larger than $A_{\leq 2}$ then we have to expect a finite number of analogues of the smooth disk A_2 , given by higher even values of V , and a more complicated variety of heteroclinic connections, between periodic orbits in the same disk, between periodic orbits in different disks, from periodic orbits and 0 to ξ_- and ξ_+ , from 0 to periodic orbits and to ξ_- and ξ_+ . Also connections from periodic orbits to 0 become possible. A Morse decomposition of A similar to the one constructed by Mallet-Paret [171] should be useful to describe a part of these heteroclinic connections.

Suppose now that A is not confined to the order interval $\{\phi \in C : \xi_- \leq \phi \leq \xi_+\}$, and there are zeros ξ^* of $g - \mu id$ below ξ_- and above ξ_+ with

$g'(\xi^*) > \mu$. One out of many possibilities is that the part of A in a certain neighbourhood of a stationary point $\xi_* \in C$ given by such a value ξ^* looks just as we began to sketch it for the case $A \subset \{\phi \in C : \xi_- \leq \phi \leq \xi_+\}$.

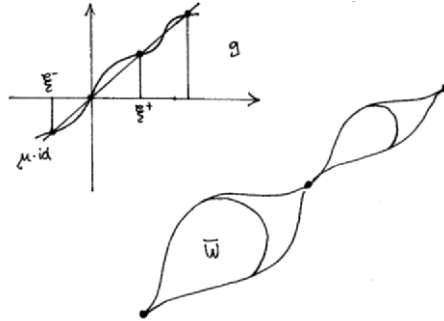

Figure 10.28.

3. Chaotic motion

This part describes steps of the proof in [153, 154], which yields existence of chaotic solution behaviour for eq. (1.1) with $\mu = 0$,

$$\dot{x}(t) = g(x(t - 1)),$$

for functions g which satisfy the negative feedback condition. The result in [154] was not the first one about existence of chaotic solutions of delay differential equations, but the first concerning slowly oscillating solutions of equations with smooth nonlinearities. The nonlinearities considered have *extrema*. Recall that monotonicity implies that the attractor A_S of almost all solutions is a disk, which excludes complicated behaviour of slowly oscillating solutions.

Nevertheless the proof begins with odd functions g which satisfy $g'(\xi) < 0$ for all $\xi \in \mathbb{R}$. For a function of this type there is a slowly oscillating periodic solution $y : \mathbb{R} \rightarrow \mathbb{R}$ with the symmetry

$$y(t) = -y(t - 2)$$

and minimal period 4, whose orbit $o \subset C$ is unstable and hyperbolic, with exactly one Floquet multiplier λ outside the unit circle [115]. This multiplier is real and simple. It follows that the *period map* F_4 has one-dimensional local center and unstable manifolds at its fixed point $y_0 = \eta$. We may assume $y(-1) = 0 < \dot{y}(-1)$. The *linear* hyperplane

$$H = \{\phi \in C : \phi(-1) = 0\}$$

is transversal to o at η . For an associated Poincaré return map the fixed point η is hyperbolic with one-dimensional local unstable manifold W_u and local stable manifold W_s of codimension 1 in H . Recall the abstract result for maps in Banach spaces which guarantees chaotic trajectories in a neighbourhood of a homoclinic loop. The plan is to verify the hypotheses of this result for a modification of the map P , whose trajectories all translate into slowly oscillating solutions of a delay differential equation as before, with a nonlinearity g^* of negative feedback type which coincides with g in a neighbourhood of the interval $y(\mathbb{R})$. The first major step is to find such functions g^* so that there is a solution $z : \mathbb{R} \rightarrow \mathbb{R}$ which is *homoclinic with respect to o* , i.e., with

$$z_t \rightarrow o \text{ as } |t| \rightarrow \infty, \quad z_0 \notin o.$$

This is done as follows.

y is increasing on the initial interval, and

$$y(0) = \|\eta\| = \max y.$$

Information about the eigenspace of the Floquet multiplier λ reveals that W_u contains the segment z_0 of a solution $z : \mathbb{R} \rightarrow \mathbb{R}$ of the original equation with

$$z(0) > y(0)$$

so that for some $\epsilon > 0$ and $\delta > 0$,

$$z(t) > y(0) + \epsilon \text{ on } (-\delta, 0], \quad z(t) < y(0) + \epsilon \text{ on } (-\infty, -\delta).$$

The key to all is now a simple observation: Any modification g^* of g in the interval $(y(0) + \epsilon, \infty)$ preserves y and the restriction of z to the interval

$$(-\infty, -\delta + 1]$$

as solutions, but affects the forward continuation of $z|_{(-\infty, -\delta + 1]}$ as a solution $z^* : \mathbb{R} \rightarrow \mathbb{R}$ of the new equation. Modifications g^* are designed in such a way that the curves $t \mapsto z_t^*$ intersect the hyperplane H close to η at some $t_* > -\delta + 1$. These modifications look rather complicated and have several extrema: 3 local maxima and 4 local minima. Intersections can be achieved *above* and *below* the local stable manifold W_s , in a carefully chosen convex open neighbourhood $N \subset H$ of η on which the original map P is also a Poincaré return map with respect to the modified delay differential equation, and

$$P(N \cap W_s) \subset N \cap W_s.$$

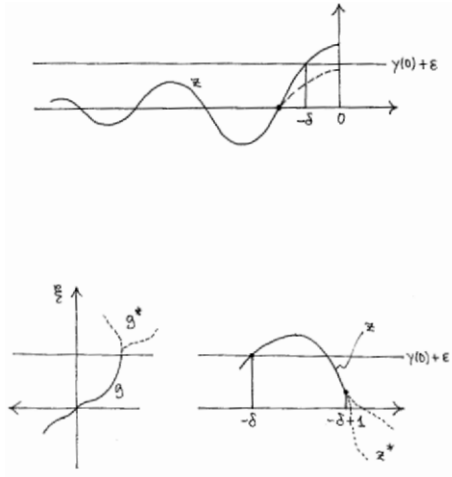

Figure 10.29.

Two such modifications g^* are connected by a one-parameter-family. Continuity yields a member so that the intersection of the curve $t \mapsto z_t^*$ with H is on W_s , and the desired nonlinearity and homoclinic solution are found.

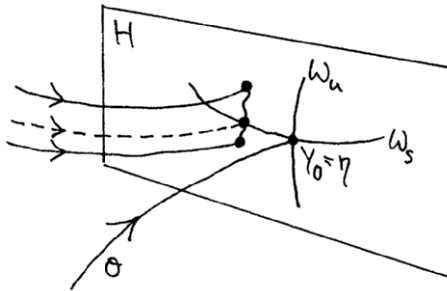

Figure 10.30.

Now the map P is modified. The neighbourhood N has the property that it contains a backward trajectory $(z_{t_j}^*)_{-\infty}^0 \in W_u$ of P so that $P(z_{t_0}^*) \notin N$; $z^*(t) = z(t)$ on $(-\infty, t_0]$. Choose a small closed ball $B^* \subset N$ centered at $z_{t_0}^* = z_{t_0} = \zeta$, with $z_{t_j}^* \notin B^*$ for $j < 0$ and so that one has an intersection map on B^* which has the value $t_* - t_0$ at ζ . Redefine P on $\text{int } B^*$ using the previous intersection map, and keep P on $N \setminus B^*$ un-

changed. Then the fixed point η and the points $z_{t_j}^*$, $j \leq 0$, $z_{t_*}^*$, $P^j(z_{t_*}^*)$, $j \in \mathbb{N}$, form a homoclinic loop of the new map P^* .

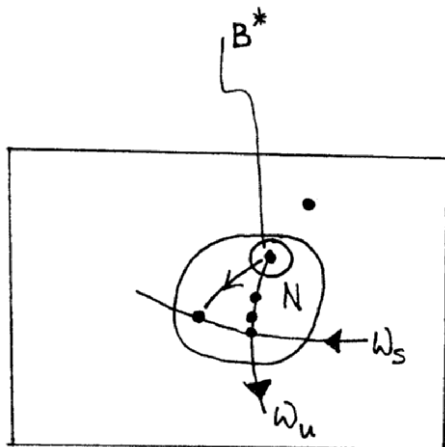

Figure 10.31.

The previous construction is in fact carried out for families of one-parameter-families of nonlinearities. This freedom is needed for the remaining part of the proof, which is to verify the transversality condition, namely, that there exists $n_0 \in \mathbb{N}$ so that for all integers $m < -n_0$ and $n > n_0$, the points ϕ_m and ϕ_n of the homoclinic trajectory of P^* belong to W_u and W_s , respectively, with

$$D(P^*)^{n-m}(\phi_m)T_{\phi_m}W_u \oplus T_{\phi_m}W_s = H.$$

In our situation, $\text{codim } W_s = 1$. In order to verify the direct sum decomposition of H we therefore need a suitable criterion for a vector in H not to be tangent to the local stable manifold W_s . 'Suitable' means that the criterion should be sufficiently explicit in terms of the nonlinearity g^* and the periodic solution y so that it can actually be applied. The first step towards the transversality criterion concerns the variational equation along y ,

$$\dot{v}(t) = g'(y(t-1))v(t-1)$$

and the monodromy operator $M = DF_4(\eta)$, $\eta = y_0$. The monotonicity of g on the range of y implies that the set S of data with at most one change of sign is again positively invariant, and that solutions $v : [-1, \infty) \rightarrow \mathbb{R}$ starting in S are eventually slowly oscillating. The realified generalized eigenspace C_{\geq} of the 2 leading Floquet multipliers on and

outside the unit circle is contained in \overline{S} ; $\dim C_{\geq} = 2$. Let Z denote the complementary subspace given by the remaining spectrum of M , i.e., the linear stable space of M . Recall that the local stable manifold $W_s(\eta)$ of the period map F_4 at η satisfies

$$T_{\eta}W_s(\eta) = Z.$$

Initial data in Z define solutions $v : [-1, \infty) \rightarrow \mathbb{R}$ with segments in $C \setminus S$. So,

$$Z \cap S = \emptyset,$$

and if a solution v is eventually slowly oscillating then $\chi = v_0 \in C \setminus Z$; in other words, the initial value is transversal to Z . Here we have a first sufficient condition for transversality, but not yet for the right map and only at a particular point of the local stable manifold. In a next step it is shown that for any $\phi \in W_s(\eta)$ and $\chi \in C$,

$$\chi \in C \setminus T_{\phi}W_s(\eta) \text{ if and only if } v^{\phi, \chi} \text{ is eventually slowly oscillating.}$$

With regard to the proof, notice that for ϕ close to η the spaces $T_{\phi}W_s(\eta)$ and Z are close. Flowlines starting in $W_s(\eta)$ converge to o as $t \rightarrow \infty$ with asymptotic phase. This yields that the coefficient function in the variational equation along $x^{\phi} : [-1, \infty) \rightarrow \mathbb{R}$, which is satisfied by $v^{\phi, \chi}$, approaches a shifted copy of the coefficient function in the variational equation along the periodic solution y . - The main tool used in the proof is an inclination lemma in a non-hyperbolic situation.

The final form of the criterion, for the Poincaré map P , is that for any $\phi \in W_s$ and any $\chi \in H$,

$$\chi \in H \setminus T_{\phi}W_s$$

if and only if

for every pair of reals $(a, b) \neq (0, 0)$, the function

$$(0, \infty) \ni t \mapsto a \dot{x}^{\phi}(t) + b v^{\phi, \chi}(t) \in \mathbb{R} \text{ is eventually slowly oscillating.}$$

Notice that for $t > 1$ the function considered here satisfies the variational equation along the solution $x^{\phi} : [-1, \infty) \rightarrow \mathbb{R}$. - The proof exploits the relation between derivatives of the Poincaré map and the period map, and the asymptotic phase for flowlines starting in W_s .

The last part of the proof that chaotic motion exists is the search for a subclass of nonlinearities g^* so that for all nonzero

$$\chi \in D(P^*)^n(\zeta)T_{\zeta}W_u$$

and for all sufficiently large integers n the sufficient condition in the previous 'transversality-by-oscillation' criterion is fulfilled.

The nonlinearities for which the proof just described works look much more complicated than the unimodal functions in versions of eq. (1.1) with $\mu > 0$ which are known from applications. A reason for this is that g^* was chosen in such a way that the curve $t \mapsto z_t^*$ through a point in W_u close to η is driven far away from o and then returns to W_s within a *short* interval of length approximately 3. In a more recent paper Lani-Wayda was able to modify the method and obtain a result for nicer-looking unimodal nonlinearities [150].

Let us mention some open problems.

- It has not yet been proved that the Mackey-Glass and Lasota-Ważewska-Czyżewska equations generate chaotic flowlines. These are equations of the form (1.1) with $\mu > 0$ and unimodal analytic nonlinearities.
- The result presented here establishes chaotic dynamics only in a small, thin set in state space, in a 'Cantor dust', whereas numerical experiments indicate that many if not almost all solutions are complicated for a variety of nonlinearities.

Other recent results on chaotic solutions of delay differential equations are due to Lani-Wayda [151] and Lani-Wayda and Szrednicki [152].

4. Stable periodic orbits

In many cases the dynamics of nonlinear autonomous delay differential equations is structured by periodic orbits. Existence of periodic orbits has been shown by several methods, notably by means of the ejective fixed point principle, by Schauder's theorem directly, by related index and continuation arguments, and by more geometric arguments (planar dynamics in the attractor of almost all solutions, Poincaré-Bendixson theorems). Much less could be achieved concerning stability and uniqueness of periodic orbits.

Consider eq. (1.1),

$$\dot{x}(t) = -\mu x(t) + g(x(t-1)),$$

for $\mu \geq 0$ and nonlinearities $g : \mathbb{R} \rightarrow \mathbb{R}$ of negative feedback type which are *continuous* or better. As in part 1, the method of steps yields maximal solutions $x : [-1, \infty) \rightarrow \mathbb{R}$ of the associated IVP and a continuous

semiflow F .

Recall that, in some contrast to the preceding remarks, there are special equations for which it is extremely easy to find slowly oscillating periodic solutions whose orbits in C seem very stable and attractive. The underlying observation for this is the following. If g is constant on some ray $[\beta, \infty)$, $\beta > 0$ and if initial data $\phi_j \in C$, $j = 1, 2$, with $\phi_j(t) \geq \beta$ coincide at $t = 0$ then the method of steps shows immediately that the corresponding solutions coincide on $[0, 1]$, and consequently for all $t \geq 0$. They depend only on the values $g(\beta)$ and $\phi(0)$. It is then easy to design nonlinearities g as above so that all segments x_t of solutions $x = x^\phi$ starting at $\phi \geq \beta$ with $\phi(0) = \beta$ return after some time $p > 0$, i.e., $x_p \geq \beta$ and $x(p) = \beta$. The segment x_p is a fixed point of the solution map F_p and defines a periodic solution which has period p and is slowly oscillating.

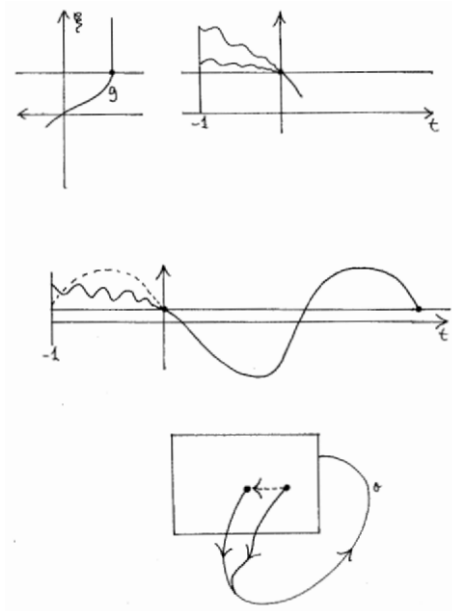

Figure 10.32.

Moreover, for every $\psi \in C$ close to $\phi = x_p$ the solution x^ψ has segments which after some time merge into the periodic orbit

$$o = \{x_t : t \in \mathbb{R}\}.$$

This expresses extremely strong attraction towards the periodic orbit. Poincaré return maps on transversals to o are locally constant, the derivative at the fixed point on o is zero, its spectrum is the singleton $\{0\}$ and the periodic orbit is hyperbolic.

What has just been said is strictly limited to equations where the nonlinearity g is constant on some interval. What happens if g is only *close* to such a function but not constant on any nontrivial interval? The approach sketched above fails. The general results on existence mentioned at the beginning may give existence, but nothing beyond. In the sequel a rather elementary method from [243] is presented which in a sense fills the gap between the easily accessible, detailed results in special cases as before, and the little information for nonlinearities which are close to these but not necessarily constant on any interval. The important property is Lipschitz continuity, which in earlier work on eq. (1.1) has not been exploited. (In case of related equations with state-dependent delay, however, Lipschitz continuity always played a role.)

Fix $\mu > 0$, $b > a > 0$. For $\beta > 0$ and $\epsilon > 0$ consider nonlinearities in the set $N(\beta, \epsilon)$ of continuous odd functions $g : \mathbb{R} \rightarrow [-b, b]$ which satisfy

$$-a - \epsilon < g(\xi) < -a + \epsilon \text{ for all } \xi \geq \beta.$$

For β and ϵ small, $g \in N(\beta, \epsilon)$ is *steep* on $(0, \beta)$, and close to $-a$ sign on $[\beta, \infty)$.

When convenient the associated semiflow will be denoted by F_g .

Initial data will be taken from the closed convex sets

$$A(\beta) = \{\phi \in C : \phi(t) \geq \beta \text{ on } [-1, 0], \phi(0) = \beta\}.$$

On $A(\beta)$ a return map can be found for β and ϵ sufficiently small.

PROPOSITION. There exists $w \in (0, 1)$ such that for β, ϵ small and for $g \in N(\beta, \epsilon)$, $\phi \in A(\beta)$ the solution $x^{\phi, g} = x^\phi$ of eq. (1) is strictly below $-\beta$ on $[w, w + 1]$. Furthermore, there exists $q = q_g(\phi) > w + 1$ so that $x^{\phi, g}$ increases on $(w + 1, q)$ and reaches the level $-\beta$ at $t = q$.

The proof relies on the fact that on $[\beta, \infty)$ and on $(-\infty, \beta]$ the function g is close to $-a$ sign and a sign, respectively. Using this and the variation-of-constants formula one sees that on $(0, 1]$ solutions starting in $A(\beta)$ lie in a narrow tongue between 2 decreasing exponentials. The method of steps yields sharp estimates of the solutions also on the next intervals of unit length. Moreover, derivatives can be estimated with

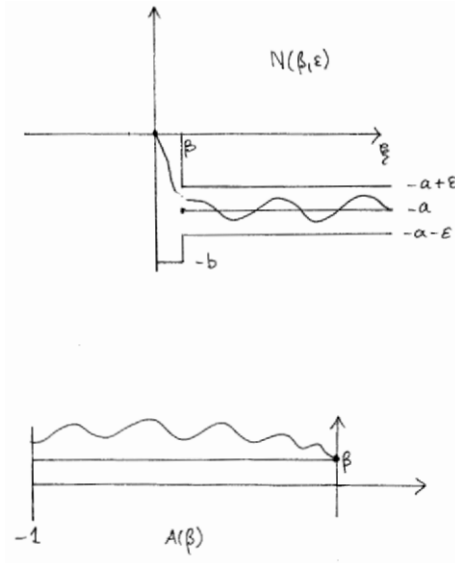

Figure 10.33.

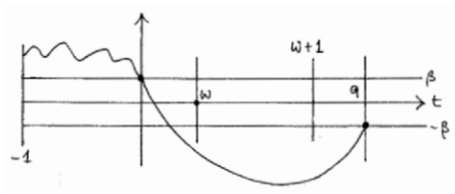

Figure 10.34.

sufficient accuracy.

The return map $R = R_g : A(\beta) \rightarrow A(\beta)$ is then given by

$$R(\phi) = -F_g(q_g(\phi), \phi).$$

Notice that g being odd any fixed point ϕ of R_g defines a slowly oscillating periodic solution $x : \mathbb{R} \rightarrow \mathbb{R}$ of eq. (1) with the symmetry

$$x(t) = -x(t + q_g(\phi)) \text{ for all } t \in \mathbb{R},$$

and minimal period $p = 2q$. Fixed points exist, due to Schauder's theorem. However, our objective is more than mere existence. Notice that up to here only continuity of the nonlinearities in eq. (1) has been used. The next objective is to find an upper estimate of the Lipschitz constant

$$L(R) = \sup_{\phi \neq \psi} \frac{\|R(\phi) - R(\psi)\|}{\|\phi - \psi\|} \leq \infty$$

of R . This is facilitated by a decomposition of $R = R_g$ into the restriction of $F_{g,1}$ to $A(\beta)$, followed by the restriction of $F_{g,w}$ to $F_{g,1}(A(\beta))$, and finally followed by the map

$$F_{g,1+w}(A(\beta)) \ni \psi \mapsto -F_g(s_g(\psi), \psi) \in A(\beta)$$

where $s = s_g(\psi)$ is defined by the equation

$$w + 1 + s = q_g(\phi) \quad \text{for all } \phi \in A(\beta) \quad \text{with } \psi = F_{g,1+w}(\phi).$$

(Observe that for all $\phi \in A(\beta)$ whose solutions coincide on $[w, w + 1]$ the argument $q_g(\phi)$ is the same - it depends only on the behaviour of the solutions on $[w, w + 1]$.)

The Lipschitz constant $L(R_g)$ will be estimated by an expression which involves the Lipschitz constant $L(g)$ of g and the Lipschitz constant

$$L_\beta(g) = L(g|[\beta, \infty)).$$

Notice that for each $g \in N(\beta, \epsilon)$, $L(g) \geq \frac{\alpha - \epsilon}{\beta}$ is large for $\beta > 0$ small. On the other hand, each $N(\beta, \epsilon)$ contains Lipschitz continuous functions g so that $L_\beta(g)$ is arbitrarily small. This will be exploited later.

We derive Lipschitz estimates of the composites of the return map R_g for $g \in N(\beta, \epsilon)$, with β and ϵ sufficiently small.

PROPOSITION. $L(F_{g,1}|A(\beta)) \leq L_\beta(g)$.

The proof is almost obvious from the facts that for ϕ, ψ in $A(\beta)$ the variation-of-constants formula says

$$\begin{aligned} F_{g,1}(\phi)(t) - F_{g,1}(\psi)(t) &= x^{\phi,g}(1+t) - x^{\psi,g}(1+t) \\ &= 0 - 0 + \int_0^{1+t} e^{-\mu(1+t-s)}(g(\phi(s-1)) - g(\psi(s-1)))ds, \end{aligned}$$

and that the arguments of g belong to $[\beta, \infty)$. In the same way one finds the next result.

PROPOSITION. $L(F_{g,w}|F_{g,1}(A(\beta))) \leq 1 + w L(g)$.

The difference to the previous proposition is due to the fact that arguments of $F_{g,w}$ may differ at $t = 0$, and traverse the interval $[-\beta, \beta]$ where g is steep. One time unit later large deviations of one solution from another become possible.

Next we need an estimate of the Lipschitz constant of the intersection map s_g .

PROPOSITION.

$$L(s_g) \leq \frac{1 + e^\mu L_\beta(g)}{a - \epsilon - \beta \mu e^\mu}$$

The proof begins with the fact that for $\psi = F_{g,w+1}(\phi)$ with $\phi \in A(\beta)$ there is an equation defining $q_g(\phi)$ and $s_g(\psi)$,

$$\beta = x^{\phi,g}(q_g(\phi)) = x^{\phi,g}(1 + w + s_g(\psi)).$$

The last term is evaluated by the variation-of-constants formula on $[1 + w, 1 + w + s_g(\psi)]$. The resulting equation for $s_g(\psi)$ and for some $s_g(\bar{\psi}), \bar{\psi} = F_{g,1+w}(\bar{\phi}), \bar{\phi} \in A(\beta)$, are subtracted from each other. Further elementary manipulations lead to the desired estimate.

PROPOSITION.

$$\begin{aligned} &L(F_g(s_g(\cdot), \cdot)|F_{g,1+w}(A(\beta))) \leq \\ &L(s_g) \cdot [\mu(1 - \frac{a}{\mu}(1 - e^{-\mu})) + \max\{b, a + \epsilon\}] + 1 + L_\beta(g). \end{aligned}$$

The proof uses the triangle inequality, the preceding proposition, and arguments as in the proof of the estimate of $L(F_{g,w}|F_{g,1}(A(\beta)))$.

Notice that $L(F_g(s_g(\cdot), \cdot) | \dots)$ is bounded in terms of $L_\beta(g)$ and constants for β, ϵ small. So this term does not become large for suitable $g \in N(\beta, \epsilon)$.

The resulting estimate for the Lipschitz constant of the return map is

$$L(R_g) \leq L_\beta(g) (1 + w L(g)) L(F_g(s_g(\cdot), \cdot) | F_{g,1+w}(A(\beta))).$$

A consequence is that there exist $g \in N(\beta, \epsilon)$ so that R_g is a contraction. Examples are found as follows. First fix β and ϵ so that the smallness hypothesis for the previous estimate of $L(R_g)$ holds for all $g \in N(\beta, \epsilon)$. Then choose a Lipschitz continuous odd function $g : [-\beta, \beta] \rightarrow [-b, b]$ which satisfies $-a - \epsilon < g(\beta) < -a + \epsilon$. Continue this function to an odd map on \mathbb{R} with values in $(-a - \epsilon, -a + \epsilon)$ on (β, ∞) and $L_\beta(g)$ so small that the bound for $L(R_g)$ is less than 1.

Remarks. The small constant $L_\beta(g)$ compensates diverging solution behaviour allowed by the factor $1 + w L(g)$, on the way of flowlines back to $-A(\beta)$. The nonlinearities g for which R_g is a contraction are not necessarily constant on any interval, not necessarily monotone, may not have limits at infinity, and may not be differentiable everywhere. The negative feedback condition may be violated in $(-\beta, \beta)$. The orbits of the periodic solutions obtained from the fixed points of the contracting return maps attract all flowlines starting in $A(\beta)$; one can show that in case g is continuously differentiable the periodic orbits are hyperbolic and stable.

A disadvantage of the previous Lipschitz estimate of $L(R_g)$ is that it is not easy to verify for *given* analytic nonlinearities, which are steep close to 0 and flat away from 0, and which arise in applications, like, e.g., the function

$$g = -\tanh(\gamma \cdot), \quad \gamma > 0 \text{ large,}$$

used in neural network theory. In [244] the approach described above is refined for nonlinearities $g \in N(\beta, \epsilon)$ which are *monotone close to 0*. This involves sharp estimates of the divergent behaviour of flowlines one time unit after the underlying solutions traverse the interval $[-\beta, \beta]$ where g is monotone and steep. The improved Lipschitz estimates yield contracting return maps (and hyperbolic stable periodic orbits) for the scaled hyperbolic tangens above, for

$$g = -\arctan(\gamma \cdot), \quad \gamma > 0 \text{ large,}$$

and for other nonlinearities.

The sharpened estimates are obtained as follows. Let $g \in N(\beta, \epsilon)$ be given. The tongue containing $x^{\phi, g}$, $\phi \in A(\beta)$, on $[0, 1]$ is formed by the solutions $y_> = y_{>, \beta, \epsilon}$ and $y_< = y_{<, \beta, \epsilon}$ of the IVPs

$$\dot{y} = -\mu y - a \pm \epsilon, y(0) = \beta.$$

Define $w = w(\beta, \epsilon)$ to be the argument where $y_>$ reaches the level $y = -\beta$. For β not too large,

$$0 < w < 1.$$

Obviously,

$$x^{\phi, g}(t) \leq -\beta \text{ on } [w, 1].$$

Let $z_< = z_{<, \beta, \epsilon}$ and $z_> = z_{>, \beta, \epsilon}$ denote the zeros of $y_<$ and $y_>$, respectively, and let

$$\beta_- = \beta_{-, \beta, \epsilon} = y_<(w) < -\beta.$$

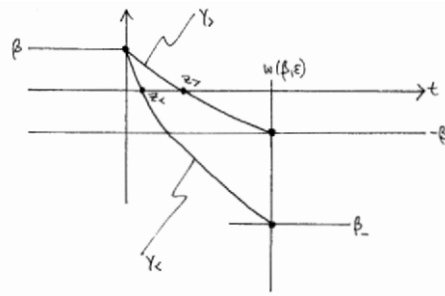

Figure 10.35.

For β and ϵ small and $g \in N(\beta, \epsilon)$ consider the return map $R_g : A(\beta) \rightarrow A(\beta)$ and decompose it as before. The objective is to find a better estimate for the middle composite $F_{g,w}|F_{g,1}(A(\beta))$. Recall that a Lipschitz continuous function $g \in N(\beta, \epsilon)$ is almost everywhere differentiable. We need the hypothesis that there is a set $D \subset \mathbb{R}$ whose complement has Lebesgue measure 0, with

$$g'(\xi) < 0 \text{ on } D \cap (\beta_-, \beta),$$

g' decreasing on $D \cap (\beta_-, 0)$ and increasing on $D \cap (0, \beta)$.

PROPOSITION.

$$L(F_{g,w}|...) \leq 4 + L(g) \frac{1}{\mu} \log \frac{(a + \epsilon)(\mu\beta + a - \epsilon)}{(a - \epsilon)(\mu\beta + a + \epsilon)}.$$

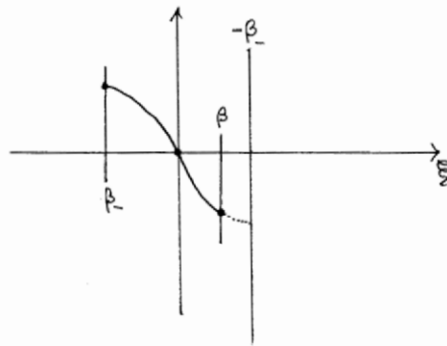

Figure 10.36.

Remark. The factors following $L(g)$ replace the *constant* w in the former estimate of $L(F_{g,w}|\dots)$. Notice that they vanish for $\epsilon = 0$! This indicates that $L(F_{g,w}|\dots)$ may not be too large even if $L(g)$ is large, for β and ϵ small.

The proof of the proposition begins with the extension of g' to a function on (β_-, β) which is decreasing on $(\beta_-, 0)$ and increasing on $(0, \beta)$. Let ϕ and ψ in $F_{g,1}(A(\beta))$ be given. For $-1 \leq t \leq 0$ and $0 < w + t$,

$$\begin{aligned} (F_{g,w}(\phi) - F_{g,w}(\psi))(t) &= x_w^{\phi,g}(t) - x_w^{\psi,g}(t) = \\ (\phi(0) - \psi(0))e^{-\mu(w+t)} &+ \int_0^{w+t} e^{-\mu(w+t-s)}(g(\phi(s-1)) - g(\psi(s-1)))ds, \\ |\dots| \leq \|\phi - \psi\| &+ \int_0^w |g(\phi(s-1)) - g(\psi(s-1))|ds. \end{aligned}$$

In the last integral we have $\phi = x_1$ and $\psi = z_1$ with solutions $x : [-1, \infty) \rightarrow \mathbb{R}$ and $z : [-1, \infty) \rightarrow \mathbb{R}$ which start in $A(\beta)$,

$$\int_0^w |\dots|ds = \int_0^w |g(x(s)) - g(z(s))|ds.$$

In order to estimate the integrand, consider the interval I_s with endpoints $x(s)$ and $z(s)$, $0 \leq s \leq w$. Obviously,

$$\begin{aligned} |g(x(s)) - g(z(s))| &= \left| \int_{I_s} g' \right| \\ &\leq \sup_{I_s} |g'| \cdot |x(s) - z(s)| \leq \sup \dots \|\phi - \psi\| \end{aligned}$$

and

$$\beta_- \leq y_<(s) \leq \min\{x(s), z(s)\} \leq \max\{x(s), z(s)\} \leq y_>(s) \leq \beta,$$

or

$$I_s \subset [y_<(s), y_>(s)] \subset [\beta_-, \beta].$$

The last relation shows that in case $0 < y_<(s)$ (i.e., $s < z_<$) the monotonicity property of g' is applicable. We find

$$\sup_{I_s} |g'| \leq -g'(y_<(s)).$$

In case $0 \in I_s$,

$$\sup_{I_s} |g'| = -g'(0).$$

In case $y_>(s) < 0$ (i.e., $z_> < s$),

$$\sup_{I_s} |g'| \leq -g'(y_>(s)).$$

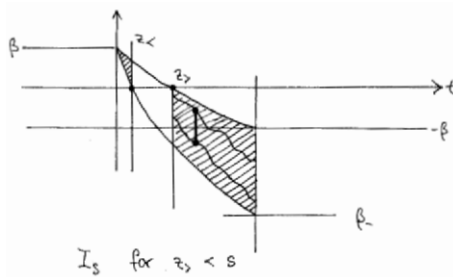

Figure 10.37.

Now the last integrals can be estimated as follows. We have

$$\int_0^w |\dots| \leq \|\phi - \psi\| \cdot \left(\int_0^{z_<} |g' \circ y_<| + |g'(0)| \int_{z_<}^{z_>} 1 + \int_{z_>}^w |g' \circ y_>| \right).$$

The substitution $s = y_<^{-1}(\xi)$ in the first integral leads to the upper bound 1 for this integral. The substitution $s = y_>^{-1}(\xi)$ in the third integral leads to the upper bound 2 for it. The endpoints $z_<$ and $z_>$ of the range in the second integral can be computed as functions of β, ϵ, μ, a .

In the remaining case $w + t \leq 0$, clearly

$$|(F_{g,w}(\phi) - F_{g,w}(\psi))(t)| = |x_w^{\phi,g}(t) - x_w^{\psi,g}(t)| = |\phi(w+t) - \psi(w+t)| \leq \|\phi - \psi\|.$$

Remark. It can be shown that the Lipschitz estimate of the proposition is optimal in the limit $(\beta, \epsilon) \rightarrow (0, 0)$.

Continuing as in [243] one finds that for (β, ϵ) small and $g \in N(\beta, \epsilon)$,

$$L(R_g) \leq L_\beta(g) \left[4 + L(g) \beta \epsilon \frac{3\mu}{a^2} \right] \cdot \left[\frac{1 + e^\mu L_\beta(g)}{a - \epsilon - \mu \beta e^\mu} \cdot \left[\mu \left(1 - \frac{a}{\mu} (1 - e^{-\mu}) \right) + \max\{b, a + \epsilon\} \right] + 1 + L_\beta(g) \right].$$

The middle factor comes from the estimate of the middle composite $F_{g,w}| \dots$. Recall that for suitable $g \in N(\beta, \epsilon)$, $L_\beta(g)$ is small.

How can one verify for *given* nonlinearities g that the upper bound for $L(R_g)$ is less than 1? Let $\mu > 0$ and an odd bounded Lipschitz continuous function $g : \mathbb{R} \rightarrow \mathbb{R}$ be given so that g' is negative and increasing on the complement of a set of measure 0 in $[0, \infty)$. Then g has a limit $-a \leq 0$ at $+\infty$. Suppose $a > 0$, and consider the family of functions

$$g_\gamma = g(\gamma \cdot), \gamma > 0.$$

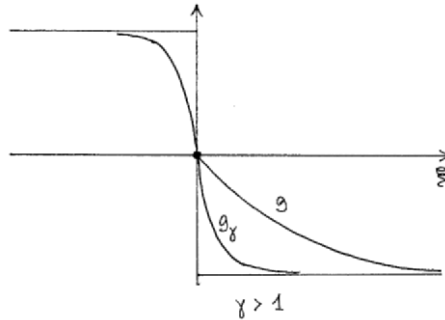

Figure 10.38.

How can $\beta = \beta(\gamma)$ and $\epsilon = \epsilon(\gamma)$ be chosen so that $g_\gamma \in N(\beta, \epsilon)$ and $L(R_{g_\gamma}) < 1$, at least for large γ ? We have $L_\beta(g_\gamma) = \gamma L_{\gamma\beta}(g)$.

PROPOSITION. Suppose there exists a function

$$\beta_* : (0, \infty) \rightarrow (0, \infty)$$

so that for $\gamma \rightarrow \infty$,

$$\beta_*(\gamma) \rightarrow 0,$$

$$\begin{aligned} \gamma \beta_*(\gamma) &\rightarrow \infty, \\ \gamma L_{\gamma\beta_*(\gamma)}(g) &\rightarrow 0, \\ \gamma L_{\gamma\beta_*(\gamma)}(g) \gamma \beta_*(\gamma) [a + g(\gamma \beta_*(\gamma))] &\rightarrow 0. \end{aligned}$$

Then there exists $\gamma_* > 0$ so that for all $\gamma > \gamma_*$, R_{g_γ} is a contraction.

In order to prove this one sets $b = 2a$. For every $\gamma > 0$, $\beta > 0$, and $\epsilon = a + g(\gamma\beta)$, we have

$$g_\gamma \in N(\beta, \epsilon).$$

The function g_γ is Lipschitz continuous and satisfies the monotonicity hypothesis required for the last proposition. Then the estimate of $L(R_{g_\gamma})$ has to be used.

Examples. Consider $\mu > 0$ and g as before. Suppose in addition that for some $r > \frac{3}{2}$,

$$D \cap (0, \infty) \ni \xi \mapsto |\xi^r g'(\xi)| \quad \text{is bounded.}$$

Choose $s \in (-1, 0)$ with $\frac{1}{1+s} < r$ and $1 + \frac{1}{2+2s} < r$. Then the map

$$\beta_* : \gamma \mapsto \gamma^s$$

satisfies the hypotheses of the last proposition.

Special cases are given by $g = -\tanh$, $g = -\arctan$.

Remarks. A somewhat stronger result for one-parameter-families of nonlinearities g_γ which are at least continuously differentiable was obtained earlier by Xie [255]. He proved that for γ large the orbits of *given* periodic solutions are hyperbolic and stable. The proof is a study of the leading Floquet multipliers and relies on very careful a-priori estimates of periodic solutions. The hypotheses needed in [255] are that the smooth function g has limits at infinity, that g' is Lebesgue integrable, and that $\xi g'(\xi) \rightarrow 0$ as $|\xi| \rightarrow \infty$. I.e., no monotonicity properties of g' are required, and the behaviour of g' at infinity is less restricted than in the examples mentioned above.

In the approach described here the condition that the nonlinearities g are odd is not essential. Variants of the method have also been applied to *systems* of delay differential equations [246, 96] and to an equation with state-dependent delay [245]. For the latter, no other method to obtain *stable* periodic motion seems presently available.

5. State-dependent delays

Differential equations with state-dependent delay can often be written in the form

$$\dot{x}(t) = f(x_t) \quad (5.1)$$

with a continuously differentiable map $f : C^1 \supset U \rightarrow \mathbb{R}^n$, U open. The associated IVP is not well-posed on U , however. Continuous flowlines may in general only be expected for data in the subset

$$X = X_f = \{\phi \in U : \dot{\phi}(0) = f(\phi)\} \subset C^1.$$

Notice that X is a nonlinear version of the positively invariant domain

$$\{\phi \in C^1 : \dot{\phi}(0) = L\phi\}$$

of the generator G of the semigroup defined by the linear autonomous RFDE

$$\dot{y}(t) = Ly_t$$

on the larger space C , for $L : C \rightarrow \mathbb{R}^n$ linear continuous. Notice also that in case of a locally Lipschitz continuous map $f_* : U_* \rightarrow \mathbb{R}^n$, $U_* \subset C$ open, all solutions $x : [-h, b) \rightarrow \mathbb{R}^n$, $h < b$, of the RFDE

$$\dot{x}(t) = f_*(x_t)$$

satisfy

$$x_t \in X_{f_*} = \{\phi \in U_* \cap C^1 : \dot{\phi}(0) = f_*(\phi)\} \text{ for } h \leq t < b.$$

I.e., the set X_{f_*} absorbs all flowlines on intervals $[-h, b)$ which are long enough. In particular, X_{f_*} contains all segments of solutions on intervals $(-\infty, b)$, $b \leq \infty$ - equilibria, periodic orbits, local unstable manifolds, and the global attractor if the latter is present.

In order to have a semiflow on X with differentiability properties we need that X is smooth. This requires an additional condition on f .

PROPOSITION. Suppose $X \neq \emptyset$ and

(P1) each derivative $Df(\phi)$, $\phi \in U$, has a continuous linear extension

$$D_e f(\phi) : C \rightarrow \mathbb{R}^n.$$

Then X is a continuously differentiable submanifold of C^1 with codimension n .

The proof is easy. Consider the continuous linear map

$$p : C^1 \ni \phi \mapsto \dot{\phi}(0) \in \mathbb{R}^n.$$

Then

$$X = (p - f)^{-1}(0).$$

It is enough to show that all derivatives $D(p - f)(\phi)$, $\phi \in X$, are surjective.

Proof of this for $n = 1$: By (P1), for some $\delta > 0$,

$$D_e f(\phi)C_\delta \subset (-1, 1).$$

There exists $\chi \in C^1 \cap C_\delta$ with $\dot{\chi}(0) = 1$. Hence

$$0 < \dot{\chi}(0) - Df(\phi)\chi = D(p - f)(\phi)\chi,$$

$$\mathbb{R} \subset D(p - f)(\phi)C^1.$$

(The Implicit Function Theorem then yields that close to ϕ the set X is given by a map from a subset of the nullspace N of $D(p - f)(\phi)$ into a complement of N in C^1 .)

A solution of eq. (5.1) is defined to be a *continuously differentiable* map $x : [t_0 - h, t_e) \rightarrow \mathbb{R}^n$, with $t_0 \in \mathbb{R}$ and $t_0 < t_e \leq \infty$, so that for $t_0 \leq t < t_e$, $x_t \in U$, and eq. (5.1) is satisfied. We also consider solutions on unbounded intervals $(-\infty, t_e)$. Maximal solutions of IVPs are defined as in part I.

THEOREM. Suppose (P1) holds, $X \neq \emptyset$, and (P2) for each $\phi \in U$ there exist a neighbourhood V (in C^1) and $L \geq 0$ so that

$$|f(\psi) - f(\chi)| \leq L\|\psi - \chi\| \text{ for all } \psi \in V, \chi \in V.$$

Then the maximal solutions $x^\phi : [-h, t_e(\phi)) \rightarrow \mathbb{R}^n$ of eq. (5.1) which start at points $\phi \in X$ define a continuous semiflow

$$F : \Omega \ni (t, \phi) \mapsto x_t^\phi \in X, \quad \Omega = \bigcup_{\phi \in X} [0, t_e(\phi)) \times \{\phi\},$$

and all solution maps

$$F_t : \Omega_t \ni \phi \mapsto F(t, \phi) \in X, \quad \emptyset \neq \Omega_t = \{\phi \in X : (t, \phi) \in \Omega\},$$

are continuously differentiable. For all $\phi \in X$, $t \in [0, t_e(\phi))$, and $\chi \in T_\phi X$,

$$DF_t(\phi)\chi = v_t^{\phi, \chi}$$

with a continuously differentiable solution $v^{\phi, \chi} : [-h, t_e(\phi)) \rightarrow \mathbb{R}^n$ of the IVP

$$\dot{v}(t) = Df(F_t(\phi))v_t,$$

$$v_0 = \chi.$$

Comments.

- Notice that the Lipschitz estimate in (P2) involves the smaller norm $\|\cdot\| \leq \|\cdot\|_1$ on the larger space $C \supset C^1$. Property (P2) was used in [245] in a proof that for certain differential equations with state-dependent delay stable periodic orbits exist. It is closely related to the earlier idea of being *locally almost Lipschitzian* in work of Mallet-Paret, Nussbaum, and Paraskevopoulos [175].
- Property (P1) is a special case of a condition used in Krisztin's work on smooth unstable manifolds [132]. Almost the same property occurred earlier [175], under the name *almost Frechet differentiability*.
- Louihi, Hbid, and Arino [164] identified the set X as the domain of a generator in the context of nonlinear semigroup theory, for a class of differential equations with state-dependent delay. It is mentioned in [164] that X is a Lipschitz manifold. In [139] a complete metric space analogous to X serves as a state space for neutral functional differential equations.
- Former results about solutions close to an equilibrium, like the principle of linearized stability for differential equations with state-dependent delay due to Cooke and Huang [48], or results on local unstable manifolds [131, 132], had to be proven without knowledge of linearizations at the equilibrium. The difficulty was circumvented by means of an associated linear autonomous RFDE (a) on the large space C . Eq. (a) is obtained heuristically, for certain classes of differential equations with state-dependent delay: First the delays are frozen at the given equilibrium ϕ , then the resulting RFDE with constant delays is linearized. Examples show how eq. (a) is related to the actual variational equation

$$\dot{v}(t) = Df(\phi)v_t$$

for data in $T_\phi X \subset C^1$: Eq. (a) is simply

$$\dot{v}(t) = D_e f(\phi)v_t.$$

Also, for the semigroup $(T(t))_{t \geq 0}$ on C associated with the last RFDE and for its generator G ,

$$T_\phi X = \text{dom}(G)$$

and

$$DF_t(\phi)\chi = T(t)\chi \quad \text{on} \quad T_\phi X.$$

- The theorem yields continuously differentiable local invariant manifolds

$$W_u, W_c, W_s$$

of the solution maps F_t at fixed points; in particular, at stationary points ϕ of the semiflow. In the last case the tangent spaces of the local invariant manifolds at ϕ are the unstable, center, and restricted stable spaces

$$C^u, C^c, \quad \text{and} \quad C^s \cap T_\phi X$$

of the generator G , respectively. At a stationary point ϕ the local unstable and stable manifolds W_u, W_s coincide with local unstable and stable manifolds W^u, W^s of the semiflow F . An analogous result for - suitable - center manifolds seems unknown.

- Local unstable manifolds at stationary points of differential equations with state-dependent delay were found earlier by H. Krishnan [131] and T. Krisztin [132], under the hypothesis that the associated linear autonomous RFDE (a) is hyperbolic. Hyperbolicity is also necessary for a recent result of Arino and Sanchez [16] which captures saddle point behaviour of solutions close to equilibrium for a class of differential equations with state-dependent delay.

The essential part of the proof of our theorem is to solve the equation

$$x(t) = \phi(0) + \int_0^t f(x_s) ds, \quad 0 \leq t \leq T,$$

$$x_0 = \phi \in X,$$

by a continuously differentiable map

$$x : [-h, T] \rightarrow R^n,$$

for $\phi \in X$ given; x should also be continuously differentiable with respect to ϕ . Is the Contraction Mapping Principle with parameters applicable? How does the operator given by the fixed point equation depend on ϕ ? We first rewrite the fixed point equation so that the dependence of the

integral on ϕ becomes explicit. For $\phi \in C^1$ let $\hat{\phi}$ denote the continuously differentiable extension to $[-h, T]$ given by

$$\hat{\phi}(t) = \phi(0) + \dot{\phi}(0)t \text{ on } [0, T].$$

Set $u = x - \hat{\phi}$. Then u belongs to the Banach space C^1_{0T} of continuously differentiable maps $y : [-h, T] \rightarrow \mathbb{R}^n$ with

$$y(t) = 0 \text{ on } [-h, 0];$$

the norm on C^1_{0T} is given by

$$\|y\|_{C^1_{0T}} = \max_{-h \leq t \leq T} |y(t)| + \max_{-h \leq t \leq T} |\dot{y}(t)|.$$

u and $\hat{\phi}$ satisfy

$$u(t) + \hat{\phi}(t) = \phi(0) + \int_0^t f(u_s + \hat{\phi}_s) ds$$

and

$$\hat{\phi}(t) = \phi(0) + \dot{\phi}(0)t = \phi(0) + t f(\phi)$$

(since $\phi \in X$)

$$= \phi(0) + \int_0^t f(\phi) ds.$$

For $u \in C^1_{0T}$ this yields the fixed point equation

$$u(t) = \int_0^t (f(u_s + \hat{\phi}_s) - f(\phi)) ds, \quad 0 \leq t \leq T,$$

with parameter $\phi \in X$.

Now let some $\phi_0 \in X$ be given. For $\phi \in X$ close to ϕ_0 , $u \in C^1_{0T}$ small, and $0 \leq t \leq T$ with $T > 0$ small, define

$$A(\phi, u)(t)$$

by the right hand side of the last equation. The property (P2) is used to show that the maps $A(\phi, \cdot)$ are contractions with respect to the norm on C^1_{0T} , with a contraction factor independent of ϕ : Let $v = A(\phi, u), \bar{v} = A(\phi, \bar{u})$. For $0 \leq t \leq T$,

$$|\dot{v}(t) - \dot{\bar{v}}(t)| = |f(u_t + \hat{\phi}_t) - f(\bar{u}_t + \hat{\phi}_t)| \leq L \|u_t - \bar{u}_t\|$$

(due to (P2); L may be large!)

$$\leq L \max_{0 \leq s \leq T} |u(s) - \bar{u}(s)|.$$

We exploit the fact that the last term does not contain derivatives: For $0 \leq s \leq T$,

$$|u(s) - \bar{u}(s)| = |0 - 0 + \int_0^s (\dot{u}(r) - \dot{\bar{u}}(r))dr| \leq T \|u - \bar{u}\|_{C^1_{0T}}.$$

Hence

$$|\dot{v}(t) - \dot{\bar{v}}(t)| \leq LT \|u - \bar{u}\|_{C^1_{0T}}.$$

Also,

$$\begin{aligned} |v(t) - \bar{v}(t)| &= \left| \int_0^t (f(u_s + \hat{\phi}_s) - f(\bar{u}_s + \hat{\phi}_s))ds \right| \leq LT \max_{0 \leq s \leq t} \|u_s - \bar{u}_s\| \\ &\leq LT \|u - \bar{u}\|_{C^1_{0T}}. \end{aligned}$$

(Property (P2) is not necessary here. Alternatively the local Lipschitz continuity of f with respect to the norm on C^1 can be used to find a suitable upper estimate.)

For $2LT < 1$ the map $A(\phi, \cdot)$ becomes a contraction. One finds a closed ball which is mapped into itself by each map $A(\phi, \cdot)$. The formula defining A shows that A is continuously differentiable. It follows that for each ϕ the ball contains a fixed point u_ϕ of $A(\phi, \cdot)$ which is continuously differentiable with respect to ϕ . This completes the essential step in the proof of the theorem.

We give an example which is based on elementary physics. Consider an object on a line which attempts to regulate its position $x(t)$ by echo. The object emits a signal which is then reflected by an obstacle. The reflected signal is detected and the signal running time is measured. From this a position is computed (which is not necessarily the true position). The computed position is followed by an acceleration towards a preferred position (e.g., an equilibrium position in a certain distance from the obstacle).

Let $c > 0$ denote the speed of the signals, $-w < 0$ the position of the obstacle, and $\mu > 0$ a friction constant. The acceleration is given by a function $a : \mathbb{R} \rightarrow \mathbb{R}$; one may think of negative feedback:

$$a(0) = 0 \text{ and } \xi a(\xi) < 0 \text{ for } \xi \neq 0.$$

Let $x(t)$ denote the position of the object at time t , $v(t)$ its velocity, $p(t)$ the computed position, and $s(t)$ the running time of the signal which has

been emitted at time $t - s(t)$ and whose reflection is detected at time t . The model equations then are

$$\begin{aligned}\dot{x}(t) &= v(t) \\ \dot{v}(t) &= -\mu v(t) + a(p(t)) \\ p(t) &= \frac{c}{2}s(t) - w \\ c s(t) &= x(t - s(t)) + x(t) + 2w\end{aligned}$$

Here only solutions with

$$-w < x(t)$$

are considered. The formula defining $p(t)$ yields the true position if

$$x(t) = x(t - s(t)),$$

which holds at least at equilibria.

Let $w_+ > 0$. Restrict attention further to bounded solutions with

$$-w < x(t) < w_+ \quad \text{and} \quad |\dot{x}(t)| < c.$$

Then necessarily

$$0 < s(t) \leq \frac{2w + 2w_+}{c} = h.$$

The model has not yet the form (3) considered in the theorem. In order to reformulate the model, take h as just defined, consider the space

$$C^1 = C^1([-h, 0], \mathbb{R}^2),$$

and the open convex subset

$$U = \{\phi = (\phi_1, \phi_2) \in C^1 : -w < \phi_1(t) < w_+, |\dot{\phi}_1(t)| < c \text{ for } -h \leq t \leq 0\}.$$

Each $\phi \in U$ determines a unique solution $s = \sigma(\phi)$ of

$$s = \frac{1}{c}(\phi_1(-s) + \phi_1(0) + 2w),$$

as the right hand side of this fixed point equation defines a contraction on $[0, h]$. The Implicit Function Theorem shows that the resulting map

$$\sigma : U \rightarrow [0, h]$$

is continuously differentiable. Elementary estimates imply that it is also Lipschitz continuous with respect to the norm on $C = C([-h, 0], \mathbb{R}^2)$.

I.e., an analogue of property (P2) holds.

Assume the response function $a : \mathbb{R} \rightarrow \mathbb{R}$ is continuously differentiable. Then the map

$$f : U \rightarrow \mathbb{R}^2$$

given by

$$f_1(\phi) = \phi_2(0),$$

and

$$f_2(\phi) = -\mu\phi_2(0) + a\left(\frac{c}{2}\sigma(\phi) - w\right) = -\mu\phi_2(0) + a\left(\frac{\phi_1(-\sigma(\phi)) + \phi_1(0)}{2}\right)$$

is continuously differentiable and has property (P2), and for bounded solutions as above the model can be rewritten in the form of eq. (5.1).

Verification of property (P1). For each $\phi \in U$ and all $\chi \in C^1$,

$$D\sigma(\phi)\chi = \frac{Ev_1(\chi_1, -\sigma(\phi)) + Ev_1(\chi_1, 0)}{Ev_1(\dot{\phi}_1, -\sigma(\phi)) - c} = \frac{\chi_1(-\sigma(\phi)) + \chi_1(0)}{\dot{\phi}_1(-\sigma(\phi)) - c},$$

with the evaluation map

$$Ev_1 : C^1([-h, 0], \mathbb{R}) \times [-h, 0] \ni (\psi, t) \mapsto \psi(t) \in \mathbb{R}.$$

Each $Ev_1(\cdot, t)$, $t \in [-h, 0]$, is the restriction of a continuous linear evaluation functional on the space $C([-h, 0], \mathbb{R})$. It follows that $D\sigma(\phi) : C^1 \rightarrow \mathbb{R}$ has a continuous linear extension $D_e\sigma(\phi) : C \rightarrow \mathbb{R}$. The formula

$$Df_2(\phi)\chi = -\mu Ev_1(\chi_2, 0) + Da\left(\frac{c}{2}\sigma(\phi) - w\right)\frac{c}{2}D\sigma(\phi)\chi$$

finally shows that f has property (P1).

Suppose

$$a(0) = 0.$$

Then $\phi = 0$ is a stationary point, and

$$\sigma(0) = \frac{2w}{c}.$$

The previous calculations show that the variational equation from the theorem is the system

$$\begin{aligned} v_1(t) &= v_2(t) \\ v_2(t) &= -\mu v_2(t) + a'(0)\frac{v_1(t - 2w/c) + v_1(t)}{2}. \end{aligned}$$

Notice that the heuristic approach (freeze the delay, then linearize) yields the very same system.

Back to general results. The semiflow F from the theorem is continuously differentiable for $t > h$ provided f satisfies (P1) and the condition that

(P1*) the map $U \times C \ni (\phi, \chi) \mapsto D_e f(\phi)\chi \in \mathbb{R}^n$ is continuous.

Remarks.

- Notice that continuous differentiability of the semiflow (for $t > h$) is needed in order to have Poincaré return maps for periodic orbits, among others.
- (P1) and (P1*) imply (P2).
- (P1*) holds for the example.
- The stronger condition that the map

$$U \ni \phi \mapsto D_e f(\phi) \in L(C, \mathbb{R}^n)$$

be continuous is *not* satisfied by the example.

The solution maps F_t are compact for $t \geq h$ under certain other hypotheses on f . The latter are satisfied by the example for suitable functions a .

Further work, Open Problems.

- For continuously differentiable center manifolds of the semiflow, see the forthcoming survey article [107] and [134]. A first Hopf bifurcation theorem for differential equations with state-dependent delay is due to M. Eichmann [62].
- Can the approach be generalized so that one obtains higher order derivatives for semiflows given by differential equations with state-dependent delay?
- For suitable parameters *stable* periodic motion far away from equilibrium was established in [248].
- A related but in several respects more complicated problem is the description of the motion of two charged particles, which was initiated by R.D. Driver [61].

Chapter 11

DELAY DIFFERENTIAL EQUATIONS IN SINGLE SPECIES DYNAMICS

S. Ruan*

Department of Mathematics

University of Miami

PO Box 249085

Coral Gables, FL 33124-4250

USA

ruan@math.miami.edu

1. Introduction

Time delays of one type or another have been incorporated into biological models to represent resource regeneration times, maturation periods, feeding times, reaction times, etc. by many researchers. We refer to the monographs of Cushing (1977a), Gopalsamy (1992), Kuang (1993) and MacDonald (1978) for discussions of general delayed biological systems. In general, delay differential equations exhibit much more complicated dynamics than ordinary differential equations since a time delay could cause a stable equilibrium to become unstable and cause the populations to fluctuate. In this survey, we shall review various delay differential equations models arising from studying single species dynamics.

Let $x(t)$ denote the population size at time t ; let b and d denote the birth rate and death rate, respectively, on the time interval $[t, t + \Delta t]$, where $\Delta t > 0$. Then

$$x(t + \Delta t) - x(t) = bx(t)\Delta t - dx(t)\Delta t.$$

Dividing by Δt and letting Δt approach zero, we obtain

*Research was partially supported by NSF grant DMS-0412047 and a Small Grant Award from the University of Miami.

$$\frac{dx}{dt} = bx - dx = rx, \quad (1.1)$$

where $r = b - d$ is the intrinsic growth rate of the population. The solution of equation (1.1) with an initial population $x(0) = x_0$ is given by

$$x(t) = x_0 e^{rt}. \quad (1.2)$$

The function (1.2) represents the traditional exponential growth if $r > 0$ or decay if $r < 0$ of a population. Such a population growth, due to Malthus (1798), may be valid for a short period, but it cannot go on forever. Taking the fact that resources are limited into account, Verhulst (1836) proposed the logistic equation

$$\frac{dx}{dt} = rx \left(1 - \frac{x}{K} \right), \quad (1.3)$$

where $r(> 0)$ is the *intrinsic growth rate* and $K(> 0)$ is the *carrying capacity* of the population. In model (1.3), when x is small the population grows as in the Malthusian model (1.1); when x is large the members of the species compete with each other for the limited resources. Solving (1.3) by separating the variables, we obtain ($x(0) = x_0$)

$$x(t) = \frac{x_0 K}{x_0 - (x_0 - K)e^{-rt}}. \quad (1.4)$$

If $x_0 < K$, the population grows, approaching K asymptotically as $t \rightarrow \infty$. If $x_0 > K$, the population decreases, again approaching K asymptotically as $t \rightarrow \infty$. If $x_0 = K$, the population remains in time at $x = K$. In fact, $x = K$ is called an *equilibrium* of equation (1.3). Thus, the positive equilibrium $x = K$ of the logistic equation (1.3) is globally stable; that is, $\lim_{t \rightarrow \infty} x(t) = K$ for solution $x(t)$ of (1.3) with any initial value $x(0) = x_0$.

2. Hutchinson's Equation

In the above logistic model it is assumed that the growth rate of a population at any time t depends on the relative number of individuals at that time. In practice, the process of reproduction is not instantaneous. For example, in *Daphnia* a large clutch presumably is determined not by the concentration of unconsumed food available when the eggs hatch, but by the amount of food available when the eggs were forming, some time before they pass into the brood pouch. Between this time of determination and the time of hatching many newly hatched animals may have been liberated from the brood pouches of other *Daphnia* in

the culture, so increasing the population. In fact, in an extreme case all the vacant spaces $K - x$ might have been filled well before reproduction stops. Hutchinson (1948) assumed egg formation to occur τ units of time before hatching and proposed the following more realistic logistic equation

$$\frac{dx}{dt} = rx(t) \left[1 - \frac{x(t-\tau)}{K} \right], \quad (2.1)$$

where r and K have the same meaning as in the logistic equation (1.3), $\tau > 0$ is a constant. Equation (2.1) is often referred to as the *Hutchinson's equation* or *delayed logistic equation*.

2.1 Stability and Bifurcation

The initial value of equation (2.1) is given by

$$x(\theta) = \phi(\theta) > 0, \quad \theta \in [-\tau, 0],$$

where ϕ is continuous on $[-\tau, 0]$. An equilibrium $x = x^*$ of (2.1) is *stable* if for any given $\epsilon > 0$ there is a $\delta > 0$ such that $|\phi(t) - x^*| \leq \delta$ on $[-\tau, 0]$ implies that all solutions $x(t)$ of (2.1) with initial value ϕ on $[-\tau, 0]$ satisfy $|x(t) - x^*| < \epsilon$ for all $t \geq 0$. If in addition there is a $\delta_0 > 0$ such that $|\phi(t) - x^*| \leq \delta_0$ on $[-\tau, 0]$ implies $\lim_{t \rightarrow \infty} x(t) = x^*$, then x^* is called *asymptotically stable*.

Notice that equation (2.1) has equilibria $x = 0$ and $x = K$. Small perturbations from $x = 0$ satisfy the linear equation $\frac{dx}{dt} = rx$, which shows that $x = 0$ is unstable with exponential growth. We thus only need to consider the stability of the positive equilibrium $x = K$. Let $X = x - K$. Then,

$$\frac{dX}{dt} = -rX(t-\tau) - \frac{r}{K}X(t)X(t-\tau).$$

Thus, the linearized equation is

$$\frac{dX}{dt} = -rX(t-\tau). \quad (2.2)$$

We look for solutions of the form $X(t) = ce^{\lambda t}$, where c is a constant and the eigenvalues λ are solutions of the characteristic equation

$$\lambda + re^{-\lambda\tau} = 0, \quad (2.3)$$

which is a transcendental equation. By the linearization theory, $x = K$ is asymptotically stable if all eigenvalues of (2.3) have negative real parts.

Set $\lambda = \mu + i\nu$. Separating the real and imaginary parts of the characteristic equation (2.3), we obtain

$$\begin{aligned}\mu + re^{-\mu\tau} \cos \nu\tau &= 0, \\ \nu - re^{-\mu\tau} \sin \nu\tau &= 0.\end{aligned}\tag{2.4}$$

Notice that when $\tau = 0$, the characteristic equation (2.3) becomes $\lambda + r = 0$ and the eigenvalue $\lambda = -r < 0$ is a negative real number. We seek conditions on τ such that $\operatorname{Re}\lambda$ changes from negative to positive. By the continuity, if λ changes from $-r$ to a value such that $\operatorname{Re}\lambda = \mu > 0$ when τ increases, there must be some value of τ , say τ_0 , at which $\operatorname{Re}\lambda(\tau_0) = \mu(\tau_0) = 0$. In other words, the characteristic equation (2.3) must have a pair of purely imaginary roots $\pm i\nu_0$, $\nu_0 = \nu(\tau_0)$. Suppose such is the case. Then we have

$$\cos \nu_0\tau = 0,$$

which implies that

$$\nu_0\tau_k = \frac{\pi}{2} + 2k\pi, \quad k = 0, 1, 2, \dots$$

Noting that $\nu_0 = r$, we have

$$\tau_k = \frac{\pi}{2r} + \frac{2k\pi}{r}, \quad k = 0, 1, 2, \dots$$

Therefore, when

$$\tau = \tau_0 = \frac{\pi}{2r},$$

equation (2.3) has a pair of purely imaginary roots $\pm ir$, which are simple and all other roots have negative real parts. When $0 < \tau < \frac{\pi}{2r}$, all roots of (2.3) have strictly negative real parts.

Denote $\lambda(\tau) = \mu(\tau) + i\nu(\tau)$ the root of equation (2.3) satisfying $\mu(\tau_k) = 0$, $\nu(\tau_k) = \nu_0$, $k = 0, 1, 2, \dots$. We have the transversality condition

$$\left. \frac{d\mu}{d\tau} \right|_{\tau=\tau_k} = r^2 > 0, \quad k = 0, 1, 2, \dots$$

We have just shown the following conclusions.

Theorem 1 (i) If $0 \leq r\tau < \frac{\pi}{2}$, then the positive equilibrium $x = K$ of equation (2.1) is asymptotically stable.

(ii) If $r\tau > \frac{\pi}{2}$, then $x = K$ is unstable.

(iii) When $r\tau = \frac{\pi}{2}$, a Hopf bifurcation occurs at $x = K$; that is, periodic solutions bifurcate from $x = K$. The periodic solutions exist for $r\tau > \frac{\pi}{2}$ and are stable.

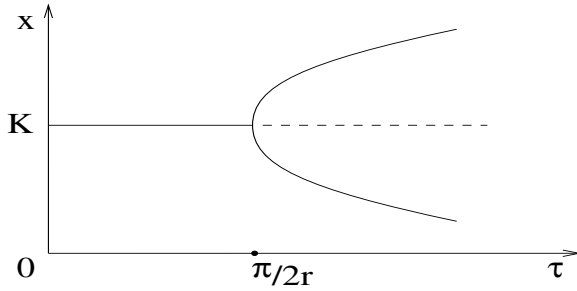

Figure 11.1. The bifurcation diagram for equation (2.1).

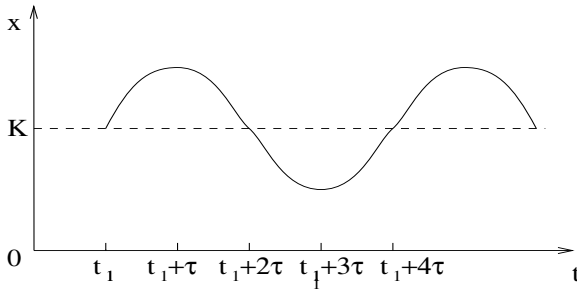

Figure 11.2. The periodic solution of the Hutchinson's equation (2.1).

The above theorem can be illustrated by Fig. 11.1, where the solid curves represent stability while the dashed lines indicate instability.

By (iii), the Hutchinson's equation (2.1) can have periodic solutions for a large range of values of $r\tau$, the product of the birth rate r and the delay τ . If T is the period then $x(t + T) = x(t)$ for all t . Roughly speaking, the stability of a periodic solution means that if a perturbation is imposed the solution returns to the original periodic solution as $t \rightarrow \infty$ with possibly a phase shift. The period of the solution at the critical delay value is $\frac{2\pi}{\nu_0}$ (Hassard et al. (1981)), thus, it is 4τ (see Fig. 11.2). Numerical simulations are given in Fig. 11.3.

2.2 Wright Conjecture

The Hutchinson's equation (2.1) can be written as

$$\frac{dy}{dt} = -ry(t - \tau)[1 + y(t)]$$

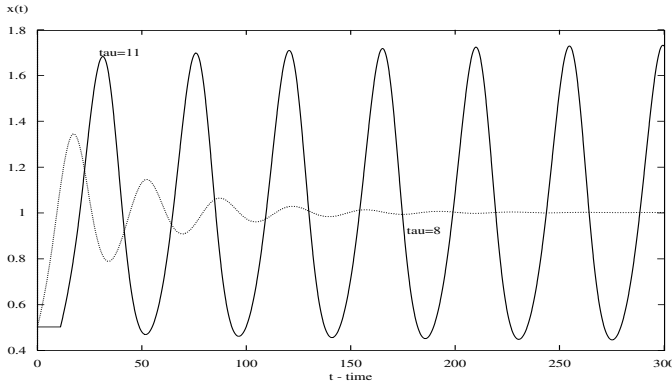

Figure 11.3. Numerical simulations for the Hutchinson’s equation (2.1). Here $r = 0.15, K = 1.00$. (i) When $\tau = 8$, the steady state $x^* = 1$ is stable; (ii) When $\tau = 11$, a periodic solution bifurcated from $x^* = 1$.

by assuming $y(t) = -1 + x(t)/K$. Letting $t = \tau\bar{t}$, $\bar{y}(\bar{t}) = y(\tau\bar{t})$, we have

$$\frac{d}{dt}\bar{y}(\bar{t}) = -r\tau\bar{y}(\bar{t} - 1)[1 + \bar{y}(\bar{t})].$$

Denoting $\alpha = r\tau$ and dropping the bars, we obtain

$$\frac{dy}{dt} = -\alpha y(t - 1)[1 + y(t)]. \tag{2.5}$$

By Theorem 1, we know that the zero solution of (2.5) is asymptotically stable if $\alpha < \pi/2$ and unstable if $\alpha > \pi/2$. Wright (1955) showed that the zero solution of (2.5) is globally stable if $\alpha < 3/2$. Wright then conjectured that the zero solution of (2.5) is globally stable if $\alpha < \pi/2$, which is still open.

Kakutani and Markus (1958) proved that all solutions of (2.5) oscillate if $\alpha > 1/e$ and do not oscillate if $\alpha < 1/e$. Jones (1962a, 1962b) studied the global existence of periodic solutions for $\alpha > \pi/2$. For further research on existence of non-constant periodic solutions, see Haderler and Tomiuk (1977), Hale and Verduyn Lunel (1993), Kaplan and York (1975), Naussbaum (1974), Walther (1975), etc. See also Kuang (1993) for further results and more references.

Recently, some attention has been paid to the study of equation (2.5) when $\alpha = \alpha(t)$ is a positive continuous function. For example, Sugie (1992) showed that the zero solution of (2.5) with $\alpha = \alpha(t)$ is uniformly stable if there is a constant $\alpha_0 > 0$ such that

$$\alpha(t) \leq \alpha_0 < \frac{3}{2} \text{ for all } t \geq 0. \tag{2.6}$$

Chen et al. (1995) improved condition (2.6) to the following:

$$\int_{t-1}^t \alpha(s)ds \leq \alpha_0 < \frac{3}{2} \text{ for } t \geq 1. \tag{2.7}$$

Stability conditions such as (2.6) and (2.7) are called $\frac{3}{2}$ -stability criteria. For further related work, we refer to Kuang (1993), Yu (1996) and the references therein.

2.3 Instantaneous Dominance

Consider a logistic equation with a discrete delay of the form

$$\frac{dx}{dt} = rx(t)[1 - a_1x(t) - a_2x(t - \tau)], \tag{2.8}$$

where a_1 and a_2 are positive constants. There is a positive equilibrium $x^* = \frac{1}{a_1+a_2}$, which is stable when there is no delay. Employing similar arguments, one can prove the following results.

Theorem 2 (i) If $a_1 \geq a_2$, then the steady state $x^* = \frac{1}{a_1+a_2}$ is asymptotically stable for all delay $\tau \geq 0$.

(ii) If $a_1 < a_2$, then there is a critical value τ_0 given by

$$\tau_0 = \frac{a_1 + a_2}{r\sqrt{a_2^2 - a_1^2}} \arcsin \frac{\sqrt{a_2^2 - a_1^2}}{a_2},$$

such that $x^* = \frac{1}{a_1+a_2}$ is asymptotically stable when $\tau \in [0, \tau_0)$ and unstable when $\tau > \tau_0$. A Hopf bifurcation occurs at x^* when τ passes through τ_0 .

The above result indicates that if $a_1 \geq a_2$, that is, if the instantaneous term is dominant, then the steady state $x^* = \frac{1}{a_1+a_2}$ is asymptotically stable for all delay $\tau \geq 0$. In fact, we can show that it is asymptotically stable for any initial value, that is, globally stable.

Theorem 3 If $a_1 > a_2$, then the steady state $x^* = \frac{1}{a_1+a_2}$ of (2.8) is globally stable.

Proof. Suppose x is a continuous function from $[-\tau, r)$ to R and denote $x_t(\theta) = x(t + \theta), \theta \in [-\tau, 0]$. Choose a Lyapunov function of the form

$$V(x(t), x_t(\theta)) = x - x^* - x^* \ln \frac{x}{x^*} + \xi \int_{-\tau}^0 [x_t(\theta)]^2 d\theta, \tag{2.9}$$

where $\xi > 0$ is a constant to be determined. Rewrite equation (2.8) as follows:

$$\frac{dx}{dt} = rx(t)[-a_1(x(t) - x^*) - a_2(x(t - \tau) - x^*)]. \quad (2.10)$$

Then we have

$$\begin{aligned} \left. \frac{dV}{dt} \right|_{(2.10)} &= \frac{dx}{dt} \frac{x - x^*}{x} + \xi[(x(t) - x^*)^2 - (x(t - \tau) - x^*)^2] \\ &= -\{(ra_1 - \xi)[x(t) - x^*]^2 + ra_2[x(t) - x^*][x(t - \tau) - x^*] \\ &\quad + \xi[x(t - \tau) - x^*]^2\}. \end{aligned}$$

If $a_1 > a_2$, choose $\xi = \frac{1}{2}ra_1$, so $\left. \frac{dV}{dt} \right|_{(2.10)}$ is negatively definite and the result follows. ■

3. Recruitment Models

3.1 Nicholson's Blowflies Model

The Hutchinson's equation (2.1) can be used to explain several experimental situations, including Nicholson's (1954) careful experimental data of the Australian sheep-blowfly (*Lucila cuprina*). Over a period of nearly two years Nicholson recorded the population of flies and observed a regular basic periodic oscillation of about 35-40 days. To apply the Hutchinson's equation (2.1), K is set by the food level available, τ is approximately the time for a larva to mature into an adult. The only unknown parameter is r , the intrinsic growth rate of the population. If we take the observed period as 40 days, then the delay is about 9 days: the actual delay is about 15 days.

To overcome the discrepancy in estimating the delay value, Gurney et al. (1980) tried to modify Hutchinson's equation. Notice that Nicholson's data on blowflies consist primarily of observations of the time variation of adult population. Let $x(t)$ denote the population of sexually mature adults. Then the rate of change of $x(t)$ is the instantaneous rate of recruitment to the adult population $R(t)$ minus the instantaneous total death rate $D(t)$:

$$\frac{dx}{dt} = R(t) - D(t).$$

To express $R(t)$ we have to consider the populations of all the various stages in the life-history of the species concerned and make the following assumptions:

- (i) all eggs take exactly τ time units to develop into sexually mature adults;

- (ii) the rate at which the adult population produces eggs depends only on its current size;
- (iii) the probability of a given egg maturing into a viable adult depends only on the number of competitors of the same age.

These imply that the rate of recruitment at time $t + \tau$ is a function only of the instantaneous size of the adult population at time t . Assume that the average per capita fecundity drops exponentially with increasing population, thus

$$R(t + \tau) = \theta(x(t)) = Px(t) \exp[-x(t)/x_0],$$

where P is the maximum per capita daily egg production rate, x_0 is the size at which the blowflies population reproduces at its maximum rate, and δ is the per capita daily adult death rate.

Assume that the per capita adult death rate has a time and density independent value δ . The additional assumption that the total death rate $D(t)$ is a function only of the instantaneous size of the adult population

$$D(t) = \phi(x(t)) = \delta x(t)$$

enables the entire population dynamics to be expressed in the delay differential equation

$$\frac{dx}{dt} = Px(t - \tau) \exp\left[-\frac{x(t - \tau)}{x_0}\right] - \delta x(t). \quad (3.1)$$

There is a positive equilibrium

$$x^* = x_0 \ln(P/\delta)$$

if the maximum possible per capita reproduction rate is greater than the per capita death rate, that is, if $P > \delta$. As in the Hutchinson's equation, there is a critical value of the time delay. The positive equilibrium is stable when the delay is less the critical value, becomes unstable when it is greater the value, and there are oscillations. Testing Nicholson's data, equation (3.1) not only provides self-sustaining limit cycles as the Hutchinson's equation did, but also gives an accurate measurement of the delay value as 15 days. Gurney et al. (1980) showed that the fluctuations observed by Nicholson are quite clear, of limit-cycle type (see Fig. 11.4). The period of the cycles is set mainly by the delay and adult death rate. High values of $P\tau$ and $\delta\tau$ will give large amplitude cycles. Moving deeper into instability produces a number of successive doublings of the repeated time until a region is reached where the solution becomes aperiodic (chaotic). See Fig. 11.5.

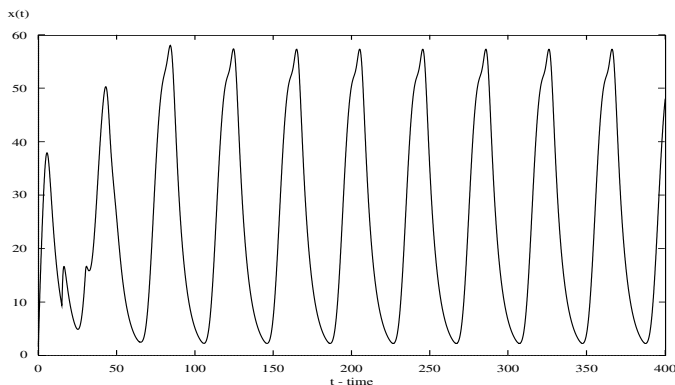

Figure 11.4. Oscillations in the Nicholson's blowflies equation (3.1). Here $P = 8$, $x_0 = 4$, $\delta = 0.175$, and $\tau = 15$.

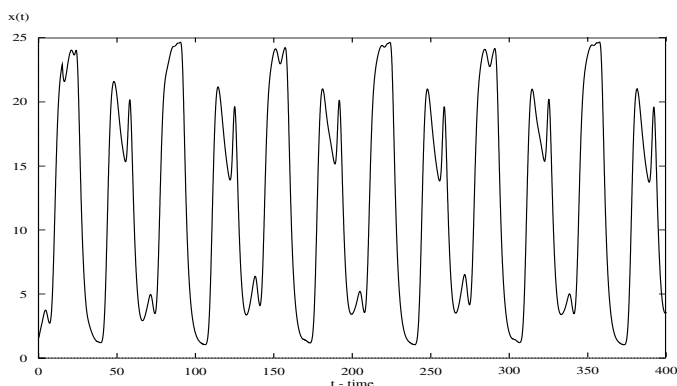

Figure 11.5. Aperiodic oscillations in the Nicholson's blowflies equation (3.1). Here $P = 8$, $x_0 = 4$, $\delta = 0.475$, and $\tau = 15$.

Equation (3.1) is now referred to as the *Nicholson's blowflies equation*, see Nisbet and Gurney (1982), Kulenović et al. (1992), So and Yu (1994), Smith (1995), Györi and Trofimchuk (2002), etc.

3.2 Houseflies Model

To describe the oscillations of the adult numbers in laboratory populations of houseflies *Musca domestica*, Taylor and Sokal (1976) proposed the delay equation

$$\frac{dx}{dt} = -dx(t) + bx(t - \tau)[k - bzx(t - \tau)], \quad (3.2)$$

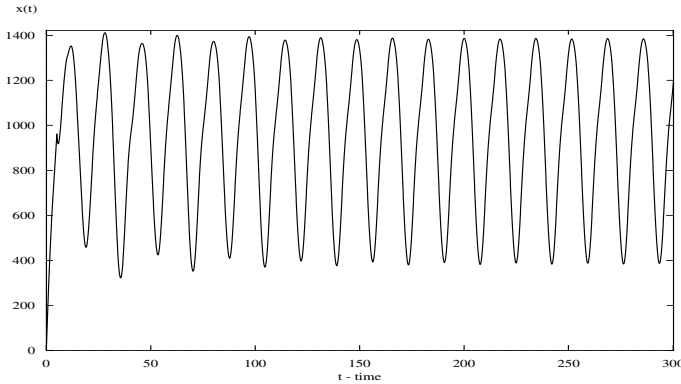

Figure 11.6. Numerical simulations in the houseflies model (3.2). Here the parameter values $b = 1.81$, $k = 0.5107$, $d = 0.147$, $z = 0.000226$, $\tau = 5$ were reported in Taylor and Sokal (1976).

where $x(t)$ is the number of adults, $d > 0$ denotes the death rate of adults, the time delay $\tau > 0$ is the length of the developmental period between oviposition and eclosion of adults. The number of eggs laid is assumed to be proportional to the number of adults, so at time $t - \tau$ the number of new eggs would be $bx(t - \tau)$, where $b > 0$ is the number of eggs laid par adult. $k - bzx(t - \tau)$ represents the egg-to-adult survival rate, where $k > 0$ is the maximum egg-adult survival rate, and z is the reduction in survival produced by each additional egg. Notice that when there is no time delay, i.e., $\tau = 0$, then the equation becomes the familiar logistic equation.

Though analytical analysis of equation (3.2) has never been carried out, numerical simulations indicate that its dynamics are very similar to that of the Nicholson's blowflies equation (see Fig. 11.6). However, unlike the Nicholson's model, aperiodic oscillations have not been observed.

3.3 Recruitment Models

Blythe et al. (1982) proposed a general single species population model with a time delay

$$\frac{dx}{dt} = R(x(t - \tau)) - Dx(t), \quad (3.3)$$

where R and D represent the rates of recruitment to, and death rate from, an adult population of size x , and $\tau > 0$ is the maturation period. For a linear analysis of the model, see Brauer and Castillo-Chávez (2001).

This equation could exhibit very complex dynamic behavior for some functions R , such as $R(x(t - \tau)) = Px(t - \tau) \exp[-x(t - \tau)/x_0]$ in the Nicholson's blowflies equation. However, for some other functions, for example

$$R(x(t - \tau)) = \frac{bx^2(t - \tau)}{x(t - \tau) + x_0} \left[1 - \frac{x(t - \tau)}{K} \right]$$

as in Beddington and May (1975), the time delay is not necessarily destabilizing (see also Rodríguez (1998)).

Freedman and Gopalsamy (1986) studied three classes of general single species models with a single delay and established criteria for the positive equilibrium to be globally stable independent of the length of delay. See also Cao and Gard (1995), Karakostas et al. (1992).

4. The Allee Effect

The logistic equation was based on the assumption that the density has a negative effect on the per-capita growth rate. However, some species often cooperate among themselves in their search for food and to escape from their predators. For example some species form hunting groups (packs, prides, etc.) to enable them to capture large prey. Fish and birds often form schools and flocks as a defense against their predators. Some parasitic insects aggregate so that they can overcome the defense mechanism of a host. A number of social species such as ants, termites, bees, etc., have developed complex cooperative behavior involving division of labor, altruism, etc. Such cooperative processes have a positive feedback influence since individuals have been provided a greater chance to survive and reproduce as density increase. Aggregation and associated cooperative and social characteristics among members of a species were extensively studied in animal populations by Allee (1931), the phenomenon in which reproduction rates of individuals decrease when density drops below a certain critical level is now known as the *Allee effect*.

Gopalsamy and Ladas (1990) proposed a single species population model exhibiting the Allee effect in which the per capita growth rate is a quadratic function of the density and is subject to time delays:

$$\frac{dx}{dt} = x(t)[a + bx(t - \tau) - cx^2(t - \tau)], \quad (4.1)$$

where $a > 0, c > 0, \tau \geq 0$, and b are real constants. In the model, when the density of the population is not small, the positive feedback effects of aggregation and cooperation are dominated by density-dependent stabilizing negative feedback effects due to intraspecific competition. In other

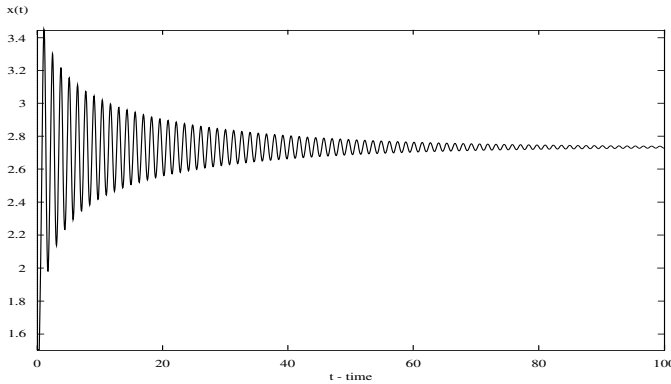

Figure 11.7. The steady state of the delay model (4.1) is attractive. Here $a = 1, b = 1, c = 0.5, \tau = 0.2$.

words, intraspecific mutualism dominates at low densities and intraspecific competition dominates at higher densities.

Equation (4.1) has a positive equilibrium

$$x^* = \frac{b + \sqrt{b^2 + 4ac}}{2c}.$$

Gopalsamy and Ladas (1990) showed that under some restrictive assumptions, the positive equilibrium is globally attractive (see Fig. 11.7). If the delay is sufficiently large, solutions of equation (4.1) oscillate about the positive equilibrium. See also Cao and Gard (1995). The following result is a corollary of the main results of Liz et al. (2003).

Theorem 4 *If*

$$\tau x^*(2cx^* - b) \leq \frac{3}{2},$$

then the equilibrium x^ attracts all positive solutions of (4.1).*

Ladas and Qian (1994) generalized (4.1) to the form

$$\frac{dx}{dt} = x(t)[a + bx^p(t - \tau) - cx^q(t - \tau)], \quad (4.2)$$

where p, q are positive constants, and discussed oscillation and global attractivity in the solutions.

5. Food-Limited Models

Rewriting the logistic equation (2.1) as

$$\frac{1}{x(t)} \frac{dx}{dt} = r \left(1 - \frac{x}{K}\right),$$

we can see that the average growth rate of a population is a linear function of its density. In experiments of bacteria cultures *Daphnia magna* Smith (1963) found that the average growth rate $(1/x)(dx/dt)$ is not a linear function of the density. Smith argued that the per capita growth rate of a population is proportional to the rate of food supply not momentarily being used. This results in the model:

$$\frac{1}{x} \frac{dx}{dt} = r \left(1 - \frac{F}{T} \right), \quad (5.1)$$

where F is the rate at which a population of biomass x consumes resources, and T is the rate at which the population uses food when it is at the equilibrium K . Note that F/T is not usually equal to x/K . It is assumed that F depends on the density x (that is being maintained) and dx/dt (the rate of change of the density) and takes the following form:

$$F = c_1x + c_2 \frac{dx}{dt}, \quad c_1 > 0, \quad c_2 \geq 0.$$

When saturation is attained, $dx/dt = 0$, $x = K$ and $T = F$. Thus, $T = c_1K$ and equation (5.1) becomes

$$\frac{1}{x} \frac{dx}{dt} = r \left[1 - \frac{c_1x + c_2 \frac{dx}{dt}}{c_1K} \right].$$

If we let $c = c_2/c_1 \geq 0$, the above equation can be simplified to the form

$$\frac{1}{x(t)} \frac{dx(t)}{dt} = r \left[\frac{K - x(t)}{K + rcx(t)} \right], \quad (5.2)$$

which is referred to as the *food-limited* population model. Equation (5.2) has also been discussed by Hallam and DeLuna (1984) in studying the effects of environmental toxicants on populations.

Gopalsamy et al. (1988) introduced a time delay $\tau > 0$ into (5.2) and obtained the delayed food-limited model

$$\frac{dx}{dt} = rx(t) \left[\frac{K - x(t - \tau)}{K + rcx(t - \tau)} \right]. \quad (5.3)$$

They studied global attractivity of the positive equilibrium $x^* = K$ and oscillation of solutions about $x^* = K$ (see Fig. 11.8). The dynamics are very similar to the Hutchinson's model.

For other related work on equation (5.3) and its generalizations, see Gopalsamy et al. (1990a), Grove et al. (1993), So and Yu (1995), Qian (1996), etc.

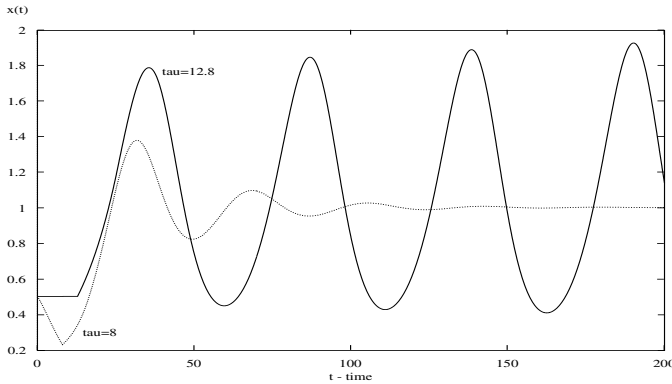

Figure 11.8. The steady state of the delay food-limited model (5.3) is stable for small delay ($\tau = 8$) and unstable for large delay ($\tau = 12.8$). Here $r = 0.15$, $K = 1.00$, $c = 1$.

6. Regulation of Haematopoiesis

Haematopoiesis is the process by which primitive stem cells proliferate and differentiate to produce mature blood cells. It is driven by highly coordinated patterns of gene expression under the influence of growth factors and hormones. The regulation of haematopoiesis is about the formation of blood cell elements in the body. White and red blood cells are produced in the bone marrow from where they enter the blood stream. The principal factor stimulating red blood cell product is the hormone produced in the kidney, called erythropoiesis. About 90% of the erythropoiesis is secreted by renal tubular epithelial cells when blood is unable to deliver sufficient oxygen. When the level of oxygen in the blood decreases this leads to a release of a substance, which in turn causes an increase in the release of the blood elements from the marrow. There is a feedback from the blood to the bone marrow. Abnormalities in the feedback are considered as major suspects in causing periodic haematological disease.

6.1 Mackey-Glass Models

Let $c(t)$ be the concentration of cells (the population species) in the circulating blood with units cells/mm³. Assume that the cells are lost at a rate proportional to their concentration, say, gc , where g has dimension (day⁻¹). After the reduction in cells in the blood stream there is about a 6-day delay before the marrow releases further cells to replenish the deficiency. Assume the flux of cells into the blood stream depends on the cell concentration at an earlier time, $c(t - \tau)$, where τ is the delay.

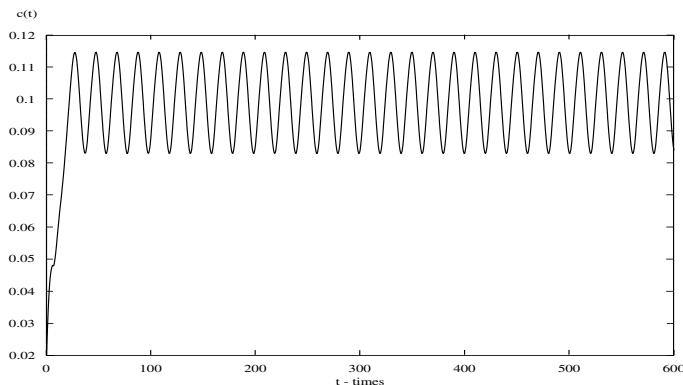

Figure 11.9. Oscillations in the Mackey-Glass model (6.1). Here $\lambda = 0.2$, $a = 01$, $g = 0.1$, $m = 10$ and $\tau = 6$.

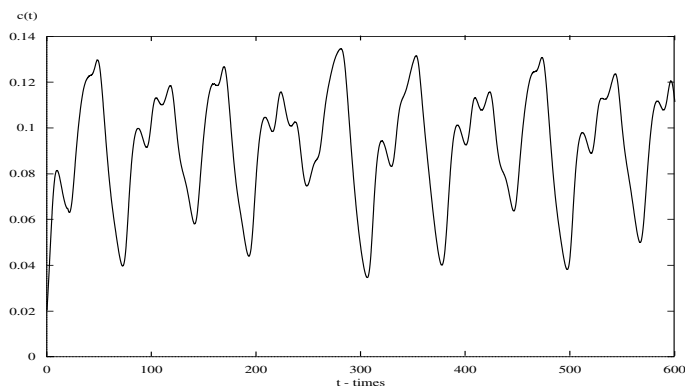

Figure 11.10. Aperiodic behavior of the solutions of the Mackey-Glass model (6.1). Here $\lambda = 0.2$, $a = 01$, $g = 0.1$, $m = 10$ and $\tau = 20$.

Mackey and Glass (1977) suggested, among others, the following delay model for the blood cell population

$$\frac{dc}{dt} = \frac{\lambda a^m c(t - \tau)}{a^m + c^m(t - \tau)} - gc(t), \quad (6.1)$$

where λ , a , m , g and τ are positive constants. The numerical simulations of equation (6.1) by Mackey and Glass (1977) (see also Mackey and Milton (1988)) indicate that there is a cascading sequence of bifurcating periodic solutions when the delay is increased (see Fig. 11.9). When the delay is further increased the periodic solutions becomes aperiodic and chaotic (see Fig. 11.10).

6.2 Wazewska-Czyzewska and Lasota Model

Another well-known model belongs to Wazewska-Czyzewska and Lasota (1976) which takes the form

$$\frac{dN}{dt} = -\mu N(t) + pe^{-\gamma N(t-\tau)}, \quad (6.2)$$

where $N(t)$ denotes the number of red-blood cells at time t , μ is the probability of death of a red-blood cell, p and γ are positive constants related to the production of red-blood cells per unit time and τ is the time required to produce a red-blood cells. See also Arino and Kimmel (1986).

Global attractivity in the Mackey-Glass model (6.1) and the Lasota-Wazewska model (6.2) has been studied by Gopalsamy et al. (1990b), Karakostas et al. (1992), Kuang (1992) and Györi and Trofimchuk (1999). Liz et al. (2002) study these models when the delay is infinite.

Other types of delay physiological models can be found in Mackey and Milton (1988,1990) and Fowler and Mackey (2002).

7. A Vector Disease Model

Let $y(t)$ denote the infected host population and $x(t)$ be the population of uninfected human. Assume that the total host population is constant and is scaled so that

$$x(t) + y(t) = 1.$$

The disease is transmitted to the host by an insect vector, assumed to have a large and constant population, and by the host to that vector. Within the vector there is an incubation period τ before the disease agent can infect a host. So the population of vectors capable of infecting the host is

$$z(t) = dy(t - \tau).$$

where d is the infective rate of the vectors. Infection of the host is assumed to proceed at a rate (e) proportional to encounters between uninfected host and vectors capable of transmitting the disease,

$$ex(t) \cdot dy(t - \tau) = by(t - \tau)[1 - y(t)],$$

and recovery to proceed exponentially at a rate c . Thus, b is the contact rate. Infection leads neither to death, immunity or isolation. Based on these assumptions, Cooke (1978) proposed a delay model

$$\frac{dy}{dt} = by(t - \tau)[1 - y(t)] - ay(t), \quad (7.1)$$

where $a > 0$ is the cure rate.

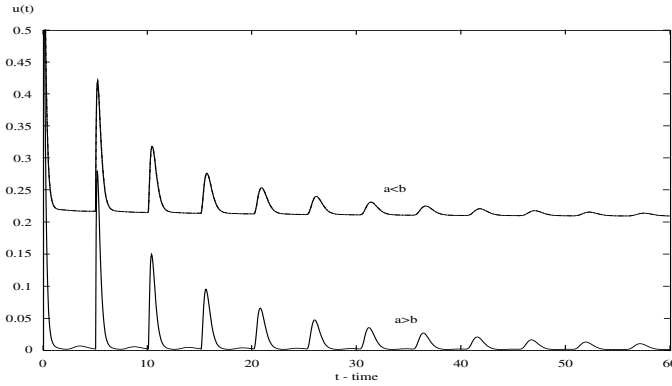

Figure 11.11. Numerical simulations for the vector disease equation (7.1). When $a = 5.8, b = 4.8 (a > b)$, the zero steady state $u = 0$ is asymptotically stable; When $a = 3.8, b = 4.8 (a < b)$, the positive steady state u^* is asymptotically stable for all delay values; here for both cases $\tau = 5$.

Using the Liapunov functional method, he obtained the following results on global stability of the steady states.

Theorem 5 For the vector disease model (7.1), we have the following:

- (i) If $0 < b \leq a$, then the steady state solution $u_0 = 0$ is asymptotically stable and the set $\{\phi \in ([-\tau, 0], \mathcal{R}) : 0 \leq \phi(\theta) \leq 1 \text{ for } -\tau \leq \theta \leq 0\}$ is a region of attraction.
- (ii) If $0 \leq a < b$, then the steady state solution $u_1 = (b - a)/b$ is asymptotically stable and the set $\{\phi \in ([-\tau, 0], \mathcal{R}) : 0 < \phi(\theta) \leq 1 \text{ for } -\tau \leq \theta \leq 0\}$ is a region of attraction.

The stability results indicate that there is a *threshold* at $b = a$. If $b \leq a$, then the proportion u of infectious individuals tends to zero as t becomes large and the disease dies out. If $b > a$, the proportion of infectious individuals tends to an endemic level $u_1 = (b - a)/b$ as t becomes large. There is no non-constant periodic solutions in the region $0 \leq u \leq 1$. Numerical simulations are given in Fig. 11.11.

Busenberg and Cooke (1978) studied the existence of periodic solutions in the vector-host model (7.1) when $b = b(t)$ is a positive periodic function.

8. Multiple Delays

Kitching (1977) pointed out that the life cycle of the Australian blowfly *Lucila cuprina* has multiple time delay features which need to be considered in modelling its population. Based on this observation, Braddock and van den Driessche (1983) proposed the two delay logistic equation (see also Gopalsamy (1990))

$$\frac{dx}{dt} = rx(t)[1 - a_1x(t - \tau_1) - a_2x(t - \tau_2)], \tag{8.1}$$

where r, a_1, a_2, τ_1 and τ_2 are positive constants. Other equations with two delays appear in neurological models (Bélair and Campbell (1994)), physiological models (Beuter et al. (1993)), medical models (Bélair et al. (1995)), epidemiological models (Cooke and Yorke (1973)), etc. Very rich dynamics have been observed in such equations (Hale and Huang (1993), Mahaffy et al. (1995)).

Equation (8.1) has a positive equilibrium $x^* = 1/(a_1 + a_2)$. Let $x(t) = x^*(1 + X(t))$. Then (8.1) becomes

$$\dot{X}(t) = -(1 + X(t))[A_1X(t - \tau_1) + A_2X(t - \tau_2)], \tag{8.2}$$

where $A_1 = ra_1x^*, A_2 = ra_2x^*$. The linearized equation of (8.2) at $X = 0$ is

$$\dot{X}(t) = -A_1X(t - \tau_1) - A_2X(t - \tau_2).$$

Braddock and van den Driessche (1983) described some linear stability regions for equation (8.1) and observed stable limit cycles when τ_2/τ_1 is large. Gopalsamy (1990) obtained stability conditions for the positive equilibrium. Using the results in Li et al. (1999), we can obtain the following theorem on the stability and bifurcation of equation (8.1).

Theorem 6 *If one of the following conditions is satisfied:*

- (i) $A_1 < A_2$ and $\tau_1 > 0$ such that $\frac{\pi}{2\tau_1} < \sqrt{A_2^2 - A_1^2} < \frac{3\pi}{2\tau_1}$;
- (ii) $A_2 < A_1$ and $\bar{\tau}_1 > \frac{\pi}{2(A_1+A_2)}$ such that $\tau_1 \in [\frac{\pi}{2(A_1+A_2)}, \bar{\tau}_1]$, where

$$\bar{\tau}_1 = (A_1^2 - A_2^2)^{-\frac{1}{2}} \arcsin \sqrt{(A_1^2 - A_2^2)/A_1^2};$$

- (iii) $A_1 = A_2$ and $\tau_1 > \frac{1}{2A_1}$;

then there is a $\tau_2^0 > 0$, such that when $\tau_2 = \tau_2^0$ the two-delay equation (8.1) undergoes a Hopf bifurcation at $x^* = 1/(a_1 + a_2)$.

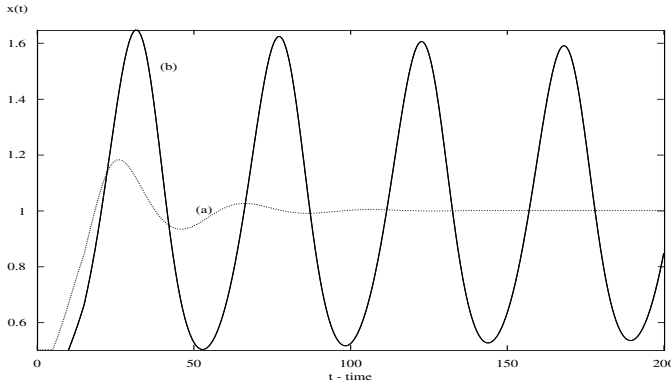

Figure 11.12. For the two delay logistic model (8.1), choose $r = 0.15$, $a_1 = 0.25$, $a_2 = 0.75$. (a) The steady state (a) is stable when $\tau_1 = 15$ and $\tau_2 = 5$ and (b) becomes unstable when $\tau_1 = 15$ and $\tau_2 = 10$, a Hopf bifurcation occurs.

Lenhart and Travis (1986) studied the global stability of the multiple delay population model

$$\frac{dx}{dt} = x(t) \left[r + ax(t) + \sum_{i=1}^n b_i x(t - \tau_i) \right]. \quad (8.3)$$

Their global stability conditions very much depend on the negative, instantaneously dominated constant a . It would be interesting to determine the dynamics of the multiple-delay logistic equation without the negative instantaneously dominated term (see Kuang (1993))

$$\frac{dx}{dt} = rx(t) \left[1 - \sum_{i=1}^n \frac{x(t - \tau_i)}{K_i} \right]. \quad (8.4)$$

9. Volterra Integrodifferential Equations

The Hutchinson's equation (2.1) means that the regulatory effect depends on the population at a fixed earlier time $t - \tau$, rather than at the present time t . In a more realistic model the delay effect should be an average over past populations. This results in an equation with a *distributed delay* or an *infinite delay*. The first work using a logistic equation with distributed delay was by Volterra (1934) with extensions by Kostitzin (1939). In the 1930's, many experiments were performed with laboratory populations of some species of small organisms with short generation time. Attempts to apply logistic models to these experiments were often unsuccessful because populations died out. One of

the causes was the pollution of the closed environment by waste products and dead organisms. Volterra (1934) used an integral term or a distributed delay term to examine a cumulative effect in the death rate of a species, depending on the population at all times from the start of the experiment. The model is an *integro-differential equation*

$$\frac{dx}{dt} = rx \left[1 - \frac{1}{K} \int_{-\infty}^t G(t-s)x(s)dx \right], \quad (9.1)$$

where $G(t)$, called the *delay kernel*, is a weighting factor which indicates how much emphasis should be given to the size of the population at earlier times to determine the present effect on resource availability. Usually the delay kernel is normalized so that

$$\int_0^{\infty} G(u)du = 1.$$

In this way we ensure that for equation (9.1) the equilibrium of the instantaneous logistic equation (1.3) remains an equilibrium in the presence of time delay. If $G(u)$ is the Dirac function $\delta(\tau - t)$, where

$$\int_{-\infty}^{\infty} \delta(\tau - s)f(s)ds = f(\tau),$$

then equation (9.1) reduces to the discrete delay logistic equation

$$\frac{dx}{dt} = rx(t) \left[1 - \frac{1}{K} \int_{-\infty}^t \delta(t - \tau - s)x(s)dx \right] = rx(t) \left[1 - \frac{x(t - \tau)}{K} \right].$$

The *average delay* for the kernel is defined as

$$T = \int_0^{\infty} uG(u)du.$$

It follows that if $G(u) = \delta(u - \tau)$, then $T = \tau$, the discrete delay. We usually use the Gamma distribution delay kernel

$$G(u) = \frac{\alpha^n u^{n-1} e^{-\alpha u}}{(n-1)!}, \quad n = 1, 2, \dots \quad (9.2)$$

where $\alpha > 0$ is a constant, n an integer, with the average delay $T = n/\alpha$. Two special cases,

$$G(u) = \alpha e^{-\alpha u} \quad (n = 1), \quad G(u) = \alpha^2 u e^{-\alpha u}; \quad (n = 2),$$

are called *weak delay kernel* and *strong delay kernel*, respectively. The weak kernel qualitatively indicates that the maximum weighted response

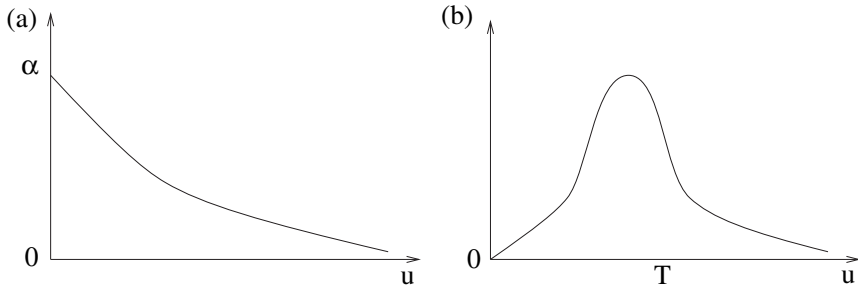

Figure 11.13. (a) Weak delay kernel and (b) strong delay kernel.

of the growth rate is due to current population density while past densities have (exponentially) decreasing influence. On the other hand the strong kernel means that the maximum influence on growth rate response at any time t is due to population density at the previous time $t - T$ (see Fig. 11.13).

The initial value for the integro-differential equation (9.1) is

$$x(\theta) = \phi(\theta) \geq 0, \quad -\infty < \theta \leq 0, \quad (9.3)$$

where $\phi(\theta)$ is continuous on $(-\infty, 0]$. Following Volterra (1931) or Miller (1971), we can obtain existence, uniqueness, continuity and continuation about solutions to such a kind of integro-differential equations.

An equilibrium x^* of equation (9.1) is called *stable* if given any $\epsilon > 0$ there exists a $\delta = \delta(\epsilon) > 0$ such that $|\phi(t) - x^*| \leq \delta$ for $t \in (-\infty, 0]$ implies that any solution $x(t)$ of (9.1) and (9.3) exists and satisfies $|x(t) - x^*| < \epsilon$ for all $t \geq 0$. If in addition there exists a constant $\delta_0 > 0$ such that $|\phi(t) - x^*| \leq \delta$ on $(-\infty, 0]$ implies $\lim_{t \rightarrow \infty} x(t) = x^*$, then x^* is called *asymptotically stable*.

9.1 Weak Kernel

To determine the stability of $x^* = K$, let us first consider the equation with a weak kernel, i.e.,

$$\frac{dx}{dt} = rx(t) \left[1 - \frac{1}{K} \int_{-\infty}^t \alpha e^{-\alpha(t-s)} x(s) ds \right]. \quad (9.4)$$

Using the linear chain trick (Fargue (1973) and MacDonald (1978)), define

$$y(t) = \int_{-\infty}^t \alpha e^{-\alpha(t-s)} x(s) ds. \tag{9.5}$$

Then the scalar integro-differential equation (9.4) is equivalent to the following system of two ordinary differential equations

$$\begin{aligned} \frac{dx}{dt} &= rx(t) \left[1 - \frac{1}{K} y(t) \right], \\ \frac{dy}{dt} &= \alpha x(t) - \alpha y(t). \end{aligned} \tag{9.6}$$

Notice that the positive equilibrium of system (9.6) is $(x^*, y^*) = (K, K)$. To determine the stability of (x^*, y^*) , let $X = x - x^*, Y = y - y^*$. The characteristic equation of the linearized system is given by

$$\lambda^2 + \alpha\lambda + \alpha r = 0, \tag{9.7}$$

which has roots

$$\lambda_{1,2} = -\frac{\alpha}{2} \pm \frac{1}{2} \sqrt{\alpha^2 - 4\alpha r}.$$

Therefore, $\text{Re}\lambda_{1,2} < 0$, which implies that $x^* = K$ is locally asymptotically stable.

In fact, $x^* = K$ is globally stable. Rewrite (9.1) as follows:

$$\begin{aligned} \frac{dx}{dt} &= -\frac{r}{K} x(t)(y(t) - y^*), \\ \frac{dy}{dt} &= \alpha(x(t) - x^*) - \alpha(y(t) - y^*). \end{aligned} \tag{9.8}$$

Choose a Liapunov function as follows

$$V(x, y) = x - x^* - x^* \ln \frac{x}{x^*} + \frac{r}{2\alpha K} (y - y^*)^2. \tag{9.9}$$

Along the solutions of (9.8), we have

$$\frac{dV}{dt} = \frac{dx}{dt} \frac{x - x^*}{x} + \frac{r}{\alpha K} (y - y^*) \frac{dy}{dt} = -\frac{r}{K} (y - y^*)^2 < 0.$$

Since the positive quadrant is invariant, it follows that solutions of system (9.8), and hence of (9.1), approach (x^*, y^*) as $t \rightarrow \infty$. Therefore, $x(t) \rightarrow x^*$ as $t \rightarrow \infty$.

The above analysis can be summarized as the following theorem.

Theorem 7 *The positive equilibrium $x^* = K$ of the logistic equation (9.1) with a weak kernel is globally stable (see Fig. 11.14).*

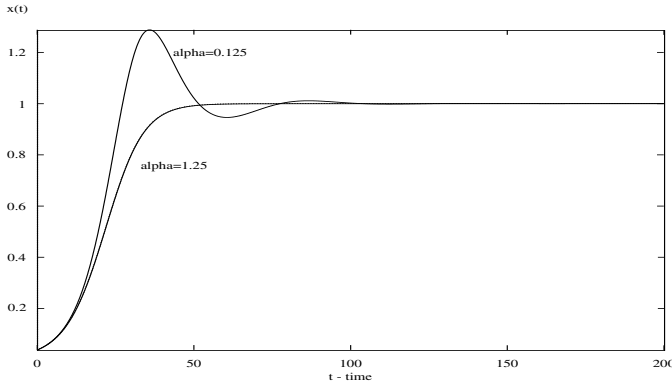

Figure 11.14. The steady state of the integrodifferential equation (9.1) is globally stable. Here $r = 0.15, K = 1.00$.

The result indicates that if the delay kernel is a weak kernel, the logistic equation with distributed delay has properties similar to the instantaneous logistic equation. We shall see that the logistic equation with a strong kernel exhibits richer dynamics similar to the logistic equation with a constant delay.

9.2 Strong Kernel

Consider the logistic equation (9.1) with a strong kernel, i.e.,

$$\frac{dx}{dt} = rx(t) \left[1 - \frac{1}{K} \int_{-\infty}^t \alpha^2(t-s)e^{-\alpha(t-s)}x(t-s)ds \right]. \tag{9.10}$$

To use the linear chain trick, define

$$y(t) = \int_{-\infty}^t \alpha e^{-\alpha(t-s)}x(s)ds, \quad z(t) = \int_{-\infty}^t \alpha^2(t-s)e^{-\alpha(t-s)}x(s)ds.$$

Then equation (9.10) is equivalent to the system

$$\begin{aligned} \frac{dx}{dt} &= rx(t) \left(1 - \frac{1}{K}z(t) \right), \\ \frac{dy}{dt} &= \alpha x(t) - \alpha y(t), \\ \frac{dz}{dt} &= \alpha y(t) - \alpha z(t), \end{aligned} \tag{9.11}$$

which has a positive equilibrium $(x^*, y^*, z^*) = (K, K, K)$. Considering the linearization of (9.11) at (x^*, y^*, z^*) , we obtain the characteristic equation

$$\lambda^3 + a_1\lambda^2 + a_2\lambda + a_3 = 0, \tag{9.12}$$

where

$$a_1 = 2\alpha, \quad a_2 = \alpha^2, \quad a_3 = r\alpha^2.$$

The Routh-Hurwitz criterion says that all roots of the equation (9.12) have negative real parts if and only if the following inequalities hold:

$$a_1 > 0, \quad a_3 > 0, \quad a_1 a_2 - a_3 > 0. \tag{9.13}$$

Clearly, $a_1 = 2\alpha > 0$, $a_3 = r\alpha^2 > 0$. The last inequality becomes

$$\alpha > \frac{r}{2}. \tag{9.14}$$

Thus, the equilibrium $x^* = K$ is stable if $\alpha > r/2$ and unstable if $\alpha < r/2$. Note that the average delay of the strong kernel is defined as $T = 2/\alpha$. Inequality (9.14) then becomes

$$T < \frac{4}{r}. \tag{9.15}$$

Therefore, the equilibrium $x^* = K$ is stable for “short delays” ($T < 4/r$) and is unstable for “long delays” ($T > 4/r$).

When $T = T_0 = 4/r$, (9.12) has a negative real root $\lambda_1 = -r$ and a pair of purely imaginary roots $\lambda_{2,3} = \pm i\frac{r}{2}$. Denote by

$$\lambda(T) = \mu(T) + i\nu(T)$$

the complex eigenvalue of (9.12) such that $u(T_0) = 0$, $\nu(T_0) = r/2$. We can verify that

$$\left. \frac{d\mu}{dT} \right|_{T=\frac{4}{r}} = \frac{8}{5}r^2 > 0. \tag{9.16}$$

The transversality condition (9.16) thus implies that system (9.11) and hence equation (9.10) exhibits a Hopf bifurcation as the average delay T passes through the critical value $T_0 = 4/r$ (Marsden and McKraeken (1976)).

We thus have the following theorem regarding equation (9.10).

Theorem 8 *The positive equilibrium $x^* = K$ of equation (9.10) is asymptotically stable if the average delay $T = 2/\alpha < 4/r$ and unstable if $T > 4/r$. When $T = 4/r$, a Hopf bifurcation occurs at $x^* = K$ and a family of periodic solutions bifurcates from $x^* = K$, the period of the bifurcating solutions is $\frac{\pi}{\nu_0} = \frac{2\pi}{r}$, and the periodic solutions exist for $T > 4/r$ and are orbitally stable.*

Thus, the logistic equation with a strong delay kernel, just like the logistic equation with a discrete delay, exhibits a typical bifurcation phenomenon. As the (average) delay is increased through a critical value the positive equilibrium passes from stability to instability, accompanied by the appearance of stable periodic solutions (see Fig. 11.15).

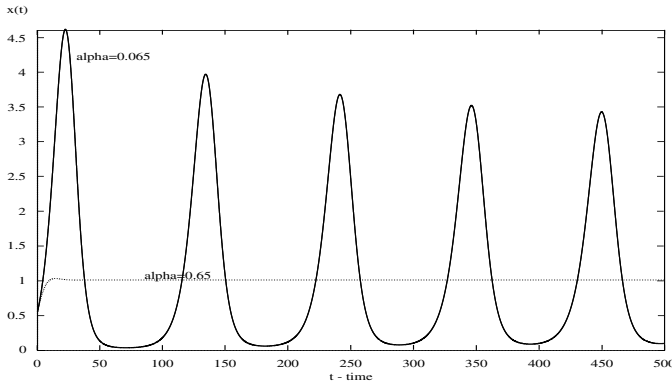

Figure 11.15. The steady state $x^* = K$ of the integrodifferential equation (9.10) loses stability and a Hopf bifurcation occurs when α changes from 0.65 to 0.065. Here $r = 0.15, K = 1.00$.

9.3 General Kernel

Now consider the stability of the equilibrium $x^* = K$ for the integrodifferential equation (9.1) with a general kernel. Let $X = x - K$. Then (9.1) can be written as

$$\frac{dX}{dt} = -r \int_{-\infty}^t G(t-s)X(s)ds + rX(t) \int_{-\infty}^t G(t-s)X(s)ds.$$

The linearized equation about $x = K$ is given by

$$\frac{dX}{dt} = -r \int_{-\infty}^t G(t-s)X(s)ds \tag{9.17}$$

and the characteristic equation takes the form

$$\lambda + r \int_0^{\infty} G(s)e^{-\lambda s} ds = 0. \tag{9.18}$$

If all eigenvalues of the characteristic equation (9.18) have negative real parts, then the solution $X = 0$ of (9.17), that is, the equilibrium $x^* = K$ of (9.1), is asymptotically stable.

Theorem 9 *If*

$$\int_0^{\infty} sG(s)ds < \frac{1}{r},$$

then $x^ = K$ of (9.1) is asymptotically stable.*

Proof. Since the roots of (9.18) coincide with the zeros of the function

$$g(\lambda) = \lambda + r \int_0^\infty G(s)e^{-\lambda s} ds,$$

we may apply the argument principle to $g(\lambda)$ along the contour $\Gamma = \Gamma(a, \varepsilon)$ that constitutes the boundary of the region

$$\{\lambda \mid \varepsilon \leq \operatorname{Re}\lambda \leq a, \quad -a \leq \operatorname{Im}\lambda \leq a, \quad 0 < \varepsilon < a\}.$$

Since the zeros of $g(\lambda)$ are isolated, we may choose a and ε so that no zeros of $g(\lambda)$ lie on Γ . The argument principle now states that the number of zeros of $g(\lambda)$ contained in the region bounded by Γ is equal to the number of times $g(\lambda)$ wraps Γ around the origin as λ traverses Γ . (A zero of $g(\lambda)$ of multiplicity m is counted m times.) Thus, it suffices to show for all small $\varepsilon > 0$ and all large $a > r$, that $g(\lambda)$ does not encircle 0 as λ traverses $\Gamma(a, \varepsilon)$.

Along the segment of Γ given by $\lambda = a + i\nu$, $-a \leq \nu \leq a$, we have

$$g(a + i\nu) = a + i\nu + r \int_0^\infty G(s)e^{-(a+i\nu)s} ds.$$

Since $a > 0$, it follows that

$$\left| \int_0^\infty G(s)e^{-(a+i\nu)s} ds \right| \leq \int_0^\infty G(s) ds = 1.$$

Because $a > r$, we may conclude that every real value assumed by $g(\lambda)$ along this segment must be positive. Along the segment of Γ given by $\lambda = \mu + ia$, $\varepsilon \leq \mu \leq a$, we have

$$g(\mu + ia) = \mu + ia + r \int_0^\infty G(s)e^{-(\mu+ia)s} ds.$$

A similar argument shows $g(\lambda)$ to assume no real value along this path. In fact, $\operatorname{Im}g(\mu + ia)$ is always positive here. Similarly, one can show that $\operatorname{Im}g(\mu - ia)$ is negative along the segment $\lambda = \mu - ia$, $\varepsilon \leq \mu \leq a$. By continuity, $g(\lambda)$ must assume at least one positive real value (and no negative values) as λ travels clockwise from $\varepsilon + ia$ to $\varepsilon - ia$ along Γ .

Finally, consider the path traced out as $\lambda = \varepsilon + i\nu$ increases from $\varepsilon - ia$ to $\varepsilon + ia$. Under the assumption, $\operatorname{Im}g(\varepsilon + i\nu)$ is seen to increase

monotonically with ν . In fact,

$$\begin{aligned} \frac{d}{d\nu} \text{Im}g(\varepsilon + i\nu) &= \frac{d}{d\nu} \left[\nu + r \int_0^\infty G(s)e^{-\varepsilon s} \sin(\nu s) ds \right] \\ &= 1 + r \int_0^\infty sG(s)e^{-\varepsilon s} \cos(\nu s) ds \\ &\geq 1 - r \int_0^\infty sG(s) ds \\ &> 0. \end{aligned}$$

It follows immediately that $g(\lambda)$ assumes precisely one real value along this last segment of Γ . Since no zero of $g(\lambda)$ lies on Γ , that real value is non-zero. Assuming it to be negative, $g(\lambda)$ would have wrapped Γ once about the origin, predicting exactly one zero λ_0 of $g(\lambda)$ inside the region bounded by Γ . Since α and G are real, the zeros of $g(\lambda)$ occur in complex conjugate pairs, forcing λ_0 to be real. This, however, is a contradiction since the positivity of α shows $g(\lambda)$ to have no real positive zeros. Thus, the real value assumed by $g(\lambda)$ along this last segment must be positive. Therefore, $g(\lambda)$ does not encircle the origin. This completes the proof. ■

9.4 Remarks

In studying the local stability of equation (9.1) with weak and strong kernels, we applied the so-called linear chain trick to transform the scalar integrodifferential equation into equivalent a system of first order ordinary differential equations and obtained the characteristic equations (9.7) and (9.12). It should be pointed out that these characteristic equations can be derived directly from the characteristic equation (9.18). If G is a weak kernel, then (9.18) becomes

$$\lambda + r \int_0^\infty \alpha e^{-(\lambda+\alpha)s} ds = \lambda + \frac{\alpha r}{\lambda + \alpha} = 0,$$

which is equation (9.7). If G is a strong kernel, then (9.18) becomes

$$\lambda + r \int_0^\infty \alpha^2 s e^{-(\lambda+\alpha)s} ds = \lambda + \frac{\alpha^2 r}{(\lambda + \alpha)^2} = 0,$$

which is equation (9.12).

One of the varieties of equation (9.1) is the following equation

$$\frac{dx}{dt} = x(t) \left[a - bx(t) - c \int_{-\infty}^t G(t-s)x(s) ds \right], \quad (9.19)$$

where $a > 0$, $b \geq 0$, $c \geq 0$, $b+c \neq 0$. Stability and bifurcation of equation (9.19) have been studied by many researchers. We refer to Miller (1966), Cushing (1977a), MacDonald (1978) and references cited therein. See Corollary 13.

It should be pointed out that bifurcations can occur in equation (9.19) when other coefficients (not necessarily the average delay) are chosen as bifurcation parameters. For example, Landman (1980) showed that there exists a positive a^* such that for $a = a^*$, a steady state becomes unstable and oscillatory solutions bifurcate for a near a^* . See also Simpson (1980).

10. Periodicity

If the environment is not temporally constant (e.g., seasonal effects of weather, food supplies, mating habits, etc.), then the parameters become time dependent. It has been suggested by Nicholson (1933) that any periodic change of climate tends to impose its period upon oscillations of internal origin or to cause such oscillations to have a harmonic relation to periodic climatic changes. Pianka (1974) discussed the relevance of periodic environment to evolutionary theory.

10.1 Periodic Delay Models

Nisbet and Gurney (1976) considered a periodic delay logistic equation and carried out a numerical study of the influence of the periodicity in r and K on the intrinsic oscillations of the equation such as those caused by the time delay. Rosen (1987) noted the existence of a relation between the period of the periodic carrying capacity and the delay of the logistic equation. Zhang and Gopalsamy (1990) assumed that the intrinsic growth rate and the carrying capacity are periodic functions of a period ω and that the delay is an integer multiple of the period of the environment. Namely, they considered the periodic delay differential equation of the form

$$\frac{dx}{dt} = r(t)x(t) \left[1 - \frac{x(t - n\omega)}{K(t)} \right], \quad (10.1)$$

where $r(t + \omega) = r(t)$, $K(t + \omega) = K(t)$ for all $t \geq 0$. They proved the following result on the existence of a unique positive periodic solution of equation (10.1) which is globally attractive with respect to all other positive solutions.

Theorem 10 *Suppose that*

$$\int_0^{n\omega} r(s) ds \leq \frac{3}{2}. \quad (10.2)$$

Then the periodic delay logistic equation (10.1) has a unique positive solution $x^*(t)$ and all other solutions of (10.1) corresponding to initial conditions of the form

$$x(\theta) = \phi(\theta) \geq 0, \quad \phi(0) > 0; \quad \phi \in C[-n\omega, 0]$$

satisfy

$$\lim_{t \rightarrow \infty} |x(t) - x^*(t)| = 0. \quad (10.3)$$

Following the techniques of Zhang and Gopalsamy (1990), quite a few papers have been produced by re-considering the delayed models which appeared in the previous sections with the assumption that the coefficients are periodic. See, for example, the periodic Nicholson's blowflies model (3.1) (Saker and Agarwal (2002)), the periodic Allee effect models (4.1)(Lalli and Zhang (1994)) and (4.2) (Yan and Feng (2003)), the periodic food-limited model (5.3) (Gopalsamy et al. (1990a)), the periodic Wazewska-Czyzewska and Lasota model (6.2) (Greaif et al. (1996)), etc. In all these papers, the delays are assumed to be integral multiples of periods of the environment. The coincidence degree theory (Gaines and Mawhin (1977)) has also been used to establish the existence of periodic solutions in periodic models with general periodic delays. However uniqueness is not guaranteed and stability can be obtained only when the delays are constant (Li (1998)).

Freedman and Wu (1992) considered the following single-species model with a general periodic delay

$$\frac{dx}{dt} = x(t)[a(t) - b(t)x(t) + c(t)x(t - \tau(t))], \quad (10.4)$$

where the net birth rate $a(t) > 0$, the self-inhibition rate $b(t) > 0$, the reproduction rate $c(t) \geq 0$, and the delay $\tau(t) \geq 0$ are continuously differentiable, ω -periodic functions on $(-\infty, \infty)$. This model represents the case that when the population size is small, growth is proportional to the size, and when the population size is not so small, the positive feedback is $a(t) + c(t)x(t - \tau(t))$ while the negative feedback is $b(t)x(t)$. Such circumstance could arise when the resources are plentiful and the reproduction at time t is by individuals of at least age $\tau(t)$ units of time. Using fixed point theorem and Razuminkin technique, they proved the following theorem.

Theorem 11 *Suppose that the equation*

$$a(t) - b(t)K(t) + c(t)K(t - \tau(t)) = 0$$

has a positive, ω -periodic, continuously differentiable solution $K(t)$. Then equation (10.4) has a positive ω -periodic solution $Q(t)$. Moreover, if

$b(t) > c(t)Q(t - \tau(t))/Q(t)$ for all $t \in [0, \omega]$, then $Q(t)$ is globally asymptotically stable with respect to positive solutions of (10.4).

Notice that in equation (10.4), $b(t)$ has to be greater than zero. So Theorem 11 does not apply to the periodic delay logistic equation

$$\frac{dx}{dt} = r(t)x(t) \left[1 - \frac{x(t - \tau(t))}{K(t)} \right] \tag{10.5}$$

where $\tau(t)$ a positive periodic function. As Schley and Gourley (2000) showed, the periodic delays can have either a stabilizing effect or a destabilizing one, depending on the frequency of the periodic perturbation. It is still an open problem to study the dynamics, such as existence, uniqueness and stability of periodic solutions and bifurcations, for the periodic delay logistic equation (10.5).

10.2 Integrodifferential Equations

Periodic logistic equations with distributed delay have been systematically studied in Cushing (1977a). Bardi and Schiaffino (1982) considered the integrodifferential equation (9.1) when the coefficients are periodic, that is,

$$\frac{dx}{dt} = x(t) \left[a(t) - b(t)x(t) - c(t) \int_{-\infty}^t G(t - s)x(s)ds \right]. \tag{10.6}$$

where $a > 0$, $b > 0$, $c \geq 0$ are ω -periodic continuous functions on R and $G \geq 0$ is a normalized kernel. Let $C_\omega = C_\omega(R, R)$ denote the Banach space of all ω -periodic continuous functions endowed with the usual supremum norm $\|x\| = \sup |x(t)|$. For $a \in C_\omega$, define the average of a as

$$\langle a \rangle = \frac{1}{\omega} \int_0^\omega a(s)ds.$$

The convolution of the kernel G and a bounded function f is defined by

$$(G * f)(t) = \int_{-\infty}^t G(t - s)f(s)ds.$$

Observe that an ω -periodic solution of (10.6) is a fixed point of the operator $B : \Gamma \rightarrow C_\omega$ defined by

$$(Bx)(t) = u(t), \quad t \in R,$$

where $\Gamma = \{x \in C_\omega : \langle a - c(G * x) \rangle > 0\}$. Since $\langle a \rangle > 0$, $x(t) \equiv 0$ belongs to Γ , that is, Γ is not empty. Define

$$u_0(t) = (B0)(t).$$

Claim I. If x_1 and x_2 belong to Γ with $x_1 \leq x_2$, then $Bx_2 \leq Bx_1$.

In fact, let $\alpha_i(t) = a(t) - c(t)(G * x_i)(t)$ and $u_i(t) = (Bx_i)(t)$ for $t \in R (i = 1, 2)$. Then $\alpha_1(t) \geq \alpha_2(t)$. Since $\alpha_i(t) = \dot{u}_i(t)/u_i(t) + b(t)u_i(t)$, we have $\langle \alpha_i \rangle = \langle bu_i \rangle$ because $u_i(t) (i = 1, 2)$ are periodic. Thus, we deduce that $\langle bu_1 \rangle \geq \langle bu_2 \rangle$ and for some $t_0 \in R, u_2(t_0) \leq u_1(t_0)$. Setting $v(t) = u_1(t) - u_2(t)$, we have

$$\dot{v}(t) \geq (\alpha_1(t) - b(t)(u_1(t) + u_2(t)))v(t),$$

which implies that $v(t) \geq 0$ for all $t \geq t_0$. By the periodicity of $v(t)$, we have $Bx_2 \leq Bx_1$.

Claim II. If v and c belong to C_ω , then $\langle c(G * v) \rangle = \langle v(G * c) \rangle$.

In fact, if we define $G(t) = 0$ for $t < 0$, we have

$$\begin{aligned} \langle c(G * v) \rangle &= \sum_{j=-\infty}^{+\infty} \int_0^\omega c(t) \int_{j\omega}^{(j+1)\omega} G(t-s)v(s)dsdt \\ &= \sum_{j=-\infty}^{+\infty} \int_0^\omega c(t) \int_0^\omega G(t-s-j\omega)v(s)dsdt \\ &= \sum_{j=-\infty}^{+\infty} \int_0^\omega v(t) \int_{-j\omega}^{(1-j)\omega} G(t-s)c(s)dsdt \\ &= \langle v(G * c) \rangle. \end{aligned}$$

Claim III. Let z be a bounded continuous function on R . Then

$$\liminf_{t \rightarrow \infty} (G * z)(t) \geq \liminf_{t \rightarrow \infty} z(t); \quad \limsup_{t \rightarrow \infty} (G * z)(t) \leq \limsup_{t \rightarrow \infty} z(t).$$

We only prove the first inequality. Let $l = \liminf_{t \rightarrow \infty} z(t)$. Choose $\epsilon > 0$ and pick t_ϵ such that $z(t) > l - \epsilon$ for any $t > t_\epsilon$. If $t > t_\epsilon$, we have

$$\begin{aligned} (G * z)(t) &= \int_{-\infty}^{t_\epsilon} G(t-s)z(s)ds + \int_{t_\epsilon}^t G(t-s)z(s)ds \\ &\geq \inf_t z(t) \int_{-\infty}^{t_\epsilon} G(t-s)ds + (l - \epsilon) \int_{t_\epsilon}^t G(t-s)ds. \end{aligned}$$

Hence,

$$\liminf_{t \rightarrow \infty} (G * z)(t) \geq l - \epsilon,$$

which implies the first inequality.

Claim IV. Let $u \in \Gamma$ and let $v(t) > 0$ be the solution of (10.6). Then

$$\begin{aligned} \liminf_{t \rightarrow \infty} (v(t) - u(t)) > 0 &\text{ implies } \liminf_{t \rightarrow \infty} ((Bu)(t) - v(t)) > 0, \\ \limsup_{t \rightarrow \infty} (v(t) - u(t)) < 0 &\text{ implies } \limsup_{t \rightarrow \infty} (Bu)(t) - v(t) < 0. \end{aligned}$$

We prove the first statement. Let $w(t) = (Bu)(t)$, $t \in R$. Then $w(t)$ is a solution of

$$\dot{w}(t) = a(t)w(t) - b(t)w(t)^2 - c(t)w(t)(G * u)(t)$$

while

$$\dot{v}(t) = a(t)v(t) - b(t)v(t)^2 - c(t)v(t)(G * v)(t).$$

Define $z(t) = w(t) - v(t)$. Then

$$\begin{aligned} \dot{z}(t) &= (a(t) - b(t)w(t) - c(t)(G * u))z(t) + c(t)v(t)(G * (v - u))(t) \\ &= (\dot{w}(t)/w(t) - b(t)v(t))z(t) + c(t)v(t)(G * (v - u))(t). \end{aligned}$$

Let $l = \liminf_{t \rightarrow \infty} (v(t) - u(t))$. Because of Claim III, there exists a $t_0 \in R$, such that

$$\dot{z}(t) > (\dot{w}(t)/w(t) - b(t)v(t))z(t) + lc(t)v(t)/2$$

for all $t > t_0$, that is,

$$z(t) > z(t_0) \exp\left\{\int_{t_0}^t \beta(s) ds\right\} + \frac{1}{2} \int_{t_0}^t \exp\left\{\int_s^t \beta(\theta) d\theta\right\} c(s)v(s) ds,$$

where $\beta = \dot{w}(t)/w(t) - b(t)v(t)$. Because $\dot{w}(t)/w(t)$ is periodic and its average is zero, $b(t)v(t)$ is positive and bounded, we can see that $\int_{t_0}^t \beta(s) ds > \gamma_1 - t\gamma_2$, where γ_1 and $\gamma_2 > 0$ are constants. Thus,

$$z(t) > \gamma_3 \int_{t_0}^t \exp((s - t)\gamma) ds = (\gamma_3/\gamma)(1 - \exp((t_0 - t)\gamma_2)),$$

where $\gamma_3 > 0$ is a suitable constant. Then $\liminf_{t \rightarrow \infty} z(t) \geq \gamma_3/\gamma$ which implies the first statement.

Theorem 12 Suppose $\langle a \rangle > 0$. If

$$b(t) > (G * c)(t) \tag{10.7}$$

for any $t \in [0, \omega]$, then equation (10.6) has a unique positive ω -periodic solution $x^*(t)$ which is globally asymptotically stable with respect to all solutions of equation (10.6) under initial condition $x(\theta) = \phi(\theta)$, $\theta \in (-\infty, 0]$, $\phi(0) > 0$.

Proof. Since

$$\dot{u}_0(t)/u_0(t) = a(t) - b(t)u_0(t),$$

the periodicity of $u_0(t)$ and Claim II imply that $\langle a \rangle = \langle bu_0 \rangle > \langle c(G * u_0) \rangle$. As $u_0 > 0$, we have $Bu_0 \leq u_0$. Therefore, for any $v \in C_\omega$ satisfying

$0 < v \leq u_0$, we have $0 < Bu_0 \leq Bv \leq u_0$. Hence, the set $\Gamma_0 = \{v \in C_\omega : 0 < v \leq u_0\} \subset \Gamma$ is invariant under B . Moreover,

$$Bu_0 \leq Bv \leq u_0 \Rightarrow Bu_0 \leq B^2v \leq B^2u_0 \Rightarrow B^3u_0 \leq B^3v \leq B^2u_0$$

and by induction

$$B^{2n+1}u_0 \leq B^{2n+1}v \leq B^{2n}u_0, \quad B^{2n+1}u_0 \leq B^{2n+2}v \leq B^{2n+2}u_0, \quad n = 0, 1, 2, \dots$$

Since $0 < B^20 = Bu_0$, by Claim I, we know that $\{B^{2n+1}u_0\}$ is increasing and $\{B^{2n}u_0\}$ is decreasing. Define

$$u_n(t) = (B^n u_0)(t) = (Bu_{n-1})(t).$$

Then

$$u^-(t) = \lim_{n \rightarrow \infty} u_{2n+1}(t) \quad \text{and} \quad u^+(t) = \lim_{n \rightarrow \infty} u_{2n}(t)$$

exist with $0 < u^-(t) \leq u^+(t)$. If we can show that $u^-(t) = u^+(t) = u^*(t)$, it is easy to see that $u^*(t)$ is the unique fixed point of B . By the definition, we have

$$\dot{u}_n(t) = (a(t) - c(t)(G * u_{n-1})(t))u_n(t) - b(t)u_n(t)^2.$$

By the monotonicity and uniform boundedness of $\{u_n\}$ we have the L^2 -convergence of both u_{2n+1} and u_{2n} and their derivatives. Taking the limits, we have

$$\begin{aligned} \dot{u}^-(t) &= (a(t) - c(t)(G * u^+)(t))u^-(t) - b(t)u^-(t)^2, \\ \dot{u}^+(t) &= (a(t) - c(t)(G * u^-)(t))u^+(t) - b(t)u^+(t)^2. \end{aligned}$$

Dividing them by $u^-(t)$ and $u^+(t)$ respectively, we have

$$\langle a - c(G * u^+) - bu^- \rangle = \langle a - c(G * u^-) - bu^+ \rangle$$

followed by the fact that $\ln u^+$ and $\ln u^-$ are periodic. Let $v(t) = u^+(t) - u^-(t)$. Then we have $\langle c(G * v) \rangle = \langle bv \rangle$. Now by Claim II we have $\langle c(G * v) \rangle = \langle v(G * c) \rangle$. Hence, $\langle v(b - G * c) \rangle = 0$, which implies that $v \equiv 0$ by the assumption (10.7). Therefore, $u^*(t)$ is a unique periodic solution of the equation (10.6).

To prove the global stability, first we show that any solution $v(t)$ of equation (10.6) satisfies $\liminf_{t \rightarrow \infty} v(t) > 0$. In fact, we have

$$\dot{v}(t) < a(t)v(t) - b(t)v(t)^2$$

and

$$\limsup_{t \rightarrow \infty} (v(t) - (Bu)(t)) \leq 0.$$

Choose $\epsilon > 0$ so that $u(t) = u_0(t) + \epsilon \in \Gamma$. By Claim IV we have

$$\liminf_{t \rightarrow \infty} (v(t) - (Bu)(t)) \geq \epsilon.$$

Since $(Bu)(t)$ is strictly positive and periodic, we have $\liminf_{t \rightarrow \infty} v(t) > 0$. Thus, by Claim III, $\liminf_{t \rightarrow \infty} (u_0(t) - v(t)) > 0$ and by induction,

$$\liminf_{t \rightarrow \infty} (v(t) - (B^{2n+1}u_0)(t)) > 0, \quad \limsup_{t \rightarrow \infty} (v(t) - (B^{2n}u_0)(t)) < 0.$$

Given $\epsilon > 0$, choose n such that

$$u^*(t) - \epsilon < (B^{2n+1}u_0)(t) < (B^{2n}u_0)(t) < u^*(t) + \epsilon.$$

Since $(B^{2n+1}u_0)(t) < v(t) < (B^{2n}u_0)(t)$ for large t , it follows that the sequence $\{B^j u\}$ tends to u^* uniformly as $j \rightarrow \infty$. ■

If a, b and c are real positive constants, then condition (10.7) becomes $b > c$. This is the main result in Miller (1966).

Corollary 13 *If $b > c$ and G satisfies the above assumptions, then the positive equilibrium $x^* = a/(b + c)$ of equation (9.19) (with constant coefficient) is globally stable with respect to positive solutions of (9.19).*

For other related work on periodic logistic equations with distributed delay, we refer to Bardi (1983), Cohen and Rosenblat (1982), Cushing (1977a), Karakostas (1982) and the references therein.

11. State-Dependent Delays

Let $x(t)$ denote the size of a population at time t . Assume that the number of births is a function of the population size only. The birth rate is thus density dependent but not age dependent. Assume that the lifespan L of individuals in the population is variable and is a function of the current population size. If we take into account the crowding effects, then $L(\cdot)$ is a decreasing function of the population size.

Since the population size $x(t)$ is equal to the total number of living individuals, we have (Bélair (1991))

$$x(t) = \int_{t-L[x(t)]}^t b(x(s)) ds. \tag{11.1}$$

Differentiating with respect to the time t on both sides of equation (11.1) leads to a state-dependent delay model of the form

$$\frac{dx}{dt} = \frac{b(x(t)) - b(x(t - L[x(t)]))}{1 - L'[x(t)] b(x(t - L[x(t)]))}. \tag{11.2}$$

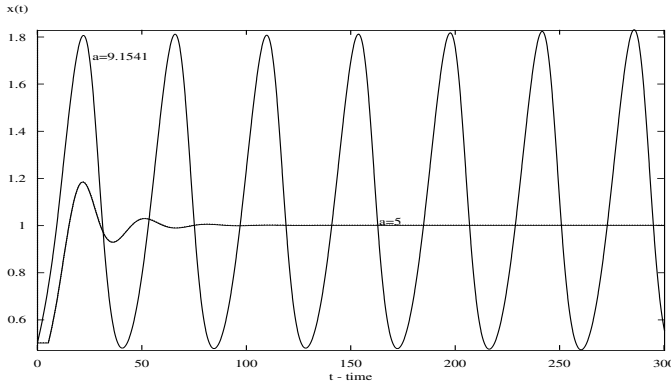

Figure 11.16. Numerical simulations for the state-dependent delay model (11.3) with $r = 0.15$, $K = 1.00$ and $\tau(x) = a + bx^2$. (i) $a = 5$, $b = 1.1$; and (ii) $a = 9.1541$, $b = 1.1$.

Note that state-dependent delay equation (11.2) is not equivalent to the integral equation (11.1). It is clear that every solution of (11.1) is a solution of (11.2) but the reverse is not true. In fact, any constant function is a solution of (11.2) but clearly it may not necessarily be a solution of (11.1). The asymptotic behavior of the solutions of (11.2) has been studied by Bélair (1991). See also Cooke and Huang (1996).

State-dependent delay models have also been introduced by Kirk et al. (1970) to model the control of the bone marrow stem cell population which supplies the circulating red blood cell population. See also Mackey and Milton (1990).

Numerical simulations (see Fig. 11.16) show that the logistic model with a state-dependent delay

$$x'(t) = rx(t) \left[1 - \frac{x(t - \tau(x(t)))}{K} \right], \quad (11.3)$$

has similar dynamics to the Hutchinson's model (2.1). Choose $r = 0.15$, $K = 1.00$ as in Fig. 11.3 for the Hutchinson's model (2.1) and $\tau(x) = a + bx^2$. We observe stability of the equilibrium $x = K = 1$ for small amplitude of $\tau(x)$ and oscillations about the equilibrium for large amplitude of $\tau(x)$ (see Fig. 11.16).

Recently, great attention has been paid on the study of state-dependent delay equations. Consider

$$\varepsilon x'(t) = -x(t) + f(x(t - r(x(t)))) \quad (11.4)$$

and assume that

- (H1) A and B are given positive real numbers and $f : [-B, A] \rightarrow [-B, A]$ is a Lipschitz map with $xf(x) < 0$ for all $x \in [-B, A]$, $x \neq 0$;
- (H2) For A and B in (H1), $r : [-B, A] \rightarrow R$ is a Lipschitz map with $r(0) = 1$ and $r(u) \geq 0$ for all $u \in [-B, A]$;
- (H1') B is a positive real number and $r : [-B, \infty) \rightarrow R$ is a locally Lipschitz map with $r(0) = 1$, $r(u) \geq 0$ for all $u \geq -B$ and $r(-B) = 0$;
- (H2') $f : R \rightarrow R$ is a locally Lipschitz map, and if B is as in (H1') and $A = \sup\{|f(u)| : -B \leq u \leq 0\}$, then $uf(u) < 0$ for all $u \in [-B, A]$, $u \neq 0$.

A periodic solution $x(t)$ of (11.4) is called an *slowly oscillating periodic* (SOP) solution if there exist numbers $q_1 > 1$ and $q_2 > q_1 + 1$ such that

$$x(t) \begin{cases} = 0, & t = 0, \\ < 0, & 0 < t < q_1, \\ = 0, & t = q_1, \\ > 0, & q_1 < t < q_2, \\ = 0, & t = q_2 \end{cases}$$

and $x(t + q_2) = x(t)$ for all t . Mallet-Paret and Nussbaum (1992) proved the following theorem.

Theorem 14 *Assume that f and r satisfy (H1)-(H2) or (H1')-(H2'). Suppose that f is in C^1 near 0 and $f'(0) = -k < -1$. Let ν_0 , $\pi/2 < \nu_0 < \pi$, be the unique solution of $\cos \nu_0 = -1/k$ and define $\lambda_0 = \nu_0/\sqrt{k^2 - 1}$. Then for each $\lambda > \lambda_0$ the equation*

$$x'(t) = -\lambda x(t) + \lambda f(x(t - r(x(t))))$$

has an SOP solution $x_\lambda(t)$ such that $-B < x_\lambda(t) < A$ for all t .

Mallet-Paret and Nussbaum (1996, 2003) studied the shape of general periodic solutions of the equation (11.4) and their limiting profile as $\varepsilon \rightarrow 0^+$. We refer to Arino et al. (1998), Bartha (2003), Kuang and Smith (1992a, 1992b), Mallet-Paret et al. (1994), Magal and Arino (2000), Walther (2002) for existence of periodic solutions; to Krisztin and Arino (2001) for the existence of two dimensional attractors; to Louihi et al. (2002) for semigroup property of the solutions; to Bartha (2001) and Chen (2003) for convergence of solutions, and to Ait Dads and Ezzinbi (2002) and Li and Kuang (2001) for almost periodic and periodic solutions to state-dependent delay equations. See also Arino et al. (2001) for a brief review on state-dependent delay models.

12. Diffusive Models with Delay

Diffusion is a phenomenon by which a group of particles, for example animals, bacteria, cells, chemicals and so on, spreads as a whole according to the irregular motion of each particle. When this microscopic irregular movement results in some macroscopic regular motion of the group, the phenomenon is a *diffusion* process. In terms of randomness, diffusion is defined to be a basically irreversible phenomenon by which particles spread out within a given space according to individual random motion.

12.1 Fisher Equation

Let $u(x, t)$ represent the population density at location x and time t and the source term f represents the birth-death process. With the logistic population growth $f = ru(1 - u/K)$ where r is the linear reproduction rate and K the carrying capacity of the population, the one-dimensional scalar reaction-diffusion equation takes the form (Fisher (1937) and Kolmogorov et al. (1937))

$$\frac{\partial u}{\partial t} = D \frac{\partial^2 u}{\partial x^2} + ru \left(1 - \frac{u}{K} \right), \quad a < x < b, \quad 0 \leq t < \infty, \quad (12.1)$$

which is called the *Fisher equation* or *diffusive logistic equation*. Fisher (1937) proposed the model to investigate the spread of an advantageous gene in a population.

Recall that for the spatially uniform logistic equation

$$\frac{\partial u}{\partial t} = ru \left(1 - \frac{u}{K} \right),$$

the equilibrium $u = 0$ is unstable while the positive equilibrium $u = K$ is globally stable. How does the introduction of the diffusion affect these conclusions? The answer depends on the domain and the boundary conditions. (a) In a finite domain with zero-flux (Neumann) boundary conditions, the conclusions still hold (Fife (1979) and Britton (1986)). (b) Under the Dirichlet conditions, $u = K$ is no longer a solution to the problem. In this case the behaviour of solutions depends on the size of the domain. When the domain is small, $u = 0$ is asymptotically stable, but it loses its stability when the domain exceeds a certain size and a non-trivial steady-state solution becomes asymptotically stable. (c) In an infinite domain the Fisher equation has travelling wave solutions (see Figure 11.17).

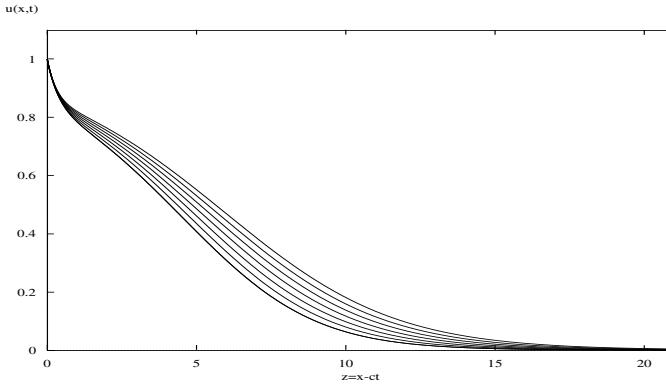

Figure 11.17. The traveling front profiles for the Fisher equation (12.1). Here $D = r = K = 1, c = 2.4 - 3.0$

12.2 Diffusive Equations with Delay

In the last two decades, diffusive biological models with delays have been studied extensively and many significant results have been established. For instance, the diffusive logistic equations with a discrete delay of the form

$$\frac{\partial u(x, t)}{\partial t} = D \frac{\partial^2 u(x, t)}{\partial x^2} + ru(x, t) \left(1 - \frac{u(x, t - \tau)}{K} \right) \quad (12.2)$$

with either Neumann or Dirichlet boundary conditions have been investigated by Green and Stech (1981), Lin and Khan (1982), Yoshida (1982), Morita (1984), Luckhaus (1986), Busenberg and Huang (1996), Feng and Lu (1996), Huang (1998), Freedman and Zhao (1997), Faria and Huang (2002), etc. The diffusive logistic equations with a distributed delay of the form

$$\frac{\partial u(x, t)}{\partial t} = D \frac{\partial^2 u(x, t)}{\partial x^2} + ru(x, t) \left[1 - \frac{1}{K} \int_{-\infty}^t G(t-s)u(x, t-s)ds \right] \quad (12.3)$$

have been studied by Schiaffino (1979), Simpson (1980), Tesei (1980), Gopalsamy and Aggarwala (1981), Schiaffino and A. Tesei (1981), Yamada (1993), Bonilla and Liñán (1984), Redlinger (1985), Britton (1990), Gourley and Britton (1993), Pao (1997), etc.

Recently, researchers have studied the combined effects of diffusion and various delays on the dynamics of the models mentioned in previous sections. For example, for the food-limited model (5.3) with diffusion, Gourley and Chaplain (2002) considered the case when the delay is finite.

Feng and Lu (2003) assumed that the time delay in an integral multiple of the period of the environment and considered the existence of periodic solutions. Davidson and Gourley (2001) studied the model with infinite delay, and Gourley and So (2002) investigated the dynamics when the delay is nonlocal.

The diffusive Nicholson’s blowflies equation

$$\frac{\partial u}{\partial t} = d\Delta u - \tau u(\mathbf{x}, t) + \beta\tau u(\mathbf{x}, t - 1) \exp[-u(\mathbf{x}, t - 1)] \tag{12.4}$$

with Dirichlet boundary conditions has been investigated by So and Yang (1998). They studied the global attractivity of the positive steady state of the equation. Some numerical and bifurcation analysis of this model has been carried out by So, Wu and Yang (1999) and So and Zou (2001).

Gourley and Ruan (2000) studied various local and global aspects of Nicholson’s blowflies equation with infinite delay

$$\frac{\partial u}{\partial t} = d\Delta u - \tau u(\mathbf{x}, t) + \beta\tau \left(\int_{-\infty}^t F(t - s)u(\mathbf{x}, s) ds \right) \exp \left(- \int_{-\infty}^t F(t - s)u(\mathbf{x}, s) ds \right) \tag{12.5}$$

for $(\mathbf{x}, t) \in \Omega \times [0, \infty)$, where Ω is either all of R^n or some finite domain, and the kernel satisfies $F(t) \geq 0$ and the conditions

$$\int_0^\infty F(t) dt = 1 \quad \text{and} \quad \int_0^\infty t F(t) dt = 1. \tag{12.6}$$

Gourley (2000) discussed the existence of travelling waves in equation (12.5).

Ruan and Xiao (2004) considered the diffusive integro-differential equation modeling the host-vector interaction

$$\frac{\partial u}{\partial t}(t, x) = d\Delta u(t, x) - au(t, x) + b[1 - u(t, x)] \int_{-\infty}^t \int_{\Omega} F(t - s, x, y)u(s, y)dyds, \tag{12.7}$$

where $u(t, x)$ is the normalized spatial density of infectious host at time $t \in R_+$ in location $x \in \Omega$, Ω is an open bounded set in R^N ($N \leq 3$), and the convolution kernel $F(t, s, x, y)$ is a positive continuous function in its variables $t \in R, s \in R_+, x, y \in \Omega$, which is normalized so that

$$\int_0^\infty \int_{\Omega} F(t, s, x, y)dyds = 1.$$

Ruan and Xiao (2004) studied the stability of the steady states and proved the following results.

Theorem 15 *The following statements hold*

- (i) *If $0 < b \leq a$, then $u_0 = 0$ is the unique steady state solution of (12.7) in*

$$M = \{u \in E : 0 \leq u(x) \leq 1, x \in \bar{\Omega}\}$$

and it is globally asymptotically stable in $C((-\infty, 0]; M)$.

- (ii) *If $0 \leq a < b$, then there are two steady state solutions in M : $u_0 = 0$ and $u_1 = (b - a)/b$, where u_0 is unstable and u_1 is globally asymptotically stable in $C((-\infty, 0]; M)$.*

Notice that when $F(t, s, x, y) = \delta(x - y)\delta(t - s - \tau)$, where $\tau > 0$ is a constant, and u does not depend on the spatial variable, then equation (12.7) becomes the vector disease model (7.1) and Theorem 15 reduces to Theorem 5 obtained by Cooke (1978).

When $x \in (-\infty, \infty)$ and the kernel is a local strong kernel, i.e.

$$\frac{\partial u}{\partial t} = d\Delta u(t, x) - au(t, x) + b[1 - u(t, x)] \int_{-\infty}^t \frac{t - s}{\tau^2} e^{-\frac{t-s}{\tau}} u(s, x) ds, \tag{12.8}$$

where $(t, x) \in R_+ \times \Omega$, the existence of traveling waves has been established.

Theorem 16 *For any $\tau > 0$ sufficiently small there exist speeds c such that the system (12.8) has a traveling wave solution connecting $u_0 = 0$ and $u_1 = (b - a)/b$.*

The existence of traveling front solutions show that there is a moving zone of transition from the disease-free state to the infective state.

We refer to the monograph by Wu (1996) for a systematic treatment of partial differential equations with delay.

Acknowledgements. The author would like to thank Stephen Cantrell for comments and corrections on an earlier version of the paper.

Chapter 12

WELL-POSEDNESS, REGULARITY AND ASYMPTOTIC BEHAVIOUR OF RETARDED DIFFERENTIAL EQUATIONS BY EXTRAPOLATION THEORY

L. Maniar

Department of Mathematics,

Faculty of Sciences Semlalia,

B.P. 2390, Marrakesh 40000, Morocco.

maniar@ucam.ac.ma

1. Introduction

Consider the following inhomogeneous non-autonomous retarded differential equation

$$(IRDE) \quad \begin{cases} x'(t) &= Ax(t) + L(t)x_t + f(t), & t \geq s, \\ x(\tau) &= \varphi(\tau - s), & \tau \in [s - r, s], \end{cases}$$

where A is a linear (unbounded) operator on a Banach space E , $(L(t))_{t \geq 0}$ is a family of bounded linear operators from the space $C([-r, 0], \bar{E})$ into E , $f : \mathbb{R}_+ \rightarrow E$, and x_t is the function defined on $[-r, 0]$ by $x_t(\theta) = x(t + \theta)$, $\theta \in [-r, 0]$.

The equation (IRDE) has attracted many authors, and has been treated by using different techniques and methods, we cite, for instance, [1, 3, 44, 63, 64, 105, 226, 227, 253]. In these papers, it has been studied the well-posedness of the inhomogeneous autonomous retarded differential equations (IRDE) ($L(t) \equiv L$). It has been also studied the asymptotic behaviour and the regularity properties of the solutions of homogeneous retarded equations (HRDE) ($f \equiv 0$) as well as the asymptotic behaviour of the solutions of the inhomogeneous equations with respect to the inhomogeneous term f .

To profit from the big development of the semigroup theory and its tools (as the perturbation technique), many authors thought to transform the retarded equation (IRDE) to an abstract Cauchy problem (un-

retarded equation) in a product Banach space $\mathcal{X} := E \times C([-r, 0], E)$ as follows

$$(CP)_f \begin{cases} \mathcal{U}'(t) = \mathcal{A}\mathcal{U}(t) + \mathcal{B}(t)\mathcal{U}(t) + \begin{pmatrix} f(t) \\ 0 \end{pmatrix}, & t \geq s, \\ \mathcal{U}(s) = \begin{pmatrix} 0 \\ \varphi \end{pmatrix}, \end{cases}$$

where,

$$\mathcal{A} := \begin{pmatrix} 0 & A\delta_0 - \delta'_0 \\ 0 & \frac{d}{dt} \end{pmatrix},$$

$$D(\mathcal{A}) := \{0\} \times \{\phi \in C^1([-r, 0], E) : \phi(0) \in D(A)\},$$

and

$$\mathcal{B}(t) := \begin{pmatrix} 0 & L(t) \\ 0 & 0 \end{pmatrix}, \quad t \geq 0.$$

The first remark that one can do is that $\mathcal{X}_0 := \overline{D(\mathcal{A})} = \{0\} \times C([-r, 0], E) \neq \mathcal{X}$, which means that the operator \mathcal{A} is not densely defined. One remarks also that the ranges of the perturbation operators $\mathcal{B}(t)$, $t \geq 0$, and the values of the inhomogeneous term $\begin{pmatrix} f(t) \\ 0 \end{pmatrix}$, $t \geq 0$, are not in \mathcal{X}_0 . Hence, one cannot use the standard theory of semigroups to solve neither the perturbation problem $(CP)_0$ nor the inhomogeneous Cauchy problem $(CP)_f$.

H. R. Thieme [224], has showed the existence of mild solutions of the inhomogeneous autonomous Cauchy problem $(CP)_f$, and then the ones of the inhomogeneous autonomous retarded equations, by the introduction of a new variation of constants formula.

To study the well-posedness of the homogeneous non-autonomous retarded differential equations (HRDE), A. Rhandi [199] has proposed the use of the so-called extrapolation theory, introduced by R. Nagel [63]. Using the extrapolation theory, we have also treated, with A. Rhandi, [178] the well-posedness of the inhomogeneous autonomous retarded equations and, together with A. Bátkai, [17], we studied the regularity of the solutions to the homogeneous autonomous equations. With B. Amir [8, 9, 10], also using the extrapolation theory, we have studied the asymptotic behaviour of solutions to the inhomogeneous autonomous retarded equations. Usually by the extrapolation theory, G. Gühring, F. Rábiger and R. Schnaubelt have studied [55, 92, 94, 93] the well-posedness and the asymptotic behaviour of the general inhomogeneous non-autonomous retarded equations (IRDE).

Our contribution in this book consists in the study of the well-posedness, the regularity and the asymptotic behaviour of the solu-

tions of the homogeneous non-autonomous retarded differential equations (HRDE), using the extrapolation theory. Our document is organized as follows:

In section 2, we recall some definitions and important results from the extrapolation theory. More precisely, we define the extrapolation spaces and the extrapolated semigroups for Hille-Yosida operators, introduced by R. Nagel [63], and present some of their important properties. At the end, we present a perturbation of Hille-Yosida operators result, the result is shown in [187, 199].

Section 3 is devoted to the application of the above abstract results, to study the homogeneous non-autonomous retarded differential equations (HRDE). We study the existence of solutions, and that these solutions are given by Dyson-Phillips expansions and satisfy variation of constants formulas. These last results will be crucial to study the regularity and the asymptotic properties of these solutions.

The regularity results, presented in this section, have been also shown by many authors, using alternative different techniques, see, e.g., [1], [105], [226], [227] and [253], but the results concerning the asymptotic behaviour are in our knowledge new.

2. Preliminaries

In this section we introduce the extrapolation spaces and extrapolated semigroups and give all needed abstract results of the extrapolation theory, e.g., perturbation results. For more details we refer to the book [63] and [17, 186]. The extrapolation theory was introduced by R. Nagel [63, 186], and was successfully used in these last years for many purposes, see e.g., [6], [8], [92], [178], [186], [190], [199], [200] and [201].

We recall that a linear operator $(A, D(A))$ on a Banach space X is called a *Hille-Yosida operator* if there are constants $M \geq 1$ and $w \in \mathbb{R}$ such that

$$(w, \infty) \subset \rho(A) \text{ and } \|(\lambda - w)^n R(\lambda, A)^n\| \leq M \quad \text{for all } \lambda > w \text{ and } n \in \mathbb{N}. \tag{2.1}$$

From the Hille-Yosida theorem, we have (cf. [109, Thm. 12.2.4]) the following result.

Proposition 1 *Let $(A, D(A))$ be a Hille-Yosida operator on a Banach space X . Then, the part $(A_0, D(A_0))$ of A in $X_0 := \overline{(D(A), \|\cdot\|)}$ given*

by

$$\begin{aligned} D(A_0) &:= \{x \in D(A) : Ax \in X_0\} \\ A_0x &:= Ax \quad \text{for } x \in D(A_0) \end{aligned}$$

generates a C_0 -semigroup $(T_0(t))_{t \geq 0}$ on X_0 . Moreover, we have $\rho(A) = \rho(A_0)$ and $(\lambda - A_0)^{-1}$ is the restriction of $(\lambda - A)^{-1}$ to X_0 for $\lambda \in \rho(A)$.

Notice that Hille-Yosida operators on reflexive Banach spaces are densely defined.

Proposition 2 *Let $(A, D(A))$ be a Hille-Yosida operator on a reflexive Banach space X . Then $D(A)$ is dense in X and hence A generates a C_0 -semigroup .*

As an immediate consequence of Proposition 2, we have

Corollary 3 *Let $(A, D(A))$ be the generator of a C_0 -semigroup $(T(t))_{t \geq 0}$ on a reflexive Banach space X . Then $(A^*, D(A^*))$ generates the C_0 -semigroup $(T^*(t))_{t \geq 0}$ on X^* .*

From now on, $(A, D(A))$ will be a Hille-Yosida operator on a Banach space X . We define on X_0 the norm

$$\|x\|_{-1} := \|R(\lambda_0, A_0)x\|, \quad x \in X_0,$$

for a fixed $\lambda_0 > \omega$. From the resolvent equation it is easy to see that different $\lambda \in \rho(A)$ yield equivalent norms. The completion X_{-1} of X_0 with respect to $\|\cdot\|_{-1}$ is called *the extrapolation space*. The *extrapolated semigroup* $(T_{-1}(t))_{t \geq 0}$ is the unique continuous extension of $(T_0(t))_{t \geq 0}$ to X_{-1} , since

$$\|T_0(t)x\|_{-1} = \|T_0(t)R(\lambda_0, A_0)x\| \leq Me^{\omega t}\|x\|_{-1}, \quad t \geq 0, x \in X_0.$$

It is strongly continuous and we denote by $(A_{-1}, D(A_{-1}))$ its generator. We have the following properties (see [186, Prop. 1.3, Thm. 1.4]).

Theorem 4 *We have the following:*

- (a) $\|T_{-1}(t)\|_{\mathcal{L}(X_{-1})} = \|T_0(t)\|_{\mathcal{L}(X_0)}$, $t \geq 0$.
- (b) $D(A_{-1}) = X_0$.
- (c) $A_{-1} : X_0 \rightarrow X_{-1}$ is the unique continuous extension of A_0 .
- (d) X is continuously embedded in X_{-1} and $R(\lambda, A_{-1})$ is an extension of $R(\lambda, A)$ for $\lambda \in \rho(A_{-1}) = \rho(A)$.

- (e) A_0 and A are the parts of A_{-1} in X_0 and X , respectively.
- (f) $R(\lambda_0, A_{-1})X_0 = D(A_0)$.

The following result, concerning the convolutions of $(T_{-1}(t))_{t \geq 0}$ and X -valued locally integrable functions, is one of the fundamental results of the extrapolation theory, and is the key to show the next theorem. For the proof, see [63].

Proposition 5 *Let $f \in L^1_{loc}(\mathbb{R}_+, X)$. Then,*

- (i) *for all $t \geq s \geq 0$, $\int_s^t T_{-1}(t-r)f(r) dr \in X_0$ and*

$$\| \int_s^t T_{-1}(t-r)f(r) dr \| \leq M_1 \int_s^t e^{\omega(t-r)} \|f(r)\| dr, \tag{2.2}$$

M_1 is a constant independent of t and f . For contraction semigroups $(T_0(t))_{t \geq 0}$, $M_1 = 1$ and $\omega = 0$.

- (ii) *The function $[0, +\infty) \ni t \mapsto \int_0^t T_{-1}(t-s)f(s)ds \in X_0$ is continuous.*

We end this section by a non-autonomous perturbation result of Hille-Yosida operators, due to A. Rhandi [199]. For the aim of this document, we need only a particular version of this result.

First, recall that a family $(U(t, s))_{t \geq s \geq 0}$ of bounded linear operators on X is called *evolution family* if

- (a) $U(t, r)U(r, s) = U(t, s)$ and $U(s, s) = Id$ for $t \geq r \geq s \geq 0$ and
- (b) $\{(t, s) : t \geq s \geq 0\} \ni (t, s) \mapsto U(t, s)x$ is continuous for all $x \in X$.

Consider now a perturbation family $B(\cdot) \in \mathcal{C}_b(\mathbb{R}_+, \mathcal{L}_s(X_0, X))$, i.e., $B(t) \in \mathcal{L}(X_0, X)$ for all $t \geq 0$, and $t \mapsto B(t)x$ is a bounded continuous function on \mathbb{R}_+ for all $x \in X_0$.

For all $t \geq 0$, let $C(t)$ denote the part of the perturbed operator $A + B(t)$ in X_0 . By definition, the operator $C(t)$ is defined by

$$C(t) = A + B(t), \quad D(C(t)) = \{x \in D(A) : Ax + B(t)x \in X_0\}.$$

The proof of the following perturbation result relies on the fundamental Proposition 5.

Theorem 6 *The expansion*

$$U(t, s) = \sum_{n=0}^{\infty} U_n(t, s), \tag{2.3}$$

where

$$U_0(t, s) := T_0(t-s) \text{ and } U_{n+1}(t, s) := \int_s^t T_{-1}(t-\sigma)B(\sigma)U_n(\sigma, s)d\sigma, \quad n \geq 0, \tag{2.4}$$

converges in the uniform operator topology of $\mathcal{L}(X_0)$ uniformly on compact subsets of $\{(t, s) : t \geq s \geq 0\}$ and defines an evolution family on X_0 , satisfying

$$\|U(t, s)\| \leq Me^{(\omega+Mc)(t-s)} \tag{2.5}$$

for $t \geq s \geq 0$ and $c := \sup_{\tau \geq 0} \|B(\tau)\|_{\mathcal{L}(X_0, X)}$.

In addition, $(U(t, s))_{t \geq s \geq 0}$ satisfies the variation of constants formula

$$U(t, s)x = T_0(t-s)x + \int_s^t T_{-1}(t-\sigma)B(\sigma)U(\sigma, s)x \, d\sigma, \quad x \in X_0, t \geq s \geq 0. \tag{2.6}$$

Moreover, if $t \mapsto B(t)x$ is differentiable on \mathbb{R}_+ for all $x \in X_0$ then, for all $x \in D(C(s))$, $t \mapsto U(t, s)x$ is differentiable on $[s, \infty)$, $U(t, s)x \in D(C(t))$ and

$$\frac{d}{dt}U(t, s)x = (A + B(t))U(t, s)x$$

for all $t \geq s$.

In this case we say that the evolution family is generated by the family $(C(t), D(C(t)))_{t \geq 0}$.

In the autonomous case, $B(t) \equiv B$, the operator

$$C = A + B, \quad D(C) = \{x \in D(A) : Ax + Bx \in X_0\} \tag{2.7}$$

generates a C_0 -semigroup $(S(t))_{t \geq 0}$, see [187, Thm. 4.1.5]. From Theorem 6, the semigroup $(S(t))_{t \geq 0}$ is given by the Dyson-Phillips expansion

$$S(t) = \sum_{n=0}^{\infty} S_n(t), \tag{2.8}$$

$$S_0(t) := T_0(t) \text{ and } S_{n+1}(t) := \int_0^t T_{-1}(t-\sigma)BS_n(\sigma)d\sigma, \quad t \geq 0, n \geq 0, \tag{2.9}$$

and satisfies the variation of constants formula

$$S(t)x = T_0(t)x + \int_0^t T_{-1}(t-\sigma)BS(\sigma)x \, d\sigma, \quad t \geq 0, x \in X_0. \tag{2.10}$$

3. Homogeneous Retarded Differential Equations

In this section we apply the extrapolation results from the previous section to solve the homogeneous retarded differential equations

$$(HRDE) \quad \begin{cases} x'(t) = Ax(t) + L(t)x_t, & t \geq s, \\ x_s = \varphi, \end{cases}$$

and study the regularity and the asymptotic behaviour of their solutions. Here, A is a Hille-Yosida operator on a Banach space E . Let $\mathbf{S} := (S_0(t))_{t \geq 0}$ the C_0 -semigroup generated by the part of A in $E_0 := \overline{D(A)}$, and $(S_{-1}^-(t))_{t \geq 0}$ its extrapolated semigroup. $(L(t))_{t \geq 0}$ is a family of bounded linear operators from $\mathcal{C}_r := C([-r, 0], E_0)$ to \overline{E} .

By a (classical) solution of (HRDE), we design a continuously differentiable function $x : [-r, +\infty) \rightarrow E_0$, which satisfies the equation (HRDE), and by a mild solution a continuous function $x : [-r, +\infty) \rightarrow E_0$, satisfying

$$x(t) = \begin{cases} S_0(t-s)\varphi(0) + \int_s^t S_{-1}(t-\sigma)L(\sigma)x_\sigma d\sigma, & t \geq s, \\ \varphi(t-s), & s-r \leq t \leq s. \end{cases} \tag{3.1}$$

To get the purpose of this section, we associate to the equation (HRDE) an equivalent Cauchy problem on the product Banach space $\mathcal{X} := E \times \mathcal{C}_r$

$$(CP)_0 \quad \begin{cases} \mathcal{U}'(t) = \mathcal{A}(t)\mathcal{U}(t), & t \geq s, \\ \mathcal{U}(s) = \begin{pmatrix} 0 \\ \varphi \end{pmatrix}, \end{cases}$$

where, for every $t \geq 0$,

$$\mathcal{A}(t) := \begin{pmatrix} 0 & A\delta_0 - \delta'_0 + L(t) \\ 0 & \frac{d}{d\tau} \end{pmatrix},$$

$$D(\mathcal{A}(t)) := \{0\} \times \{ \phi \in C^1([-r, 0], E_0) : \phi(0) \in D(A) \},$$

with δ_0 is the mass of Dirac concentrated at 0, $\delta'_0\varphi := \varphi'(0)$ for all $\varphi \in C^1([-r, 0], E_0)$.

Before showing the equivalence of (HRDE) and $(CP)_0$, we study the well-posedness of the last Cauchy problem $(CP)_0$. To do this, we write the operator $\mathcal{A}(t)$ as the sum of the operator

$$\mathcal{A} := \begin{pmatrix} 0 & A\delta_0 - \delta'_0 \\ 0 & \frac{d}{d\tau} \end{pmatrix},$$

$$D(\mathcal{A}) := \{0\} \times \{\phi \in C^1([-r, 0], E_0) : \phi(0) \in D(A)\},$$

and the operator

$$\mathcal{B}(t) := \begin{pmatrix} 0 & L(t) \\ 0 & 0 \end{pmatrix}, \quad t \geq 0.$$

As we have remarked at the introduction, $\mathcal{X}_0 := \overline{D(\mathcal{A})} = \{0\} \times \mathcal{C}_r$ which means that the operator \mathcal{A} is not densely defined. For this reason, we propose to use the extrapolation theory to study the well-posedness of the Cauchy problem $(CP)_0$.

To this purpose, we need to show that the operator \mathcal{A} is of Hille-Yosida. This result has been shown in [199] when A generates a C_0 -semigroup.

Lemma 7 *The operator \mathcal{A} is of Hille-Yosida and*

$$R(\lambda, \mathcal{A})^n \begin{pmatrix} y \\ \varphi_n \end{pmatrix} = \begin{pmatrix} 0 \\ \varphi_n \end{pmatrix},$$

with

$$\varphi_n(\tau) = \sum_{i=0}^{n-1} e^{\lambda\tau} \frac{(-\tau)^i}{i!} R(\lambda, A)^{n-i} [y + g(0)] + \frac{1}{(n-1)!} \int_{\tau}^0 (\sigma - \tau)^{n-1} e^{\lambda(\tau-\sigma)} g(\sigma) d\sigma \tag{3.2}$$

for all $\tau \in [-r, 0]$, $y \in E$, $g \in \mathcal{C}_r$ and $n \geq 1$.

Proof. From the equation $(\lambda - \mathcal{A}) \begin{pmatrix} 0 \\ \varphi_1 \end{pmatrix} = \begin{pmatrix} y \\ 0 \end{pmatrix}$ on the space \mathcal{X} , we have

$$\varphi_1(\tau) = e^{\lambda\tau} \varphi_1(0) + \int_{\tau}^0 e^{\lambda(\tau-\sigma)} g(\sigma) d\sigma, \quad \tau \in [-r, 0],$$

and

$$A\varphi_1(0) - \varphi_1'(0) = y.$$

We conclude that

$$\varphi_1(\tau) = e^{\lambda\tau} R(\lambda, A)[y + g(0)] + \int_{\tau}^0 e^{\lambda(\tau-\sigma)} g(\sigma) d\sigma, \quad \tau \in [-r, 0].$$

It is clear that the function φ_1 belongs to \mathcal{C}_r , and the relation (3.2) is satisfied for $n = 1$. By induction, we obtain

$$\begin{aligned} \varphi_n(\tau) = & \sum_{i=0}^{n-1} e^{\lambda\tau} \frac{(-\tau)^i}{i!} R(\lambda, A)^{n-i} [y + g(0)] + \frac{1}{(n-1)!} \\ & \int_{\tau}^0 (\sigma - \tau)^{n-1} e^{\lambda(\tau-\sigma)} g(\sigma) d\sigma, \quad \tau \in [-r, 0]. \end{aligned}$$

Since A is a Hille-Yosida operator, it follows that

$$\begin{aligned} \|\varphi_n(\tau)\| &\leq \frac{M}{(\lambda - \omega)^n} \|y\| e^{\lambda\tau} \sum_{i=0}^{n-1} \frac{[(-\lambda + \omega)\tau]^i}{i!} + \\ &\|g\| \left[\frac{M}{(\lambda - \omega)^n} e^{\lambda\tau} \sum_{i=0}^{n-1} \frac{[(-\lambda + \omega)\tau]^i}{i!} + \frac{M}{(n-1)!} \right. \\ &\left. \int_{\tau}^0 (-\sigma)^{n-1} e^{\sigma(\lambda-\omega)} d\sigma \right] \\ &\leq \frac{M}{(\lambda - \omega)^n} [\|y\| + \|g\|]. \end{aligned}$$

The last inequality comes from

$$\frac{M}{(\lambda - \omega)^n} \sum_{i=0}^{n-1} e^{\lambda\tau} \frac{[(-\lambda + \omega)\tau]^i}{i!} + \frac{M}{(n-1)!} \int_{\tau}^0 (\sigma - \tau)^{n-1} e^{(\lambda-\omega)(\tau-\sigma)} d\sigma = \frac{M}{(\lambda - \omega)^n}$$

for $\tau \in [-r, 0]$. Therefore,

$$\|R(\lambda, \mathcal{A})^n\| \leq \frac{M}{(\lambda - \omega)^n} \quad \text{for all } \lambda > \omega, n \geq 1,$$

and this achieve the proof. ■

The part of \mathcal{A} in \mathcal{X}_0 is the operator

$$\begin{aligned} \mathcal{A}_0 = \begin{pmatrix} 0 & 0 \\ 0 & \frac{d}{d\tau} \end{pmatrix}, \quad D(\mathcal{A}_0) = \{0\} \times \{ \phi \in C^1([-r, 0], E_0) : \phi(0) \\ \in D(A); \varphi'(0) = A\varphi(0) \}, \end{aligned}$$

and it generates a C_0 -semigroup $(\mathcal{T}_0(t))_{t \geq 0}$, by Proposition 1. It is clear then that the operator

$$A_0 := \frac{d}{d\tau}, \quad D(A_0) := \{ \phi \in C^1([-r, 0], E_0) : \phi(0) \in D(A); \varphi'(0) = A\varphi(0) \}$$

generates also a C_0 -semigroup $(T_0(t))_{t \geq 0}$, and one can easily show that it is given by

$$(T_0(t)\varphi)(\theta) = \begin{cases} \varphi(t + \theta), & t + \theta \leq 0, \\ S_0(t + \theta)\varphi(0), & t + \theta > 0. \end{cases} \tag{3.3}$$

Hence as \mathcal{A}_0 is a diagonal matrix operator, we have

$$\mathcal{T}_0(t) = \begin{pmatrix} I & 0 \\ 0 & T_0(t) \end{pmatrix}, \quad t \geq 0.$$

To study now the existence of classical solution of (HRDE), we assume:

(H) For all $\varphi \in \mathcal{C}_r$, the function $t \mapsto L(t)\varphi$ is continuously differentiable.

The linear operators $\mathcal{B}(t), t \geq 0$, are bounded from \mathcal{X}_0 into \mathcal{X} and from **(H)**, the functions $t \mapsto \mathcal{B}(t) \begin{pmatrix} 0 \\ \varphi \end{pmatrix}, \varphi \in \mathcal{C}_r$, are continuously differentiable. Thus, by the perturbation result, Theorem 6, the family of the parts of operators $(\mathcal{A} + \mathcal{B}(t))$ in \mathcal{X}_0 generates an evolution family $(\mathcal{U}(t, s))_{t \geq s \geq 0}$ on \mathcal{X}_0 given by the Dyson-Phillips expansion

$$\mathcal{U}(t, s) = \sum_{n=0}^{\infty} \mathcal{U}_n(t, s), \tag{3.4}$$

where

$$\mathcal{U}_0(t, s) := \mathcal{T}_0(t-s) \text{ and } \mathcal{U}_{n+1}(t, s) := \int_s^t \mathcal{T}_{-1}(t-\sigma)\mathcal{B}(\sigma)\mathcal{U}_n(\sigma, s)d\sigma, n \geq 0, \tag{3.5}$$

and which satisfies the variation of constants formula

$$\mathcal{U}(t, s) \begin{pmatrix} 0 \\ \varphi \end{pmatrix} = \left(\mathcal{T}_0(t-s)\varphi \right) + \int_s^t \mathcal{T}_{-1}(t-\sigma)\mathcal{B}(\sigma)\mathcal{U}(\sigma, s) \begin{pmatrix} 0 \\ \varphi \end{pmatrix} d\sigma \tag{3.6}$$

for all $t \geq s$ and $\varphi \in \mathcal{C}_r$.

One can see also that, for each $t \geq 0$, the part of the operator $(\mathcal{A} + \mathcal{B}(t))$ in \mathcal{X}_0 is the operator

$$(\mathcal{A} + \mathcal{B}(t))_{/\mathcal{X}_0} = \begin{pmatrix} 0 & 0 \\ 0 & \frac{d}{d\tau} \end{pmatrix},$$

with the domain

$$\begin{aligned} D((\mathcal{A} + \mathcal{B}(t))_{/\mathcal{X}_0}) &= \{0\} \times \{ \phi \in C^1([-r, 0], E_0) : \phi(0) \in D(A); \varphi'(0) \\ &= A\varphi(0) + L(t)\varphi \}. \end{aligned}$$

Therefore, by identification of the elements of \mathcal{X}_0 and those of \mathcal{C}_r , we get the following result.

Proposition 8 *Assume that **(H)** hold. The family $(A_L(t), D(A_L(t)))_{t \geq 0}$ of operators defined by*

$$\begin{aligned} A_L(t) := \frac{d}{d\tau}, \quad D(A_L(t)) : &= \{ \phi \in C^1([-r, 0], E_0) : \phi(0) \in D(A); \varphi'(0) \\ &= A\varphi(0) + L(t)\varphi \} \end{aligned}$$

generates an evolution family $(U(t, s))_{t \geq s \geq 0}$ on the space \mathcal{C}_r , which satisfies the variation of constants formula

$$U(t, s)\varphi = \mathcal{T}_0(t-s)\varphi + \lim_{\lambda \rightarrow \infty} \int_s^t \mathcal{T}_0(t-\sigma)e^{\lambda R(\lambda, A)}L(\sigma)U(\sigma, s)\varphi d\sigma, \quad t \geq s, \tag{3.7}$$

and is given by the Dyson-Phillips series

$$U(t, s) = \sum_{n=0}^{\infty} U_n(t, s), \tag{3.8}$$

where

$$\begin{aligned} U_0(t, s) &= T_0(t - s) \text{ and } U_{n+1}(t, s) \\ &= \lim_{\lambda \rightarrow \infty} \int_s^t T_0(t - \sigma) e^{\lambda R(\lambda, A)} L(\sigma) U_n(\sigma, s) d\sigma, \quad n \geq 0, t \geq s. \end{aligned} \tag{3.9}$$

Proof. As the operators $(\mathcal{A} + \mathcal{B}(t))_{/\mathcal{X}_0}$, $t \geq 0$, are diagonal matrix operators on $\mathcal{X}_0 = \{0\} \times \mathcal{C}_r$, we can show that

$$\mathcal{U}(t, s) \begin{pmatrix} 0 \\ \varphi \end{pmatrix} = \begin{pmatrix} 0 \\ U(t, s)\varphi \end{pmatrix} \quad \text{for all } t \geq s \text{ and } \varphi \in \mathcal{C}_r,$$

and $(U(t, s))_{t \geq s \geq 0}$ is an evolution family on the space \mathcal{C}_r generated by $(A_L(t), D(A_L(t)))_{t \geq 0}$.

By the variation of constants formula (3.6) and extrapolation results, we obtain that

$$\begin{aligned} \begin{pmatrix} 0 \\ U(t, s)\varphi \end{pmatrix} &= \begin{pmatrix} 0 \\ T_0(t-s)\varphi \end{pmatrix} + \lim_{\lambda \rightarrow \infty} \lambda R(\lambda, \mathcal{A}) \int_s^t \mathcal{T}_{-1}(t - \sigma) \mathcal{B}(\sigma) \mathcal{U}(\sigma, s) \begin{pmatrix} 0 \\ \varphi \end{pmatrix} d\sigma \\ &= \begin{pmatrix} 0 \\ T_0(t-s)\varphi \end{pmatrix} + \lim_{\lambda \rightarrow \infty} \int_s^t T_0(t - \sigma) \lambda R(\lambda, \mathcal{A}) \begin{pmatrix} L(\sigma)U_0(\sigma, s)\varphi \end{pmatrix} d\sigma. \end{aligned}$$

Hence, by Lemma 7 we obtain the variation of constants formula (3.7).

Also by the same argument, from the relations (3.4)-(3.5), we obtain (3.8)-(3.8).

In the following proposition, we give the correspondence between the mild solutions of the retarded equation (HRDE) and those of the Cauchy problem (CP)₀.

Proposition 9 *Let $\varphi \in \mathcal{C}_r$ and $s \geq 0$, we have:*

(i) *The function defined by*

$$x(t, s, \varphi) := \begin{cases} \varphi(t - s), & s - r \leq t \leq s, \\ U(t, s)\varphi(0), & t > s, \end{cases} \tag{3.10}$$

is the mild solution of (HRDE), i.e., x satisfies (3.1). Moreover, it satisfies

$$U(t, s)\varphi = x_t(\cdot, s, \varphi), \quad t \geq s. \tag{3.11}$$

(ii) If $x(\cdot, s, \varphi)$ is the mild solution of (HRDE) then $t \mapsto \begin{pmatrix} 0 \\ x_t(\cdot, s, \varphi) \end{pmatrix}$ is the mild solution of the Cauchy problem (CP)₀, and

$$x_t(\cdot, s, \varphi) = T_0(t-s)\varphi + \lim_{\lambda \rightarrow \infty} \int_s^t T_0(t-\sigma)e^{\lambda \cdot} \lambda R(\lambda, A)L(\sigma)x_\sigma(\cdot, s, \varphi) d\sigma, \quad t \geq s.$$

Proof. Let $\tau \in [-r, 0]$ and $\varphi \in \mathcal{C}_r$. From the extrapolation results, the variation of constants formula (3.7) and the definition of $(T_0(t))_{t \geq 0}$, we have

$$\begin{aligned} U(t, s)\varphi(\tau) &= T_0(t-s)\varphi(\tau) + \lim_{\lambda \rightarrow \infty} \int_s^t T_0(t-\sigma)e^{\lambda \cdot} \lambda R(\lambda, A)L(\sigma)U(\sigma, s)\varphi d\sigma + \\ &= \begin{cases} S_0(t-s+\tau)\varphi(0) + \lim_{\lambda \rightarrow \infty} \int_s^{t+\tau} S_0(t+\tau-\sigma)\lambda R(\lambda, A)L(\sigma)U(\sigma, s)\varphi d\sigma + \\ + \lim_{\lambda \rightarrow \infty} \int_{t+\tau}^t e^{\lambda(t+\tau-s)} \lambda R(\lambda, A)L(\sigma)U(\sigma, s)\varphi d\sigma & \text{if } t-s+\tau > 0, \\ \varphi(t-s+\tau) + \lim_{\lambda \rightarrow \infty} \int_s^t e^{\lambda(t+\tau-s)} \lambda R(\lambda, A)L(\sigma)U(\sigma, s)\varphi ds & \text{if } t-s+\tau \leq 0, \end{cases} \\ &= \begin{cases} S_0(t-s+\tau)\varphi(0) + \int_s^{t+\tau} S_{-1}(t+\tau-\sigma)L(\sigma)U(\sigma, s)\varphi d\sigma & \text{if } t-s+\tau > 0, \\ \varphi(t-s+\tau) & \text{if } t-s+\tau \leq 0 \end{cases} \end{aligned} \tag{3.12}$$

for all $\tau \in [-r, 0]$ and $0 \leq s \leq t$. Let the function

$$x(t, s, \varphi) := \begin{cases} \varphi(t-s), & s-r \leq t \leq s, \\ U(t, s)\varphi(0), & t > s. \end{cases}$$

Hence,

$$x(t, s, \varphi) = S_0(t-s)\varphi(0) + \int_s^{t-s} S_{-1}(t-\sigma)L(\sigma)U(\sigma, s)\varphi d\sigma.$$

From the equality (3.12), one can obtain easily the relation (3.11). Thus, this implies that $x(\cdot, s, \varphi)$ satisfies (3.1), and the assertion (i) is proved. The assertion (ii) can also be deduced from the above relations. ■

In the particular case of autonomous retarded differential equations, i.e. $L(t) = L$ for all $t \geq 0$, we have the following theorem. The part (a) has been obtained also by many authors, e.g., [1], [63], [105] and [253].

Theorem 10 (a) *The operator*

$$A_L := \frac{d}{d\tau}, \quad D(A_L) := \left\{ \varphi \in C^1([-r, 0], E_0) : \varphi(0) \in D(A); \varphi'(0) = A\varphi(0) + L\varphi \right\}$$

generates a strongly continuous C_0 -semigroup $\mathbf{T} := (T(t))_{t \geq 0}$ on the space \mathcal{C}_r .

Moreover, one has:

(i) the solution x of (HRDE) is given by

$$x(t) := \begin{cases} \varphi(t), & -r \leq t \leq 0, \\ T(t)\varphi(0), & t \geq 0. \end{cases} \tag{3.13}$$

(ii) If x is the solution of (HRDE), the semigroup \mathbf{T} is given by

$$T(t)\varphi = x_t \quad \text{for all } \varphi \in \mathcal{C}_r \text{ and } t \geq 0.$$

(b) The semigroup \mathbf{T} is also given by the Dyson-Phillips series

$$T(t) = \sum_{n=0}^{\infty} T_n(t), \quad t \geq 0,$$

where

$$T_n(t)\varphi := \lim_{\lambda \rightarrow \infty} \int_0^t T_0(t-s)e^{\lambda \cdot} \lambda R(\lambda, A) L T_{n-1}(s)\varphi ds,$$

or

$$T_n(t)\varphi(\tau) = \begin{cases} \int_0^{t+\tau} S_{-1}(t+\tau-s) L T_{n-1}(s)\varphi ds & \text{if } t+\tau > 0, \\ 0 & \text{if } t+\tau \leq 0 \end{cases} \tag{3.14}$$

for all $\varphi \in \mathcal{C}_r$ and $n \geq 1, t \geq 0$.

Proof. The part of $\mathcal{A} + \mathcal{B}$ in $\mathcal{X}_0 = \{0\} \times \mathcal{C}_r$ is the operator given by

$$(\mathcal{A} + \mathcal{B})_{/\mathcal{X}_0} = \begin{pmatrix} 0 & 0 \\ 0 & \frac{d}{dt} \end{pmatrix},$$

$$D((\mathcal{A} + \mathcal{B})_{/\mathcal{X}_0}) = \{0\} \times \left\{ \phi \in C^1([-r, 0], E_0) : \phi(0) \in D(A); \phi'(0) = A\phi(0) + L\varphi \right\}.$$

From Section 2, the operator $(\mathcal{A} + \mathcal{B})_{/\mathcal{X}_0}$ generates a C_0 -semigroup $\mathcal{T} := (\mathcal{T}(t))_{t \geq 0}$. Hence, from the form of $(\mathcal{A} + \mathcal{B})_{/\mathcal{X}_0}$, one can see that the operator $(A_L, D(A_L))$ generates also a C_0 -semigroup $\mathbf{T} := (T(t))_{t \geq 0}$ on \mathcal{C}_r , and

$$\mathcal{T}(t) = \begin{pmatrix} I & 0 \\ 0 & T(t) \end{pmatrix}, \quad t \geq 0.$$

Moreover, \mathcal{T} is given by the Dyson-Phillips series

$$\mathcal{T}(t) = \sum_{n=0}^{\infty} \mathcal{T}_n(t), \quad t \geq 0,$$

where

$$\mathcal{T}_n(t)\binom{0}{\varphi} := (\mathcal{T}_n(t)\varphi) := \int_0^t \mathcal{T}_{-1}(t-s)\mathcal{B}\mathcal{T}_{n-1}(s)\binom{0}{\varphi} ds, \quad t \geq 0.$$

From this and Lemma 7, one can see easily as in the non-autonomous case that

$$\mathcal{T}_n(t)\varphi = \lim_{\lambda \rightarrow \infty} \int_0^t T_0(t-s)e^{\lambda \cdot} \lambda R(\lambda, A) L T_{n-1}(s)\varphi ds,$$

and from (3.3), for $\tau \in [-r, 0]$, we have

$$\mathcal{T}_n(t)\varphi(\tau) = \begin{cases} \lim_{\lambda \rightarrow \infty} \int_0^{t+\tau} S_0(t+\tau-s)\lambda R(\lambda, A) L T_{n-1}(s)\varphi ds + \\ + \lim_{\lambda \rightarrow \infty} \int_{t+\tau}^t e^{\lambda(t+\tau-s)} \lambda R(\lambda, A) L T_{n-1}(s)\varphi ds & \text{if } t+\tau > 0, \\ \lim_{\lambda \rightarrow \infty} \int_0^t e^{\lambda(t+\tau-s)} \lambda R(\lambda, A) L T_{n-1}(s)\varphi ds & \text{if } t+\tau \leq 0. \end{cases}$$

Thus, we obtain the relation (3.14). The assertions (i)-(ii) are particular cases of Proposition 9. ■

The Dyson-Phillips series obtained in the above theorem will be now used to study the regularity properties of the semigroup \mathbf{T} solution of the retarded equation (HRDE). As, the terms T_n of the series, see (3.14), are convolutions between the extrapolated semigroup $(S_{-1}(t))_{t \geq 0}$ and E -valued functions, to get our aim, we need the following results.

Lemma 11 [17] *Let $G \in C(\mathbb{R}_+, \mathcal{L}_s(C_r))$. Then,*

(i) *If $\{t : t > 0\} \ni t \mapsto S_0(t) \in \mathcal{L}(E_0)$ is continuous (or \mathbf{S} is immediately norm continuous) then $\{t : t > 0\} \ni t \mapsto \int_0^t S_{-1}(t-s)LG(s) ds \in \mathcal{L}(C_r, E_0)$ is continuous.*

(ii) *If the operator $S_0(t)$ is compact for all $t > 0$ (or \mathbf{S} is immediately compact) then the operator*

$$\int_0^t S_{-1}(t-s)LG(s) ds$$

defined from C_r to E_0 is compact for all $t \geq 0$.

Now, we can announce the following regularity results, showed also, for instance, in [1], [63] and [253].

Theorem 12 (i) *If \mathbf{S} is immediately norm continuous then $\{t : t > r\} \ni t \mapsto T(t) \in \mathcal{L}(C_r)$ is also a continuous function.*

(ii) *If \mathbf{S} is immediately compact then $T(t)$ is also compact for all $t > r$.*

Proof. By the definition of the semigroup $(T_0(t))_{t \geq 0}$ it is easy to show that $t \mapsto T_0(t)$ is norm continuous for $t > r$ if we consider (i), and that the operator $T_0(t)$ is compact for all $t > r$ in the case of (ii).

Assume that \mathbf{S} is immediately norm continuous. From the relations (3.14) and Lemma 11 (i), the function $\mathbb{R}_+ \ni t \mapsto T_n(t) \in \mathcal{L}(\mathcal{C}_r)$ is continuous for all $n \geq 1$. We have seen in Theorem 10 that

$$T(t) = \sum_{n=0}^{\infty} T_n(t) = T_0(t) + \sum_{n=1}^{\infty} T_n(t), \quad t \geq 0, \tag{3.15}$$

and that this series converge in $\mathcal{L}(\mathcal{C}_r)$ uniformly in compact intervals of \mathbb{R}_+ . Hence, the assertion (i) is obtained.

Treat now the assertion (ii). Let $t > 0$ and $n \geq 1$. From Lemma 11, we have that

$$\int_0^{t+\theta} S_{-1}(t+\theta-s)LT_{n-1}(s) ds$$

is a compact operator from \mathcal{C}_r to E_0 for all $t+\theta \geq 0$, and then $T_n(t)(\theta)$ is also a compact operator from \mathcal{C}_r to E_0 for all $\theta \in [-r, 0]$.

By [63, Theorem II.4.29], we have also that \mathbf{S} is immediately norm continuous. Hence, by Lemma 11 (i), the set of functions $\{\theta \mapsto \int_0^{t+\theta} S_{-1}(t+\theta-s)LT_{n-1}(s)\varphi ds \mid \varphi \text{ in some bounded set of } \mathcal{C}_r\}$ is equicontinuous, and then the subset $\{\theta \mapsto T_n(t)(\theta) \mid \varphi \text{ in some bounded set of } \mathcal{C}_r\}$ of \mathcal{C}_r is equicontinuous. The compactness of $T_n(t)$ for all $t > 0$ and $n \geq 1$ follows finally from Arzela-Ascoli theorem. Consequently, as the series (3.15) converges in the uniform operator topology of \mathcal{C}_r , we obtain the second assertion. ■

We end this section by studying the robustness of the asymptotic behaviour of the solutions to non-autonomous retarded equation (HRDE) with respect to the term retard. More precisely, we show that the solution of (HRDE) $\mathbb{R}_+ \ni t \mapsto x(t)$ has the same asymptotic behaviour, e.g., boundedness, asymptotic almost periodicity, as the map $\mathbb{R}_+ \ni t \mapsto S_0(t)\varphi(0)$.

First, let us recall the following definitions:

For a function $f \in BUC(\mathbb{R}_+, X_0)$, the space of bounded and uniformly continuous functions from \mathbb{R}_+ into X_0 , the set of all translates, called the hull of f , is $H(f) := \{f(\cdot + t) : t \in \mathbb{R}_+\}$.

The function f is said to be *asymptotically almost periodic* if $H(f)$ is relatively compact in $BUC(\mathbb{R}_+, X_0)$, and *Eberlein weakly asymptotically almost periodic* if $H(f)$ is weakly relatively compact in $BUC(\mathbb{R}_+, X_0)$, see [129] for more details.

A closed subspace \mathcal{E} of $BUC(\mathbb{R}_+, X_0)$ is said to be translation bi-invariant if for all $t \geq 0$

$$f \in \mathcal{E} \iff f(\cdot + t) \in \mathcal{E},$$

and *operator invariant* if $M \circ f \in \mathcal{E}$ for every $f \in \mathcal{E}$ and $M \in \mathcal{L}(X_0)$, where $M \circ f$ is defined by $(M \circ f)(t) = M(f(t))$, $t \geq 0$.

The closed subspace \mathcal{E} is said to be *homogeneous* if it is translation bi-invariant and operator invariant.

For our purpose, we assume that:

(H1) the C_0 -semigroup $(S_0(t))_{t \geq 0}$ is of contraction,

(H2) there exist $s_0 \geq 0$ and a constant $0 \leq q < 1$ such that

$$\int_0^\infty \|L(s+t)T_0(t)\varphi\| dt \leq q\|\varphi\| \text{ for all } \varphi \in \mathcal{C}_r \text{ and } s \geq s_0. \quad (3.16)$$

Under the above hypotheses, we have the following results.

Proposition 13 (i) For all $\varphi \in \mathcal{C}_r$, $n \in \mathbb{N}$ and $t \geq s \geq s_0$

$$\int_s^{+\infty} \|L(\sigma)U_n(\sigma, s)\varphi\| d\sigma \leq q^{n+1}\|\varphi\| \quad (3.17)$$

and

$$\|U_n(t, s)\varphi\| \leq q^n\|\varphi\|. \quad (3.18)$$

(ii) The series (3.8) converges uniformly on all the set $\{(t, s) : t \geq s \geq s_0\}$. Moreover, the evolution family $(U(t, s))_{t \geq s \geq s_0}$ is uniformly bounded and

$$\|U(t, s)\| \leq \frac{1}{1-q} \text{ for all } t \geq s \geq s_0.$$

Proof.

Let $\varphi \in \mathcal{C}_r$ and $t \geq s \geq s_0$. For $n = 0$, the estimate (3.17) is only our assumption (3.16). Suppose now that the estimate holds for $n - 1$. From the relation (3.8), by using Fubini's theorem we have

$$\begin{aligned}
 & \int_s^t \|L(\sigma)U_n(\sigma, s)\varphi\|d\sigma \\
 &= \int_s^t \|L(\sigma) \lim_{\lambda \rightarrow \infty} \int_s^\sigma T_0(\sigma - \tau)e^{\lambda R(\lambda, A)}L(\tau)U_{n-1}(\tau, s)\varphi d\tau\| d\sigma \\
 &\leq \lim_{\lambda \rightarrow \infty} \int_s^t \left\| \int_s^\sigma L(\sigma)T_0(\sigma - \tau)e^{\lambda R(\lambda, A)}L(\tau)U_{n-1}(\tau, s)\varphi\|d\tau d\sigma \\
 &= \lim_{\lambda \rightarrow \infty} \int_s^t \int_0^{t-\tau} \|L(\sigma + \tau)T_0(\sigma)e^{\lambda R(\lambda, A)}L(\tau)U_{n-1}(\tau, s)\varphi\|d\sigma d\tau.
 \end{aligned}$$

Hence, from (H1), the inequality (3.16) and the induction hypothesis

$$\begin{aligned}
 \int_s^t \|L(\sigma)U_n(\sigma, s)\varphi\|d\sigma &\leq q \int_s^t \|L(\tau)U_{n-1}(\tau, s)\varphi\|d\tau \\
 &\leq q^{n+1}\|\varphi\|,
 \end{aligned}$$

and this gives the estimate (3.17).

The inequality (3.18) follows also from (H1), the relation (3.8) and the first estimate (3.17).

The assertion (ii) follows then by this estimate (3.18). ■

In the above proposition we obtain the boundedness of the evolution family $(U(t, s))_{t \geq s \geq 0}$, and thus from (3.13), the boundedness of the mild solution of (HRDE) is also obtained. To obtain the asymptotic almost periodicity, and other asymptotic properties of this mild solution we need the following Lemma.

Lemma 14 *Let $g \in L^1(\mathbb{R}_+, E)$. If $t \mapsto T_0(t)\varphi$ belongs to \mathcal{E} for all $\varphi \in \mathcal{C}_\tau$ then the function*

$$\mathbb{R}_+ \ni t \mapsto T_0 * g(t) := \lim_{\lambda \rightarrow \infty} \int_0^t T_0(t - \tau)e^{\lambda R(\lambda, A)}g(\tau)d\tau$$

belongs to \mathcal{E} .

Proof. For $g \in L^1(\mathbb{R}_+, E)$, since $(T_0(t))_{t \geq 0}$ is bounded, it is clear that

$$\left\| \lim_{\lambda \rightarrow \infty} \int_0^t T_0(t - \tau)e^{\lambda R(\lambda, A)}g(\tau)d\tau \right\| \leq C\|g\|_{L^1},$$

which implies that for every $g \in L^1(\mathbb{R}_+, E)$, $T_0 * g \in BC(\mathbb{R}_+, \mathcal{C}_r)$ and the linear operator $g \mapsto T_0 * g$ is bounded from $L^1(\mathbb{R}_+, E)$ into $BC(\mathbb{R}_+, \mathcal{C}_r)$, the space of all bounded continuous functions. By this boundedness, the linearity and the density, it is sufficient to show this result for simple functions. Let $g := 1_{(a,b)} \otimes x$, $b \geq a \geq 0$, $x \in E$ and $t \geq 0$. We have,

$$\begin{aligned} T_0 * g(t + b) &= \lim_{\lambda \rightarrow \infty} \int_a^b T_0(t + b - \tau) e^{\lambda \cdot} \lambda R(\lambda, A) x \, d\tau \\ &= T_0(t) \lim_{\lambda \rightarrow \infty} \int_a^b T_0(b - \tau) e^{\lambda \cdot} \lambda R(\lambda, A) x \, d\tau. \end{aligned}$$

Hence, since \mathcal{E} is translation bi-invariant and $t \mapsto T_0(t)\varphi$ belongs to \mathcal{E} for every $\varphi \in \mathcal{C}_r$, we conclude that $T_0 * g(\cdot) \in \mathcal{E}$, and this achieves the proof. ■

We can now state the following main asymptotic behaviour result.

Theorem 15 *Assume that (H1) and (H2) hold. If $t \mapsto T_0(t)\varphi$ belongs to \mathcal{E} for all $\varphi \in \mathcal{C}_r$, and the condition (3.16) is satisfied then, the \mathcal{C}_r -valued function $\mathbb{R}_+ \ni t \mapsto x_{t+s}(\cdot, s, \varphi)$ is also in \mathcal{E} for all $\varphi \in \mathcal{C}_r$ and $s \geq 0$, where $x(\cdot, s, \varphi)$ is the mild solution of (HRDE).*

Proof. From Proposition 9 and the relation (3.11), we have

$$x_{t+s}(\cdot, s, \varphi) = T_0(t)\varphi + \lim_{\lambda \rightarrow \infty} \int_0^t T_0(t - \sigma) e^{\lambda \cdot} \lambda R(\lambda, A) L(s + \sigma) U(s + \sigma, s) \varphi \, d\sigma, \quad t \geq 0. \tag{3.19}$$

As $t \mapsto T_0(t)\varphi$ belongs to \mathcal{E} , it is sufficient to show that the function f from \mathbb{R}_+ to \mathcal{C}_r

$$f(t) := \lim_{\lambda \rightarrow \infty} \int_0^t T_0(t - \sigma) e^{\lambda \cdot} \lambda R(\lambda, A) L(s + \sigma) U(s + \sigma, s) \varphi \, d\sigma, \quad t \geq 0$$

belongs to \mathcal{E} as well. Furthermore, by Lemma 14, it is sufficient to show that the function $g(\cdot) := L(\cdot + s)U(\cdot + s, s)\varphi$ belongs to $L^1(\mathbb{R}_+, E)$, and this follows from (3.8) and the estimate (3.17) for all $s \geq s_0$. Hence, the function $\mathbb{R}_+ \ni t \mapsto x_{t+s}(\cdot, s, \varphi) = U(t + s, s)\varphi$ belongs to \mathcal{E} for all $s \geq s_0$ and $\varphi \in \mathcal{C}_r$.

For all $s \geq 0$ and $t \geq 0$, one can write

$$U(t + s_0 + s, s)\varphi = U(t + s + s_0, s + s_0)U(s + s_0, s)\varphi.$$

As $s + s_0 \geq s_0$, then as shown above $t \mapsto U(t + s_0 + s, s + s_0)\varphi$ belongs to \mathcal{E} and by the translation bi-invariance of \mathcal{E} , $t \mapsto x_{t+s}(\cdot, s, \varphi) = U(t + s, s)\varphi$ belongs to \mathcal{E} . This achieves the proof. ■

The C_0 -semigroup $(T_0(t))_{t \geq 0}$ is given in terms of the C_0 -semigroup $(S_0(t))_{t \geq 0}$, then we can hope that they have the same asymptotic behaviour. In the following lemma, we present some particular commune asymptotic behaviours to these two semigroups.

Lemma 16 *Let $\varphi \in \mathcal{C}_r$. Assume that the map $\mathbb{R}_+ \ni t \mapsto S_0(t)\varphi(0)$ is*

- (1) *vanishing at infinity, or*
- (2) *asymptotically almost periodic, or*
- (3) *uniformly ergodic, i.e., the limit $\lim_{\alpha \rightarrow 0^+} \alpha \int_0^\infty e^{-\alpha s} S_0(\cdot + s)\varphi(0) ds$ exists and defines an element of $BUC(\mathbb{R}_+, E_0)$, or*
- (4) *totally uniformly ergodic, i.e., the Cesàro limit $\lim_{t \rightarrow +\infty} \frac{1}{t} \int_0^t e^{i\theta s} S_0(\cdot + s)\varphi(0) ds$ exists in $BUC(\mathbb{R}_+, E_0)$ for all $\theta \in \mathbb{R}$.*

Then, the function $\mathbb{R}_+ \ni t \mapsto T_0(t)\varphi$ has the same property in $BUC(\mathbb{R}_+, \mathcal{C}_r)$.

Proof.

As $(S_0(t))_{t \geq 0}$ is a contraction semigroup, we have for all $t > r$ and $\theta \in [-r, 0]$

$$\begin{aligned} \|(T_0(t)\varphi)(\theta)\| &= \|S_0(t + \theta)\varphi(0)\| = \|S_0(r + \theta)S_0(t - r)\varphi(0)\| \\ &\leq \|S_0(t - r)\varphi(0)\|. \end{aligned}$$

If one has (1), then $\|T_0(t)\varphi\| \rightarrow 0$, when $t \rightarrow \infty$.

Assume now that we have (2). By the definition of asymptotic almost periodicity, see [7], for every $\varepsilon > 0$ there is $l(\varepsilon) > 0$ and $K \geq 0$ such that each interval of length $l(\varepsilon)$ contains a τ for which this inequality

$$\|S_0(t + \tau)\varphi(0) - S_0(t)\varphi(0)\| \leq \varepsilon$$

holds for all $t, t + \tau \geq K$. Let now $t > K + r$. Then, one has

$$\begin{aligned} \|(T_0(t + \tau)\varphi)(\theta) - (T_0(t)\varphi)(\theta)\| &= \|S_0(t + \theta + \tau)\varphi(0) - S_0(t + \theta)\varphi(0)\| \\ &\leq \|S_0(t - r + \tau)\varphi(0) - S_0(t - r)\varphi(0)\| \\ &< \varepsilon \quad \text{for all } \theta \in [-r, 0], \end{aligned}$$

and this means that $T_0(\cdot)\varphi$ is asymptotically almost periodic.

The assertions (3) and (4) can be showed by the same technique. ■
As the classes of functions (1)-(4) are particular homogeneous closed subspaces of $BUC(\mathbb{R}_+, \mathcal{C}_r)$, see [22], by Theorem 15 and Lemma 16, we have the following corollary.

Corollary 17 *Assume that (H1) and (H2) hold and that for all $\varphi \in \mathcal{C}_r$ the function*

$\mathbb{R}_+ \ni t \mapsto S_0(t)\varphi(0)$ belongs to one of the classes (1)-(4) of Lemma 16. Then, for all $\varphi \in \mathcal{C}_r$, the mild solution $x(\cdot, 0, \varphi)$ of (HRDE) belongs to the same class.

Example 5 Consider the retarded partial differential equation

$$\begin{cases} u'(t, x) = -\frac{\partial}{\partial x}u(t, x) - \alpha u(t, x) + \int_{-1}^0 K(t, \sigma, x)u(t + \sigma, x) d\sigma, & t \geq 0, x \geq 0, \\ u(t, 0) = 0, & t \geq 0, \\ u(t, x) = \varphi(t, x), & -1 \leq t \leq 0, x \geq 0, \end{cases} \quad (3.20)$$

where $K \in L^\infty(\mathbb{R}_+ \times [-1, 0] \times (0, \infty))$ and $\alpha > 0$. If we set $E := L^1(0, \infty)$, the operators

$$L(t)f := \int_{-1}^0 k(t, \sigma)f(\sigma) d\sigma, \quad t \geq 0,$$

are bounded from $C([-1, 0], E)$ to E . Assume moreover that $\int_0^\infty \|K(t)\|_\infty < \infty$, then $L(\cdot)$ is integrable on \mathbb{R}_+ , and then the condition (3.16) is satisfied for a large s_0 .

For this example, the operator A is defined on E by

$$Af = -\frac{\partial}{\partial x}f - \alpha f, \quad D(A) = \{g \in W^{1,1}(0, \infty) : g(0) = 0\},$$

and it generates the exponentially stable semigroup

$$(T_0(t)f)(a) := \begin{cases} e^{-\alpha t}f(a-t), & a-t \geq 0, \\ 0, & \text{otherwise.} \end{cases}$$

By the above corollary, the solutions of the partial retarded differential equation (3.20) are asymptotically stable.

Chapter 13

TIME DELAYS IN EPIDEMIC MODELS

Modeling and Numerical Considerations

J. Arino

Department of Mathematics,

University of Manitoba, Winnipeg, Manitoba, Canada

arionj@cc.umanitoba.ca

P. van den Driessche

Department of Mathematics and Statistics

University of Victoria BC, Canada

pvdd@math.uvic.ca

1. Introduction

Continuous time deterministic epidemic models are traditionally formulated as systems of ordinary differential equations for the numbers of individuals in various disease states, with the sojourn time in a state being exponentially distributed. Time delays are introduced to model constant sojourn times in a state, for example, the infective or immune state. Models then become delay-differential and/or integral equations. For a review of some epidemic models with delay see van den Driessche [228]. More generally, an arbitrarily distributed sojourn time in a state, for example, the infective or immune state, is used by some authors (see [69] and the references therein).

When introduced in an explicit way, time delays may change the qualitative behavior of a model; for example, an epidemic model with generalized logistic dynamics can have periodic solutions when the time in the infective stage is constant [112]. Qualitative differences that arise from including time delay in an explicit way in models that include vertical transmission are explored in [38, Chapter 4]. In population biology, a maturation time delay is used to explain observed oscillations [192]. This delay is included in an epidemic model by Cooke, van den Driessche and

Zou [47]. A fixed time delay in the recruitment function for a disease model is considered by Brauer [33].

Many disease transmission models with delay are difficult to analyze, with even the linear stability problem reducing to a hard quasi-polynomial; see, *e.g.*, [27, 33] and references therein. Thus a combination of analytical and numerical techniques is often employed.

Here we proceed along the lines of van den Driessche [229], giving details about delay in models of disease transmission by concentrating on one particular model, namely work with two other coauthors, K. L. Cooke and J. Velasco-Hernández [13]. In Section 2, we first motivate the introduction of delay in epidemic models in which this delay results from assumptions on the sojourn time in a certain epidemiological state, *e.g.*, the infective state. We then (in Section 3) formulate a model including vaccination of susceptible individuals in which the vaccine waning time is arbitrarily distributed [13]. In Section 4, we specialize to two particular waning functions, concentrating on the step function case that leads to a system of delay integro-differential equations. Numerics on this system are reported in Section 5 (with program listings in Appendix 1). Some numerical warnings are given in Section 6, and we conclude with an annotated listing of available delay differential equations numerical packages (Appendix 2).

2. Origin of time delays in epidemic models

Various biological reasons lead to the introduction of time delays in models of disease transmission. Here we concentrate on one of the possible origins: the fact that sojourn times in certain states can have a general form, for example, can be approximately constant, as opposed to having an exponential distribution. A formal derivation of this uses probability theory and, in particular, survival analysis. A brief summary of these notions is given in Section 2.1. Then, survival analysis is tied to dynamical models of disease transmission in Section 2.2; see [225] for a more general and more detailed presentation.

2.1 Sojourn times and survival functions

Consider a system that can be in either one of two states A and B . Suppose that at time $t = 0$, the system is in state A . Suppose that when an event \mathcal{E} takes place, the system switches to state B , and call X the (positive) random variable “time spent in state A before switching to state B ”. The cumulative distribution function (c.d.f.) $F(t)$ then characterizes the distribution of X , with $F(t) = \Pr\{X \leq t\}$, and so does the probability distribution function $f(t)$, where $F(t) = \int_0^t f(x)dx$.

Another characterization of the distribution of the random variable X is the *survival* (or *sojourn*) function. The survival function of state A is given by

$$\mathcal{S}(t) = 1 - F(t) = \Pr\{X > t\} \quad (2.1)$$

This function gives a description of the *sojourn time* of a system in a particular state. Note that \mathcal{S} must be a nonincreasing function (since $\mathcal{S} = 1 - F$ with F a c.d.f., thus a nondecreasing function), and $\mathcal{S}(0) = 1$ (since X is a positive random variable).

The *average sojourn time* τ in state A is given by

$$\tau = \int_0^{\infty} t f(t) dt$$

Assuming that $\lim_{t \rightarrow \infty} t \mathcal{S}(t) = 0$ (which is verified for most probability distributions),

$$\tau = \int_0^{\infty} \mathcal{S}(t) dt$$

Suppose that the random variable X has exponential distribution $f(t) = \theta e^{-\theta t}$ for $t \geq 0$, with $\theta > 0$. Then the survival function for state A is of the form $\mathcal{S}(t) = e^{-\theta t}$, for $t \geq 0$, and the average sojourn time in state A is

$$\tau = \int_0^{\infty} e^{-\theta t} dt = \frac{1}{\theta}$$

If on the other hand, for some constant $\omega > 0$,

$$\mathcal{S}(t) = \begin{cases} 1, & 0 \leq t \leq \omega \\ 0, & \omega < t \end{cases}$$

which means that X has a Dirac delta distribution $\delta_{\omega}(t)$, then the average sojourn time is a constant, namely

$$\tau = \int_0^{\omega} dt = \omega$$

These two distributions can be regarded as extremes.

2.2 Sojourn times in an SIS disease transmission model

Consider a particular disease, and suppose that a population of individuals can be identified with respect to their epidemiological status: susceptible to the disease, infected by the disease, recovered from the disease, etc. To illustrate, consider a disease that confers no immunity. This is modeled by a very simple SIS model. Individuals are thus either

susceptible to the disease, with the number of such individuals at time t denoted by $S(t)$, or *infected* by the disease (and are also *infective* in the sense that they propagate the disease), with the number of such individuals at time t denoted by $I(t)$. Suppose for simplicity that there is neither birth nor death. Hence $N \equiv N(t) = S(t) + I(t)$ is the (constant) total population. Infection is assumed to take place following a *standard incidence* pattern (see [181] for a discussion of transmission terms): the number of new infectives resulting from random contacts between susceptible and infective individuals per unit time is given by $\beta SI/N$. Here β is the *transmission coefficient*, it gives the probability of transmission of the disease in case of a contact, times the number of such contacts made by an infective per unit time.

Traditional epidemiological models assume that recovery from disease occurs with a rate constant γ . However, as in [112], the assumption is made here that, of the individuals who have become infective at time t_0 , a fraction $P(t - t_0)$ remain infective at time $t \geq t_0$. Thus, considered for $t \geq 0$, the function $P(t)$ is a survival function. As such, it satisfies the properties given in Section 2.1, and in particular, $P(0) = 1$. The transfer diagram for the system then has the form shown in Figure 13.1.

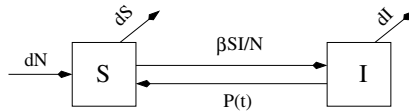

Figure 13.1. The transfer diagram for the SIS model.

Since N is constant, it follows that $S(t) = N - I(t)$ and the model reduces to the following integral equation for the number of infective individuals

$$I(t) = I_0(t) + \int_0^t \beta \frac{(N - I(u))I(u)}{N} P(t - u) du \quad (2.2)$$

Here $I_0(t)$ is the number of individuals who were infective at time $t = 0$ and who still are at time t . It suffices to assume that $I_0(t)$ is nonnegative, nonincreasing, and such that $\lim_{t \rightarrow \infty} I_0(t) = 0$. The term $P(t - u)$ in the integral is the proportion of individuals who became infective at time u and who still are at time t . Multiplying this with the contact term $\beta(N - I(u))I(u)/N$ and summing over $[0, t]$ gives the number of infective individuals at time t .

The two extreme cases for $P(t)$ considered in Section 2.1 illustrate various possibilities. First, suppose that $P(t)$ is such that the sojourn

time in the infective state has an exponential distribution with mean $1/\gamma$, *i.e.*, $P(t) = e^{-\gamma t}$. Then (2.2) is

$$I(t) = I_0(t) + \int_0^t \beta \frac{(N - I(u))I(u)}{N} e^{-\gamma(t-u)} du$$

Taking the time derivative of $I(t)$ yields

$$\begin{aligned} I'(t) &= I'_0(t) - \gamma \int_0^t \beta \frac{(N - I(u))I(u)}{N} e^{-\gamma(t-u)} du + \beta \frac{(N - I(t))I(t)}{N} \\ &= I'_0(t) + \beta \frac{(N - I(t))I(t)}{N} + \gamma (I_0(t) - I(t)) \end{aligned}$$

In this case $I_0(t) = I_0(0)e^{-\gamma t}$, giving

$$I'(t) = \beta \frac{(N - I(t))I(t)}{N} - \gamma I(t)$$

which is the classical logistic type ordinary differential equation (ODE) for I in an SIS model without vital dynamics (see, *e.g.*, [34, p. 289]).

The *basic reproduction number*, denoted by \mathcal{R}_0 , which is a key concept in mathematical epidemiology, is now introduced. It is defined (see, *e.g.*, [12, 58]) as the expected number of secondary cases produced, in a completely susceptible population, by the introduction of a typical infective individual. For this ODE model, $\mathcal{R}_0 = \beta/\gamma$. In terms of stability, the disease free equilibrium (DFE) with $I = 0$ is stable for $\mathcal{R}_0 < 1$ and unstable for $\mathcal{R}_0 > 1$. At the threshold $\mathcal{R}_0 = 1$, there is a forward bifurcation with a stable endemic equilibrium (with $I > 0$) for $\mathcal{R}_0 > 1$. Thus the value of \mathcal{R}_0 determines whether the disease dies out or tends to an endemic value.

The second case corresponds to $P(t)$ being a step function:

$$P(t) = \begin{cases} 1 & \text{if } t \in [0, \omega] \\ 0 & \text{otherwise} \end{cases}$$

i.e., the sojourn time in the infective state is a constant $\omega > 0$. In this case (2.2) becomes

$$I(t) = I_0(t) + \int_{t-\omega}^t \beta \frac{(N - I(u))I(u)}{N} du$$

which when differentiated, gives for $t \geq \omega$

$$I'(t) = I'_0(t) + \beta \frac{(N - I(t))I(t)}{N} - \beta \frac{(N - I(t - \omega))I(t - \omega)}{N}$$

Since $I_0(t)$ vanishes for $t > \omega$, this gives the delay differential equation (DDE)

$$I'(t) = \beta \frac{(N - I(t))I(t)}{N} - \beta \frac{(N - I(t - \omega))I(t - \omega)}{N}$$

cf. [34, Section 7.6] (where the disease transmission is modelled using mass action). Note that every constant value of I is an equilibrium, thus the integral form above gives a better description than the DDE. For this case, $\mathcal{R}_0 = \beta\omega$ again acts as a threshold. For $\mathcal{R}_0 < 1$, the DFE is stable; whereas for $\mathcal{R}_0 > 1$, the endemic equilibrium is locally asymptotically stable [34, Section 7.6].

More realistically, the survival function for the infective state is between an exponential and a step function (see, e.g., [12, 225]), thus the two cases considered above can be regarded as extremes.

3. A model that includes a vaccinated state

We now use the ideas of the previous section in a different setting. Consider a disease for which there exists a vaccine. Suppose that, although there exists a vaccine, we can assume that developing the disease confers no immunity. For example, at a given time, there are several strains of influenza circulating in a given population. Vaccination usually focuses on particular strains, which are expected to be the dominant ones in a particular year. Vaccination gives partial protection from other strains as does contracting the disease. However, this protection is only partial, and some individuals can contract the disease several times. Thus if considered as one single disease, influenza can fit the above description. The assumptions also apply to models in which individuals can be in two groups depending on their transmission coefficients with respect to a given disease. They can move between these groups as education campaigns or policies influence their behavior.

Our model, which is similar to that in [13], has the transfer diagram shown in Figure 13.2. The number of individuals in the *susceptible*, *infective* and *vaccinated* states are given by $S(t)$, $I(t)$, $V(t)$, respectively. As noted above, $V(t)$ may alternatively correspond to an educated state, but we refer to it as vaccinated. Individuals move from one state to the other as their status with respect to the disease evolves. New individuals are born into the susceptible state with a birth rate constant $d > 0$, and all individuals, whatever their status, are subject to death with the same natural death rate constant d . It is assumed that the disease does not cause death, thus the total population $N = S(t) + I(t) + V(t)$ is constant, allowing for the simplification that the number of individuals in the S state is given by $S(t) = N - I(t) - V(t)$. Susceptible individuals are

vaccinated with rate constant ϕ , and enter the V state. Note that the model in [13] further assumes that a fraction of newborns are vaccinated.

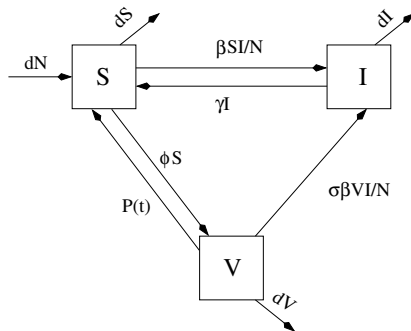

Figure 13.2. The transfer diagram for the SIV model.

As in Section 2.2, disease transmission is assumed to be of standard incidence type, thus susceptibles enter the infective state at a rate $\beta SI/N$, where $\beta > 0$ is the transmission coefficient. In addition, it is assumed that successfully vaccinated individuals may only be partially protected from infection (*i.e.*, the vaccine is leaky). Vaccinated individuals can contract the disease, but vaccination reduces transmission by a factor $\sigma \in [0, 1)$. Thus the number of new infectives produced by random contacts between I infectives and V vaccinated individuals per unit time is $\sigma\beta SI/N$, and vaccinated individuals enter the infective state at this rate.

Many vaccines wane with time, and so vaccinated individuals return to the susceptible state. In [130], this waning is assumed to be exponential but here we assume a more general waning function $P(t)$. We suppose that, at a given time t , there is a fraction $P(t)$ of the vaccinated individuals who are still under protection of the vaccine t units after being vaccinated. Since the waning function $P(t)$ is a survival function it is assumed to be nonnegative and nonincreasing with $P(0) = 1$, and moreover $\int_0^\infty P(u)du$ is positive and finite. Finally, it is assumed that the infective individuals can be cured, so that members of the I state return to the susceptible state, with rate constant $\gamma \geq 0$ (the *recovery* rate).

Since the total population remains constant, it is more convenient to use proportions (rather than number of individuals) in each state. Hereafter, we use $I(t)$ and $V(t)$ to denote the proportion of infective and vaccinated individuals, respectively, with $S(t) = 1 - I(t) - V(t)$, the

proportion of susceptibles. Let the initial susceptible and infective proportions be $S(0) > 0, I(0) > 0$ and let $V_0(t)$ be the proportion of individuals who are initially in the vaccinated state and for whom the vaccine is still effective at time t . With the above assumptions, the following integro-differential system describes the model depicted in Figure 13.2.

$$\frac{dI(t)}{dt} = \beta(1 - I(t) - (1 - \sigma)V(t))I(t) - (d + \gamma)I(t) \tag{3.1a}$$

$$V(t) = V_0(t) + \int_0^t \phi S(u)P(t - u)e^{-d(t-u)}e^{-\sigma\beta \int_u^t I(x)dx} du \tag{3.1b}$$

The integral in (3.1b) sums the proportion of those who were vaccinated at time u and remain in the V state at time t . Specifically, $\phi S(u)$ is the proportion of vaccinated susceptibles, $P(t - u)$ is the fraction of the proportion vaccinated still protected by the vaccine $t - u$ time units after going in (*i.e.*, not returned to S), $e^{-d(t-u)}$ is the fraction of the proportion vaccinated not dead due to natural causes, and $e^{-\sigma\beta \int_u^t I(x)dx}$ is the fraction of the proportion vaccinated not infective (*i.e.*, not progressed to the I state). An expression for $V_0(t)$ can be obtained by formulating the model with vaccination state-age (see, *e.g.*, [13, 112]) as

$$V_0(t) = e^{-\int_0^t (\sigma\beta I(x) + d)dx} \int_0^\infty v(0, u) \frac{P(t + u)}{P(u)} du \tag{3.2}$$

where $v(0, u) \geq 0$ is the density at $t = 0$ of the proportion of individuals in vaccination state-age u ; thus $V_0(0) = \int_0^\infty v(0, u)du$. The above integral converges, and thus $V_0(t)$ is nonnegative, nonincreasing and $\lim_{t \rightarrow \infty} V_0(t) = 0$.

Define the subset \mathcal{D} of the nonnegative orthant by

$$\mathcal{D} = \{(S, I, V); S \geq 0, I \geq 0, V \geq 0, S + I + V = 1\}$$

It is easy to show (see [13]) that the set \mathcal{D} is positively invariant under the flow of (3.1) with $I(0) > 0, S(0) > 0$.

Differentiating (3.1b) gives

$$\frac{d}{dt}V(t) = \frac{d}{dt}V_0(t) + \phi S(t) - (d + \sigma\beta I(t))(V(t) - V_0(t)) + Q(t) \tag{3.3}$$

where

$$Q(t) = \int_0^t \phi S(u)d_t(P(t - u))e^{-d(t-u)}e^{-\sigma\beta \int_u^t I(x)dx} du$$

With the assumed initial conditions in \mathcal{D} , the system defined by (3.1a) and (3.1b) is equivalent to the system defined by (3.1a) and (3.3). This

latter system is of standard form, therefore results of Hale and Verduyn Lunel [105, p. 43] ensure the local existence, uniqueness and continuation of solutions of model (3.1).

Equation (3.1a) has $I = 0$ as an equilibrium and using $I = 0$ in equation (3.1b) as $t \rightarrow \infty$ gives the disease free equilibrium (DFE) as $I_{DFE} = 0$,

$$S_{DFE} = \frac{1}{1 + \phi\tilde{P}}, \quad V_{DFE} = \frac{\phi\tilde{P}}{1 + \phi\tilde{P}}$$

Here

$$\tilde{P} = \lim_{t \rightarrow \infty} \int_0^t P(v)e^{-dv} dv$$

which is the average length of time that an individual remains vaccinated (before losing vaccination protection or dying).

The basic reproduction number with vaccination is defined in terms of \tilde{P} as

$$\mathcal{R}_{vac} = \mathcal{R}_0 \frac{\sigma\phi\tilde{P} + 1}{\phi\tilde{P} + 1} \tag{3.4}$$

in which $\mathcal{R}_0 = \frac{\beta}{d+\gamma}$ is the basic reproduction number with natural death but no vaccination. The number \mathcal{R}_{vac} is the important quantity in this model that includes vaccination; \mathcal{R}_{vac} is equal to the product of the mean infective period $1/(d + \gamma)$ and the sum of the contact rate constant in each of the susceptible and vaccinated states multiplied respectively by the proportion in that state at the DFE, namely $\beta S_{DFE} + \sigma\beta V_{DFE}$. Note that $\mathcal{R}_{vac} \leq \mathcal{R}_0$, and in the case of no vaccination, that is $\phi = 0$, $\mathcal{R}_{vac} = \mathcal{R}_0$.

If $\mathcal{R}_0 < 1$, then the only equilibrium of (3.1a) is $I_{DFE} = 0$, thus the DFE is the only equilibrium of system (3.1) when $\mathcal{R}_0 < 1$. In this case, (3.1a) gives

$$\frac{dI}{dt} < (d + \gamma) ((S + \sigma V) - 1) I$$

which implies that $dI/dt < 0$, and so $I(t) \rightarrow 0 = I_{DFE}$ as $t \rightarrow \infty$, for all initial conditions $I(0) > 0$. Thus the disease dies out if $\mathcal{R}_0 < 1$.

The importance of \mathcal{R}_{vac} can be seen from the following linear stability result.

Theorem 1 *For model (3.1) with a general waning function, if $\mathcal{R}_{vac} < 1$, then the DFE is locally asymptotically stable (l.a.s.); if $\mathcal{R}_{vac} > 1$, then it is unstable.*

Proof. Linearize (3.1a) and (3.1b) about the DFE, taking $t \rightarrow \infty$. Then the eigenvalues z of the linearized system at the DFE are given by

$$z = \beta(S_{DFE} + \sigma V_{DFE}) - (d + \gamma) = (d + \gamma)(\mathcal{R}_{vac} - 1) \tag{3.5a}$$

and the roots of

$$1 = -\phi \int_0^\infty P(v)e^{-(d+z)v} dv \tag{3.5b}$$

Let $z = x + iy$ be a root of equation (3.5b). Then by the proof of Lemma 2 in [230], if $x \geq 0$, then $y = 0$. But since $\phi \geq 0$, equation (3.5b) has no nonnegative real root, thus all of its roots have negative real parts. Hence, from (3.5a), the DFE is l.a.s if $\mathcal{R}_{vac} < 1$, and unstable if $\mathcal{R}_{vac} > 1$. ■

4. Reduction of the system by using specific $P(t)$ functions

Here we show two examples of models resulting from the choice of specific vaccine waning functions $P(t)$ as the two extreme cases in Section 2.2. The first example (Section 4.1) is obtained when the distribution of waning times is exponential, and leads to the ODE system studied in [130]. As discussed in [130], for some parameter values, there is a *backward bifurcation*, a rather uncommon phenomenon in epidemiological models. This backward bifurcation is also present when the system consists of delay integro-differential equations, such as is the case in Section 4.2 when the waning function is assumed to be a step function corresponding to a constant sojourn time in the vaccinated state.

4.1 Case reducing to an ODE system

Assuming that the vaccine waning rate is a constant $\theta > 0$, *i.e.*, $P(t) = e^{-\theta t}$, then $V_0(t) = V_0(0)e^{-(d+\theta)t} e^{-\int_0^t \sigma\beta I(x)dx}$ from (3.2), equations (3.1a) and (3.3) give the ODE system

$$\frac{dI}{dt} = \beta(1 - I - (1 - \sigma)V)I - (d + \gamma)I \tag{4.1a}$$

$$\frac{dV}{dt} = \phi(1 - I - V) - \sigma\beta IV - (d + \theta)V \tag{4.1b}$$

which is the model studied in [130]. The DFE with $I_{DFE} = 0$,

$$S_{DFE} = \frac{\theta + d}{d + \theta + \phi}, \quad V_{DFE} = \frac{\phi}{d + \theta + \phi}$$

always exists, and from (3.4) the basic reproduction number is

$$\mathcal{R}_{vac} = \mathcal{R}_0 \frac{d + \theta + \sigma\phi}{d + \theta + \phi}$$

Assume that $\mathcal{R}_0 > 1$, then endemic equilibria ($I > 0$) can be obtained analytically from a quadratic equation, and for $\sigma > 0$ (*i.e.*, a leaky vaccine) it is possible to have a backward bifurcation leading to two endemic equilibria for some parameter values. This occurs for a range of \mathcal{R}_{vac} , namely $\mathcal{R}_c < \mathcal{R}_{vac} < 1$ where \mathcal{R}_c is the value of \mathcal{R}_{vac} at the saddle node bifurcation point where the two endemic equilibria coincide; see [130] for details.

4.2 Case reducing to a delay integro-differential system

Assume that the vaccine waning period is constant and equal to $\omega > 0$, that is the function $P(t)$ takes the form of a step function on a finite interval:

$$P(t) = \begin{cases} 1 & \text{if } t \in [0, \omega] \\ 0 & \text{otherwise} \end{cases}$$

Since $S = 1 - I - V$, and $V_0(t) = 0$ for $t > \omega$, the integral equation (3.1b) becomes, for $t > \omega$

$$V(t) = \int_{t-\omega}^t \phi(1 - I(u) - V(u))e^{-d(t-u)}e^{-\sigma\beta \int_u^t I(x)dx} du \tag{4.2}$$

Differentiating this last expression (see equation (3.3)), the model can be written as the two dimensional integro-differential equation system for $t > \omega$

$$\frac{dI(t)}{dt} = \beta(1 - I(t) - (1-\sigma)V(t))I(t) - (d + \gamma)I(t) \tag{4.3a}$$

$$\begin{aligned} \frac{dV(t)}{dt} &= \phi(1 - I(t) - V(t)) - \phi(1 - I(t-\omega) - V(t-\omega))e^{-d\omega}e^{-\sigma\beta \int_{t-\omega}^t I(x)dx} \\ &\quad - \sigma\beta IV - dV \end{aligned} \tag{4.3b}$$

Hereafter, we shift time by ω so that these equations hold for $t > 0$. By introducing a third state variable

$$X(t) = \int_{t-\omega}^t I(x)dx \tag{4.4}$$

which gives $\frac{dX(t)}{dt} = I(t) - I(t - \omega)$, the system can be regarded as a three dimensional DDE system.

For a constant waning period, the basic reproduction number from (3.4) is

$$\mathcal{R}_{vac} = \mathcal{R}_0 \frac{d + \sigma\phi(1 - e^{-d\omega})}{d + \phi(1 - e^{-d\omega})} \tag{4.5}$$

The DFE is $I_{DFE} = 0$,

$$S_{DFE} = \frac{d}{d + \phi(1 - e^{-d\omega})}, \quad V_{DFE} = \frac{\phi(1 - e^{-d\omega})}{d + \phi(1 - e^{-d\omega})} \tag{4.6}$$

Note that the delay ω enters into these equilibrium values. If $\mathcal{R}_0 < 1$, then the system tends to the DFE and the disease dies out (see Section 3). For $\mathcal{R}_0 > 1$, from nullclines, there exists one (or more) (EEP) iff there exists $I^* \in (0, 1]$ such that

$$\frac{1 - 1/\mathcal{R}_0 - I^*}{1 - \sigma} = \frac{\phi(1 - I^*)(1 - e^{-d\omega - \sigma\beta\omega I^*})}{\phi(1 - e^{-d\omega - \sigma\beta\omega I^*}) + d + \sigma\beta I^*} \tag{4.7}$$

5. Numerical considerations

We give some insights into numerical aspects by considering the delay integro-differential model (4.3). First, in Section 5.1 we set up the algorithm that is used to study the occurrence of forward and backward bifurcations at $\mathcal{R}_{vac} = 1$. We use this algorithm in Section 5.2, and investigate the dynamical behavior of system (4.3) by running numerical integrations.

5.1 Visualising and locating the bifurcation

An EEP exists iff there exists an $I^* \in (0, 1]$ such that (4.7) holds. So we study the zeros of

$$H(I) = \frac{1 - 1/\mathcal{R}_0 - I}{1 - \sigma} - \frac{\phi(1 - I)(1 - e^{-d\omega - \sigma\beta\omega I})}{\phi(1 - e^{-d\omega - \sigma\beta\omega I}) + d + \sigma\beta I}$$

Note that $H(0) = \frac{\mathcal{R}_{vac}-1}{(1-\sigma)\mathcal{R}_0}$ and $H(1) < 0$.

Let $\mathcal{A} = \{\beta, d, \gamma, \phi, \omega, \sigma\}$ be the set of parameters of the model. When needed, we denote $H(I, a)$ and $\mathcal{R}_{vac}(a)$, with $a \in \mathcal{A}$ a parameter, to indicate that the bifurcation is considered as a function of this parameter a ; e.g., $\mathcal{R}_{vac}(\beta)$ indicates that β is the bifurcation parameter that varies.

For a totally effective vaccine ($\sigma = 0$), a unique $I^* \in (0, 1]$ such that $H(I^*) = 0$ can be found explicitly for $\mathcal{R}_{vac} > 1$, and the bifurcation is forward with \mathcal{R}_{vac} behaving as a (local) threshold [13]. For a leaky vaccine, $\sigma \in (0, 1)$, the zeros of $H(I)$ for $I \in (0, 1]$ cannot be found analytically. We proceed to obtain numerical estimates by using the following algorithm.

- Choose a parameter $a \in \mathcal{A}$.
- Fix the value of all other elements of \mathcal{A} .
- Choose a_{min} , a_{max} and Δa for a .

```

for  $a_k = a_{min}$  to  $a_{max}$  do
  Compute  $I^*$  such that  $H(I^*, a_k) = 0$ , using MATLAB's fzero function.
  Compute  $\mathcal{R}_{vac}(a)$  for this value  $a_k$ .
   $a_k = a_k + \Delta a$ .
end for
    
```

Results of the use of this procedure give zero, one or two values of I^* . Thus two bifurcation scenarios are possible, as summarized in Figure 13.3. Example bifurcation diagrams are plotted in Figures 13.4(a) and 13.5.

In order to be able to characterize the nature of the bifurcation, we then need to define \mathcal{R}_c as in Section 4.1. To obtain a numerical estimate of \mathcal{R}_c , we use the same procedure as for the visualization of the bifurcation: we find the value I^* such that $H(I^*, a) = 0$ and $dH(I^*, a)/dI = 0$, for a given parameter $a \in \mathcal{A}$ with all other elements of \mathcal{A} fixed.

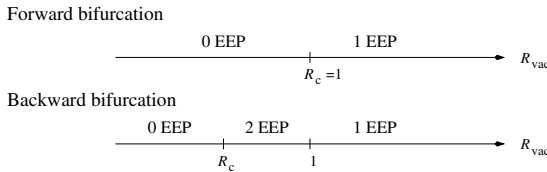

Figure 13.3. Possible bifurcation scenarios.

Suppose that $\mathcal{R}_0 > 1$ (otherwise there is no EEP, as was remarked in Section 3). When $\mathcal{R}_{vac} < \mathcal{R}_c$, there is no EEP as $H(0) < 0$ and numerical simulations indicate that $H < 0$ on $(0, 1)$; when $\mathcal{R}_{vac} > 1$, $H(0) > 0$ so there is an odd number of EEP (numerical simulations indicate this number is 1). When $\mathcal{R}_c = 1$, we are then in the case of a forward bifurcation, as illustrated in the first part of Figure 13.3 and in Figure 13.4(c). The backward bifurcation arises when $\mathcal{R}_c < 1$. In this case, when $\mathcal{R}_c < \mathcal{R}_{vac} < 1$, $H(0) < 0$ so there is an even number of zeros of H in $(0, 1]$. Numerical simulations indicate that the number of EEP is 2. The system then undergoes the transitions shown in the second part of Figure 13.3.

5.2 Numerical bifurcation analysis and integration

We use the following parameter values. We suppose a 3 weeks disease duration ($\gamma = 1/21$), taking the time unit as one day. The average lifetime is assumed to be 75 years ($d = 1/(75 \times 365)$), and the average

number of adequate contacts per day is estimated as $\beta = 0.4$. The vaccine is assumed to be 10% leaky ($\sigma = 0.1$), and susceptibles are vaccinated at the rate $\phi = 0.1$. Finally, we assume that the vaccine stops being effective after 5 years, *i.e.*, $\omega = 1825$.

These parameters give $\mathcal{R}_0 = 8.3936$ and $\mathcal{R}_{vac}(\beta) = 0.8819$ from (4.5), which is in the range of the backward bifurcation since (using the above method) $\mathcal{R}_c(\beta)$ is estimated as 0.78. The bifurcation diagram is depicted in Figure 13.4(a). Note that in the vicinity of \mathcal{R}_c , it is very difficult for MATLAB's `fzero` function to find solutions (since it detects sign changes and $\mathcal{R}_{vac} = \mathcal{R}_c$ corresponds to tangency); hence the non-closed curve. Numerical simulations of the DDE model indicate that there are no additional bifurcations; solutions either go to the DFE or to the (larger) EEP, as depicted in Figure 13.4(b), which shows some solutions for $I(t)$ with the above parameter values. These same parameter values, except that $\sigma = 0.3$, give $\mathcal{R}_{vac}(\beta) = 2.55$, and there is a forward bifurcation (see Figure 13.4(c)) with solutions going to the endemic equilibrium as depicted in Figure 13.4(d).

To obtain Figures 13.4(b), 13.4(d), system (4.3) is integrated numerically. These numerical simulations are run using `dde23` [205], an example code (as well as an example code with `XPPAUT`) being given in Appendix 1. Initial data is $I(t) = c$, for $t \in [-\omega, 0]$, with c varying from 0 to 1 by steps of 0.02.

Figure 13.5 shows the bifurcation for these parameter values as a function of ω . The situation is clearly different from that of Figure 13.4(a), since in Figure 13.5 every value of ω gives at least one endemic equilibrium. Let ω_m be the value of ω determined by solving $\mathcal{R}_{vac}(\omega) = 1$ with \mathcal{R}_{vac} given by (4.5). If all other parameters are fixed as given at the beginning of this section, and for small waning time, $0 < \omega < \omega_m = 457.032$, giving $\mathcal{R}_{vac}(\omega) > 1$, the only stable equilibrium is a large endemic one. This is of course a highly undesirable state in terms of epidemic control. Then increasing ω (*i.e.*, increasing the waning time) past ω_m allows the DFE to become locally stable, and it is found numerically that solutions starting with $I(0)$ below the unstable endemic equilibrium tend to the DFE. Increasing ω beyond 1000 days seems ineffective in terms of disease control, since there is no increase in the initial value of infectives that tend to the DFE (see Figure 13.5).

6. A few words of warning

Even more so than with ordinary differential equations, great care has to be taken when running numerical integrations of delay differential equations. In [47], Cooke, van den Driessche and Zou study the dynamics

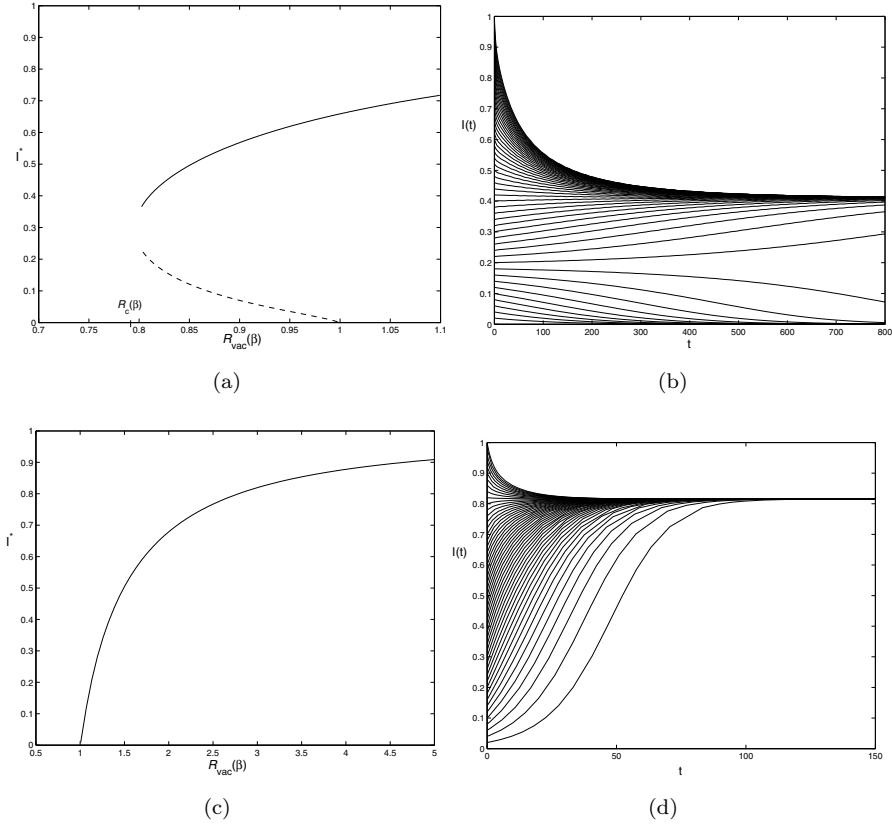

Figure 13.4. Bifurcation diagram and some solutions of (4.3). (a) and (b): Backward bifurcation case, parameters as in the text. (c) and (d): Forward bifurcation case, parameters as in the text except that $\sigma = 0.3$.

of the following equation for an adult population $N(t)$ with maturation delay:

$$N'(t) = be^{-aN(t-T)}N(t-T)e^{-d_1T} - dN(t) \tag{6.1}$$

Here $d > 0$ is the death rate constant, $b > d$ and $a > 0$ are parameters in the birth function, T is a developmental or maturation time and d_1 is the death rate constant for each life stage prior to the adult stage. In particular, they prove [47, Corollary 3.4] that Hopf bifurcation may occur for (6.1) even for $d_1 = 0$. For fixed values of the parameters, as T increases the equilibrium may switch from being stable to unstable, giving rise to periodic solutions. For $d_1 > 0$, it is possible for stability of the equilibrium to be regained as T increases further. They then proceed to illustrate the stability switches by numerical simulations of

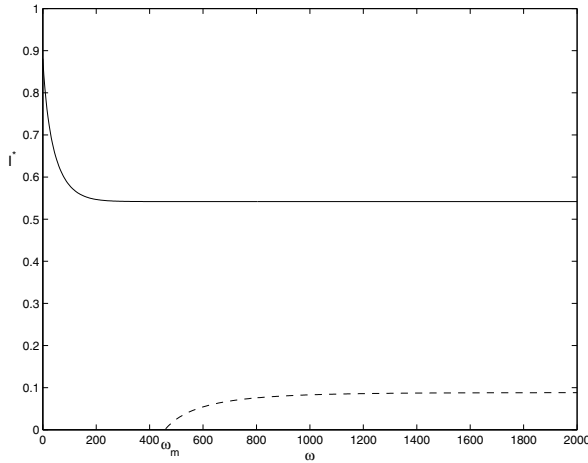

Figure 13.5. Value of I^* as a function of ω by solving $H(I, \omega) = 0$, parameters as in text.

(6.1) using XPPAUT. For $d_1 > 0$, equation (6.1) has a delay dependent parameter. The introduction of delay dependent parameters can lead to dramatic differences in dynamics, see [27].

Using the demography of (6.1), the authors of [47] formulate the following SIS model with maturation delay [47, (4.2)]

$$\begin{aligned} I'(t) &= \beta(N(t) - I(t))\frac{I(t)}{N(t)} - (d + \epsilon + \gamma)I(t) \\ N'(t) &= be^{-a(t-T)}N(t-T)e^{-d_1T} - dN(t) - \epsilon I(t) \end{aligned} \quad (6.2)$$

where $S(t) = N(t) - I(t)$, $\epsilon \geq 0$ is the disease induced death rate constant, $\gamma \geq 0$ is the recovery rate constant, and standard incidence $\beta SI/N$ is assumed. They perform numerical simulations of (6.2), and, in particular, obtain periodic solutions for parameter values $a = d = d_1 = 1$, $b = 80$, $\gamma = 0.5$, $T = 0.2$, $\epsilon = 10$ and $\beta = 20$.

But... When documenting their delay differential equation numerical integrator `dde23` [205], Shampine and Thompson tested their algorithm on a large number of delay systems, among which were equation (6.1) and system (6.2). With parameters as in the paragraph above, they obtain a figure similar to Figure 13.6, which shows damped oscillations to an endemic steady state.

So, what is wrong? For delay differential equations, XPP (the numerical integrator part of XPPAUT) uses a fixed step-size numerical integrator, whereas `dde23` uses a variable step-size. With the particular values of the parameters chosen for $\beta = 20$, the fixed step-size is too

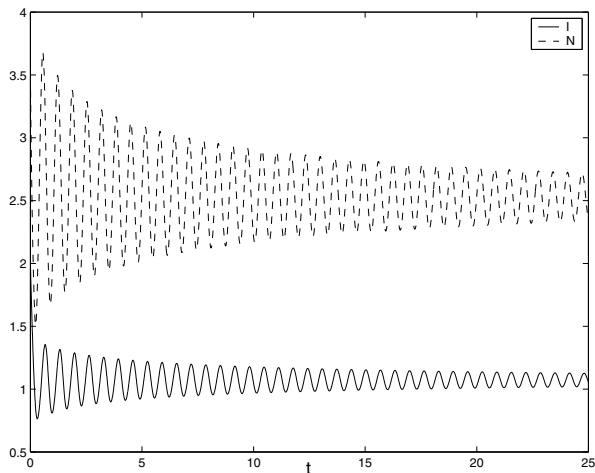

Figure 13.6. Plot of the solution of (6.2), with parameters as in the text, using `dde23`.

large (its default value is 0.05). In a case in which variables I and N undergo a very quick initial drop, this is overlooked by the first integration step of XPP, and the solver ends caught in the solution curve of a nearby periodic solution. Setting the step size in XPP to 0.005, as in the Erratum of [47], is sufficient to obtain a correct solution as shown in Figure 13.6.

Acknowledgements

This research was supported in part by MITACS and NSERC. The authors acknowledge helpful discussions on probabilistic aspects of disease transmission with J. Hsieh, and thank K.L. Cooke and J. Velasco-Hernández for collaboration on the vaccination model.

Appendix

1. Program listings

The following gives examples of code used with MATLAB and XPPAUT to run numerical integrations of system (4.3). In both cases, constant initial data has been used, though both do allow for initial data of functional or of numerical type. In the case of constant initial data, both programs have the same behavior: they extend the given initial point to the interval $[-\omega, 0]$. Note that we make use of the third “fake” state variable $X(t)$ introduced in (4.4), and of its time derivative, in order to take care of the integral term in (4.3b).

1.1 MatLab code

The following is called `vaccddeRHS.m`. It defines the vector field of (4.3). This is done in a very similar manner to the definition of the vector field that would be used in a `MatLab` program with an ordinary differential equation solver. The one important difference is in the variable `Z`. `dde23` can handle many discrete delays. The variable `Z`, which is passed as an argument to the function, contains the state of the system at the different delays. Here, we have only one delay. But suppose we had two delays ω_1 and ω_2 . Then each column of `Z` would contain the state variables corresponding to one of the delays:

$$Z = \begin{bmatrix} I_{\omega_1} & I_{\omega_2} \\ V_{\omega_1} & V_{\omega_2} \end{bmatrix}$$

```
function v = vaccddeRHS(t,y,Z,params)
beta=params(1);
d=params(2);
g=params(3); %MatLab hates gamma's other than gamma functions.
phi=params(4);
omega=params(5);
sigma=params(6);
ylag = Z(:,1);
v = zeros(3,1);
v(1) = beta*(1-y(1)-(1-sigma)*y(2))*y(1)-(d+g)*y(1);
v(2) = phi*(1-y(1)-y(2))...
      -phi*(1-ylag(1)-ylag(2))*exp(-d*omega)*exp(-sigma*beta*y(3))...
      -sigma*beta*y(1)*y(2)-d*y(2);
v(3) = y(1) - ylag(1);
```

This function is then used by the main calling routine, which follows. This particular procedure will run a certain number of integrations of system (4.3). The initial condition for $V(0)$ (lines 16 and 17) is obtained from (4.2) by setting $t = 0$, that of $X(0)$ follows from (4.4).

```
path(path, '/home/jarino/programs/matlab/dde23/ddeall')
beta=0.4;
d=3.65297E-05;
g=0.047619048;
phi=0.1;
omega=1825;
sigma=0.1;

ylim([0,1]);
hold on;
for I0=0:0.02:1, %Loop on initial conditions
    % The delay must be added to the parameter vector since it
    % is used in the vector field.
    params=[beta, d, g, phi, omega, sigma];
    % Initial conditions: I0 is given, V0 and X0 are computed.
    V0=(phi*(1-I0)*(1-exp(-omega*(d+beta*sigma*I0)))+...
        /(d+beta*sigma*I0+phi*(1-exp(-omega*(d+beta*sigma*I0)))));
    X0=I0*omega; % Initial condition on X is easy to compute.
    IC=[I0,V0,X0]; % Extended to [-omega,0] if only given at 0.
    tspan=[0,800]; % Set integration time range.
    % Call the numerical routine.
    sol = dde23('vaccddeRHS',omega,IC,tspan,[],params);
    plot(sol.t,sol.y(1,:)); %Plot I(t) versus t
```

```
end;
xlabel('t'); ylabel('I', 'Rotation', 0);
```

1.2 XPPAUT code

The following code allows the integration of system (4.3) with XPPAUT. Note that the initial conditions for V and X have to be computed explicitly from equations (4.2) and (4.4), since XPP does not allow inclusion of unevaluated formula in the code.

```
# Constants
p beta=0.4, d=3.65E-05, g=0.04762, phi=0.1, omega=1825, sigma=0.1;
# The system
dI/dt = beta*(1-I-V+sigma*V)*I - (d+g)*I
dV/dt = phi*(1-I-V)-phi*(1-delay(I,omega)-delay(V,omega))\
        *exp(-d*omega)*exp(-sigma*beta*X)-(sigma*beta*I*V)-d*V
dX/dt = I-delay(I,omega)
# Initial conditions
I(0)=0.1
V(0)=0.8650595334
X(0)=182.5
# set maxdelay
@ delay=2000
@ ylow=0
@ bell=0
@ bound=500
@ XP=I, YP=V
@ XHI=1, YHI=1
# done
d
```

2. Delay differential equations packages

Several packages and even software are available for the numerical integration and/or the study of bifurcations in delay differential equations. Here is a short list, elaborated from the list given by Koen Engelborghs¹.

2.1 Numerical integration

The following are numerical solvers for DDE's.

Archi (C.A.H. Paul) (Fortran 77) simulates a large class of functional differential equations. In particular, Archi can be used to estimate unknown scalar parameters in delay and neutral differential equations.

dde23 (L. Shampine, S. Thompson) (MATLAB) is a MATLAB package that integrates delay differential equations. It is integrated in the latest versions of MATLAB (starting with Release 13).

DDVERK (H. Hiroshi, W. Enright) (Fortran 77) simulates retarded and neutral differential equations with several fixed discrete delays.

DifEqu (G. Makay) (DOS, Windows) simulates differential equations with discrete possibly varying delays.

¹<http://www.cs.kuleuven.ac.be/~koen/delay>

DKLAG6 (S. Thompson) (Fortran 77, Fortran 90, C) simulates retarded differential equations with several fixed discrete delays.

Dynamics Solver (J. M. Aguirregabiria) simulates differential equations with discrete possibly varying delays.

RETARD (E. Hairer, G. Wanner) simulates retarded differential equations with several fixed discrete delays.

RADAR5 (N. Guglielmi, E. Hairer) (Fortran 90) simulates retarded differential-algebraic equations, including neutral problems with vanishing or small delays.

XPPAUT (G.B. Ermentrout) (Unix, Windows) simulates differential equations with several fixed discrete delays. XPPAUT is a standalone software.

2.2 Bifurcation analysis

The following software packages provide some means to carry out numerical bifurcation analysis of delay differential equations.

BIFDD (B.D. Hassard) (Fortran 77) normal form analysis of Hopf bifurcations of differential equations with several fixed discrete delays.

DDE-BIFTOOL (K. Engelborghs) (MATLAB) allows computation and stability analysis of steady state solutions, their fold and Hopf bifurcations and periodic solutions of differential equations with several fixed discrete delays.

XPPAUT (G.B. Ermentrout) (Unix, Windows) allows limited stability analysis of steady state solutions of differential equations with several fixed discrete delays.

References

- [1] M. Adimy and K. Ezzinbi, Spectral decomposition for some functional differential equations, Submitted.
- [2] E. Ait Dads, *Contribution à l'existence de solutions pseudo presque périodiques d'une classe d'équations fonctionnelles*, Doctorat d'Etat Université Cadi Ayyad, Marrakech (1994).
- [3] E. Ait Dads, K. Ezzinbi, O. Arino, Pseudo almost periodic solutions for some differential equations in a Banach space, *Nonlinear Analysis, Theory, Methods & Applications* **28** (1997), 1141–1155.
- [4] E. Ait Dads and K. Ezzinbi, Boundedness and almost periodicity for some state-dependent delay differential equations, *Electron. J. Differential Equations* **2002** (2002), No. 67, 1–13.
- [5] W.C. Allee, *Animal Aggregations: A Study in General Sociology*, Chicago University Press, Chicago (1931).
- [6] H. Amann, *Linear and Quasilinear Parabolic Problems*, Birkhäuser (1995).
- [7] L. Amerio, and G. Prouse, *Almost Periodic Functions and Functional Analysis*, Van Nostrand (1971).
- [8] B. Amir and L. Maniar, *Composition of pseudo almost periodic functions and semilinear Cauchy problems with non dense domain*, *Ann. Math. Pascal* **6** (1999), 1–11.
- [9] B. Amir and L. Maniar, Asymptotic behavior of hyperbolic Cauchy problems for Hille-Yosida operators with an application to retarded differential equations, *Questiones Mathematicae* **23** (2000), 343–357.
- [10] B. Amir and L. Maniar, Existence and asymptotic behavior of solutions of semilinear Cauchy problems with non dense domain via extrapolation spaces, *Rend. Circ. Mat. Palermo* **XLIX** (2000), 481–496.

- [11] Y. Ammar, *Eine dreidimensionale invariante Mannigfaltigkeit für autonome Differentialgleichungen mit Verzögerung*, Doctoral dissertation, München (1993).
- [12] R.M. Anderson and R.M. May, *Infectious Diseases of Humans*, Oxford University Press (1991).
- [13] J. Arino, K.L. Cooke, P. van den Driessche, and J. Velasco-Hernández, An epidemiology model that includes vaccine efficacy and waning, *Discr. Contin. Dyn. Systems B* **4** (2003), 479–495.
- [14] O. Arino and M. Kimmel, Stability analysis of models of cell production systems, *Math. Modelling* **7** (1986), 1269–1300.
- [15] O. Arino, E. Sánchez and A. Fathallah, State-dependent delay differential equations in population dynamics: modeling and analysis, in “*Topics in Functional Differential and Difference Equations*”, ed. T. Faria and P. Freitas, *Fields Institute Commun.* **29** (2001), Amer. Math. Soc., Providence, pp. 19–36.
- [16] O. Arino and E. Sanchez, *A saddle point theorem for functional state-dependent delay equations*, preprint (2002).
- [17] A. Bátkai, L. Maniar and A. Rhandi, Regularity properties of perturbed Hille-Yosida operators and retarded differential equations, *Semigroup Forum* **64** (2002), 55–70.
- [18] M. Bardi, An equation of growth of a single species with realistic dependence on crowding and seasonal factors, *J. Math. Biol.* **17** (1983), 33–43.
- [19] M. Bardi and A. Schiaffino, Asymptotic behavior of positive solutions of periodic delay logistic equations, *J. Math. Biol.* **14** (1982), 95–100.
- [20] M. Bartha, Convergence of solutions for an equation with state-dependent delay, *J. Math. Anal. Appl.* **254** (2001), 410–432.
- [21] M. Bartha, Periodic solutions for differential equations with state-dependent delay and positive feedback, *Nonlinear Analysis - TMA* **53** (2003), 839–857.
- [22] C.J.K. Batty, and R. Chill, Bounded convolutions and solutions of inhomogeneous Cauchy problems, *Forum Math.* **11** (1999), 253–277.
- [23] J.R. Beddington and R.M. May, Time delays are not necessarily destabilizing, *Math. Biosci.* **27** (1975), 109–117.
- [24] J. Bélair, Population models with state-dependent delays, in *Mathematical Population Dynamics*, ed. O. Arino, D. E. Axelrod and M. Kimmel, Marcel Dekker, New York (1991), pp. 165–176.

- [25] J. Bélair and S. A. Campbell, Stability and bifurcations of equilibrium in a multiple-delayed differential equation, *SIAM J. Appl. Math.* **54** (1994), 1402–1424.
- [26] J. Bélair, M.C. Mackey and J.M. Mahaffy, Age-structured and two delay models for erythropoiesis, *Math. Biosci.* **128** (1995), 317–346.
- [27] E. Beretta and Y. Kuang, Geometric stability switch criteria in delay differential systems with delay dependent parameters, *SIAM J. Math. Anal.* **33** (2002), 1144–1165.
- [28] A. Beuter, J. Bélair and C. Labrie, Feedback and delay in neurological diseases: a modeling study using dynamical systems, *Bull. Math. Biol.* **55** (1993), 525–541.
- [29] R.H. Bing, *The Geometric Topology of 3-Manifolds*, A.M.S. Colloquium Publ., Vol. 40, Providence (1983).
- [30] S.P. Blythe, R.M. Nisbet and W.S.C. Gurney, Instability and complex dynamic behaviour in population models with long time delays, *Theor. Pop. Biol.* **22** (1982), 147–176.
- [31] L.L. Bonilla and A. Liñán, Relaxation oscillations, pulses, and traveling waves in the diffusive Volterra delay-differential equation, *SIAM J. Appl. Math.* **44** (1984), 369–391.
- [32] R.D. Braddock and P. van den Driessche, On a two lag differential delay equation, *J. Austral. Math. Soc. Ser. B* **24** (1983), 292–317.
- [33] F. Brauer. Time lag in disease models with recruitment. *Mathematics and Computer Modeling* **31** (2000), 11–15.
- [34] F. Brauer and C. Castillo-Chávez, *Mathematical Models in Population Biology and Epidemiology*, Springer (2001).
- [35] N.F. Britton, *Reaction-Diffusion Equations and their Applications to Biology*, Academic Press, London (1986).
- [36] N.F. Britton, Spatial structures and periodic traveling waves in an integro-differential reaction-diffusion population model, *SIAM J. Appl. Math.* **50** (1990), 1663–1688.
- [37] S. Busenberg and K.L. Cooke, Periodic solutions of a periodic nonlinear delay differential equation, *SIAM J. Appl. Math.* **35** (1978), 704–721.
- [38] S. Busenberg and K.L. Cooke. *Vertically Transmitted Diseases*. Springer-Verlag (1993).
- [39] S. Busenberg and W. Huang, Stability and Hopf bifurcation for a population delay model with diffusion effects, *J. Differential Equations* **124** (1996), 80–107.

- [40] Y. Cao and T.C. Gard, Ultimate bounds and global asymptotic stability for differential delay equations, *Rocky Mountain J. Math.* **25** (1995), 119-131.
- [41] M.-P. Chen, J.S. Yu, X.Z. Qian and Z.C. Wang, On the stability of a delay differential population model, *Nonlinear Analysis - TMA*, **25** (1995), 187-195.
- [42] Y. Chen, Global attractivity of a population model with state-dependent delay, in “*Dynamical Systems and Their Applications in Biology*”, ed. S. Ruan, G. Wolkowicz and J. Wu, *Fields Institute Communications* **36** (2003), Amer. Math. Soc., Providence, pp. 113-118.
- [43] S.N. Chow and H.O. Walther, *Characteristic multipliers and stability of symmetric periodic solutions of $\dot{x}(t) = g(x(t-1))$* . *Transactions of the A.M.S.* **307** (1988), 127-142.
- [44] Ph. Clément, O. Diekmann, M. Gyllenberg, H.J.A.M. Heijmans and H.R. Thieme, Perturbation theory for dual semigroups. I. The sun-reflexive case, *Math. Ann.* **277** (1987), 709-725.
- [45] D.S. Cohen and S. Rosenblat, A delay logistic equation with growth rate, *SIAM J. Appl. Math.* **42** (1982), 608-624.
- [46] K.L. Cooke, Stability analysis for a vector disease model, *Rocky Mountain J. Math.* **9** (1979), 31-42.
- [47] K.L. Cooke, P. van den Driessche, and X. Zou. Interaction of maturation delay and nonlinear birth in population and epidemic models. *J. Math. Biol.* **39** (1999) 332-352. Erratum: *J. Math. Biol.*, **45** (2002), 470.
- [48] K.L. Cooke and W. Huang, *On the problem of linearization for state-dependent delay differential equations*. Proceedings of the A.M.S. 124 (1996), 1417-1426.
- [49] K.L. Cooke and J.A. Yorke, Some equations modelling growth processes and gonorrhoea epidemics, *Math. Biosci.* **16** (1973), 75-101.
- [50] C. Corduneanu, *Almost-Periodic Functions*, 2nd edition, Chelsea , New York (1989).
- [51] C. Corduneanu, *Integral Equations and Stability of Feedback Systems*, Academic Press New York and London (1973).
- [52] J.M. Cushing (1977a), *Integrodifferential Equations and Delay Models in Population Dynamics*, Lecture Notes in Biomathematics **20** (1977), Springer-Verlag, Heidelberg.

- [53] J.M. Cushing (1977b), Time delays in single growth models, *J. Math. Biol.* **4** (1977), 257-264.
- [54] F.A. Davidson and S.A. Gourley, The effects of temporal delays in a model for a food-limited diffusion population, *J. Math. Anal. Appl.* **261** (2001), 633-648
- [55] W. Desch, G. Gühring and I. Györi, Stability of nonautonomous delay equations with a positive fundamental solution, *Tübingerberichte zur Funktionalanalysis* **9** (2000).
- [56] O. Diekmann, S.A. van Gils, S.M. Verduyn Lunel and H.O. Walter, *Delay Equations Functional, complex and nonlinear Analysis*, Springer Verlag (1991).
- [57] O. Diekmann, S.A. van Gils, S.M. Verduyn Lunel and H.O. Walther, *Delay Equations: Functional-, Complex- and Nonlinear Analysis*. Springer, New York (1995).
- [58] O. Diekmann and J.A.P. Heesterbeek, *Mathematical Epidemiology of Infectious Diseases: Model Building, Analysis and Interpretation*, Wiley (2000).
- [59] P. Dormayer, An attractivity region for characteristic multipliers of special symmetric periodic solutions of $\dot{x}(t) = \alpha f(x(t-1))$ near critical amplitudes, *J. Math. Anal. Appl.* **169** (1992), 70-91.
- [60] P. Dormayer, *Floquet multipliers and secondary bifurcation of periodic solutions of functional differential equations*, Habilitation thesis, Gießen, 1996.
- [61] R.D. Driver, Existence theory for a delay-differential system, *Contributions to Differential Equations* **1** (1963), 317-336.
- [62] Eichmann, M., *A local Hopf bifurcation theorem for differential equations with state-dependent delays*, Doctoral dissertation, Justus-Liebig-Universität, Gießen (2006).
- [63] K.J. Engel and R. Nagel, *One-Parameter Semigroups for Linear Evolution Equations*, Graduate Texts in Mathematics **194** Springer-Verlag (2000).
- [64] K. Ezzinbi, *Contribution à l'étude des équations différentielles à retard en dimension finie et infinie : existence et aspects qualitatifs, application à des problèmes de dynamique de populations*, Thesis, Marrakesh (1997).
- [65] M. D. Fargue, Reducibilité des systèmes héréditaires à des systèmes dynamiques, *C. R. Acad. Sci. Paris. Sér. B* **277** (1973), 471-473.

- [66] T. Faria and Huang, Stability of periodic solutions arising from Hopf bifurcation for a reaction-diffusion equation with time delay, in “*Differential Equations ad Dynamical Systems*”, ed. A. Galves, J. K. Hale and C. Rocha, *Fields Institute Communications* **31** (2002), Amer. Math. Soc., Providence, pp. 125-141.
- [67] W. Feng and X. Lu, Asymptotic periodicity in diffusive logistic equations with discrete delays, *Nonlinear Analysis - TMA* **26** (1996), 171-178.
- [68] W. Feng and X. Lu, Global periodicity in a class of reaction-diffusion systems with time delays, *Discrete Contin. Dynam. Systems - Ser. B* **3** (2003), 69-78.
- [69] Z. Feng and H.R. Thieme, Endemic models with arbitrarily distributed periods of infection I: Fundamental properties of the model, *SIAM J. Appl. Math.* **61** (2000), 803-833.
- [70] P. Fife, *Mathematical Aspects of Reacting and Diffusing Systems*, Lecture Notes in Biomathematics **28**, Springer-Verlag, Berlin (1979).
- [71] R.A. Fisher (1937), The wave of advance of advantageous genes, *Ann. Eugenics* **7**, 353-369.
- [72] A.C. Flower and M.C. Mackey, Relaxation oscillations in a class of delay differential equations, *SIAM J. Appl. Math.* **63** (2002), 299-323.
- [73] H.I. Freedman and K. Gopalsamy, Global stability in time-delayed single-species dynamics, *Bull. Math. Biol.* **48** (1986), 485-492.
- [74] H.I. Freedman and J. Wu, Periodic solutions of single-species models with periodic delay, *SIAM J. Math. Anal.* **23** (1992), 689-701.
- [75] H.I. Freedman and H. Xia, Periodic solutions of single species models with delay, in “*Differential Equations, Dynamical Systems, and Control Science*”, ed. K. D. Elworthy, W. N. Everitt and E. B. Lee, Marcel Dekker, New York, pp. 55-74 (1994).
- [76] H.I. Freedman and X. Zhao, Global asymptotics in some quasi-monotone reaction-diffusion systems with delays, *J. Differential Equations* **137** (1997), 340-362.
- [77] R.E. Gaines and J. L. Mawhin, *Coincidence Degree and Nonlinear Differential Equations*, Springer-Verlay, Berlin (1977).
- [78] K. Gopalsamy, Global stability in the delay-logistic equation with discrete delays, *Houston J. Math.* **16** (1990), 347-356.
- [79] K. Gopalsamy, *Stability and Oscillations in Delay Differential Equations of Population Dynamics*, Mathematics and its Applications **74**, Kluwer Academic Pub., Dordrecht (1992).

- [80] K. Gopalsamy and B.D. Aggarwala, The logistic equation with a diffusionally coupled delay, *Bull. Math. Biol.* **43** (1981), 125-140.
- [81] K. Gopalsamy, M.R.S. Kulenović and G. Ladas, Time lags in a “food-limited” population model, *Appl. Anal.* **31** (1988), 225-237.
- [82] K. Gopalsamy, M.R.S. Kulenović and G. Ladas (1990a), Environmental periodicity and time delays in a “food-limited” population model, *J. Math. Anal. Appl.* **147** (1990), 545-555.
- [83] K. Gopalsamy, M.R.S. Kulenović and G. Ladas (1990b), Oscillations and global attractivity in models of hematopoiesis, *J. Dynamics Differential Equations* **2** (1990), 117-132.
- [84] K. Gopalsamy and G. Ladas, On the oscillation and asymptotic behavior of $N(t) = N(t)[a + bN(t - \tau) - cN^2(t - \tau)]$, *Quart. Appl. Math.* **48** (1990), 433-440.
- [85] S.A. Gourley and N.F. Britton, On a modified Volterra population equation with diffusion, *Nonlinear Analysis - TMA* **21** (1993), 389-395.
- [86] S.A. Gourley and M.A.J. Chaplain, Travelling fronts in a food-limited population model with time delay, *Proc. Royal Soc. Edinburgh* **132A** (2002), 75-89.
- [87] S.A. Gourley and S. Ruan, Dynamics of the diffusive Nicholson’s blowflies equation with distributed delay, *Proc. Royal Soc. Edinburgh* **130A** (2000), 1275-1291.
- [88] S.A. Gourley and J.W.-H. So, Dynamics of a food-limited population model incorporating nonlocal delays on a finite domain, *J. Math. Biol.* **44** (2002), 49-78.
- [89] J.R. Greaf, C. Qian and P.W. Spikes, Oscillation and global attractivity in a periodic delay equation, *Canad. Math. Bull.* **38** (1996), 275-283.
- [90] D. Green and H.W. Stech, Diffusion and hereditary effects in a class of population models, in “*Differential Equations and Applications in Ecology, Epidemics, and Population Problems*,” ed. S. Busenberg and K. Cooke, Academic Press, New York, pp. 19-28 (1981).
- [91] E.A. Grove, G. Ladas and C. Qian, Global attractivity in a “food-limited” population model, *Dynamic. Systems Appl.* **2** (1993), 243-249.
- [92] G. Gühring and F. Rübiger, Asymptotic properties of mild solutions of evolution equations with applications to retarded differential equations, *Abstr. Appl. Anal.* **4** (1999), 169-194.

- [93] G. Gühring, F. Rábiger and W. Ruess, Linearized stability for semilinear non-autonomous equations with applications to retarded differential equations, to appear in *Diff. Integ. Equat.*
- [94] G. Gühring, F. Rábiger and R. Schnaubelt, A characteristic equation for non-autonomous partial functional differential equations, *J. Differential Equations*, to appear.
- [95] W.S.C. Gurney, S.P. Blythe and R.M. Nisbet, Nicholson's blowflies revisited, *Nature* **287** (1980), 17-21.
- [96] I. Györi and S. I. Trofimchuk, Global attractivity in $x'(t) = -\delta x(t) + pf(x(t-\tau))$, *Dynamic. Systems Appl.* **8** (1999), 197-210.
- [97] I. Györi and S. I. Trofimchuk, On existence of rapidly oscillatory solutions in the Nicholson blowflies equation, *Nonlinear Analysis - TMA* **48** (2002), 1033-1042.
- [98] K.P. Hadeler, On the stability of the stationary state of a population growth equation with time-lag, *J. Math. Biol.* **3** (1976), 197-201.
- [99] K.P. Hadeler and J. Tomiuk, Periodic solutions of difference-differential equations, *Arch. Rational Mech. Anal.* **65** (1977), 82-95.
- [100] J.K. Hale *Ordinary Differential Equations*, Wiley-Inter Science, A Division of John Wiley & Sons, New York, London, Sydney, Toronto (1969).
- [101] J.K. Hale, *Theory of Functional Differential Equations*, Springer Verlag (1977).
- [102] J. K. Hale and W. Huang, Global geometry of the stable regions for two delay differential equations, *J. Math. Anal. Appl.* **178** (1993), 344-362.
- [103] J.K. Hale and X.B. Lin, Symbolic dynamics and nonlinear semiflows. *Annali di Matematica Pura ed Applicata* **144** (1986), 229-259.
- [104] J.K. Hale and S. Verduyn Lunel, *Introduction to Functional Differential Equations*, Springer Verlag (1991).
- [105] J.K. Hale and S. Verduyn Lunel, *Introduction to Functional Differential Equations*. Springer, New York (1993).
- [106] T.G. Hallam and J.T. DeJuna, Effects of toxicants on populations: A qualitative approach III. Environmental and food chain pathways, *J. Theor. Biol.* **109** (1984), 411-429.

- [107] F. Hartung, T. Krisztin, H.O. Walther and J. Wu, *Functional differential equations with state-dependent delay: Theory and applications*, To appear in *Handbook of Differential Equations - Ordinary Differential Equations*, A. Canada, P. Drabek. and A. Fonda eds., Elsevier Science B. V., North Holland.
- [108] B.D. Hassard, N.D. Kazarinoff and Y.H. Wan (1981), *Theory and Applications of Hopf Bifurcation*, London Mathematical Society Lecture Note Series **41**, Cambridge University Press, Cambridge.
- [109] E. Hille and R.S. Phillips, *Functional Analysis and Semigroups*, Amer. Math. Soc. Providence (1975).
- [110] Y. Hino, S. Murakami and T. Naito, *Functional Differential Equations with Infinite Delay*, Lecture Notes in Mathematics 1473, Springer Verlag (1991).
- [111] W. Huang, Global dynamics for a reaction-diffusion equation with time delay, *J. Differential Equations* **143** (1998), 293-326.
- [112] H.W. Hethcote and P. van den Driessche. Two SIS epidemiologic models with delays. *J. Math. Biol.*, **40** (2000), 3–26.
- [113] G.E. Hutchinson, Circular cause systems in ecology, *Ann. N. Y. Acad. Sci.* **50** (1948), 221–246.
- [114] G.E. Hutchinson, *An Introduction to Population Ecology*, Yale University Press, New Haven (1978).
- [115] A.F. Ivanov, B. Lani-Wayda and H.O. Walther, *Unstable hyperbolic periodic solutions of differential delay equations*. In *Recent Trends in Differential Equations*, R.P. Agarwal ed., 301–316, WS-SIAA vol. 1, World Scientific, Singapore (1992).
- [116] A.F. Ivanov and J. Losson, *Stable rapidly oscillating solutions in delay differential equations with negative feedback*. *Differential and Integral Equations* **12** (1999), 811–832.
- [117] G.S. Jones (1962a), On the nonlinear differential-difference equation $f'(t) = -\alpha f(x-1)[1+f(x)]$, *J. Math. Anal. Appl.* **4** (1962), 440–469.
- [118] G.S. Jones (1962b), The existence of periodic solutions of $f'(t) = -\alpha f(x-1)[1+f(x)]$, *J. Math. Anal. Appl.* **5** (1962), 435–450.
- [119] S. Kakutani and L. Markus, On the non-linear difference-differential equation $y'(t) = [A - By(t-\tau)]y(t)$, in “*Contributions to the Theory of Nonlinear Oscillations*”, Vol. **4**, ed. S. Lefschetz, Princeton University Press, New Jersey, 1-18 (1958).
- [120] J.L. Kaplan and J.A. Yorke, *Ordinary differential equations which yield periodic solutions of differential delay equations*. *J. Math. Anal. Appl.* **48** (1974), 317-324.

- [121] J.L. Kaplan and J.A. Yorke, On the stability of a periodic solution of a differential delay equation, *SIAM J. Math. Anal.* **6** (1975), 268-282.
- [122] F. Kappel, Linear Autonomous Functional Differential Equations, Summer School on Delay Differential Equations Marrakesh June 7 – 16 (1995).
- [123] G. Karakostas, The effect of seasonal variations to the delay population equation, *Nonlinear Analysis -TMA* **6** (1982), 1143-1154.
- [124] G. Karakostas, Ch.G. Philos and Y.G. Sficas, Stable steady state of some population models, *J. Dynamics Differential Equations* **4** (1992), 161-190.
- [125] J. Kirk, J.S. Orr and J. Forrest, The role of chalone in the control of the bone marrow stem cell population, *Math. Biosci.* **6** (1970), 129-143.
- [126] R.L. Kitching, Time, resources and population dynamics in insects, *Austral. J. Ecol.* **2** (1977), 31-42.
- [127] A.N. Kolmogorov, I.G. Petrovskii and N.S. Piskunov, Étude de l'équation de le diffusion avec croissance de la quantité de mateère et son application à un problème biologique, *Moscow Univ. Bull.* **1** (1937), 1-25.
- [128] V.A. Kostitzin, Sur les équations intégrodifférentielles de la théorie de l'action toxique du milieu, *C. R. Acad. Sci.* **208** (1939), 1545-1547.
- [129] J. Kreulich, *Eberlein weak almost periodicity and differential equations in Banach spaces*, Ph.D. Thesis, Essen (1992).
- [130] C. Kribs-Zaleta and J. Velasco-Hernández. A simple vaccination model with multiple endemic states. *Math. Biosci.* **164** (2000), 183–201.
- [131] H.P. Krishnan, *An analysis of singularly perturbed delay-differential equations and equations with state-dependent delays*, Ph.D. thesis, Brown University, Providence (R.I.) (1998).
- [132] T. Krisztin, A local unstable manifold for differential equations with state-dependent delay, *Discrete and Continuous Dynamical Systems* **9** (2003), 993–1028.
- [133] T. Krisztin, Invariance and noninvariance of center manifolds of time- t maps with respect to the semiflow, *SIAM J. Math. Analysis* **36** (2004), 717–739.

- [134] T. Krisztin, C^1 -smoothness of center manifolds for differential equations with state-dependent delay, Preprint, to appear in *Nonlinear Dynamics and Evolution Equations*, Fields Institute Communications.
- [135] T. Krisztin and O. Arino, The 2-dimensional attractor of a differential equation with state-dependent delay, *J. Dynamics Differential Equations* **13** (2001), 453–522.
- [136] T. Krisztin and H.O. Walther, Unique periodic orbits for delayed positive feedback and the global attractor, *J. Dynamics and Differential Equations* **13** (2001), 1–57.
- [137] T. Krisztin, H.O. Walther and J. Wu, *Shape, Smoothness, and Invariant Stratification of an Attracting Set for Delayed Monotone Positive Feedback*. Fields Institute Monograph series vol. 11, A.M.S., Providence (1999).
- [138] T. Krisztin, H.O. Walther and J. Wu, The structure of an attracting set defined by delayed and monotone positive feedback, *CWI Quarterly* **12** (1999), 315–327.
- [139] T. Krisztin and J. Wu, Monotone semiflows generated by neutral equations with different delays in neutral and retarded parts, *Acta Mathematicae Universitatis Comenianae* **63** (1994), 207–220.
- [140] Y. Kuang, Global attractivity in delay differential equations related to models of physiology and population biology, *Japan. J. Indust. Appl. Math.* **9** (1992), 205–238.
- [141] Y. Kuang, *Delay Differential Equations with Applications in Population Dynamics*, Academic Press, New York (1993).
- [142] Y. Kuang and H.L. Smith (1992a), Slowly oscillating periodic solutions of autonomous state-dependent delay equations, *Nonlinear Analysis - TMA* **19** (1992), 855–872.
- [143] Y. Kuang and H.L. Smith (1992b), Periodic solutions of differential delay equations with threshold-type delays, *Contemporary Mathematics* **129** (1992), 153–175.
- [144] M.R.S. Kulenović, G. Ladas and Y.G. Sficas, Global attractivity in Nicholson's blowflies, *Appl. Anal.* **43** (1992), 109–124.
- [145] G. Ladas and C. Qian, Oscillation and global stability in a delay logistic equation, *Dynamics and Stability of Systems* **9** (1994), 153–162.
- [146] V. Lakshmikantham and S. Leela, *Differential and integral inequalities, theory and applications*, Volume 1, Academic Press, (1969).

- [147] B.S. Lalli and B.G. Zhang, On a periodic delay population model, *Quart. Appl. Math.* **52** (1994), 35-42.
- [148] K.A. Landman, Bifurcation and stability theory of periodic solutions for integrodifferential equations, *Stud. Appl. Math.* **62** (1980), 217-248.
- [149] B. Lani-Wayda, *Hyperbolic Sets, Shadowing and Persistence for Noninvertible Mappings in Banach Spaces*, Pitman Research Notes in Math., Vol. 334, Longman, Essex (1995).
- [150] B. Lani-Wayda, Erratic solutions of simple delay equations, *Transactions of the A.M.S.* **351** (1999), 901-945.
- [151] B. Lani-Wayda, *Wandering solutions of equations with sine-like feedback*. *Memoirs of the A.M.S.* Vol. 151, No. 718, 2001.
- [152] B. Lani-Wayda and R. Srzednicki, *The Lefschetz fixed point theorem and symbolic dynamics in delay equations*, *Ergodic Theory and Dynamical Systems* **22** (2002), 1215-1232.
- [153] B. Lani-Wayda and H.O. Walther, *Chaotic motion generated by delayed negative feedback. Part I: A transversality criterion*, *Differential and Integral Equations* **8** (1995), 1407-1452.
- [154] B. Lani-Wayda and H.O. Walther, *Chaotic motion generated by delayed negative feedback. Part II: Construction of nonlinearities*, *Mathematische Nachrichten* **180** (1996), 141-211.
- [155] Y. Latushkin, T. Randolph and R. Schnaubelt, Exponential dichotomy and mild solutions of nonautonomous equations in Banach spaces, preprint.
- [156] Y. Latushkin and R. Schnaubelt, The spectral mapping theorem for evolution semigroups on L^p associated with strongly continuous cocycles, preprint.
- [157] S.M. Lenhart and C.C. Travis, Global stability of a biological model with time delay, *Proc. Amer. Math. Soc.* **96** (1986), 75-78.
- [158] X. Li, S. Ruan and J. Wei, Stability and bifurcation in delay-differential equations with two delays, *J. Math. Anal. Appl.* **236** (1999), 254-280.
- [159] Y. Li, Existence and global attractivity of a positive periodic solution of a class of delay differential equation, *Sci. China Ser. A* **41** (1998), 273-284.
- [160] Y. Li and Y. Kuang, Periodic solutions in periodic state-dependent delay equations and population models, *Proc. Amer. Math. Soc.* **130** (2001), 1345-1353.

- [161] J. Lin and P.B. Kahn, Phase and amplitude instability in delay-diffusion population models, *J. Math. Biol.* **13** (1982), 383–393.
- [162] E. Liz, C. Martínez and S. Trofimchuk, Attractivity properties of infinite delay Mackey-Glass type equations, *Differential Integral Equations* **15** (2002), 875–896.
- [163] E. Liz, M. Pinto, G. Robledo, S. Trofimchuk and V. Tkachenko, Wright type delay differential equations with negative Schwarzian, *Discrete Contin. Dynam. Systems* **9** (2003), 309–321.
- [164] M. Louihi, M.L. Hbid and O. Arino, Semigroup properties and the Crandall-Liggett approximation for a class of differential equations with state-dependent delays, *J. Differential Equations* **181** (2002), 1–30.
- [165] S. Luckhaus, Global boundedness for a delay differential equation, *Trans. Amer. Math. Soc.* **294** (1986), 767–774.
- [166] N. MacDonald, *Time Lags in Biological Models*, Lecture Notes in Biomathematics **27** (1978), Springer-Verlag, Heidelberg.
- [167] M.C. Mackey and L. Glass, Oscillation and chaos in physiological control systems, *Science* **197** (1977), 287–289.
- [168] M.C. Mackey and J.G. Milton, Dynamics disease, *Ann. N. Y. Acad. Sci.* **504** (1988), 16–32.
- [169] M.C. Mackey and J.G. Milton, Feedback delays and the origins of blood cell dynamics, *Comm. Theor. Biol.* **1** (1990), 299–327.
- [170] J.M. Mahaffy, P.J. Zak and K.M. Joiner, A geometric analysis of the stability regions for a linear differential equation with two delays, *Internat. J. Bifur. Chaos* **5** (1995), 779–796.
- [171] J. Mallet-Paret, Morse decompositions for differential delay equations, *J. Differential Equations* **72** (1988), 270–315.
- [172] J. Mallet-Paret and R. Nussbaum, Boundary layer phenomena for differential-delay equations with state-dependent time lags, I, *Arch. Rational Mech. Anal.* **120** (1992), 99–146.
- [173] J. Mallet-Paret and R. Nussbaum, Boundary layer phenomena for differential-delay equations with state-dependent time lags, II, *J. reine angew. Math.* **477** (1996), 129–197.
- [174] J. Mallet-Paret and R. Nussbaum, Boundary layer phenomena for differential-delay equations with state-dependent time lags, III, *J. Differential Equations* **189** (2003), 640–692.
- [175] J. Mallet-Paret, R. Nussbaum and P. Paraskevopoulos, Periodic solutions for functional differential equations with multiple state-dependent time lags, *Topol. Methods Nonlinear Anal.* **3** (1994), 101–162.

- [176] J. Mallet-Paret and G. Sell, Systems of differential delay equations: Floquet multipliers and discrete Lyapunov functions, *J. Differential Equations* **125** (1996), 385–440.
- [177] J. Mallet-Paret and H.O. Walther, *Rapidly oscillating solutions are rare in scalar systems governed by monotone negative feedback with a time lag*. Preprint, 1994.
- [178] L. Maniar and A. Rhandi, Extrapolation and inhomogeneous retarded differential equations in infinite dimensional Banach space via extrapolation spaces, *Rend. Circ. Mat. Palermo* **47** (1998), 331-346.
- [179] J. E. Marsden and M. McCracken, *The Hopf Bifurcation and Its Applications*, Applied Mathematical Sciences **19**, Springer-Verlag, New York (1976).
- [180] R.M. May, *Stability and Complexity in Model Ecosystems*, 2nd ed., Princeton University Press, Princeton (1974).
- [181] H. McCallum, N. Barlow, and J. Hone, How should pathogen transmission be modelled? *Trends Ecol. Evol.*, **16** (2001), 295–300.
- [182] R.K. Miller, On Volterra's population equation, *SIAM J. Appl. Math.* **14** (1966), 446-452.
- [183] R.K. Miller, *Nonlinear Volterra Integral Equations*, Benjamin Press, Menlo Park, California (1971).
- [184] Y. Morita, Destabilization of periodic solutions arising in delay-diffusion systems in several space dimensions, *Japan J. Appl. Math.* **1** (1984), 39-65.
- [185] J.D. Murray, *Mathematical Biology*, Biomathematics **19**, Springer-Verlag, Berlin (1989).
- [186] R. Nagel and E. Sinestrari, Inhomogeneous Volterra integrodifferential equations for Hille-Yosida operators, in *Functional Analysis* (ed. K.D. Bierstedt, A. Pietsch, W.M. Ruess and D. Vogt), Lecture Notes Pure Appl. Math. **150**, Marcel Dekker (1994), 51-70.
- [187] J. van Neerven, The adjoint of a Semigroup of Linear Operators, Lecture Notes in Mathematics **1529**, Springer-Verlag (1992).
- [188] A.J. Nicholson, The balance of animal population, *J. Animal Ecol.* **2** (1933), 132-178.
- [189] A.J. Nicholson, An outline of the dynamics of animal populations, *Austral. J. Zoo.* **2** (1954), 9-65.

- [190] G. Nickel and A. Rhandi, On the essential spectral radius of semi-groups generated by perturbations of Hille-Yosida operators, *J. Diff. Integ. Equat.*, to appear.
- [191] R.M. Nisbet and W.S.C. Gurney, Population dynamics in a periodically varying environment, *J. Theor. Biol.* **56** (1976), 459-475.
- [192] R.M. Nisbet and W.S.C. Gurney, *Modelling Fluctuating Populations*, John Wiley and Sons (1982).
- [193] R. Nussbaum, Periodic solutions of some nonlinear autonomous functional differential equations, *Ann. Mat. Pura Appl.* **101** (1974), 263-306.
- [194] C.V. Pao, Systems of parabolic equations with continuous and discrete delays, *J. Math. Anal. Appl.* **205** (1997), 157-185.
- [195] A. Pazy, *Semigroups of linear operators and applications to partial differential equations*, Springer Verlag (1983).
- [196] E.R. Pianka, *Evolutionary Ecology*, Harper and Row, New York (1974).
- [197] C. Qian, Global attractivity in nonlinear delay differential equations, *J. Math. Anal. Appl.* **197** (1996), 529-547.
- [198] R. Redlinger, On Volterra's population equation with diffusion, *SIAM J. Math. Anal.* **16** (1985), 135-142.
- [199] A. Rhandi, Extrapolation methods to solve non-autonomous retarded differential equations, *Studia Math.* **126** (1997), 219-233.
- [200] A. Rhandi and R. Schnaubelt, Asymptotic behaviour of a non-autonomous population equation with diffusion in L^1 , *Disc. Cont. Dyn. Syst.* **5** (1999), 663-683.
- [201] A. Rhandi, Positivity and Stability for a population equation with diffusion on L^1 , *Positivity* **2** (1998), 101-113.
- [202] G. Rosen, Time delays produced by essential nonlinearity in population growth models, *Bull. Math. Biol.* **28** (1987), 253-256.
- [203] S. Ruan and D. Xiao, Stability of steady states and existence of traveling waves in a vector disease model, *Proceedings of the royal Society of Edinburgh: Sect. A - Mathematics* **134** (2004), 991-1011.
- [204] S.H. Saker and S. Agarwal, Oscillation and global attractivity in a periodic nicholson's blowflies model, *Math. Comput. Modelling* **35** (2002), 719-731.
- [205] L.F. Shampine and S. Thompson, Solving DDEs in MATLAB, *Appl. Numer. Math.* **37** (2001), 441-458.

- [206] H.C. Simpson, Stability of periodic solutions of integrodifferential equations, *SIAM J. Appl. Math.* **38** (1980), 341-363.
- [207] A. Schiaffino, On a diffusion Volterra equation, *Nonlinear Analysis - TMA* **3** (1979), 595-600.
- [208] A. Schiaffino and A. Tesei, Monotone methods and attractivity for Volterra integro-partial differential equations, *Proc. Royal Soc. Edinburgh* **89A** (1981), 135-142.
- [209] D. Schley and S.A. Gourley, Linear stability criteria for population models with periodic perturbed delays, *J. Math. Biol.* **40** (2000), 500-524.
- [210] A. Schoenflies, *Die Entwicklung der Lehre von den Punktmanigfaltigkeiten*. Bericht erstattet der Deutschen Mathematiker-Vereinigung, Teil II, Jahres-Berichte der DMV, Ergänzungsband II (1908).
- [211] A.L. Skubachevsky and H.O. Walther, *On Floquet multipliers for slowly oscillating periodic solutions of nonlinear functional differential equations*, *Trudy Moskov. Mat. Obshch.* **64** (2002), 3-54; English translation in: *Transactions of the Moscow Mathematical Society* (2003), 1-44.
- [212] H.L. Smith, *Monotone Dynamical Systems, An Introduction to the Theory of Competitive and Cooperative Systems*, Mathematical Surveys and Monographs **41**, Amer. Math. Soc., Providence (1995).
- [213] J.W.-H. So, J. Wu and Y. Yang, Numerical steady state and Hopf bifurcation analysis on the diffusive Nicholson's blowflies equation, *Appl. Math. Comput.* **111** (2000), 33-51.
- [214] J.W.-H. So and Y. Yang, Dirichlet problem for the diffusive Nicholson's blowflies equation, *J. Differential Equations* **150** (1998), 317-348.
- [215] J.W.-H. So and J.S. Yu, Global attractivity and uniform persistence in Nicholson's blowflies, *Differential Equations Dynamical Systems* **2** (1994), 11-18.
- [216] J.W.-H. So and J.S. Yu, On the uniform stability for a "food-limited" population model with time delay, *Proc. Royal Soc. Edinburgh* **125A** (1995), 991-1002.
- [217] J.W.-H. So and X. Zou, Traveling waves for the diffusive Nicholson's blowflies equation, *Appl. Math. Comput.* **122** (2001), 385-392.

- [218] H. Stech, The effect of time lags on the stability of the equilibrium state of a population growth equation, *J. Math. Biol.* **5** (1978), 115-120.
- [219] H. Steinlein and H.O. Walther, *Hyperbolic sets and shadowing for noninvertible maps*. In *Advanced Topics in the Theory of Dynamical Systems*, Fusco, G., Iannelli, M., and L. Salvadori eds., 219-234, Academic Press, New York (1989).
- [220] H. Steinlein and H.O. Walther, Hyperbolic sets, transversal homoclinic trajectories, and symbolic dynamics for C^1 -maps in Banach spaces, *J. Dynamical Systems and Differential Equations* **2** (1990), 325-365.
- [221] J. Sugie, On the stability for a population growth equation with time delay, *Proc. Royal Soc. Edinburgh* **120A** (1992), 179-184.
- [222] C.E. Taylor and R.R. Sokal, Oscillations in housefly population sizes due to time lags, *Ecology* **57** (1976), 1060-1067.
- [223] A. Tesei, Stability properties for partial Volterra integrodifferential equations, *Ann. Mat. Pura Appl.* **126** (1980), 103-115.
- [224] H.R. Thieme, Semiflows generated by Lipschitz perturbations of non-densely defined linear operators, *Diff. Integ. Equat.* **3** (1990), 1035-1066.
- [225] H.R. Thieme, The transition through stages with arbitrary length distributions, and applications in epidemics, In C. Castillo-Chavez, with S. Blower, P. van den Driessche, D. Kirschner, and A.-A. Yakubu, editors, *Mathematical Approaches for Emerging and Reemerging Infectious Diseases: Models, Methods, and Theory*, volume 126 of *IMA Volumes in Mathematics and its Applications*, pages 45-84 (2002).
- [226] C.C. Travis and G.F. Webb, Existence and stability, for partial functional differential equations, *Tran. Amer. Math. Soc.* **200** (1974), 395-418.
- [227] C.C. Travis and G.F. Webb, Existence, stability, and compactness in the α -norm for partial functional differential equations, *Tran. Amer. Math. Soc.* **240** (1978), 129-143.
- [228] P. van den Driessche, Some epidemiological models with delays, In *Differential Equations and Applications to Biology and to Industry (Claremont, CA, 1994)*, pages 507-520. World Sci. Publishing, River Edge, NJ (1996).
- [229] P. van den Driessche, Time delay in epidemic models, in C. Castillo-Chavez, with S. Blower, P. van den Driessche,

- D. Kirschner, and A.-A. Yakubu, editors, *Mathematical Approaches for Emerging and Reemerging Infectious Diseases: An Introduction*, volume 125 of *IMA Volumes in Mathematics and its Applications*, pages 119–128 (2002).
- [230] P. van den Driessche and J. Watmough, A simple SIS epidemic model with a backward bifurcation, *J. Math. Biol.* **40** (2000), 525–540.
- [231] Vanderbauwhede, A., and S.A. van Gils, Center manifolds and contractions on a scale of Banach spaces, *J. Functional Analysis* **71** (1987), 209–224.
- [232] F.F. Verhulst, Notice sur la loi que la population suit dans son accroissement, *Corr. Math. Phys.* **10** (1838), 113–121.
- [233] V. Volterra, Remarques sur la note de M. Régnier et Mlle. Lambin (Étude d'un cas d'antagonisme microbien), *C. R. Acad. Sci.* **199** (1934), 1684–1686.
- [234] H.O. Walther, Existence of a non-constant periodic solution of a nonlinear autonomous functional differential equation representing the growth of a single species population, *J. Math. Biol.* **1** (1975), 227–240.
- [235] H.O. Walther, Stable periodic motion of a system with state dependent delay, *Differential Integral Equations* **15** (2002), 923–944.
- [236] H.O. Walther, *Über Ejektivität und periodische Lösungen bei Funktionaldifferentialgleichungen mit verteilter Verzögerung*, Habilitation thesis, München (1977).
- [237] H.O. Walther, On instability, ω -limit sets and periodic solutions of nonlinear autonomous differential delay equations, in *Functional Differential Equations and Approximation of Fixed Points*, H.O. Peitgen and H.O. Walther eds., Lecture Notes in Math. **730**, 489–503, Springer, Heidelberg (1979).
- [238] H.O. Walther, Bifurcation from periodic solutions in functional differential equations, *Mathematische Zeitschrift* **182** (1983), 269–289.
- [239] H.O. Walther, *A differential delay equation with a planar attractor*, Accepted for the Proceedings of the Int. Conf. on Differential Equations Marrakech 1991.
- [240] H.O. Walther, *The two-dimensional attractor of $x'(t) = -\mu x(t) + f(x(t-1))$* , *Memoirs of the A.M.S.* Vol. 113, No. 544, 1995.
- [241] H.O. Walther, *Stable sets of periodic solutions of a delay differential equation*. To appear in *Proceedings of the Internat. Conf. on Differential Equations Marrakesh 1995*.

- [242] H.O. Walther, The singularities of an attractor of a delay differential equation, *Functional Differential Equations* **5** (1998), 513–548.
- [243] H.O. Walther, Contracting return maps for some delay differential equations, In *Topics in Functional Differential and Difference Equations*, T. Faria and P. Freitas eds., Fields Institute Communications series **29**, A.M.S., Providence (2001), 349–360.
- [244] H.O. Walther, Contracting return maps for monotone delayed feedback, *Discrete and Continuous Dynamical Systems* **7** (2001), 259–274.
- [245] H.O. Walther, Stable periodic motion of a system with state-dependent delay, *Differential and Integral Equations* **15** (2002), 923–944.
- [246] H.O. Walther, Stable periodic motion of a delayed spring, *Topological Methods in Nonlinear Analysis* **21** (2003), 1–28.
- [247] H.O. Walther, The solution manifold and C^1 -smoothness of solution operators for differential equations with state dependent delay, *J. Differential Eqs.* **195** (2003), 46–65.
- [248] H.O. Walther, Stable periodic motion of a system using echo for position control, *J. Dynamics and Differential Eqs.* **15** (2003), 143–223.
- [249] H.O. Walther, Smoothness properties of semiflows for differential equations with state dependent delay, Russian, in *Proceedings of the International Conference on Differential and Functional Differential Equations, Moscow, 2002* **1**, pp. 40–55, Moscow State Aviation Institute (MAI), Moscow (2003). English version: *Journal of the Mathematical Sciences* **124** (2004), 5193–5207.
- [250] H.O. Walther and M. Yebdri, Smoothness of the attractor of almost all solutions of a delay differential equation, *DISSERTATIONES MATHEMATICAE CCCLXVIII* (1997).
- [251] M. Wazewska-Czyzewska and A. Lasota, Mathematical problems of the dynamics of the red-blood cells system, *Ann. Polish Math. Soc. III Appl. Math.* **6** (1976), 23–40.
- [252] E. M. Wright, A non-linear difference-differential equation, *J. reine angew. Math.* **194** (1955), 66–87.
- [253] J. Wu, *Theory and Applications of Partial Functional Differential Equations*, Applied Mathematical Sciences **119**, Springer-Verlag, New York (1996).
- [254] Wu, J., *Stable phase-locked periodic solutions in a delay differential system*, *J. Differential Eqs.* **194** (2003), 237–286.

- [255] X. Xie, Uniqueness and stability of slowly oscillating periodic solutions of delay differential equations with bounded nonlinearity, *J. Dynamics and Differential Equations* **3** (1991), 515–540.
- [256] J. Yan and Q. Feng, Global attractivity and oscillation in a nonlinear delay equation, *Nonlinear Analysis - TMA* **43** (2001), 101–108.
- [257] Y. Yamada, Asymptotic behavior of solutions for semilinear Volterra diffusion equations, *Nonlinear Analysis - TMA* **21** (1993), 227–239.
- [258] K. Yoshida, The Hopf bifurcation and its stability for semilinear differential equations with time delay arising in ecology, *Hiroshima Math. J.* **12** (1982), 321–348.
- [259] J.S. Yu (1996), Global attractivity of the zero solution of a class of functional-differential equations and its applications, *Sci. China Ser. A* **39**, 225–237.
- [260] S.D. Zaidman, *Abstract differential equations*, Research notes in Mathematics (1994).
- [261] C. Zhang, Pseudo almost periodic functions and their applications, Ph.D thesis, University of Western Ontario (1992).
- [262] C. Zhang, Pseudo almost-periodic solutions of some differential equations, *J. Math. Anal. Appl.* **181** (1994), 62–76.
- [263] B. G. Zhang and K. Gopalsamy, Global attractivity and oscillations in a periodic delay-logistic equation, *J. Math. Anal. Appl.* **150** (1990), 274–283.
- [264] Lin Zhensheng, Theory of linear systems, *Ann. of Diff. Equ.* **6** (1990).

Index

- C^1 -submanifold, 416
- ω -limit set, 8
- 3-asymptotically stable, 180
- 3-completely-unstable, 180
- abscissa
 - of absolute convergence, 127
 - of convergence, 127
- abstract semilinear, 347, 349
- adjoint theory, 255, 263
- approximations, 146
- asymptotic stability, 424
- asymptotically stable, 180, 246
- attractor, 162
- Banach space, 14, 33, 146, 175, 233
- behavior, 31
- behaviour, 229
- bidual, 144
- bifurcation, 162, 243
- Bochner-integrable, 353
- Bogdanov-Takens, 243, 244
- Bogdanov-Takens singularity, 243
- bounded linear operators, 347
- bounded operators, 145
- bounded variation, 232
- boundedness, 38
- Cauchy problem, 156
- centre manifold, 166, 229, 242, 244, 246, 257, 261, 268, 271
- centre space, 230, 234, 255, 268
- characteristic
 - function, 53
 - matrix, 53
- characteristic equation, 255, 263
- characteristic operator, 254, 263
- characteristic roots, 247
- compact operator, 266
- compact operators, 264
- compact resolvent, 12
- compact resolvents, 419
- compact semigroup, 265
- complete flowline, 418
- completely continuous, 17
- completeness
 - of generalized eigenfunctions, 109
- complex inversion formula
 - for Laplace transforms, 129
- complex plane, 13
- complexification, 419
- convolution, 47, 128
- cyclic subspace, 84
- decomposition theory, 12
- degeneracy time, 111
- degenerate system, 110
- degenerate with respect to a vector, 110
- difference equation, 18
- differentiable, 8
- differential difference equations, 31
- diffusion, 260
- disease, 539, 541
- divisor
 - determinantal, 77
 - elementary, 77
- dual Banach space, 159
- dual semigroups, 144
- dual space, 145
- dynamical systems, 162
- Dyson-Phillips series, 529
- eigenvalue, 12
- ejective fixed point theorems, 12
- entire function
 - of exponential type, 129
- epidemic model, 539
- equilibrium point, 3
- exponential dichotomy, 175
- exponential distribution, 540, 543
- exponential growth, 356
- exponential type
 - of an entire function, 129
 - of an equation, 64
 - of an solution, 64
- exponentially bounded, 151, 351
- extrapolated semigroup, 532
- extrapolation, 529

- fixed point, 12
- Floquet multiplier, 451
- formal dual product, 175
- Fredholm alternative, 264, 266, 267
- Fredholm operators, 263
- fundamental matrix, 53
- fundamental solution, 144

- generalized eigenfunction, 72
- generalized eigenfunctions
 - completeness, 109
- generalized eigenspace, 13, 72, 232, 234, 264
- generator, 151, 351
- global attractor, 418
- Gronwall, 4
- Gronwall's lemma, 39

- h-asymptotic stability, 166
- Hartman-Grobman, 227
- Hilbert space, 253
- Hille-Yosida, 152, 350, 354
- homoclinic, 452
- homoclinic bifurcation, 246
- homoclinic loop, 452
- homotopy, 413
- Hopf, 247, 261, 271
- Hopf bifurcation, 162, 166, 246, 251
- Hutchinson equation, 253
- Hutchinson's equation, 481
- hyperbolic equilibrium, 227

- imaginary, 11
- immediately compact, 532
- Implicit Function Theorem, 416
- indicator function, 130
- infective, 546
- infective state, 543
- infinite dimensional Banach space, 347
- infinite dimensional spaces, 159
- infinite-dimensional space, 230
- infinitesimal generator, 12, 55, 68, 146, 233, 263, 348, 356
- initial value problem, 150
- integrated semigroup, 150, 352, 355
- integrated semigroups, 14, 144
- intraspecific competition, 488
- invariant C^1 -submanifold, 424
- invariant manifold, 234, 262
- invariant set, 8

- Laplace integral, 127
- Laplace transform, 127, 151, 351, 356
- Laplace-transform
 - of a solution, 47
- LaSalle invariance principle, 8
- Liapunov, 227

- linear autonomous equations, 12
- linear bounded operator, 153
- linear operator, 40
- linearization, 11, 230, 234
- Lipschitz, 352
- Lipschitz , 152
- logistic model, 478
- Lyapunov function, 180, 183, 483

- Malthus, 478
- manifold, 234
- maximal invariant set, 8
- module, 132
 - free, 132
- monodromy operator, 454

- negative feedback, 451
- negative orbit, 8
- neighborhood, 3
- Neutral functional differential equations, 16
- Nicholson's model, 487
- nonhomogeneous, 155
- nonlinear, 4
- nonlinear equation, 12
- nonlocal term, 31
- nonresonance, 242, 259
- normal form, 227, 232, 262

- periodic orbit, 416
- periodic orbits, 251
- periodic solution, 9, 416, 481
- periodic solutions, 179, 539
- phase space, 230, 234, 256, 267
- Poincaré procedure, 166
- population biology, 539
- Population dynamics, 260
- population dynamics, 349
- population size, 477
- positive feedback, 423
- positive orbit, 8

- quadratic form, 7
- qualitative, 15
- qualitative behaviour, 227

- random variable, 540
- Razumikhin functions, 7
- reflexive, 145
- resolvent, 355
- resolvent set
 - of an equation, 60
- Retarded Functional Differential Equations, 32

- saddle point, 15
- Schauder's fixed point theorem, 12
- semiflow, 255, 418, 424, 471

- semigroup, 12, 18, 143, 147, 348, 468
- semilinear, 354
- single species dynamics, 477
- slowly oscillating, 414
- small solution, 105
- solution semigroup, 55
- spectral, 266
- spectrum, 12, 355
 - of an equation, 60
- stability, 162
- stable, 103
 - asymptotically, 103
 - exponentially, 103
- stable manifold, 452
- state, 540
- state-dependent delay, 468, 470
- strong topology, 145
- strongly continuous, 348
- submanifold, 468
- submodule, 133
- sun-reflexive, 145, 147
- susceptible, 546

- Taylor expansions, 244
- translation semigroup, 150
- transversality condition, 480
- trivial equation, 147, 157

- uniform convergence, 33
- uniform convergence topology, 347
- unstable manifold, 12

- variation of constants formula, 4, 56, 144,
149, 529
- variational equation, 12, 40
- Verhulst, 478
- Volterra, 1, 350