

NEW AGE

SECOND EDITION

# PRODUCTION AND OPERATIONS MANAGEMENT

(With Skill Development, Caselets and Cases)

S. ANIL KUMAR | N. SURESH



NEW AGE INTERNATIONAL PUBLISHERS

**PRODUCTION  
AND  
OPERATIONS  
MANAGEMENT**  
(With Skill Development, Caselets and Cases)

**This page  
intentionally left  
blank**

# **PRODUCTION AND OPERATIONS MANAGEMENT**

**(With Skill Development, Caselets and Cases)**

Second Edition

**S. ANIL KUMAR**

*Professor*

Department of Commerce  
NMKRV College for Women  
Bangalore

**N. SURESH**

*Ph.D.*

*Associate Professor*

HOD of Industrial Engineering & Management  
MVJ College of Engineering  
Bangalore



PUBLISHING FOR ONE WORLD

**NEW AGE INTERNATIONAL (P) LIMITED, PUBLISHERS**

New Delhi • Bangalore • Chennai • Cochin • Guwahati • Hyderabad  
Jalandhar • Kolkata • Lucknow • Mumbai • Ranchi

Visit us at [www.newagepublishers.com](http://www.newagepublishers.com)

Copyright © 2008, 2006 New Age International (P) Ltd., Publishers  
Published by New Age International (P) Ltd., Publishers

---

All rights reserved.

No part of this ebook may be reproduced in any form, by photostat, microfilm, xerography, or any other means, or incorporated into any information retrieval system, electronic or mechanical, without the written permission of the publisher.  
*All inquiries should be emailed to [rights@newagepublishers.com](mailto:rights@newagepublishers.com)*

**ISBN : 978-81-224-2425-6**

**PUBLISHING FOR ONE WORLD**

**NEW AGE INTERNATIONAL (P) LIMITED, PUBLISHERS**

4835/24, Ansari Road, Daryaganj, New Delhi - 110002

Visit us at [www.newagepublishers.com](http://www.newagepublishers.com)

---

---

## PREFACE TO THE SECOND EDITION

---

---

The second edition of the book **Production and Operations Management** incorporates several suggestions offered by our colleagues and students all over the country.

In this edition we have endeavored to strengthen the basic characteristics of the book. The subject matter has been presented systematically in ten chapters, which can enable the reader to master the topics covered without any additional guidance. In keeping with the basic objective of making the learning of the 'Concept and Principles in Production and Operations Management', the following chapters have been revised as per the suggestions.

**Chapter 1 on Introduction to POM** was revised with the addition of Managing Global Operations with the concept of globalization. **Chapter 2 on Plant Location and Layout** was revised with locational models and the design of product and process layout. Service layout was also included. **Chapter 4 on Materials Management** was revised with the addition of special purchasing system. **Chapter 6 on Quality Control** was revised with the addition of ISO 14000 series along with the recognized bodies for ISO certification. **Chapter 8 on Maintenance Management** was revised with the concept of Total Preventive Maintenance.

The revised edition also contains **Caselets** which provides additional input to understand the subject with practical application of the techniques used in each chapter.

For the development of application skill of the theoretical knowledge of production and operation management, it is necessary to arrange for a visit or conduct the project work either by individual or group of students in a manufacturing or service organisation.

In this context the revised edition contains **skill development/practicals** in each chapter. For this purpose the students are advised to visit a Fast Food Restaurant like Pizza Hut or Pizza Corner for getting the information for the questions given under skill development in each chapter.

In addition to the caselet, cases are given to understand the entire concept of production and operations management at the end of the book.

Complete care has been taken to make the book error free. However, mistakes might have crept inadvertently. Readers finding any error are requested to bring it to our notice, for enabling us to rectify them in our future editions.

We are grateful to New Age International (P) Limited, Publishers, and the editorial department for their untiring effort to publish the book within a short span of time with a nice get up.

Our acknowledgements are also due to **Dr. Poornima Anil Kumar** and **Mrs. Bharathi Suresh**, without whose support and sacrifice this work would not have been completed by the deadline.

Finally, our acknowledgement is due to the Almighty who has blessed us with the knowledge, required for writing this book.

**AUTHORS**

---

---

## PREFACE TO THE FIRST EDITION

---

---

Production and Operations Management has been recognised as an important factor in a country's economic growth. The traditional view of manufacturing management is the concept of **Production Management** with the focus on economic efficiency in manufacturing. Later the new name **Operations Management** was identified, as service sector became more prominent. Rapid changes in technology has posed numerous opportunities and challenges which have resulted in enhancement of manufacturing capabilities through new materials, facilities, techniques and procedures. Hence, managing a service/production system has become a major challenge in the global competitive environment. Production and Operations Management leads the way for the organisations to achieve its goals with minimum effort. Hence the study of the subject at undergraduate and postgraduate level has more significance.

This book on 'Production and Operations Management' covers the complete syllabus of Bachelor of Business Management of Bangalore University, however the coverage is wide enough to include the requirements of the other Indian Universities and professional courses like MBA and Engineering.

Being student-friendly is the unique feature of this book. The subject matter has been presented systematically in ten chapters, which can enable the reader master the topics covered without any additional guidance.

Complete care has been taken to make the book error free. However, mistakes might have crept inadvertently. Readers finding any error are requested to bring it to our notice, for enabling us to rectify them in our future editions.

We are grateful to **Mr. Saumya Gupta**, Managing Director and **Mr. Babu V.R.** of New Age International (P) Ltd., for providing us this opportunity to share our knowledge with you.

Our acknowledgements are also due to **Dr. Poornima Anil Kumar** and **Mrs. Bharathi Suresh**, **Mr. K. Raghavendra** and **M.N. Ramachandra** without whose support and sacrifice this work would not have been completed by the deadline.

Finally, our acknowledgement is due to the Almighty who has blessed us with the knowledge, required for writing this book.

**AUTHORS**

---

---

# CONTENTS

---

---

<i>Preface to the Second Edition</i>	<i>v</i>
<i>Preface to the First Edition</i>	<i>vi</i>
<b>1 INTRODUCTION TO PRODUCTION AND OPERATION MANAGEMENT</b>	<b>1–21</b>
1.1 Introduction	1
1.2 Historical Evolution of Production and Operations Management	1
1.3 Concept of Production	3
1.4 Production System	3
1.4.1 Classification of Production System	4
1.5 Production Management	7
1.5.1 Objectives of Production Management	7
1.6 Operating System	8
1.6.1 Concept of Operations	8
1.6.2 Distinction between Manufacturing Operations and Service Operations	8
1.7 Operations Management	9
1.7.1 A Framework for Managing Operations	9
1.7.2 Objectives of Operations Management	11
1.8 Managing Global Operations	12
1.9 Scope of Production and Operations Management	13
<i>Exercises</i>	17
<i>Skill Development</i>	18
<i>Caselet</i>	18
<b>2 PLANT LOCATION AND LAYOUT</b>	<b>22–64</b>
2.1 Introduction and Meaning	22
2.2 Need for Selecting a Suitable Location	22
2.3 Factors Influencing Plant Location/Facility Location	27
2.3.1 General Locational Factors	27
2.3.2 Specific Locational Factors for Manufacturing Organisation	31
2.3.3 Specific Locational Factors for Service Organisation	32
2.4 Location Theories	33
2.5 Location Models	34
2.5.1 Factor Rating Method	34
2.5.2 Weighted Factor Rating Method	35
2.5.3 Load-distance Method	36
2.5.4 Centre of Gravity	38
2.5.5 Break Even Analysis	39



2.6	Locational Economics	41
2.7	Plant Layout	42
	2.7.1 Objectives of Plant Layout	42
	2.7.2 Principles of Plant Layout	43
2.8	Classification of Layout	43
	2.8.1 Process Layout	43
	2.8.2 Product Layout	44
	2.8.3 Combination Layout	45
	2.8.4 Fixed Position Layout	46
	2.8.5 Group Layout (or Cellular Layout)	46
2.9	Design of Product Layout	48
2.10	Design of Process Layout	52
2.11	Service Layout	55
2.12	Organisation of Physical Facilities	56
	<i>Exercises</i>	63
	<i>Skill Development</i>	64
<b>3</b>	<b>MATERIAL HANDLING</b>	<b>65–74</b>
3.1	Introduction and Meaning	65
3.2	Objectives of Material Handling	66
3.3	Principles of Material Handling	66
3.4	Selection of Material Handling Equipments	67
3.5	Evaluation of Material Handling System	68
3.6	Material Handling Equipments	69
3.7	Guidelines for Effective Utilisation of Material Handling Equipments	73
3.8	Relationship Between Plant Layout and Material Handling	73
	<i>Exercises</i>	74
	<i>Skill Development</i>	74
<b>4</b>	<b>MATERIALS MANAGEMENT</b>	<b>75–106</b>
4.1	Introduction and Meaning	75
4.2	Scope or Functions of Materials Management	75
4.3	Material Planning and Control	77
	4.3.1 Techniques of Material Planning	78
4.4	Purchasing	78
	4.4.1 Objectives of Purchasing	79
	4.4.2 Parameters of Purchasing	79
	4.4.3 Purchasing Procedure	82
	4.4.4 Selection of Suppliers	84
	4.4.5 Special Purchasing Systems	88
4.5	Stores Management	89
	4.5.1 Codification	90
4.6	Inventory Control or Management	91
	4.6.1 Meaning of Inventory	91

4.6.2	Reasons for Keeping Inventories	91
4.6.3	Meaning of Inventory Control	92
4.6.4	Objectives of Inventory Control	92
4.6.5	Benefits of Inventory Control	92
4.6.6	Techniques of Inventory Control	93
4.6.7	Inventory Model	94
4.7	Standardization	98
4.7.1	Advantages of Standardization	99
4.7.2	Disadvantages of Standardization	100
4.8	Simplification	100
4.8.1	Advantages of Simplification	100
4.9	Value Analysis	101
4.9.1	Value Analysis Framework	101
4.9.2	Steps in Value Analysis	101
4.10	Ergonomics (Human Engineering)	102
4.10.1	Objectives of Human Engineering	103
4.11	Just-In-Time (JIT) Manufacturing	103
4.11.1	Seven Wastes	103
4.11.2	Benefits of JIT	104
	<i>Exercises</i>	105
	<i>Skill Development</i>	105
	<i>Caselet</i>	106
<b>5</b>	<b>PRODUCTION PLANNING AND CONTROL</b>	<b>107–130</b>
5.1	Introduction and Meaning	107
5.2	Need for Production Planning and Control	108
5.3	Objectives of Production Planning and Control	109
5.4	Phases of Production Planning and Control	109
5.4.1	Planning Phase	110
5.4.2	Action Phase	111
5.4.3	Control Phase	111
5.5	Functions of Production Planning and Control	112
5.5.1	Parameters for PPC	113
5.6	Operations Planning and Scheduling Systems	114
5.7	Aggregate Planning	118
5.8	Master Production Schedule (MPS)	119
5.9	Material Requirement Planning (MRP)	120
5.9.1	Objectives of MRP	120
5.9.2	MRP System	120
5.10	Capacity Planning	121
5.10.1	Measurement of Capacity Planning	122
5.10.2	Process of Capacity Planning	123
5.11	Routing	124
5.11.1	Techniques of Routing	125

5.12	Scheduling	125
5.12.1	Principles of Scheduling	126
5.12.2	Inputs to Scheduling	126
5.12.3	Scheduling Strategies	126
5.12.4	Types of Scheduling	127
5.13	Scheduling Methodology	127
	<i>Exercises</i>	129
	<i>Skill Development</i>	129
	<i>Caselet</i>	130
<b>6</b>	<b>QUALITY CONTROL</b>	<b>131–170</b>
6.1	Introduction	131
6.2	Quality	132
6.2.1	Fundamental Factors Affecting Quality	132
6.3	Control	133
6.3.1	Need for Controlling Quality	133
6.4	Inspection	134
6.4.1	Objectives of Inspection	134
6.4.2	Purpose of Inspection	134
6.4.3	Types of Inspection	135
6.4.4	Methods of Inspection	137
6.4.5	Drawbacks of Inspection	137
6.5	Quality Control	137
6.5.1	Types of Quality Control	138
6.5.2	Steps in Quality Control	138
6.5.3	Objectives of Quality Control	139
6.5.4	Benefits of Quality Control	139
6.5.5	Seven Tools for Quality Control	139
6.5.6	Causes of Variation in Quality	143
6.6	Statistical Process Control	144
6.6.1	Control Charts	144
6.6.2	Acceptance Sampling	152
6.7	Quality Circles	154
6.7.1	Benefits of QC	154
6.8	Total Quality Management	155
6.8.1	Benefits of TQM	156
6.9	ISO 9000 Series	156
6.9.1	Objectives of ISO 9000 Series	156
6.9.2	Benefits of ISO 9000 Series	157
6.9.3	Steps in ISO 9000 Registration	157
6.10	Application ISO 9000: ISO 14000 Series	158
6.10.1	The Benefits of ISO 14000 Certification	159
	Annexure–I	159
	Annexure–II	162

	<i>Exercises</i>	163
	<i>Skill Development</i>	164
	<i>Caselet</i>	165
<b>7</b>	<b>WORK STUDY (TIME AND MOTION STUDY)</b>	<b>171–204</b>
7.1	Introduction	171
7.2	Productivity	172
	7.2.1 Factors Influencing Productivity	172
	7.2.2 Total Productivity Measure (TPM)	174
	7.2.3 Partial Productivity Measures (PPM)	174
	7.2.4 Productivity Improvement Techniques	175
7.3	Work Study	178
	7.3.1 Advantages of Work Study	179
7.4	Method Study	179
	7.4.1 Objectives of Method Study	180
	7.4.2 Scope of Method Study	180
	7.4.3 Steps or Procedure Involved in Methods Study	180
	7.4.4 Selection of the Job for Method Study	182
	7.4.5 Recording Techniques for Method Study	183
7.5	Motion Study	190
	7.5.1 Principles of Motion Study	190
	7.5.2 Recording Techniques of Motion Study	191
7.6	Work Measurement	192
	7.6.1 Objectives of Work Measurement	192
	7.6.2 Techniques of Work Measurement	192
7.7	Time Study	193
	7.7.1 Steps in Making Time Study	194
	7.7.2 Computation of Standard Time	194
	<i>Exercises</i>	199
	<i>Skill Development</i>	200
	<i>Caselet</i>	200
<b>8</b>	<b>MAINTENANCE MANAGEMENT</b>	<b>205–226</b>
8.1	Introduction and Meaning	205
8.2	Objectives of Maintenance	205
8.3	Types of Maintenance	206
	8.3.1 Breakdown (Reactive) Maintenance	206
	8.3.2 Preventive Maintenance	207
	8.3.3 Predictive Maintenance	208
8.4	Maintenance Planning	210
8.5	Maintenance Scheduling	211
8.6	Maintenance Schedule Techniques	212
	8.6.1 Modern Scientific Maintenance Methods	212

8.6.2	Six Sigma Maintenance	214
8.6.3	Enterprise Asset Management (EAM)	215
8.6.4	Lean Maintenance	215
8.6.5	Computer Aided Maintenance	215
8.7	Total Productive Maintenance (TPM)	216
8.7.1	Similarities and Differences between TQM and TPM	217
8.7.2	Pillars of TPM	217
	<i>Exercises</i>	226
	<i>Skill Development</i>	226
<b>9</b>	<b>WASTE MANAGEMENT</b>	<b>227–230</b>
9.1	Introduction and Meaning	227
9.2	Reasons for Generation and Accumulation of Obsolete, Surplus and Scrap Items	227
9.3	Identification and Control of Waste	228
9.4	Disposal of Scrap	229
	<i>Exercises</i>	230
	<i>Skill Development</i>	230
<b>10</b>	<b>AUTOMATION</b>	<b>231–249</b>
10.1	Introduction	231
10.2	Types of Automation	231
10.3	Computer Integrated Manufacturing	233
10.4	Reasons for Automation	234
10.5	Advantages of Automation	235
10.6	Disadvantages of Automation	235
10.7	Automation Strategies	236
10.8	Automated Flow Lines	237
10.9	Automated Guided Vehicles Systems	238
	10.9.1 Types of AGVS	239
	10.9.2 Applications of Automated Guided Vehicle Systems	239
10.10	Automated Storage/Retrieval Systems	240
	10.10.1 Types of AS/RS	241
	10.10.2 Basic Components of an AS/RS	241
10.11	Carousel Storage Systems	242
10.12	Carousel Storage Applications	242
	<i>Exercises</i>	243
	<i>Skill Development</i>	244
	<i>Caselet</i>	244
	GLOSSARY	250–258
	EXAMINATION QUESTION BANK	259–271

# 1

## INTRODUCTION TO PRODUCTION AND OPERATION MANAGEMENT

### CHAPTER OUTLINE

- |   |  |
|---|--|
| 1.1 <i>Introduction</i>   | 1.7 <i>Operations Management</i>                         |
| 1.2 <i>Historical Evolution of Production and Operations Management</i> | 1.8 <i>Managing Global Operations</i>                    |
| 1.3 <i>Concept of Production</i>  | 1.9 <i>Scope of Production and Operations Management</i> |
| 1.4 <i>Production System</i>  | • <i>Exercises</i>                                       |
| 1.5 <i>Production Management</i>  | • <i>Skill Development</i>                               |
| 1.6 <i>Operating System</i>   | • <i>Caselet</i>   |

### 1.1 INTRODUCTION

Production/operations management is the process, which combines and transforms various resources used in the production/operations subsystem of the organization into value added product/services in a controlled manner as per the policies of the organization. Therefore, it is that part of an organization, which is concerned with the transformation of a range of inputs into the required (products/services) having the requisite quality level.

The set of interrelated management activities, which are involved in manufacturing certain products, is called as **production management**. If the same concept is extended to services management, then the corresponding set of management activities is called as **operations management**.

### 1.2 HISTORICAL EVOLUTION OF PRODUCTION AND OPERATIONS MANAGEMENT

For over two centuries operations and production management has been recognised as an important factor in a country's economic growth.

The traditional view of manufacturing management began in eighteenth century when **Adam Smith** recognised the economic benefits of specialisation of labour. He recommended breaking of jobs down into subtasks and recognises workers to specialised tasks in which they would become highly skilled and efficient. In the early twentieth century, F.W. Taylor implemented Smith's theories and developed scientific management. From then till 1930, many techniques were developed prevailing the traditional view. Brief information about the contributions to manufacturing management is shown in the Table 1.1.

**TABLE 1.1 Historical summary of operations management**

<i>Date</i>	<i>Contribution</i>	<i>Contributor</i>
1776	Specialization of labour in manufacturing	Adam Smith
1799	Interchangeable parts, cost accounting	Eli Whitney and others
1832	Division of labour by skill; assignment of jobs by skill; basics of time study	Charles Babbage
1900	Scientific management time study and work study developed; dividing planning and doing of work	Frederick W. Taylor
1900	Motion of study of jobs	Frank B. Gilbreth
1901	Scheduling techniques for employees, machines jobs in manufacturing	Henry L. Gantt
1915	Economic lot sizes for inventory control	F.W. Harris
1927	Human relations; the Hawthorne studies	Elton Mayo
1931	Statistical inference applied to product quality: quality control charts	W.A. Shewart
1935	Statistical sampling applied to quality control: inspection sampling plans	H.F. Dodge & H.G. Roming
1940	Operations research applications in World War II	P.M. Blacker and others.
1946	Digital computer	John Mauchlly and J.P. Eckert
1947	Linear programming	G.B. Dantzig, Williams & others
1950	Mathematical programming, on-linear and stochastic processes	A. Charnes, W.W. Cooper & others
1951	Commercial digital computer: large-scale computations available.	Sperry Univac
1960	Organizational behaviour: continued study of people at work	L. Cummings, L. Porter
1970	Integrating operations into overall strategy and policy, Computer applications to manufacturing, Scheduling and control, Material requirement planning (MRP)	W. Skinner J. Orlicky and G. Wright
1980	Quality and productivity applications from Japan: robotics, CAD-CAM	W.E. Deming and J. Juran.

**Production management** becomes the acceptable term from 1930s to 1950s. As F.W. Taylor's works become more widely known, managers developed techniques that focussed on economic efficiency in manufacturing. Workers were studied in great detail to eliminate wasteful efforts and achieve greater efficiency. At the same time, psychologists, socialists and

other social scientists began to study people and human behaviour in the working environment. In addition, economists, mathematicians, and computer socialists contributed newer, more sophisticated analytical approaches.

With the 1970s emerges two distinct changes in our views. The most obvious of these, reflected in the new name **operations management** was a shift in the service and manufacturing sectors of the economy. As service sector became more prominent, the change from ‘production’ to ‘operations’ emphasized the broadening of our field to service organizations. The second, more suitable change was the beginning of an emphasis on synthesis, rather than just analysis, in management practices.

### 1.3 CONCEPT OF PRODUCTION

Production function is that part of an organization, which is concerned with the transformation of a range of inputs into the required outputs (products) having the requisite quality level.

Production is defined as “*the step-by-step conversion of one form of material into another form through chemical or mechanical process to create or enhance the utility of the product to the user.*” Thus production is a value addition process. At each stage of processing, there will be value addition.

Edwood Buffa defines production as ‘*a process by which goods and services are created*’.

Some examples of production are: manufacturing custom-made products like, boilers with a specific capacity, constructing flats, some structural fabrication works for selected customers, etc., and manufacturing standardized products like, car, bus, motor cycle, radio, television, etc.

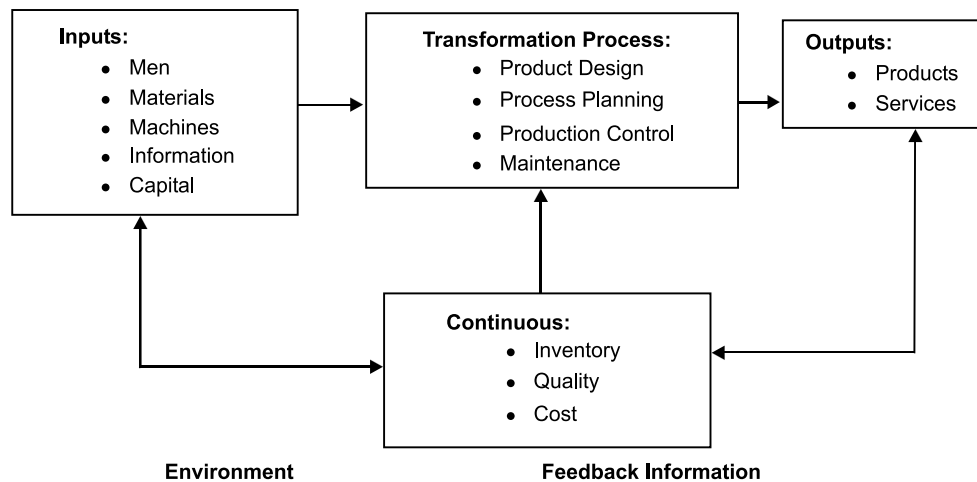

Fig. 1.1 Schematic production system

### 1.4 PRODUCTION SYSTEM

The production system of an organization is that part, which produces products of an organization. It is that activity whereby resources, flowing within a defined system, are combined and transformed in a controlled manner to add value in accordance with the policies communicated by management. A simplified production system is shown above.



The production system has the following characteristics:

1. Production is an organized activity, so every production system has an objective.
2. The system transforms the various inputs to useful outputs.
3. It does not operate in isolation from the other organization system.
4. There exists a feedback about the activities, which is essential to control and improve system performance.

### 1.4.1 Classification of Production System

Production systems can be classified as Job Shop, Batch, Mass and Continuous Production systems.

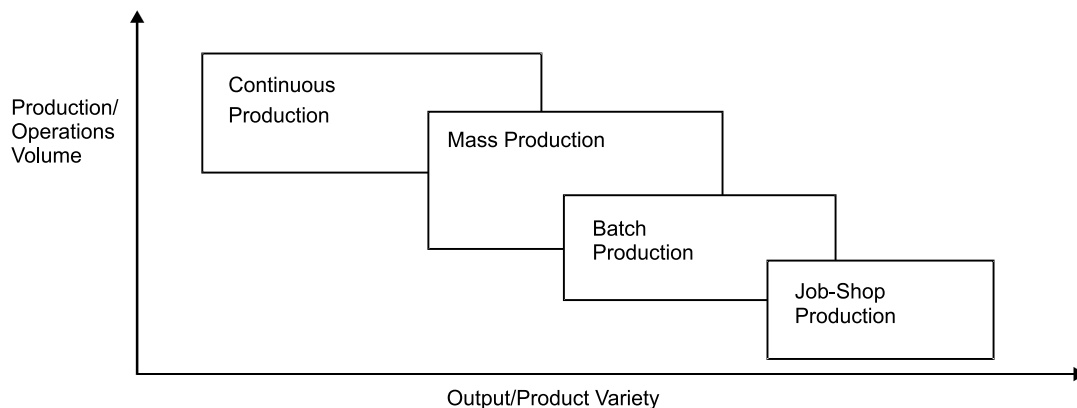

**Fig. 1.2** Classification of production systems

#### **JOB SHOP PRODUCTION**

Job shop production are characterised by manufacturing of one or few quantity of products designed and produced as per the specification of customers within prefixed time and cost. The distinguishing feature of this is low volume and high variety of products.

A job shop comprises of general purpose machines arranged into different departments. Each job demands unique technological requirements, demands processing on machines in a certain sequence.

#### **Characteristics**

The Job-shop production system is followed when there is:

1. High variety of products and low volume.
2. Use of general purpose machines and facilities.
3. Highly skilled operators who can take up each job as a challenge because of uniqueness.
4. Large inventory of materials, tools, parts.
5. Detailed planning is essential for sequencing the requirements of each product, capacities for each work centre and order priorities.

**Advantages**

Following are the advantages of job shop production:

1. Because of general purpose machines and facilities variety of products can be produced.
2. Operators will become more skilled and competent, as each job gives them learning opportunities.
3. Full potential of operators can be utilised.
4. Opportunity exists for creative methods and innovative ideas.

**Limitations**

Following are the limitations of job shop production:

1. Higher cost due to frequent set up changes.
2. Higher level of inventory at all levels and hence higher inventory cost.
3. Production planning is complicated.
4. Larger space requirements.

**BATCH PRODUCTION**

Batch production is defined by American Production and Inventory Control Society (APICS) “*as a form of manufacturing in which the job passes through the functional departments in lots or batches and each lot may have a different routing.*” It is characterised by the manufacture of limited number of products produced at regular intervals and stocked awaiting sales.

**Characteristics**

Batch production system is used under the following circumstances:

1. When there is shorter production runs.
2. When plant and machinery are flexible.
3. When plant and machinery set up is used for the production of item in a batch and change of set up is required for processing the next batch.
4. When manufacturing lead time and cost are lower as compared to job order production.

**Advantages**

Following are the advantages of batch production:

1. Better utilisation of plant and machinery.
2. Promotes functional specialisation.
3. Cost per unit is lower as compared to job order production.
4. Lower investment in plant and machinery.
5. Flexibility to accommodate and process number of products.
6. Job satisfaction exists for operators.

**Limitations**

Following are the limitations of batch production:

1. Material handling is complex because of irregular and longer flows.
2. Production planning and control is complex.

3. Work in process inventory is higher compared to continuous production.
4. Higher set up costs due to frequent changes in set up.

### **MASS PRODUCTION**

Manufacture of discrete parts or assemblies using a continuous process are called mass production. This production system is justified by very large volume of production. The machines are arranged in a line or product layout. Product and process standardisation exists and all outputs follow the same path.

#### **Characteristics**

Mass production is used under the following circumstances:

1. Standardisation of product and process sequence.
2. Dedicated special purpose machines having higher production capacities and output rates.
3. Large volume of products.
4. Shorter cycle time of production.
5. Lower in process inventory.
6. Perfectly balanced production lines.
7. Flow of materials, components and parts is continuous and without any back tracking.
8. Production planning and control is easy.
9. Material handling can be completely automatic.

#### **Advantages**

Following are the advantages of mass production:

1. Higher rate of production with reduced cycle time.
2. Higher capacity utilisation due to line balancing.
3. Less skilled operators are required.
4. Low process inventory.
5. Manufacturing cost per unit is low.

#### **Limitations**

Following are the limitations of mass production:

1. Breakdown of one machine will stop an entire production line.
2. Line layout needs major change with the changes in the product design.
3. High investment in production facilities.
4. The cycle time is determined by the slowest operation.

### **CONTINUOUS PRODUCTION**

Production facilities are arranged as per the sequence of production operations from the first operations to the finished product. The items are made to flow through the sequence of operations through material handling devices such as conveyors, transfer devices, etc.

#### **Characteristics**

Continuous production is used under the following circumstances:

1. Dedicated plant and equipment with zero flexibility.

2. Material handling is fully automated.
3. Process follows a predetermined sequence of operations.
4. Component materials cannot be readily identified with final product.
5. Planning and scheduling is a routine action.

### Advantages

Following are the advantages of continuous production:

1. Standardisation of product and process sequence.
2. Higher rate of production with reduced cycle time.
3. Higher capacity utilisation due to line balancing.
4. Manpower is not required for material handling as it is completely automatic.
5. Person with limited skills can be used on the production line.
6. Unit cost is lower due to high volume of production.

### Limitations

Following are the limitations of continuous production:

1. Flexibility to accommodate and process number of products does not exist.
2. Very high investment for setting flow lines.
3. Product differentiation is limited.

## 1.5 PRODUCTION MANAGEMENT

Production management is a process of planning, organizing, directing and controlling the activities of the production function. It combines and transforms various resources used in the production subsystem of the organization into value added product in a controlled manner as per the policies of the organization.

*E.S. Buffa* defines production management as, “**Production management** deals with decision making related to production processes so that the resulting goods or services are produced according to specifications, in the amount and by the schedule demanded and out of minimum cost.”

### 1.5.1 Objectives of Production Management

The objective of the production management is ‘to produce goods services of right quality and quantity at the right time and right manufacturing cost’.

#### 1. RIGHT QUALITY

The quality of product is established based upon the customers needs. The right quality is not necessarily best quality. It is determined by the cost of the product and the technical characteristics as suited to the specific requirements.

#### 2. RIGHT QUANTITY

The manufacturing organization should produce the products in right number. If they are produced in excess of demand the capital will block up in the form of inventory and if the quantity is produced in short of demand, leads to shortage of products.

### 3. RIGHT TIME

Timeliness of delivery is one of the important parameter to judge the effectiveness of production department. So, the production department has to make the optimal utilization of input resources to achieve its objective.

### 4. RIGHT MANUFACTURING COST

Manufacturing costs are established before the product is actually manufactured. Hence, all attempts should be made to produce the products at pre-established cost, so as to reduce the variation between actual and the standard (pre-established) cost.

## 1.6 OPERATING SYSTEM

Operating system converts inputs in order to provide outputs which are required by a customer. It converts physical resources into outputs, the function of which is to satisfy customer wants *i.e.*, to provide some utility for the customer. In some of the organization the product is a physical good (hotels) while in others it is a service (hospitals). Bus and taxi services, tailors, hospital and builders are the examples of an operating system.

**Everett E. Adam & Ronald J. Ebert** define operating system as, “*An operating system (function) of an organization is the part of an organization that produces the organization’s physical goods and services.*”

**Ray Wild** defines operating system as, “*An operating system is a configuration of resources combined for the provision of goods or services.*”

### 1.6.1 Concept of Operations

An operation is defined in terms of the mission it serves for the organization, technology it employs and the human and managerial processes it involves. Operations in an organization can be categorised into manufacturing operations and service operations. Manufacturing operations is a conversion process that includes manufacturing yields a tangible output: a product, whereas, a conversion process that includes service yields an intangible output: a deed, a performance, an effort.

### 1.6.2 Distinction between Manufacturing Operations and Service Operations

Following characteristics can be considered for distinguishing manufacturing operations with service operations:

1. Tangible/Intangible nature of output
2. Consumption of output
3. Nature of work (job)
4. Degree of customer contact
5. Customer participation in conversion
6. Measurement of performance.

Manufacturing is characterised by tangible outputs (products), outputs that customers consume overtime, jobs that use less labour and more equipment, little customer contact, no customer participation in the conversion process (in production), and sophisticated methods for measuring production activities and resource consumption as product are made.

Service is characterised by intangible outputs, outputs that customers consumes immediately, jobs that use more labour and less equipment, direct consumer contact, frequent customer participation in the conversion process, and elementary methods for measuring conversion activities and resource consumption. Some services are equipment based namely rail-road services, telephone services and some are people based namely tax consultant services, hair styling.

## 1.7 OPERATIONS MANAGEMENT

### 1.7.1 A Framework for Managing Operations

Managing operations can be enclosed in a frame of general management function as shown in Fig. 1.3. Operation managers are concerned with planning, organizing, and controlling the activities which affect human behaviour through models.

#### PLANNING

*Activities that establishes a course of action and guide future decision-making is planning.* The operations manager defines the objectives for the operations subsystem of the organization, and the policies, and procedures for achieving the objectives. This stage includes clarifying the role and focus of operations in the organization's overall strategy. It also involves product planning, facility designing and using the conversion process.

#### ORGANIZING

*Activities that establishes a structure of tasks and authority.* Operation managers establish a structure of roles and the flow of information within the operations subsystem. They determine the activities required to achieve the goals and assign authority and responsibility for carrying them out.

#### CONTROLLING

*Activities that assure the actual performance in accordance with planned performance.* To ensure that the plans for the operations subsystems are accomplished, the operations manager must exercise control by measuring actual outputs and comparing them to planned operations management. Controlling costs, quality, and schedules are the important functions here.

#### BEHAVIOUR

Operation managers are concerned with how their efforts to plan, organize, and control affect human behaviour. They also want to know how the behaviour of subordinates can affect management's planning, organizing, and controlling actions. Their interest lies in decision-making behaviour.

#### MODELS

As operation managers plan, organise, and control the conversion process, they encounter many problems and must make many decisions. They can simplify their difficulties using models like *aggregate planning models* for examining how best to use existing capacity in short-term, *break even analysis* to identify break even volumes, *linear programming and computer simulation* for capacity utilisation, *decision tree analysis* for long-term capacity problem of facility expansion, *simple median model* for determining best locations of facilities etc.

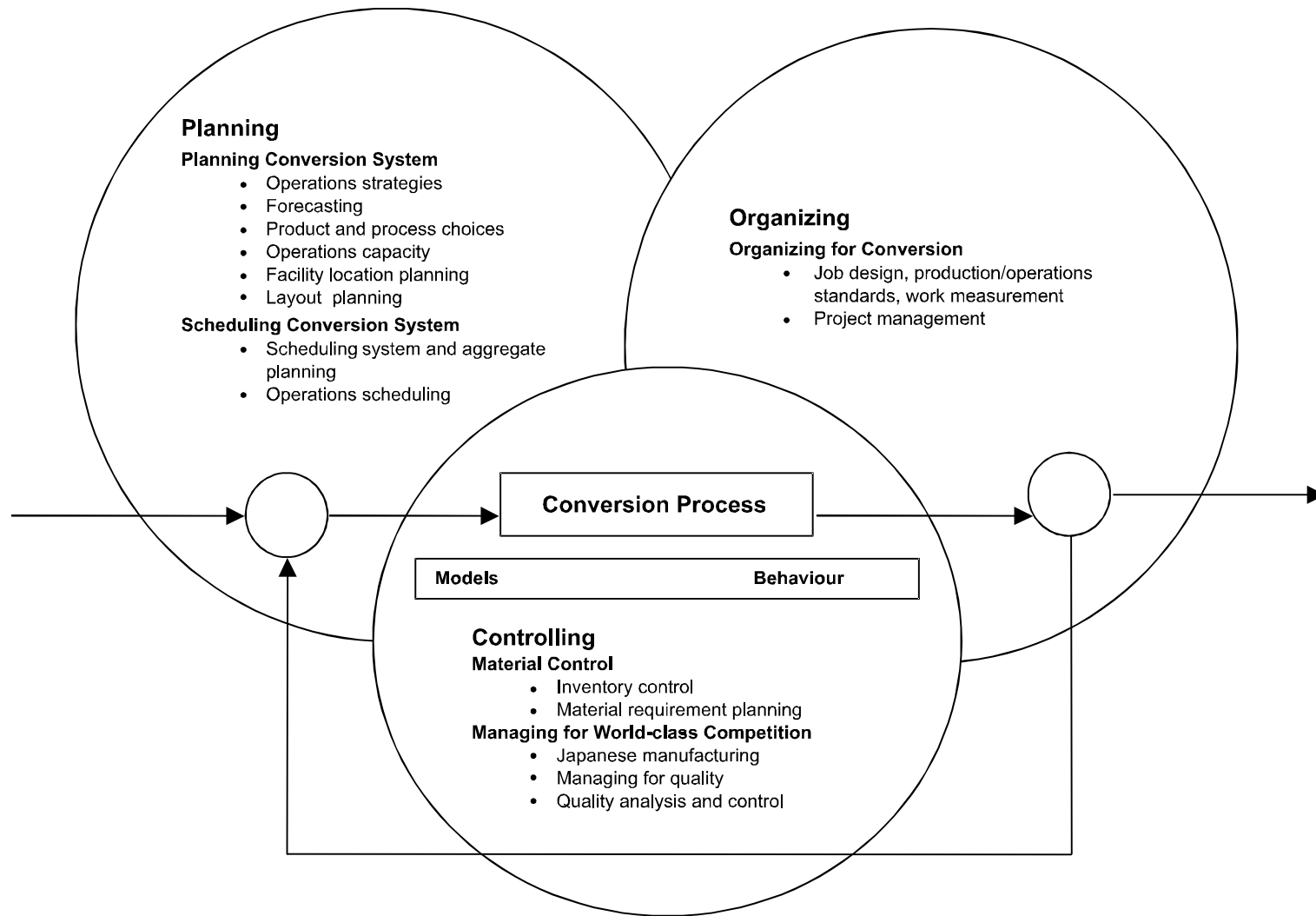

**Fig. 1.3** *General model for managing operations*

### 1.7.2 Objectives of Operations Management

Objectives of operations management can be categorised into customer service and resource utilisation.

#### CUSTOMER SERVICE

The first objective of operating systems is the customer service to the satisfaction of customer wants. Therefore, customer service is a key objective of operations management. The operating system must provide something to a specification which can satisfy the customer in terms of cost and timing. Thus, primary objective can be satisfied by providing the ‘right thing at a right price at the right time’.

These aspects of customer service—specification, cost and timing—are described for four functions in Table 1.2. They are the principal sources of customer satisfaction and must, therefore, be the principal dimension of the customer service objective for operations managers.

**TABLE 1.2 Aspects of customer service**

<i>Principal function</i>	<i>Principal customer wants</i>	
	<i>Primary considerations</i>	<i>Other considerations</i>
Manufacture	Goods of a given, requested or acceptable specification	<i>Cost, i.e.</i> , purchase price or cost of obtaining goods. <i>Timing, i.e.</i> , delivery delay from order or request to receipt of goods.
Transport	Management of a given, requested or acceptable specification	<i>Cost, i.e.</i> , cost of movements. <i>Timing, i.e.</i> , 1. Duration or time to move. 2. Wait or delay from requesting to its commencement.
Supply	Goods of a given, requested or acceptable specification	<i>Cost, i.e.</i> , purchase price or cost of obtaining goods. <i>Timing, i.e.</i> , delivery delay from order or request to receipt of goods.
Service	Treatment of a given, requested or acceptable specification	<i>Cost, i.e.</i> , cost of movements. <i>Timing, i.e.</i> , 1. Duration or time required for treatment. 2. Wait or delay from requesting treatment to its commencement.

Generally an organization will aim reliably and consistently to achieve certain standards and operations manager will be influential in attempting to achieve these standards. Hence, this objective will influence the operations manager’s decisions to achieve the required customer service.

#### RESOURCE UTILISATION

Another major objective of operating systems is to utilise resources for the satisfaction of customer wants effectively, *i.e.*, customer service must be provided with the achievement of



effective operations through efficient use of resources. Inefficient use of resources or inadequate customer service leads to commercial failure of an operating system.

Operations management is concerned essentially with the utilisation of resources, *i.e.*, obtaining maximum effect from resources or minimising their loss, under utilisation or waste. The extent of the utilisation of the resources' potential might be expressed in terms of the proportion of available time used or occupied, space utilisation, levels of activity, etc. Each measure indicates the extent to which the potential or capacity of such resources is utilised. This is referred as the objective of resource utilisation.

Operations management is also concerned with the achievement of both satisfactory customer service and resource utilisation. An improvement in one will often give rise to deterioration in the other. Often both cannot be maximised, and hence a satisfactory performance must be achieved on both objectives. All the activities of operations management must be tackled with these two objectives in mind, and many of the problems will be faced by operations managers because of this conflict. Hence, operations managers must attempt to balance these basic objectives.

Table 1.3 summarises the twin objectives of operations management. The type of balance established both between and within these basic objectives will be influenced by market considerations, competitions, the strengths and weaknesses of the organization, etc. Hence, the operations managers should make a contribution when these objectives are set.

**TABLE 1.3 The twin objectives of operations management**

<p><b>The customer service objective.</b> To provide agreed/adequate levels of customer service (and hence customer satisfaction) by providing goods or services with the right specification, at the right cost and at the right time.</p>	<p><b>The resource utilisation objective.</b> To achieve adequate levels of resource utilisation (or productivity) <i>e.g.</i>, to achieve agreed levels of utilisation of materials, machines and labour.</p>
---	--

## 1.8 MANAGING GLOBAL OPERATIONS

The term 'globalization' describes businesses' deployment of facilities and operations around the world. Globalization can be defined as a process in which geographic distance becomes a factor of diminishing importance in the establishment and maintenance of cross border economic, political and socio-cultural relations. It can also be defined as worldwide drive toward a globalized economic system dominated by supranational corporate trade and banking institutions that are not accountable to democratic processes or national governments.

There are four developments, which have spurred the trend toward globalization. These are:

1. Improved transportation and communication technologies;
2. Opened financial systems;
3. Increased demand for imports; and
4. Reduced import quotas and other trade barriers.

When a firm sets up facilities abroad it involve some added complexities in its operation. Global markets impose new standards on quality and time. Managers should not think about domestic markets first and then global markets later, rather it could be think globally and act

locally. Also, they must have a good understanding of their competitors. Some other important challenges of managing multinational operations include other languages and customs, different management style, unfamiliar laws and regulations, and different costs.

Managing global operations would focus on the following key issues:

- To acquire and properly utilize the following concepts and those related to global operations, supply chain, logistics, etc.
- To associate global historical events to key drivers in global operations from different perspectives.
- To develop criteria for conceptualization and evaluation of different global operations.
- To associate success and failure cases of global operations to political, social, economical and technological environments.
- To envision trends in global operations.
- To develop an understanding of the world vision regardless of their country of origin, residence or studies in a respectful way of perspectives of people from different races, studies, preferences, religion, politic affiliation, place of origin, etc.

## 1.9

### SCOPE OF PRODUCTION AND OPERATIONS MANAGEMENT

Production and operations management concern with the conversion of inputs into outputs, using physical resources, so as to provide the desired utilities to the customer while meeting the other organizational objectives of effectiveness, efficiency and adoptability. It distinguishes itself from other functions such as personnel, marketing, finance, etc., by its primary concern for 'conversion by using physical resources.' Following are the activities which are listed under production and operations management functions:

1. Location of facilities
2. Plant layouts and material handling
3. Product design
4. Process design
5. Production and planning control
6. Quality control
7. Materials management
8. Maintenance management.

#### LOCATION OF FACILITIES

Location of facilities for operations is a long-term capacity decision which involves a long term commitment about the geographically static factors that affect a business organization. It is an important strategic level decision-making for an organization. It deals with the questions such as 'where our main operations should be based?'

The selection of location is a key-decision as large investment is made in building plant and machinery. An improper location of plant may lead to waste of all the investments made in plant and machinery equipments. Hence, location of plant should be based on the company's expansion

plan and policy, diversification plan for the products, changing sources of raw materials and many other factors. The purpose of the location study is to find the optimal location that will result in the greatest advantage to the organization.

### **PLANT LAYOUT AND MATERIAL HANDLING**

Plant layout refers to the physical arrangement of facilities. It is the configuration of departments, work centres and equipment in the conversion process. The overall objective of the plant layout is to design a physical arrangement that meets the required output quality and quantity most economically.

According to **James Moore**, “*Plant layout is a plan of an optimum arrangement of facilities including personnel, operating equipment, storage space, material handling equipments and all other supporting services along with the design of best structure to contain all these facilities*”.

‘Material Handling’ refers to the ‘moving of materials from the store room to the machine and from one machine to the next during the process of manufacture’. It is also defined as the ‘art and science of moving, packing and storing of products in any form’. It is a specialised activity for a modern manufacturing concern, with 50 to 75% of the cost of production. This cost can be reduced by proper selection, operation and maintenance of material handling devices. Material handling devices increase the output, improve quality, speed up the deliveries and decrease the cost of production. Hence, material handling is a prime consideration in the designing new plant and several existing plants.

### **PRODUCT DESIGN**

Product design deals with conversion of ideas into reality. Every business organization has to design, develop and introduce new products as a survival and growth strategy. Developing the new products and launching them in the market is the biggest challenge faced by the organizations. The entire process of need identification to physical manufacture of product involves three functions: marketing, product development, manufacturing. Product development translates the needs of customers given by marketing into technical specifications and designing the various features into the product to these specifications. Manufacturing has the responsibility of selecting the processes by which the product can be manufactured. Product design and development provides link between marketing, customer needs and expectations and the activities required to manufacture the product.

### **PROCESS DESIGN**

Process design is a macroscopic decision-making of an overall process route for converting the raw material into finished goods. These decisions encompass the selection of a process, choice of technology, process flow analysis and layout of the facilities. Hence, the important decisions in process design are to analyse the workflow for converting raw material into finished product and to select the workstation for each included in the workflow.

### **PRODUCTION PLANNING AND CONTROL**

Production planning and control can be defined as the process of planning the production in advance, setting the exact route of each item, fixing the starting and finishing dates for each item, to give production orders to shops and to follow up the progress of products according to orders.

The principle of production planning and control lies in the statement ‘First Plan Your Work and then Work on Your Plan’. Main functions of production planning and control includes planning, routing, scheduling, dispatching and follow-up.

**Planning** is deciding in advance what to do, how to do it, when to do it and who is to do it. Planning bridges the gap from where we are, to where we want to go. It makes it possible for things to occur which would not otherwise happen.

**Routing** may be defined as the selection of path which each part of the product will follow, which being transformed from raw material to finished products. Routing determines the most advantageous path to be followed from department to department and machine to machine till raw material gets its final shape.

**Scheduling** determines the programme for the operations. Scheduling may be defined as ‘the fixation of time and date for each operation’ as well as it determines the sequence of operations to be followed.

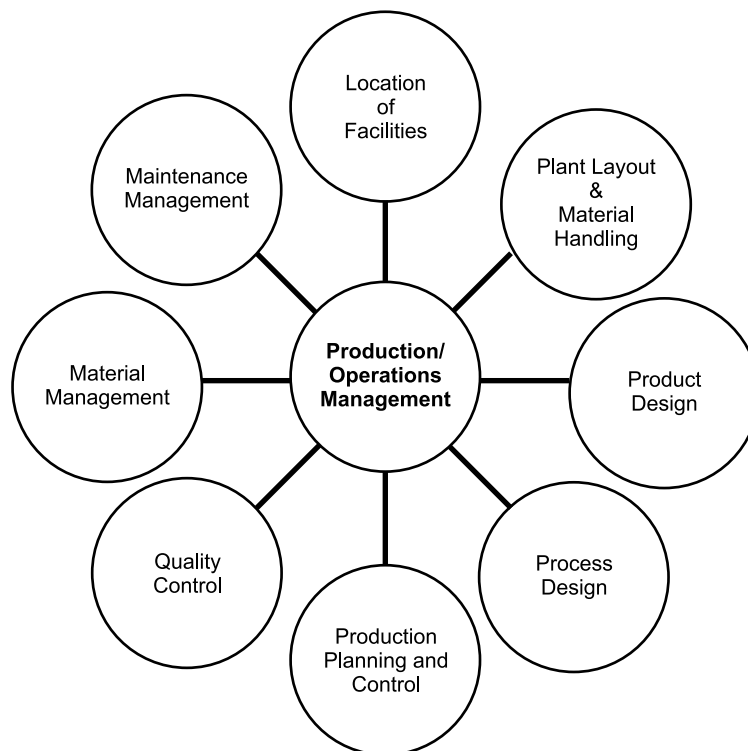

**Fig. 1.4** *Scope of production and operations management*

**Dispatching** is concerned with the starting the processes. It gives necessary authority so as to start a particular work, which has already been planned under ‘Routing’ and ‘Scheduling’. Therefore, dispatching is ‘release of orders and instruction for the starting of production for any item in acceptance with the route sheet and schedule charts’.

The function of **follow-up** is to report daily the progress of work in each shop in a prescribed proforma and to investigate the causes of deviations from the planned performance.

### QUALITY CONTROL

Quality Control (QC) may be defined as 'a system that is used to maintain a desired level of quality in a product or service'. It is a systematic control of various factors that affect the quality of the product. Quality control aims at prevention of defects at the source, relies on effective feed back system and corrective action procedure.

Quality control can also be defined as 'that industrial management technique by means of which product of uniform acceptable quality is manufactured'. It is the entire collection of activities which ensures that the operation will produce the optimum quality products at minimum cost.

The main objectives of quality control are:

- To improve the companies income by making the production more acceptable to the customers *i.e.*, by providing long life, greater usefulness, maintainability, etc.
- To reduce companies cost through reduction of losses due to defects.
- To achieve interchangeability of manufacture in large scale production.
- To produce optimal quality at reduced price.
- To ensure satisfaction of customers with productions or services or high quality level, to build customer goodwill, confidence and reputation of manufacturer.
- To make inspection prompt to ensure quality control.
- To check the variation during manufacturing.

### MATERIALS MANAGEMENT

Materials management is that aspect of management function which is primarily concerned with the acquisition, control and use of materials needed and flow of goods and services connected with the production process having some predetermined objectives in view.

The main objectives of materials management are:

- To minimise material cost.
- To purchase, receive, transport and store materials efficiently and to reduce the related cost.
- To cut down costs through simplification, standardisation, value analysis, import substitution, etc.
- To trace new sources of supply and to develop cordial relations with them in order to ensure continuous supply at reasonable rates.
- To reduce investment tied in the inventories for use in other productive purposes and to develop high inventory turnover ratios.

### MAINTENANCE MANAGEMENT

In modern industry, equipment and machinery are a very important part of the total productive effort. Therefore, their idleness or downtime becomes are very expensive. Hence, it is very important that the plant machinery should be properly maintained.

The main objectives of maintenance management are:

1. To achieve minimum breakdown and to keep the plant in good working condition at the lowest possible cost.
2. To keep the machines and other facilities in such a condition that permits them to be used at their optimal capacity without interruption.
3. To ensure the availability of the machines, buildings and services required by other sections of the factory for the performance of their functions at optimal return on investment.

## EXERCISES

### Section A

1. What do you mean by 'Production'?
2. What do you mean by production system?
3. Mention the different types of production systems.
4. What is job shop production?
5. What is batch production?
6. What is mass production?
7. What is continuous production?
8. Mention any four advantages of job shop production.
9. Mention any four limitations of job shop production.
10. Mention any four advantages of batch production.
11. Mention any four limitations of batch production.
12. Mention any four advantages of mass production.
13. Mention any four limitations of mass production.
14. Mention any four advantages of continuous production.
15. Mention any four limitations of continuous production.
16. Define production management.
17. Mention any four objectives of production management.
18. Define operating system.
19. How do you manage operations?
20. What do you mean by operations?
21. What do you mean by manufacturing operations?
22. What do you mean by service operations?
23. What do you mean by 'globalization'?

### Section B

1. Briefly explain the production system and its characteristics.
2. What is job shop production? What are its characteristics, advantages and limitations?
3. What is batch production? What are its characteristics, advantages and limitations?
4. What is batch production? What are its characteristics, advantages and limitations?
5. What is mass production? What are its characteristics, advantages and limitations?
6. What is continuous production? What are its characteristics, advantages and limitations?
7. Explain in brief the objectives of production management.
8. Explain in brief the objectives of operations management.
9. Distinguish between manufacturing operations and service operations.
10. Explain the key issues to be considered for managing global operations.

### Section C

1. Explain the different types of production systems.
2. Explain the framework of managing operations.
3. Explain the scope of production and operations management.

### Skill Development

Visit a fast food restaurant like Pizza hut, Pizza corner to understand the concept of this chapter by getting the information for the following questions.

1. Identify the type of production system followed.
2. Check how production system is managed.
3. Find out utilisation of the resources namely manpower, capacity and material.
4. How the customer services is rendered [feedback system exist or not]

### CASELET

#### **SHEENA**

Sheena had worked for the same Fortune 500 Company for most 15 years. Although the company had gone through some tough times, things were starting to turn around. Customer orders were up, and quality and productivity had improved dramatically from what they had been only a few years earlier due company wide quality improvement program. So, it comes as a real shock to Sheena and about 400 of her co-workers when they were suddenly terminated following the new CEO's decision to downsize the company.

After recovering from the initial shock, Sheena tried to find employment elsewhere. Despite her efforts, after eight months of searching she was no closer to finding a job than the day she started. Her funds were being depleted and she was getting more discouraged. There was one bright spot, though: She was able to bring in a little money by mowing lawns for her neighbors. She got involved quite by chance when she heard one neighbor remark that now that his children were on their own, nobody was around to cut the grass. Almost jokingly, Sheena asked him how much he'd be willing to pay. Soon Sheena was mowing the lawns of five neighbors. Other neighbors wanted her to work on their lawns, but she didn't feel that she could spare any more time from her job search.

However, as the rejection letters began to pile up, Sheena knew she had to make an important decision in her life. On a rainy Tuesday morning, she decided to go into business for herself taking care of neighborhood lawns. She was relieved to give up the stress of job hunting, and she was excited about the prospects of being her own boss. But she was also fearful of being completely on her own. Nevertheless, Sheena was determined to make a go of it.

At first, business was a little slow, but once people realized Sheena was available, many asked her to take care of their lawns. Some people were simply glad to turn - the work over to her; others switched from professional lawn care services. By the end of her first year in business, Sheena knew she could earn a living this way. She also performed other services such as fertilizing lawns, weeding gardens, and trimming shrubbery. Business became so good that Sheena hired two part-time workers to assist her and, even then, she believed she could expand further if she wanted to.

#### Questions

1. In what ways are Sheena's customers most likely to judge the quality of her lawn care services?
2. Sheena is the operations manager of her business. Among her responsibilities are forecasting, inventory management, scheduling, quality assurance, and maintenance.

- (a) What kinds of things would likely require forecasts?
  - (b) What inventory items does Sheena probably have? Name one inventory decision she has to make periodically.
  - (c) What scheduling must she do? What things might occur to disrupt schedules and cause Sheena to reschedule?
  - (d) How important is quality assurance to Sheena's business? Explain.
  - (e) What kinds of maintenance must be performed?
3. What are some of the trade-offs that Sheena probably considered relative to:
- (a) Working for a company instead of for herself?
  - (b) Expanding the business?
4. The town is considering an ordinance that would prohibit putting grass clippings at the curb for pickup because local landfills cannot handle the volume. What options might Sheena consider if the ordinance is passed? Name two advantages and two drawbacks of each option.

[Source: *Production/Operations Management* by William J. Stevenson, Irwin/McGraw-Hill]

## WEGMANS FOOD MARKETS

Wegmans Food Markets, Inc., is one of the premier grocery chains in the United States. Headquartered in Rochester, NY, Wegmans operates over 70 stores. The company employs over 23,000 people, and has annual sales of over Rs. 2.0 billion.

Wegmans has a strong reputation for offering its customers high product quality and excellent service. Through a combination of market research, trial and error, and listening to its customers, Wegmans has evolved into a very successful organization. In fact, Wegmans is so good at what it does that grocery chains all over the country send representatives to Wegmans for a firsthand look at operations.

## SUPERSTORES

Many of the company's stores are giant 100,000 square foot superstores, double or triple the size of average supermarkets. A superstore typically employs from 500 to 600 people.

Individual stores differ somewhat in terms of actual size and some special features. Aside from the features normally found in supermarkets, they generally have a large bakery Section (each store bakes its own bread, rolls, cakes, pies, and pastries), and extra large produce sections. They also offer film processing a complete pharmacy, a card shop and video rentals. In-store floral shops range in size up to 800 square feet of space, and offer a wide variety of fresh-cut flowers, flower arrangements, varies and plants. In-store card shops covers over 1000 square feet of floor of floor space. The bulk foods department provides customers with the opportunity to select what quantities they desire from a vast array of foodstuffs and some nonfood items.

Each store is a little different. Among the special features in some stores are a dry cleaning department, a wokery, and a salad bar. Some feature a Market Cafe that has different food stations, each devoted to preparing and serving a certain type of food. For example, one station has pizza and other Italian specialties, and another oriental food. There are also being a sandwich bar, a salad bar and a dessert station. Customers often wander among stations as they decide



what to order. In several affluent locations, customers can stop in on their way home from work and choose from a selection of freshly prepared dinner entrees. Some stores have a coffee shop section with tables and chairs where shoppers can enjoy regular or specialty coffees and variety of tempting pastries.

### **PRODUCE DEPARTMENT**

The company prides itself on fresh produce. Produce is replenished as often as 12 times a day. The larger stores have produce sections that are four to five times the size of a produce section of an average supermarket. Wegmans offers locally grown produce a season. Wegmans uses a 'farm to market' system whereby some local growers deliver their produce directly to individual stores, bypassing the main warehouse. That reduces the company's inventory holding costs and gets the produce into the stores as quickly as possible. Growers may use specially designed containers that go right onto the store floor instead of large bins. This avoids the bruising that often occurs when fruits and vegetables are transferred from bins to display shelves and the need to devote labor to transfer the produce to shelves.

### **MEAT DEPARTMENT**

In addition to large display cases of both fresh and frozen meat products, many stores have a full-service butcher shop that offers a variety of fresh meat products and where butchers are available to provide customized cuts of meat for customers.

### **ORDERING**

Each department handles its own ordering. Although sales records are available from records of items scanned at the checkouts, they are not used directly for replenishing stock. Other factors, such as pricing, special promotions, local circumstances must all be taken into account. However, for seasonal periods, such as holidays, managers often check scanner records to learn what past demand was during a comparable period.

The superstores typically receive one truckload of goods per day from the main warehouse. During peak periods, a store may receive two truckloads from the main warehouse. The short lead-time greatly reduce the length of the time an item might be out of stock, unless the main warehouse is also out of stock.

The company exercises strict control over suppliers, insisting on product quality and on-time deliveries.

### **EMPLOYEES**

The company recognises the value of good employees. It typically invests an average of Rs.7000 to train each new employee. In addition to learning about stores operations, new employees learn the importance of good customer service and how to provide it. The employees are helpful, cheerfully answering customer questions or handling complaints. Employees are motivated through a combination of compensation, profit sharing, and benefits.

### **QUALITY**

Quality and Customer satisfaction are utmost in the minds of Wegmans management and its employees. Private label food items as well as name brands are regularly evaluated in test kitchens, along with the potential new products. Managers are responsible for checking and

maintaining products and service quality in their departments. Moreover, employees are encouraged to report problems to their managers.

If a customer is dissatisfied with an item and returns it, or even a portion of the item, the customer is offered a choice of a replacement or a refund. If the item is a Wegmans brand food item, it is then sent to the test kitchen to determine the cause of the problem. If the cause can be determined, corrective action is taken.

### Questions

1. How do customers judge the quality of a supermarket?
2. Indicate how and why each of these factors is important to the successful operation of a supermarket:
  - (a) Customer satisfaction.
  - (b) Forecasting.
  - (c) Capacity planning.
  - (d) Location
  - (e) Inventory management.
  - (f) Layout of the store.
  - (g) Scheduling.

[Source: *Production/Operations Management* by William J. Stevenson, Irwin/McGraw-Hill]

# 2

## PLANT LOCATION AND LAYOUT

### CHAPTER OUTLINE

2.1 <i>Introduction and Meaning</i>	2.8 <i>Classification of Layout</i>
2.2 <i>Need for Selecting a Suitable Location</i>	2.9 <i>Design of Product Layout</i>
2.3 <i>Factors Influencing Plant/Facility Location</i>	2.10 <i>Design of Process Layout</i>
2.4 <i>Location Theories</i>	2.11 <i>Service Layout</i>
2.5 <i>Location Models</i>	2.12 <i>Organisation of Physical Facilities</i>
2.6 <i>Locational Economics</i>	• <i>Exercises</i>
2.7 <i>Plant Layout</i>	• <i>Skill Development</i>

### 2.1 INTRODUCTION AND MEANING

**Plant location or the facilities location problem** is an important strategic level decision-making for an organisation. One of the key features of a conversion process (manufacturing system) is the efficiency with which the products (services) are transferred to the customers. This fact will include the determination of where to place the plant or facility.

The selection of location is a key-decision as large investment is made in building plant and machinery. It is not advisable or not possible to change the location very often. So an improper location of plant may lead to waste of all the investments made in building and machinery, equipment.

Before a location for a plant is selected, long range forecasts should be made anticipating future needs of the company. The plant location should be based on the company's expansion plan and policy, diversification plan for the products, changing market conditions, the changing sources of raw materials and many other factors that influence the choice of the location decision. The purpose of the location study is to find an optimum location one that will result in the greatest advantage to the organization.

### 2.2 NEED FOR SELECTING A SUITABLE LOCATION

The need for selecting a suitable location arises because of three situations.

- I. When starting a new organisation, *i.e.*, location choice for the first time.
- II. In case of existing organisation.
- III. In case of Global Location.

### I. In Case of Location Choice for the First Time or New Organisations

Cost economies are always important while selecting a location for the first time, but should keep in mind the cost of long-term business/organisational objectives. The following are the factors to be considered while selecting the location for the new organisations:

1. **Identification of region:** The organisational objectives along with the various long-term considerations about marketing, technology, internal organisational strengths and weaknesses, region-specific resources and business environment, legal-governmental environment, social environment and geographical environment suggest a suitable region for locating the operations facility.

2. **Choice of a site within a region:** Once the suitable region is identified, the next step is choosing the best site from an available set. Choice of a site is less dependent on the organisation's long-term strategies. Evaluation of alternative sites for their tangible and intangible costs will resolve facilities-location problem.

The problem of location of a site within the region can be approached with the following cost-oriented non-interactive model, *i.e.*, dimensional analysis.

3. **Dimensional analysis:** If all the costs were tangible and quantifiable, the comparison and selection of a site is easy. The location with the least cost is selected. In most of the cases intangible costs which are expressed in relative terms than in absolute terms. Their relative merits and demerits of sites can also be compared easily. Since both tangible and intangible costs need to be considered for a selection of a site, dimensional analysis is used.

Dimensional analysis consists in computing the relative merits (cost ratio) for each of the cost items for two alternative sites. For each of the ratios an appropriate weightage by means of power is given and multiplying these weighted ratios to come up with a comprehensive figure on the relative merit of two alternative sites, *i.e.*,

$C_1^M, C_2^M, \dots, C_z^M$  are the different costs associated with a site M on the 'z' different cost items.

$C_1^N, C_2^N, \dots, C_z^N$  are the different costs associated with a site N and  $W_1, W_2, W_3, \dots, W_z$  are the weightage given to these cost items, then relative merit of the M and site N is given by:

$$\left(C_1^M / C_1^N\right)^{W_1} \times \left(C_2^M / C_2^N\right)^{W_2} \dots \left(C_z^M / C_z^N\right)^{W_z}$$

If this is  $> 1$ , site N is superior and vice-versa.

When starting a new factory, plant location decisions are very important because they have direct bearing on factors like, financial, employment and distribution patterns. In the long run, relocation of plant may even benefit the organization. But, the relocation of the plant involves stoppage of production, and also cost for shifting the facilities to a new location. In addition to these things, it will introduce some inconvenience in the normal functioning of the business. Hence, at the time of starting any industry, one should generate several alternate sites for locating the plant. After a critical analysis, the best site is to be selected for commissioning the plant. Location of warehouses and other facilities are also having direct bearing on the operational performance of organizations.

The existing firms will seek new locations in order to expand the capacity or to place the existing facilities. When the demand for product increases, it will give rise to following decisions:

- Whether to expand the existing capacity and facilities.
- Whether to look for new locations for additional facilities.
- Whether to close down existing facilities to take advantage of some new locations.

## II. In Case of Location Choice for Existing Organisation

In this case a manufacturing plant has to fit into a multi-plant operations strategy. That is, additional plant location in the same premises and elsewhere under following circumstances:

1. Plant manufacturing distinct products.
2. Manufacturing plant supplying to specific market area.
3. Plant divided on the basis of the process or stages in manufacturing.
4. Plants emphasizing flexibility.

The different operations strategies under the above circumstances could be:

1. **Plants manufacturing distinct products:** Each plant services the entire market area for the organization. This strategy is necessary where the needs of technological and resource inputs are specialized or distinctively different for the different product-lines.

For example, a high quality precision product-line should not be located along with other product-line requiring little emphasis on precision. It may not be proper to have too many contradictions such as sophisticated and old equipment, highly skilled and semi-skilled personnel, delicate processes and those that could permit rough handlings, all under one roof and one set of managers. Such a setting leads to much confusion regarding the required emphasis and the management policies.

Product specialization may be necessary in a highly competitive market. It may be necessary to exploit the special resources of a particular geographical area. The more decentralized these pairs are in terms of the management and in terms of their physical location, the better would be the planning and control and the utilization of the resources.

2. **Manufacturing plants supplying to a specific market area:** Here, each plant manufactures almost all of the company's products. This type of strategy is useful where market proximity consideration dominates the resources and technology considerations. This strategy requires great deal of coordination from the corporate office. An extreme example of this strategy is that of soft drinks bottling plants.

3. **Plants divided on the basis of the process or stages in manufacturing:** Each production process or stage of manufacturing may require distinctively different equipment capabilities, labour skills, technologies, and managerial policies and emphasis. Since the products of one plant feed into the other plant, this strategy requires much centralized coordination of the manufacturing activities from the corporate office that are expected to understand the various technological aspects of all the plants.

4. **Plants emphasizing flexibility:** This requires much coordination between plants to meet the changing needs and at the same time ensure efficient use of the facilities and resources. Frequent changes in the long-term strategy in order to improve be efficiently temporarily, are not healthy for the organization. In any facility location problem the central question is: 'Is this a location at which the company can remain competitive for a long time?'

For an established organization in order to add on to the capacity, following are the ways:

(a) *Expansion of the facilities at the existing site*: This is acceptable when it does not violate the basic business and managerial outlines, *i.e.*, philosophies, purposes, strategies and capabilities. For example, expansion should not compromise quality, delivery, or customer service.

(b) *Relocation of the facilities (closing down the existing ones)*: This is a drastic step which can be called as 'Uprooting and Transplanting'. Unless there are very compelling reasons, relocation is not done. The reasons will be either bringing radical changes in technology, resource availability or other destabilization.

All these factors are applicable to service organizations, whose objectives, priorities and strategies may differ from those of hardcore manufacturing organizations.

### III. In Case of Global Location

Because of globalisation, multinational corporations are setting up their organizations in India and Indian companies are extending their operations in other countries. In case of global locations there is scope for virtual proximity and virtual factory.

#### VIRTUAL PROXIMITY

With the advance in telecommunications technology, a firm can be in virtual proximity to its customers. For a software services firm much of its logistics is through the information/communication pathway. Many firms use the communications highway for conducting a large portion of their business transactions. Logistics is certainly an important factor in deciding on a location—whether in the home country or abroad. Markets have to be reached. Customers have to be contacted. Hence, a market presence in the country of the customers is quite necessary.

#### VIRTUAL FACTORY

Many firms based in USA and UK in the service sector and in the manufacturing sector often out sources part of their business processes to foreign locations such as India. Thus, instead of one's own operations, a firm could use its business associates' operations facilities. The Indian BPO firm is a foreign-based company's 'virtual service factory'. So a location could be one's own or one's business associates. The location decision need not always necessarily pertain to own operations.

### REASONS FOR A GLOBAL/FOREIGN LOCATION

#### A. Tangible Reasons

The tangible reasons for setting up an operations facility abroad could be as follows:

**Reaching the customer:** One obvious reason for locating a facility abroad is that of capturing a share of the market expanding worldwide. The phenomenal growth of the GDP of India is a big reason for the multinationals to have their operations facilities in our country. An important reason is that of providing service to the customer promptly and economically which is logistics-dependent. Therefore, cost and ease of logistics is a reason for setting up manufacturing facilities abroad. By logistics set of activities closes the gap between production of goods/services and reaching of these intended goods/services to the customer to his satisfaction. Reaching the customer is thus the main objective. The tangible and intangible gains and costs depend upon the company defining for itself as to what that 'reaching' means. The tangible costs could be the logistics related costs; the intangible costs may be the risk of operating in a foreign country. The

tangible gains are the immediate gains; the intangible gains are an outcome of what the company defines the concepts of reaching and customer for itself.

The other *tangible reasons* could be as follows:

- (a) The host country may offer substantial tax advantages compared to the home country.
- (b) The costs of manufacturing and running operations may be substantially less in that foreign country. This may be due to lower labour costs, lower raw material cost, better availability of the inputs like materials, energy, water, ores, metals, key personnel etc.
- (c) The company may overcome the tariff barriers by setting up a manufacturing plant in a foreign country rather than exporting the items to that country.

## **B. Intangible Reasons**

The intangible reasons for considering setting up an operations facility abroad could be as follows:

### **1. Customer-related Reasons**

- (a) With an operations facility in the foreign country, the firm's customers may feel secure that the firm is more accessible. Accessibility is an important 'service quality' determinant.
- (b) The firm may be able to give a personal touch.
- (c) The firm may interact more intimately with its customers and may thus understand their requirements better.
- (d) It may also discover other potential customers in the foreign location.

### **2. Organisational Learning-related Reasons**

- (a) The firm can learn advanced technology. For example, it is possible that cutting-edge technologies can be learned by having operations in a technologically more advanced country. The firm can learn from advanced research laboratories/universities in that country. Such learning may help the entire product-line of the company.
- (b) The firm can learn from its customers abroad. A physical location there may be essential towards this goal.
- (c) It can also learn from its competitors operating in that country. For this reason, it may have to be physically present where the action is.
- (d) The firm may also learn from its suppliers abroad. If the firm has a manufacturing plant there, it will have intensive interaction with the suppliers in that country from whom there may be much to learn in terms of modern and appropriate technology, modern management methods, and new trends in business worldwide.

### **3. Other Strategic Reasons**

- (a) The firm by being physically present in the host country may gain some 'local boy' kind of psychological advantage. The firm is no more a 'foreign' company just sending its products across international borders. This may help the firm in lobbying with the government of that country and with the business associations in that country.
- (b) The firm may avoid 'political risk' by having operations in multiple countries.
- (c) By being in the foreign country, the firm can build alternative sources of supply. The firm could, thus, reduce its supply risks.

- (d) The firm could hunt for human capital in different countries by having operations in those countries. Thus, the firm can gather the best of people from across the globe.
- (e) Foreign locations in addition to the domestic locations would lower the market risks for the firm. If one market goes slow the other may be doing well, thus lowering the overall risk.

## 2.3 FACTORS INFLUENCING PLANT LOCATION/FACILITY LOCATION

Facility location is the process of determining a geographic site for a firm's operations. Managers of both service and manufacturing organizations must weigh many factors when assessing the desirability of a particular site, including proximity to customers and suppliers, labour costs, and transportation costs.

Location conditions are complex and each comprises a different Characteristic of a tangible (i.e. Freight rates, production costs) and non-tangible (i.e. reliability, Frequency security, quality) nature.

Location conditions are hard to measure. Tangible cost based factors such as wages and products costs can be quantified precisely into what makes locations better to compare. On the other hand non-tangible features, which refer to such characteristics as reliability, availability and security, can only be measured along an ordinal or even nominal scale. Other non-tangible features like the percentage of employees that are unionized can be measured as well. To sum this up non-tangible features are very important for business location decisions.

It is appropriate to divide the factors, which influence the plant location or facility location on the basis of the nature of the organisation as

1. **General locational factors**, which include controllable and uncontrollable factors for all type of organisations.
2. **Specific locational factors** specifically required for manufacturing and service organisations.

Location factors can be further divided into two categories:

Dominant factors are those derived from competitive priorities (cost, quality, time, and flexibility) and have a particularly strong impact on sales or costs. Secondary factors also are important, but management may downplay or even ignore some of them if other factors are more important.

### 2.3.1 General Locational Factors

Following are the general factors required for location of plant in case of all types of organisations.

#### CONTROLLABLE FACTORS

1. Proximity to markets
2. Supply of materials
3. Transportation facilities
4. Infrastructure availability
5. Labour and wages



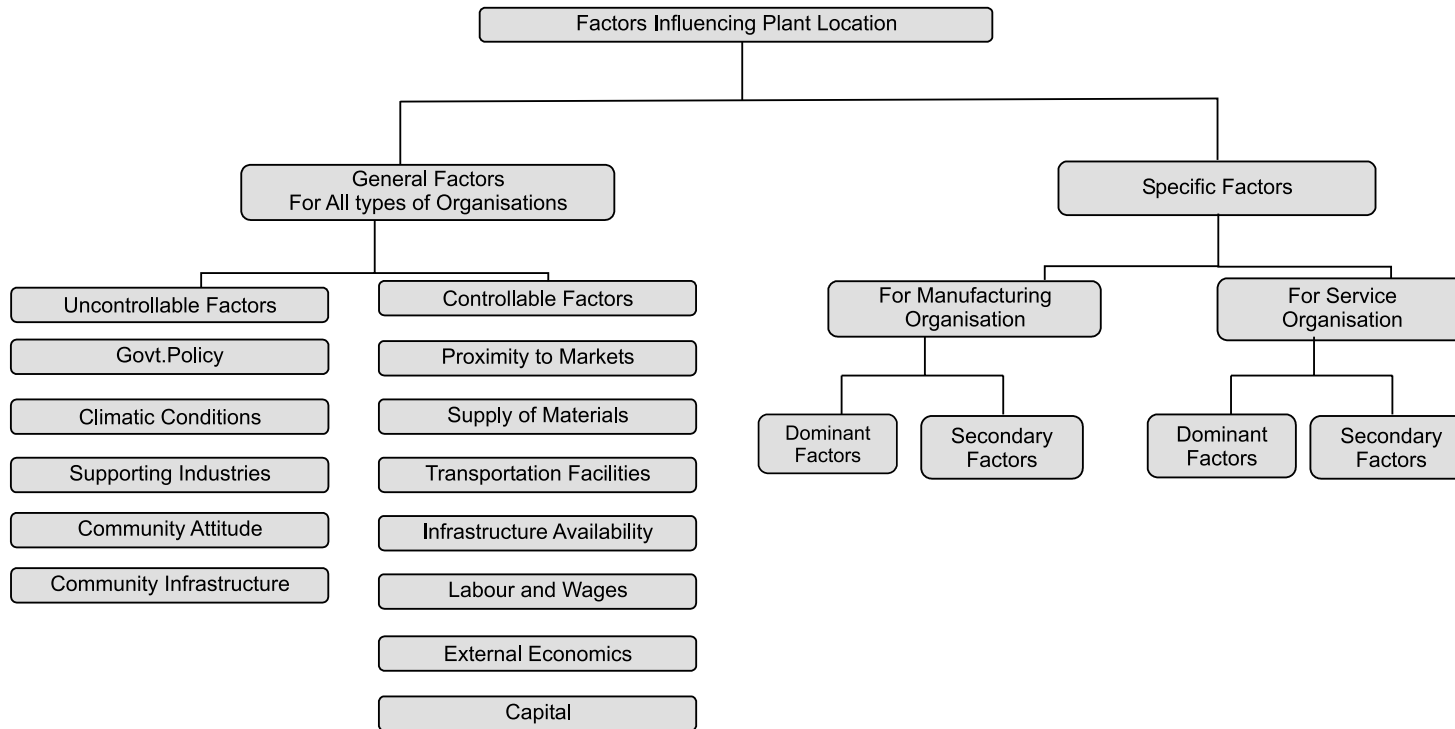

**Fig. 2.1** *Factors influencing plant location.*

6. External economies
7. Capital

#### UNCONTROLLABLE FACTORS

8. Government policy
9. Climate conditions
10. Supporting industries and services
11. Community and labour attitudes
12. Community Infrastructure

#### CONTROLLABLE FACTORS

**1. Proximity to markets:** Every company is expected to serve its customers by providing goods and services at the time needed and at reasonable price organizations may choose to locate facilities close to the market or away from the market depending upon the product. When the buyers for the product are concentrated, it is advisable to locate the facilities close to the market.

Locating nearer to the market is preferred if

- The products are delicate and susceptible to spoilage.
- After sales services are promptly required very often.
- Transportation cost is high and increase the cost significantly.
- Shelf life of the product is low.

Nearness to the market ensures a consistent supply of goods to customers and reduces the cost of transportation.

**2. Supply of raw material:** It is essential for the organization to get raw material in right qualities and time in order to have an uninterrupted production. This factor becomes very important if the materials are perishable and cost of transportation is very high.

General guidelines suggested by Yaseen regarding effects of raw materials on plant location are:

- When a single raw material is used without loss of weight, locate the plant at the raw material source, at the market or at any point in between.
- When weight losing raw material is demanded, locate the plant at the raw material source.
- When raw material is universally available, locate close to the market area.
- If the raw materials are processed from variety of locations, the plant may be situated so as to minimize total transportation costs.

Nearness to raw material is important in case of industries such as sugar, cement, jute and cotton textiles.

**3. Transportation facilities:** Speedy transport facilities ensure timely supply of raw materials to the company and finished goods to the customers. The transport facility is a prerequisite for

the location of the plant. There are five basic modes of physical transportation, air, road, rail, water and pipeline. Goods that are mainly intended for exports demand a location near to the port or large airport. The choice of transport method and hence the location will depend on relative costs, convenience, and suitability. Thus transportation cost to value added is one of the criteria for plant location.

**4. Infrastructure availability:** The basic infrastructure facilities like power, water and waste disposal, etc., become the prominent factors in deciding the location. Certain types of industries are power hungry e.g., aluminum and steel and they should be located close to the power station or location where uninterrupted power supply is assured throughout the year. The non-availability of power may become a survival problem for such industries. Process industries like paper, chemical, cement, etc., require continuous. Supply of water in large amount and good quality, and mineral content of water becomes an important factor. A waste disposal facility for process industries is an important factor, which influences the plant location.

**5. Labour and wages:** The problem of securing adequate number of labour and with skills specific is a factor to be considered both at territorial as well as at community level during plant location. Importing labour is usually costly and involve administrative problem. The history of labour relations in a prospective community is to be studied. Prospective community is to be studied. Productivity of labour is also an important factor to be considered. Prevailing wage pattern, cost of living and industrial relation and bargaining power of the unions' forms in important considerations.

**6. External economies of scale:** External economies of scale can be described as urbanization and locational economies of scale. It refers to advantages of a company by setting up operations in a large city while the second one refers to the "settling down" among other companies of related Industries. In the case of urbanization economies, firms derive from locating in larger cities rather than in smaller ones in a search of having access to a large pool of labour, transport facilities, and as well to increase their markets for selling their products and have access to a much wider range of business services.

Location economies of scale in the manufacturing sector have evolved over time and have mainly increased competition due to production facilities and lower production costs as a result of lower transportation and logistical costs. This led to manufacturing districts where many companies of related industries are located more or less in the same area. As large corporations have realized that inventories and warehouses have become a major cost factor, they have tried reducing inventory costs by launching "Just in Time" production system (the so called Kanban System). This high efficient production system was one main factor in the Japanese car industry for being so successful. Just in time ensures to get spare parts from suppliers within just a few hours after ordering. To fulfill these criteria corporations have to be located in the same area increasing their market and service for large corporations.

**7. Capital:** By looking at capital as a location condition, it is important to distinguish the physiology of fixed capital in buildings and equipment from financial capital. Fixed capital costs as building and construction costs vary from region to region. But on the other hand buildings can also be rented and existing plants can be expanded. Financial capital is highly mobile and does not very much influence decisions. For example, large Multinational Corporations such as Coca-

Cola operate in many different countries and can raise capital where interest rates are lowest and conditions are most suitable.

Capital becomes a main factor when it comes to venture capital. In that case young, fast growing (or not) high tech firms are concerned which usually have not many fixed assets. These firms particularly need access to financial capital and also skilled educated employees.

#### **UNCONTROLLABLE FACTORS**

**8. Government policy:** The policies of the state governments and local bodies concerning labour laws, building codes, safety, etc., are the factors that demand attention.

In order to have a balanced regional growth of industries, both central and state governments in our country offer the package of incentives to entrepreneurs in particular locations. The incentive package may be in the form of exemption from a sales tax and excise duties for a specific period, soft loan from financial institutions, subsidy in electricity charges and investment subsidy. Some of these incentives may tempt to locate the plant to avail these facilities offered.

**9. Climatic conditions:** The geology of the area needs to be considered together with climatic conditions (humidity, temperature). Climates greatly influence human efficiency and behaviour. Some industries require specific climatic conditions e.g., textile mill will require humidity.

**10. Supporting industries and services:** Now a day the manufacturing organisation will not make all the components and parts by itself and it subcontracts the work to vendors. So, the source of supply of component parts will be the one of the factors that influences the location.

The various services like communications, banking services professional consultancy services and other civil amenities services will play a vital role in selection of a location.

**11. Community and labour attitudes:** Community attitude towards their work and towards the prospective industries can make or mar the industry. Community attitudes towards supporting trade union activities are important criteria. Facility location in specific location is not desirable even though all factors are favouring because of labour attitude towards management, which brings very often the strikes and lockouts.

**12. Community infrastructure and amenity:** All manufacturing activities require access to a community infrastructure, most notably economic overhead capital, such as roads, railways, port facilities, power lines and service facilities and social overhead capital like schools, universities and hospitals.

These factors are also needed to be considered by location decisions as infrastructure is enormously expensive to build and for most manufacturing activities the existing stock of infrastructure provides physical restrictions on location possibilities.

### **2.3.2 Specific Locational Factors for Manufacturing Organisation**

#### **DOMINANT FACTORS**

Factors dominating location decisions for new manufacturing plants can be broadly classified in six groups. They are listed in the order of their importance as follows.

1. Favourable labour climate
2. Proximity to markets
3. Quality of life
4. Proximity to suppliers and resources
5. Utilities, taxes, and real estate costs

**1. Favorable labour climate:** A favorable labour climate may be the most important factor in location decisions for labour-intensive firms in industries such as textiles, furniture, and consumer electronics. Labour climate includes wage rates, training requirements, attitudes toward work, worker productivity, and union strength. Many executives consider weak unions or a low probability of union organizing efforts as a distinct advantage.

**2. Proximity to markets:** After determining where the demand for goods and services is greatest, management must select a location for the facility that will supply that demand. Locating near markets is particularly important when the final goods are bulky or heavy and outbound transportation rates are high. For example, manufacturers of products such as plastic pipe and heavy metals all emphasize proximity to their markets.

**3. Quality of life:** Good schools, recreational facilities, cultural events, and an attractive lifestyle contribute to quality of life. This factor is relatively unimportant on its own, but it can make the difference in location decisions.

**4. Proximity to suppliers and resources:** In many companies, plants supply parts to other facilities or rely on other facilities for management and staff support. These require frequent coordination and communication, which can become more difficult as distance increases.

**5. Utilities, taxes, and real estate costs:** Other important factors that may emerge include utility costs (telephone, energy, and water), local and state taxes, financing incentives offered by local or state governments, relocation costs, and land costs.

### SECONDARY FACTORS

There are some other factors needed to be considered, including room for expansion, construction costs, accessibility to multiple modes of transportation, the cost of shuffling people and materials between plants, competition from other firms for the workforce, community attitudes, and many others. For global operations, firms are emphasizing local employee skills and education and the local infrastructure.

### 2.3.3 Specific Locational Factors for Service Organisation

#### DOMINANT FACTORS

The factors considered for manufacturers are also applied to service providers, with one important addition — the impact of location on sales and customer satisfaction. Customers usually look about how close a service facility is, particularly if the process requires considerable customer contact.

**PROXIMITY TO CUSTOMERS**

Location is a key factor in determining how conveniently customers can carry on business with a firm. For example, few people would like to go to remotely located dry cleaner or supermarket if another is more convenient. Thus the influence of location on revenues tends to be the dominant factor.

**TRANSPORTATION COSTS AND PROXIMITY TO MARKETS**

For warehousing and distribution operations, transportation costs and proximity to markets are extremely important. With a warehouse nearby, many firms can hold inventory closer to the customer, thus reducing delivery time and promoting sales.

**LOCATION OF COMPETITORS**

One complication in estimating the sales potential at different location is the impact of competitors. Management must not only consider the current location of competitors but also try to anticipate their reaction to the firm's new location. Avoiding areas where competitors are already well established often pays. However, in some industries, such as new-car sales showrooms and fast-food chains, locating near competitors is actually advantageous. The strategy is to create a critical mass, whereby several competing firms clustered in one location attract more customers than the total number who would shop at the same stores at scattered locations. Recognizing this effect, some firms use a follow –the leader strategy when selecting new sites.

**SECONDARY FACTORS**

Retailers also must consider the level of retail activity, residential density, traffic flow, and site visibility. Retail activity in the area is important, as shoppers often decide on impulse to go shopping or to eat in a restaurant. Traffic flows and visibility are important because businesses' customers arrive in cars. Visibility involves distance from the street and size of nearby buildings and signs. High residential density ensures nighttime and weekend business when the population in the area fits the firm's competitive priorities and target market segment.

**2.4****LOCATION THEORIES****ALFRED WEBER'S THEORY OF THE LOCATION OF INDUSTRIES**

Alfred Weber (1868–1958), with the publication of *Theory of the Location of Industries* in 1909, put forth the first developed general theory of industrial location. His model took into account several spatial factors for finding the optimal location and minimal cost for manufacturing plants.

The point for locating an industry that minimizes costs of transportation and labour requires analysis of three factors:

1. The point of optimal transportation based on the costs of distance to the 'material index'—the ratio of weight to intermediate products (raw materials) to finished product.
2. The labour distortion, in which more favourable sources of lower cost of labour may justify greater transport distances.
3. Agglomeration and degglomeration.

**Agglomeration or concentration** of firms in a locale occurs when there is sufficient demand for support services for the company and labour force, including new investments in schools and hospitals. Also supporting companies, such as facilities that build and service machines and financial services, prefer closer contact with their customers.

**Degglomeration** occurs when companies and services leave because of over concentration of industries or of the wrong types of industries, or shortages of labour, capital, affordable land, etc. Weber also examined factors leading to the diversification of an industry in the horizontal relations between processes within the plant.

The issue of industry location is increasingly relevant to today's global markets and transnational corporations. Focusing only on the mechanics of the Weberian model could justify greater transport distances for cheap labour and unexploited raw materials. When resources are exhausted or workers revolt, industries move to different countries.

## 2.5 LOCATION MODELS

Various models are available which help to identify the ideal location. Some of the popular models are:

1. Factor rating method
2. Weighted factor rating method
3. Load-distance method
4. Centre of gravity method
5. Break even analysis

### 2.5.1 Factor Rating Method

The process of selecting a new facility location involves a series of following steps:

1. Identify the important location factors.
2. Rate each factor according to its relative importance, *i.e.*, higher the ratings is indicative of prominent factor.
3. Assign each location according to the merits of the location for each factor.
4. Calculate the rating for each location by multiplying factor assigned to each location with basic factors considered.
5. Find the sum of product calculated for each factor and select best location having highest total score.

**ILLUSTRATION 1:** *Let us assume that a new medical facility, Health-care, is to be located in Delhi. The location factors, factor rating and scores for two potential sites are shown in the following table. Which is the best location based on factor rating method?*

Sl. No.	Location factor	Factor rating	Rating	
			Location 1	Location 2
1.	Facility utilization	8	3	5
2.	Total patient per month	5	4	3
3.	Average time per emergency trip	6	4	5
4.	Land and construction costs	3	1	2
5.	Employee preferences	5	5	3

**SOLUTION:**

Sl. No.	Location factor	Factor rating (1)	Location 1		Location 2	
			(Rating) (2)	Total= (1) . (2)	(Rating) (3)	Total = (1) . (3)
1.	Facility utilization	8	3	24	5	40
2.	Total patient per month	5	4	20	3	15
3.	Average time per emergency trip	6	4	24	5	30
4.	Land and construction costs	3	1	3	2	6
5.	Employee preferences	5	5	25	3	15
			Total	96	Total	106

The total score for location 2 is higher than that of location 1. Hence location 2, is the best choice.

**2.5.2 Weighted Factor Rating Method**

In this method to merge quantitative and qualitative factors, factors are assigned weights based on relative importance and weightage score for each site using a preference matrix is calculated. The site with the highest weighted score is selected as the best choice.

**ILLUSTRATION 2:** Let us assume that a new medical facility, Health-care, is to be located in Delhi. The location factors, weights, and scores (1 = poor, 5 = excellent) for two potential sites are shown in the following table. What is the weighted score for these sites? Which is the best location?

Sl. No.	Location factor	Weight	Scores	
			Location 1	Location 2
1.	Facility utilization	25	3	5
2.	Total patient km per month	25	4	3
3.	Average time per emergency trip	25	3	3
4.	Land and construction costs	15	1	2
5.	Employee preferences	10	5	3



**SOLUTION:** The weighted score for this particular site is calculated by multiplying each factor's weight by its score and adding the results:

$$\begin{aligned}\text{Weighed score location 1} &= 25 \times 3 + 25 \times 4 + 25 \times 3 + 15 \times 1 + 10 \times 5 \\ &= 75 + 100 + 75 + 15 + 50 = 315\end{aligned}$$

$$\begin{aligned}\text{Weighed score location 2} &= 25 \times 5 + 25 \times 3 + 25 \times 3 + 15 \times 2 + 10 \times 3 \\ &= 125 + 75 + 75 + 30 + 30 = 335\end{aligned}$$

Location 2 is the best site based on total weighted scores.

### 2.5.3 Load-distance Method

The load-distance method is a mathematical model used to evaluate locations based on proximity factors. The objective is to select a location that minimizes the total weighted loads moving into and out of the facility. The distance between two points is expressed by assigning the points to grid coordinates on a map. An alternative approach is to use time rather than distance.

#### DISTANCE MEASURES

Suppose that a new warehouse is to be located to serve Delhi. It will receive inbound shipments from several suppliers, including one in Ghaziabad. If the new warehouse were located at Gurgaon, what would be the distance between the two facilities? If shipments travel by truck, the distance depends on the highway system and the specific route taken. Computer software is available for calculating the actual mileage between any two locations in the same county. However, for load-distance method, a rough calculation that is either Euclidean or rectilinear distance measure may be used. Euclidean distance is the straight-line distance, or shortest possible path, between two points.

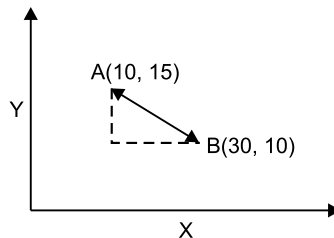

**Fig. 2.2** Distance between point A and point B

The point A on the grid represents the supplier's location in Ghaziabad, and the point B represents the possible warehouse location at Gurgaon. The distance between points A and B is the length of the hypotenuse of a right triangle, or

$$d_{AB} = \text{Sqrt} ((X_A - X_B)^2 + (Y_A - Y_B)^2)$$

where  $d_{AB}$  = distance between points A and B

$X_A$  = x-coordinate of point A

$Y_A$  = y-coordinate of point A

$X_B$  = x-coordinate of point B

$Y_B$  = y-coordinate of point B

Rectilinear distance measures distance between two points with a series of 90° turns as city blocks. Essentially, this distance is the sum of the two dashed lines representing the base and side of the triangle in figure. The distance travelled in the  $x$ -direction is the absolute value of the difference in  $x$ -coordinates. Adding this result to the absolute value of the difference in the  $y$ -coordinates gives

$$D_{AB} = |X_A - X_B| + |Y_A - Y_B|$$

### CALCULATING A LOAD-DISTANCE SCORE

Suppose that a firm planning a new location wants to select a site that minimizes the distances that loads, particularly the larger ones, must travel to and from the site. Depending on the industry, a load may be shipments from suppliers, between plants, or to customers, or it may be customers or employees travelling to or from the facility. The firm seeks to minimize its load-distance, generally by choosing a location so that large loads go short distances.

To calculate a load-distance for any potential location, we use either of the distance measures and simply multiply the loads flowing to and from the facility by the distances travelled. These loads may be expressed as tones or number of trips per week.

This calls for a practical example to appreciate the relevance of the concept. Let us visit a new Health-care facility, once again.

**ILLUSTRATION 3:** *The new Health-care facility is targeted to serve seven census tracts in Delhi. The table given below shows the coordinates for the centre of each census tract, along with the projected populations, measured in thousands. Customers will travel from the seven census tract centres to the new facility when they need health-care. Two locations being considered for the new facility are at (5.5, 4.5) and (7, 2), which are the centres of census tracts C and F. Details of seven census tract centres, co-ordinate distances along with the population for each centre are given below. If we use the population as the loads and use rectilinear distance, which location is better in terms of its total load-distance score?*

Sl. No.	Census tract	(x, y)	Population (l)
1	A	(2.5, 4.5)	2
2	B	(2.5, 2.5)	5
3	C	(5.5, 4.5)	10
4	D	(5, 2)	7
5	E	(8, 5)	10
6	F	(7, 2)	20
7	G	(9, 2.5)	14

**SOLUTION:** Calculate the load-distance score for each location. Using the coordinates from the above table. Calculate the load-distance score for each tract.

Using the formula  $D_{AB} = |X_A - X_B| + |Y_A - Y_B|$

Census tract	(x, y)	Population (l)	Locate at (5.5, 4.5)		Locate at (7, 2)	
			Distance (d)	Load-distance	Distance (d)	Load-distance
A	(2.5, 4.5)	2	3 + 0 = 3	6	4.5 + 2.5 = 7	14
B	(2.5, 2.5)	5	3 + 2 = 5	25	4.5 + 0.5 = 5	25
C	(5.5, 4.5)	10	0 + 0 = 0	0	1.5 + 2.5 = 4	40
D	(5, 2)	7	0.5 + 2.5 = 3	21	2 + 0 = 2	14
E	(8, 5)	10	2.5 + 0.5 = 3	30	1 + 3 = 4	40
F	(7, 2)	20	1.5 + 2.5 = 4	80	0 + 0 = 0	0
G	(9, 2.5)	14	3.5 + 2 = 5.5	77	2 + 0.5 = 2.5	35
			Total	239	Total	168

Summing the scores for all tracts gives a total load-distance score of 239 when the facility is located at (5.5, 4.5) versus a load-distance score of 168 at location (7, 2). Therefore, the location in census tract F is a better location.

#### 2.5.4 Centre of Gravity

Centre of gravity is based primarily on cost considerations. This method can be used to assist managers in balancing cost and service objectives. The centre of gravity method takes into account the locations of plants and markets, the volume of goods moved, and transportation costs in arriving at the best location for a single intermediate warehouse.

The centre of gravity is defined to be the location that minimizes the weighted distance between the warehouse and its supply and distribution points, where the distance is weighted by the number of tones supplied or consumed. The first step in this procedure is to place the locations on a coordinate system. The origin of the coordinate system and scale used are arbitrary, just as long as the relative distances are correctly represented. This can be easily done by placing a grid over an ordinary map. The centre of gravity is determined by the formula.

$$C_x = \frac{\sum D_{ix} \cdot W_i}{\sum W_i} \quad C_y = \frac{\sum D_{iy} \cdot W_i}{\sum W_i}$$

where  $C_x$  = x-coordinate of the centre of gravity  
 $C_y$  = y-coordinate of the centre of gravity  
 $D_{ix}$  = x-coordinate of location  $i$   
 $D_{iy}$  = y-coordinate of location  $i$

**ILLUSTRATION 4:** The new Health-care facility is targeted to serve seven census tracts in Delhi. The table given below shows the coordinates for the centre of each census tract, along with the projected populations, measured in thousands. Customers will travel from the seven census tract centres to the new facility when they need health-care. Two locations being considered for the new facility are at (5.5, 4.5) and (7, 2), which are the centres of census tracts C and F. Details of seven census tract centres, coordinate distances along with the population for each centre are given below. Find the target area's centre of gravity for the Health-care medical facility.

<i>Sl. No.</i>	<i>Census tract</i>	<i>(x, y)</i>	<i>Population (l)</i>
1	A	(2.5, 4.5)	2
2	B	(2.5, 2.5)	5
3	C	(5.5, 4.5)	10
4	D	(5, 2)	7
5	E	(8, 5)	10
6	F	(7, 2)	20
7	G	(9, 2.5)	14

**SOLUTION:** To calculate the centre of gravity, start with the following information, where population is given in thousands.

<i>Sl. No.</i>	<i>Census tract</i>	<i>(x, y)</i>	<i>Population (l)</i>	<i>Lx</i>	<i>Ly</i>
1	A	(2.5, 4.5)	2	5	9
2	B	(2.5, 2.5)	5	12.5	12.5
3	C	(5.5, 4.5)	10	55	45
4	D	(5, 2)	7	35	14
5	E	(8, 5)	10	80	50
6	F	(7, 2)	20	140	40
7	G	(9, 2.5)	14	126	35
		Total	68	453.50	205.50

Next we find  $C_x$  and  $C_y$ .

$$C_x = 453.5/68 = 6.67$$

$$C_y = 205.5/68 = 3.02$$

The centre of gravity is (6.67, 3.02). Using the centre of gravity as starting point, managers can now search in its vicinity for the optimal location.

### 2.5.5 Break Even Analysis

Break even analysis implies that at some point in the operations, total revenue equals total cost. Break even analysis is concerned with finding the point at which revenues and costs agree exactly. It is called 'Break-even Point'. The Fig. 2.3 portrays the Break Even Chart:

Break even point is the volume of output at which neither a profit is made nor a loss is incurred. The Break Even Point (BEP) in units can be calculated by using the relation:

$$BEP = \frac{\text{Fixed Cost}}{\text{Contribution per unit}} = \frac{\text{Fixed Cost}}{\text{Selling Price} - \text{Variable Cost per unit}} = \frac{F}{S - V} \text{ units}$$

The Break Even Point (BEP) in Rs. can be calculated by using the relation:

$$BEP = \frac{\text{Fixed Cost}}{\text{PV Ratio}} = \frac{\text{Fixed Cost}}{\left\{ \frac{\text{Sales} - \text{Variable Cost}}{\text{Sales}} \right\}} = \frac{F}{\phi} \text{ Rs.}$$

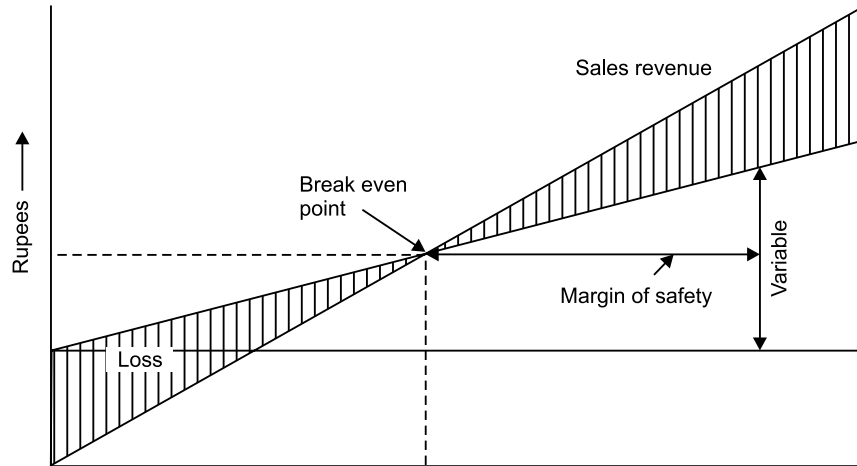

**Fig. 2.3** Units of output or percentage of capacity

Plotting the break even chart for each location can make economic comparisons of locations. This will be helpful in identifying the range of production volume over which location can be selected.

**ILLUSTRATION 5:** Potential locations X, Y and Z have the cost structures shown below. The ABC company has a demand of 1,30,000 units of a new product. Three potential locations X, Y and Z having following cost structures shown are available. Select which location is to be selected and also identify the volume ranges where each location is suited?

	Location X	Location Y	Location Z
Fixed Costs	Rs. 150,000	Rs. 350,000	Rs. 950,000
Variable Costs	Rs. 10	Rs. 8	Rs. 6

**SOLUTION:** Solve for the crossover between X and Y:

$$10X + 150,000 = 8X + 350,000$$

$$2X = 200,000$$

$$X = 100,000 \text{ units}$$

Solve for the crossover between Y and Z:

$$8X + 350,000 = 6X + 950,000$$

$$2X = 600,000$$

$$X = 300,000 \text{ units}$$

Therefore, at a volume of 1,30,000 units, Y is the appropriate strategy.

From the graph (Fig. 2.4) we can interpret that location X is suitable up to 100,000 units, location Y is suitable up to between 100,000 to 300,000 units and location Z is suitable if the demand is more than 300,000 units.

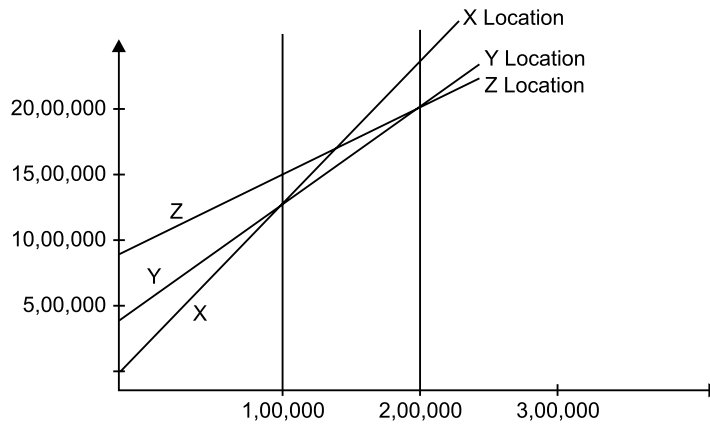

Fig. 2.4 BEP chart

**2.6** LOCALATIONAL ECONOMICS

An ideal location is one which results in lowest production cost and least distribution cost per unit. These costs are influenced by a number of factors as discussed earlier. The various costs which decide locational economy are those of land, building, equipment, labour, material, etc. Other factors like community attitude, community facilities and housing facilities will also influence the selection of best location. Economic analysis is carried out to decide as to which locate best location.

The following illustration will clarify the method of evaluation of best layout selection.

**ILLUSTRATION 6:** From the following data select the most advantageous location for setting a plant for making transistor radios.

	Site X Rs.	Site Y Rs.	Site Z Rs.
(i) Total initial investment	2,00,000	2,00,000	2,00,000
(ii) Total expected sales	2,50,000	3,00,000	2,50,000
(iii) Distribution expenses	40,000	40,000	75,000
(iv) Raw material expenses	70,000	80,000	90,000
(v) Power and water supply expenses	40,000	30,000	20,000
(vi) Wages and salaries	20,000	25,000	20,000
(vii) Other expenses	25,000	40,000	30,000
(viii) Community attitude	Indifferent	Want business	Indifferent
(ix) Employee housing facilities	Poor	Excellent	Good

**SOLUTION:**

	Site X Rs.	Site Y Rs.	Site Z Rs.
Total expenses			
[Add (iii) (iv) (v) (vi) and (vii)]	1,95,000	2,15,000	2,35,000

$$\begin{aligned} \text{Rate of return (RoR), \%} &= \frac{\text{Total sales} - \text{Total expenses}}{\text{Total investment}} \times 100 \\ \text{RoR for Site X} &= \frac{2,50,000 - 1,95,000}{2,00,000} \times 100 \\ &= 27.5\% \\ \text{RoR for Site Y} &= \frac{3,00,000 - 2,15,000}{2,00,000} \times 100 \\ &= 42.5\% \\ \text{RoR for Site Z} &= \frac{2,50,000 - 2,35,000}{2,00,000} \times 100 \\ &= 7.5\% \end{aligned}$$

Location Y can be selected because of higher rate of return.

## 2.7 PLANT LAYOUT

Plant layout refers to the physical arrangement of production facilities. It is the configuration of departments, work centres and equipment in the conversion process. It is a floor plan of the physical facilities, which are used in production.

According to Moore “*Plant layout is a plan of an optimum arrangement of facilities including personnel, operating equipment, storage space, material handling equipment and all other supporting services along with the design of best structure to contain all these facilities*”.

### 2.7.1 Objectives of Plant Layout

The primary goal of the plant layout is to maximise the profit by arrangement of all the plant facilities to the best advantage of total manufacturing of the product.

The objectives of plant layout are:

1. Streamline the flow of materials through the plant.
2. Facilitate the manufacturing process.
3. Maintain high turnover of in-process inventory.
4. Minimise materials handling and cost.
5. Effective utilisation of men, equipment and space.
6. Make effective utilisation of cubic space.
7. Flexibility of manufacturing operations and arrangements.
8. Provide for employee convenience, safety and comfort.
9. Minimize investment in equipment.
10. Minimize overall production time.
11. Maintain flexibility of arrangement and operation.
12. Facilitate the organizational structure.

### 2.7.2 Principles of Plant Layout

1. **Principle of integration:** A good layout is one that integrates men, materials, machines and supporting services and others in order to get the optimum utilisation of resources and maximum effectiveness.

2. **Principle of minimum distance:** This principle is concerned with the minimum travel (or movement) of man and materials. The facilities should be arranged such that, the total distance travelled by the men and materials should be minimum and as far as possible straight line movement should be preferred.

3. **Principle of cubic space utilisation:** The good layout is one that utilise both horizontal and vertical space. It is not only enough if only the floor space is utilised optimally but the third dimension, *i.e.*, the height is also to be utilised effectively.

4. **Principle of flow:** A good layout is one that makes the materials to move in forward direction towards the completion stage, *i.e.*, there should not be any backtracking.

5. **Principle of maximum flexibility:** The good layout is one that can be altered without much cost and time, *i.e.*, future requirements should be taken into account while designing the present layout.

6. **Principle of safety, security and satisfaction:** A good layout is one that gives due consideration to workers safety and satisfaction and safeguards the plant and machinery against fire, theft, etc.

7. **Principle of minimum handling:** A good layout is one that reduces the material handling to the minimum.

## 2.8 CLASSIFICATION OF LAYOUT

Layouts can be classified into the following five categories:

1. Process layout
2. Product layout
3. Combination layout
4. Fixed position layout
5. Group layout

### 2.8.1 Process Layout

Process layout is recommended for batch production. All machines performing similar type of operations are grouped at one location in the process layout *e.g.*, all lathes, milling machines, etc. are grouped in the shop will be clustered in like groups.

Thus, in process layout the arrangement of facilities are grouped together according to their functions. A typical process layout is shown in Fig. 2.5. The flow paths of material through the facilities from one functional area to another vary from product to product. Usually the paths are long and there will be possibility of backtracking.

Process layout is normally used when the production volume is not sufficient to justify a product layout. Typically, job shops employ process layouts due to the variety of products manufactured and their low production volumes.



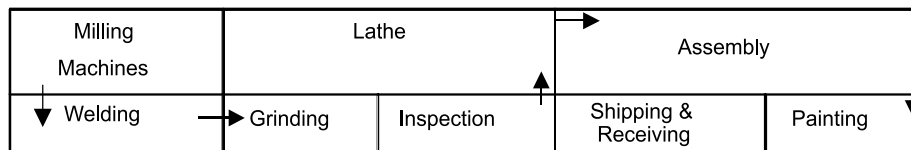

**Fig. 2.5** Process layout

### Advantages

1. In process layout machines are better utilized and fewer machines are required.
2. Flexibility of equipment and personnel is possible in process layout.
3. Lower investment on account of comparatively less number of machines and lower cost of general purpose machines.
4. Higher utilisation of production facilities.
5. A high degree of flexibility with regards to work distribution to machineries and workers.
6. The diversity of tasks and variety of job makes the job challenging and interesting.
7. Supervisors will become highly knowledgeable about the functions under their department.

### Limitations

1. Backtracking and long movements may occur in the handling of materials thus, reducing material handling efficiency.
2. Material handling cannot be mechanised which adds to cost.
3. Process time is prolonged which reduce the inventory turnover and increases the in-process inventory.
4. Lowered productivity due to number of set-ups.
5. Throughput (time gap between in and out in the process) time is longer.
6. Space and capital are tied up by work-in-process.

### 2.8.2 Product Layout

In this type of layout, machines and auxiliary services are located according to the processing sequence of the product. If the volume of production of one or more products is large, the facilities can be arranged to achieve efficient flow of materials and lower cost per unit. Special purpose machines are used which perform the required function quickly and reliably.

The product layout is selected when the volume of production of a product is high such that a separate production line to manufacture it can be justified. In a strict product layout, machines are not shared by different products. Therefore, the production volume must be sufficient to achieve satisfactory utilisation of the equipment. A typical product layout is shown in Fig. 2.6.

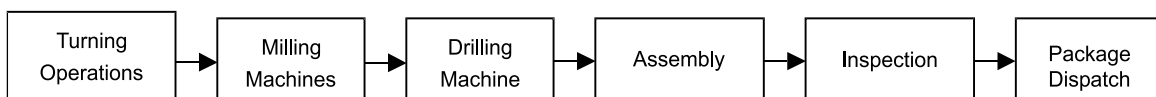

**Fig. 2.6** Product layout

### Advantages

1. The flow of product will be smooth and logical in flow lines.
2. In-process inventory is less.
3. Throughput time is less.
4. Minimum material handling cost.
5. Simplified production, planning and control systems are possible.
6. Less space is occupied by work transit and for temporary storage.
7. Reduced material handling cost due to mechanised handling systems and straight flow.
8. Perfect line balancing which eliminates bottlenecks and idle capacity.
9. Manufacturing cycle is short due to uninterrupted flow of materials.
10. Small amount of work-in-process inventory.
11. Unskilled workers can learn and manage the production.

### Limitations

1. A breakdown of one machine in a product line may cause stoppages of machines in the downstream of the line.
2. A change in product design may require major alterations in the layout.
3. The line output is decided by the bottleneck machine.
4. Comparatively high investment in equipments is required.
5. *Lack of flexibility.* A change in product may require the facility modification.

### 2.8.3 Combination Layout

A combination of process and product layouts combines the advantages of both types of layouts. A combination layout is possible where an item is being made in different types and sizes. Here machinery is arranged in a process layout but the process grouping is then arranged in a sequence to manufacture various types and sizes of products. It is to be noted that the sequence of operations remains same with the variety of products and sizes. Figure 2.7 shows a combination type of layout for manufacturing different sized gears.

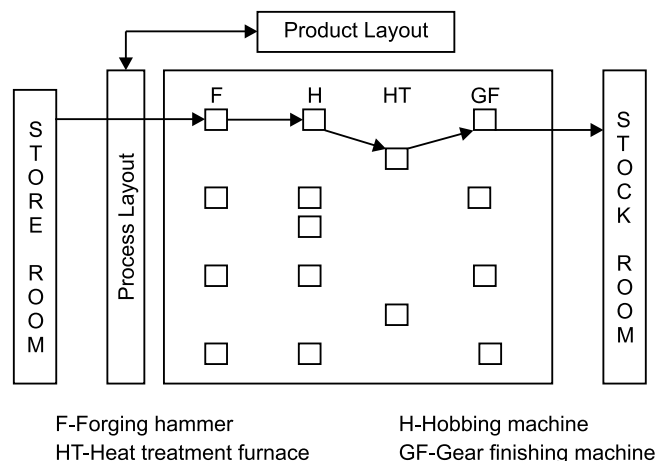

**Fig. 2.7** Combination layout for making different types and sizes of gears

### 2.8.4 Fixed Position Layout

This is also called the **project type** of layout. In this type of layout, the material, or major components remain in a fixed location and tools, machinery, men and other materials are brought to this location. This type of layout is suitable when one or a few pieces of identical heavy products are to be manufactured and when the assembly consists of large number of heavy parts, the cost of transportation of these parts is very high.

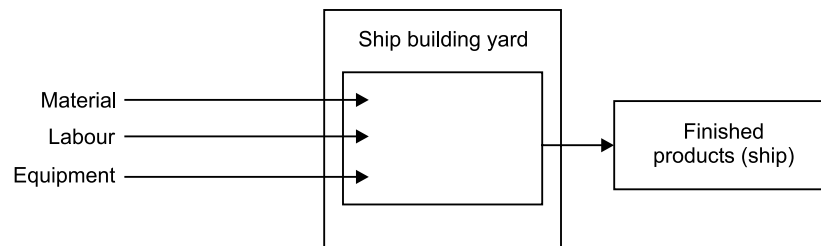

Fig. 2.8 Fixed position layout

#### Advantages

The major advantages of this type of layout are:

1. Helps in job enlargement and upgrades the skills of the operators.
2. The workers identify themselves with a product in which they take interest and pride in doing the job.
3. Greater flexibility with this type of layout.
4. Layout capital investment is lower.

### 2.8.5 Group Layout (or Cellular Layout)

There is a trend now to bring an element of flexibility into manufacturing system as regards to variation in batch sizes and sequence of operations. A grouping of equipment for performing a sequence of operations on family of similar components or products has become all the important.

Group technology (GT) is the analysis and comparisons of items to group them into families with similar characteristics. GT can be used to develop a hybrid between pure process layout and pure flow line (product) layout. This technique is very useful for companies that produce variety of parts in small batches to enable them to take advantage and economics of flow line layout.

The application of group technology involves two basic steps; first step is to determine component families or groups. The second step in applying group technology is to arrange the plants equipment used to process a particular family of components. This represents small plants within the plants. The group technology reduces production planning time for jobs. It reduces the set-up time.

Thus **group layout** is a combination of the product layout and process layout. It combines the advantages of both layout systems. If there are  $m$ -machines and  $n$ -components, in a group layout (Group-Technology Layout), the  $m$ -machines and  $n$ -components will be divided into distinct

number of machine-component cells (group) such that all the components assigned to a cell are almost processed within that cell itself. Here, the objective is to minimize the intercell movements.

The basic aim of a group technology layout is to identify families of components that require similar of satisfying all the requirements of the machines are grouped into cells. Each cell is capable of satisfying all the requirements of the component family assigned to it.

The layout design process considers mostly a single objective while designing layouts. In process layout, the objective is to minimize the total cost of materials handling. Because of the nature of the layout, the cost of equipments will be the minimum in this type of layout. In product layout, the cost of materials handling will be at the absolute minimum. But the cost of equipments would not be at the minimum if the equipments are not fully utilized.

In-group technology layout, the objective is to minimize the sum of the cost of transportation and the cost of equipments. So, this is called as multi-objective layout. A typical process layout is shown in Fig. 2.9.

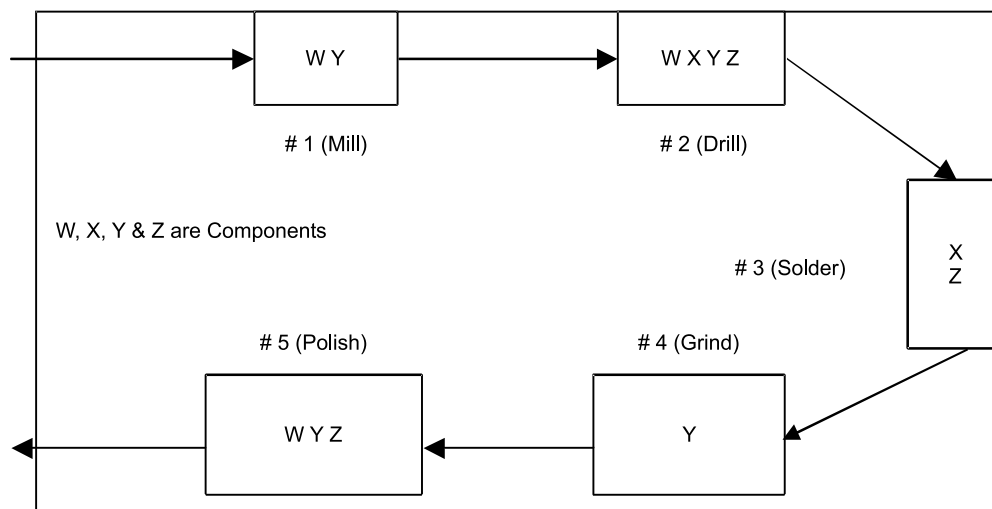

**Fig. 2.9** Group layout or Cellular layout

### Advantages of Group Technology Layout

Group Technology layout can increase—

1. Component standardization and rationalization.
2. Reliability of estimates.
3. Effective machine operation and productivity.
4. Customer service.

It can decrease the—

1. Paper work and overall production time.
2. Work-in-progress and work movement.
3. Overall cost.

### Limitations of Group Technology Layout

This type of layout may not be feasible for all situations. If the product mix is completely dissimilar, then we may not have meaningful cell formation.

## 2.9 DESIGN OF PRODUCT LAYOUT

In product layout, equipment or departments are dedicated to a particular product line, duplicate equipment is employed to avoid backtracking, and a straight-line flow of material movement is achievable. Adopting a product layout makes sense when the batch size of a given product or part is large relative to the number of different products or parts produced.

**Assembly lines** are a special case of product layout. In a general sense, the term assembly line refers to progressive assembly linked by some material-handling device. The usual assumption is that some form of pacing is present and the allowable processing time is equivalent for all workstations. Within this broad definition, there are important differences among line types. A few of these are material handling devices (belt or roller conveyor, overhead crane); line configuration (U-shape, straight, branching); pacing (mechanical, human); product mix (one product or multiple products); workstation characteristics (workers may sit, stand, walk with the line, or ride the line); and length of the line (few or many workers). The range of products partially or completely assembled on lines includes toys, appliances, autos, clothing and a wide variety of electronic components. In fact, virtually any product that has multiple parts and is produced in large volume uses assembly lines to some degree.

A more-challenging problem is the determination of the optimum configuration of operators and buffers in a production flow process. A major design consideration in production lines is the assignment of operation so that all stages are more or less equally loaded. Consider the case of traditional assembly lines illustrated in Fig. 2.10.

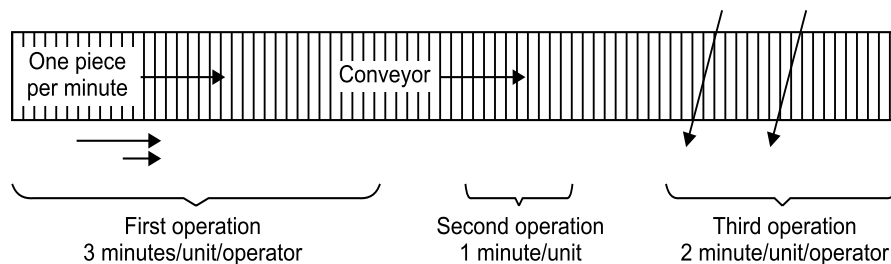

**Fig. 2.10** *Traditional assembly line*

In this example, parts move along a conveyor at a rate of one part per minute to three groups of workstations. The first operation requires 3 minutes per unit; the second operation requires 1 minute per unit; and the third requires 2 minutes per unit. The first workstation consists of three operators; the second, one operator; and the third, two operators. An operator removes a part from the conveyor and performs some assembly task at his or her workstation. The completed part is returned to the conveyor and transported to the next operation. The number of operators at each workstation was chosen so that the line is balanced. Since three operators work simultaneously at the first workstation, on the average one part will be completed each

minute. This is also true for other two stations. Since the parts arrive at a rate of one per minute, parts are also completed at this rate.

Assembly-line systems work well when there is a low variance in the times required to perform the individual subassemblies. If the tasks are somewhat complex, thus resulting in a higher assembly-time variance, operators down the line may not be able to keep up with the flow of parts from the preceding workstation or may experience excessive idle time. An alternative to a conveyor-paced assembly-line is a sequence of workstations linked by gravity conveyors, which act as buffers between successive operations.

### LINE BALANCING

Assembly-line balancing often has implications for layout. This would occur when, for balance purposes, workstation size or the number used would have to be physically modified.

The most common assembly-line is a moving conveyor that passes a series of workstations in a uniform time interval called the **workstation cycle time** (which is also the time between successive units coming off the end of the line). At each workstation, work is performed on a product either by adding parts or by completing assembly operations. The work performed at each station is made up of many bits of work, termed tasks, elements, and work units. Such tasks are described by motion-time analysis. Generally, they are grouping that cannot be subdivided on the assembly-line without paying a penalty in extra motions.

The total work to be performed at a workstation is equal to the sum of the tasks assigned to that workstation. The line-balancing problem is one of assigning all tasks to a series of workstations so that each workstation has no more than can be done in the workstation cycle time, and so that the unassigned (idle) time across all workstations is minimized.

The problem is complicated by the relationships among tasks imposed by product design and process technologies. This is called the precedence relationship, which specifies the order in which tasks must be performed in the assembly process.

The steps in balancing an assembly line are:

1. Specify the sequential relationships among tasks using a precedence diagram.
2. Determine the required workstation cycle time  $C$ , using the formula

$$C = \frac{\text{Production time per day}}{\text{Required output per day (in units)}}$$

3. Determine the theoretical minimum number of workstations ( $N_t$ ) required to satisfy the workstation cycle time constraint using the formula

$$N_t = \frac{\text{Sum of task times (T)}}{\text{Cycle time (C)}}$$

4. Select a primary rule by which tasks are to be assigned to workstations, and a secondary rule to break ties.
5. Assign tasks, one at a time, to the first workstation until the sum of the task times is equal to the workstation cycle time, or no other tasks are feasible because of time or sequence restrictions. Repeat the process for workstation 2, workstation 3, and so on until all tasks are assigned.

6. Evaluate the efficiency of the balance derived using the formula

$$\text{Efficiency} = \frac{\text{Sum of task times (T)}}{\text{Actual number of workstations (N}_a\text{)} \times \text{Workstations cycle time (C)}}$$

7. If efficiency is unsatisfactory, rebalance using a different decision rule.

**ILLUSTRATION 7:** The MS 800 car is to be assembled on a conveyor belt. Five hundred cars are required per day. Production time per day is 420 minutes, and the assembly steps and times for the wagon are given below. Find the balance that minimizes the number of workstations, subject to cycle time and precedence constraints.

Task	Task time (in seconds)	Description	Tasks that must precede
A	45	Position rear axle support and hand fasten	-
B	11	Four screws to nuts	A
C	9	Insert rear axle	B
D	50	Tighten rear axle support screws to nuts	-
E	15	Position front axle assembly and hand	D
F	12	Fasten with four screws to nuts	C
G	12	Tighten front axle assembly screws	C
H	12	Position rear wheel 1 and fasten hubcap	E
I	12	Position rear wheel 2 and fasten hubcap	E
J	8	Position front wheel 1 and fasten hubcap	F, G, H, I
K	9	Position front wheel 2 and fasten hubcap	J

**SOLUTION:** 1. Draw a precedence diagram as follows:

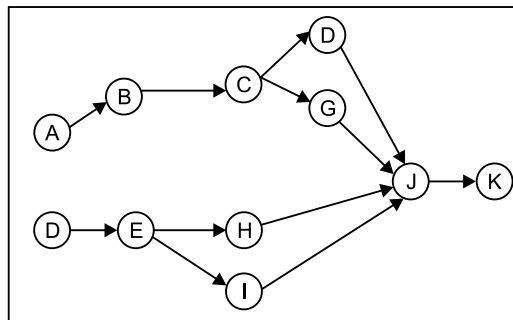

2. Determine workstation cycle time. Here we have to convert production time to seconds because our task times are in seconds

$$\begin{aligned}
 C &= \frac{\text{Production time per day}}{\text{Required output per day (in units)}} \\
 &= \frac{420 \text{ min} \times 60 \text{ sec}}{500 \text{ cars}} = \frac{25200}{500} = 50.4 \text{ secs}
 \end{aligned}$$

- Determine the theoretical minimum number of workstations required (the actual number may be greater)

$$N_t = \frac{T}{C} = \frac{195 \text{ seconds}}{50.4 \text{ seconds}} = 3.87 = 4 \text{ (rounded up)}$$

- Select assignment rules.

(a) Prioritize tasks in order of the largest number of following tasks:

<i>Task</i>	<i>Number of following tasks</i>
A	6
B or D	5
C or E	4
F, G, H, or I	2
J	1
K	0

Our secondary rule, to be invoked where ties exist from our primary rule, is (b) Prioritize tasks in order of longest task time. Note that D should be assigned before B, and E assigned before C due to this tie-breaking rule.

- Make task assignments to form workstation 1, workstation 2, and so forth until all tasks are assigned. It is important to meet precedence and cycle time requirements as the assignments are made.

<i>Station</i>	<i>Task</i>	<i>Task time (in sec)</i>	<i>Remaining unassigned time (in sec)</i>	<i>Feasible remaining tasks</i>	<i>Task with most followers</i>	<i>Task with longest operation time</i>
Station 1	A	45	5.4	Idle	None	
Station 2	D	50	0.4	Idle	None	
Station 3	B	11	39.4	C, E	C, E	E
	E	15	24.4	C, H, I	C	
	C	9	15.4	F, G, H, I	F, G, H, I	F, G, H, I
	F	12	3.4 idle	None		
Station 4	G	12	38.4	H, I	H, I	H, I
	H	12	26.4	I		
	I	12	14.4	J		
	J	8	6.4 idle	None		
Station 5	K	9	41.4 idle	None		

- Calculate the efficiency.



$$\text{Efficiency} = \frac{T}{N_d C} = \frac{195}{5 \times 50.4} = .77 \text{ or } 77\%$$

7. Evaluate the solution. An efficiency of 77 per cent indicates an imbalance or idle time of 23 per cent ( $1.0 - .77$ ) across the entire line.

In addition to balancing a line for a given cycle time, managers must also consider four other options: pacing, behavioural factors, number of models produced, and cycle times.

Pacing is the movement of product from one station to the next after the cycle time has elapsed. Paced lines have no buffer inventory. Unpaced lines require inventory storage areas to be placed between stations.

### **BEHAVIOURAL FACTORS**

The most controversial aspect of product layout is behavioural response. Studies have shown that paced production and high specialization lower job satisfaction. One study has shown that productivity increased on unpaced lines. Many companies are exploring job enlargement and rotation to increase job variety and reduce excessive specialization. For example, New York Life has redesigned the jobs of workers who process and evaluate claims applications. Instead of using a production line approach with several workers doing specialized tasks, New York Life has made each worker solely responsible for an entire application. This approach increased worker responsibility and raised morale. In manufacturing, at its plant in Kohda, Japan, Sony Corporation dismantled the conveyor belts on which as many as 50 people assembled camcorders. It set up tables for workers to assemble an entire camera themselves, doing everything from soldering to testing. Output per worker is up 10 per cent, because the approach frees efficient assemblers to make more products instead of limiting them to conveyor belt's speed. And if something goes wrong, only a small section of the plant is affected. This approach also allows the line to match actual demand better and avoid frequent shutdown because of inventory buildups.

### **NUMBER OF MODELS PRODUCED**

A mixed-model line produces several items belonging to the same family. A single-model line produces one model with no variations. Mixed model production enables a plant to achieve both high-volume production and product variety. However, it complicates scheduling and increases the need for good communication about the specific parts to be produced at each station.

### **CYCLE TIMES**

A line's cycle time depends on the desired output rate (or sometimes on the maximum number of workstations allowed). In turn, the maximum line efficiency varies considerably with the cycle time selected. Thus, exploring a range of cycle times makes sense. A manager might go with a particularly efficient solution even if it does not match the output rate. The manager can compensate for the mismatch by varying the number of hours the line operates through overtime, extending shifts, or adding shifts. Multiple lines might even be the answer.

## **2.10 DESIGN OF PROCESS LAYOUT**

The analysis involved in the design of production lines and assembly lines relates primarily to timing, coordination, and balance among individual stages in the process.

For process layouts, the relative arrangement of departments and machines is the critical factor because of the large amount of transportation and handling involved.

### PROCEDURE FOR DESIGNING PROCESS LAYOUTS

Process layout design determines the best relative locations of functional work centres. Work centres that interact frequently, with movement of material or people, should be located close together, whereas those that have little interaction can be spatially separated. One approach of designing an efficient functional layout is described below.

1. List and describe each functional work centre.
2. Obtain a drawing and description of the facility being designed.
3. Identify and estimate the amount of material and personnel flow among work centres
4. Use structured analytical methods to obtain a good general layout.
5. Evaluate and modify the layout, incorporating details such as machine orientation, storage area location, and equipment access.

The first step in the layout process is to identify and describe each work centre. The description should include the primary function of the work centre; drilling, new accounts, or cashier; its major components, including equipment and number of personnel; and the space required. The description should also include any special access needs (such as access to running water or an elevator) or restrictions (it must be in a clean area or away from heat).

For a new facility, the spatial configuration of the work centres and the size and shape of the facility are determined simultaneously. Determining the locations of special structures and fixtures such as elevators, loading docks, and bathrooms becomes part of the layout process. However, in many cases the facility and its characteristics are a given. In these situations, it is necessary to obtain a drawing of the facility being designed, including shape and dimensions, locations of fixed structures, and restrictions on activities, such as weight limits on certain parts of a floor or foundation.

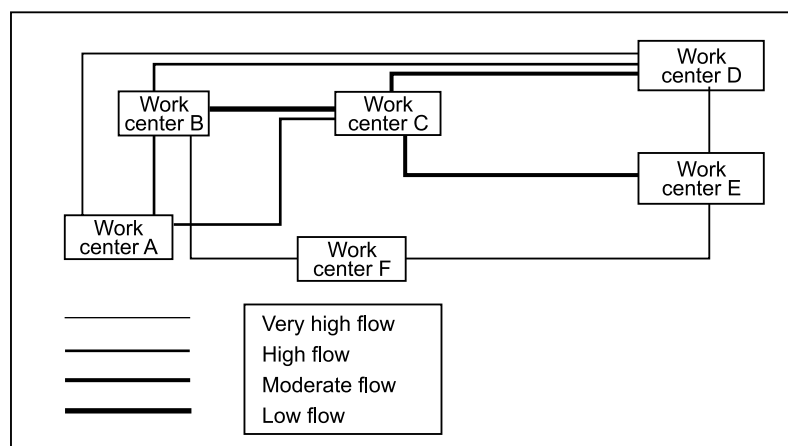

**Fig 2.11** Relationship flow diagram

To minimize transport times and material-handling costs, we would like to place close together those work centres that have the greatest flow of materials and people between them.

To estimate the flows between work centres, it is helpful to begin by drawing relationship diagram as shown in Fig. 2.11.

For manufacturing systems, material flows and transporting costs can be estimated reasonably well using historical routings for products or through work sampling techniques applied to workers or jobs. The flow of people, especially in a service system such as a business office or a university administration building, may be difficult to estimate precisely, although work sampling can be used to obtain rough estimates.

The amounts and/or costs of flows among work centres are usually presented using a flow matrix, a flow-cost matrix, or a proximity chart.

### 1. Flow Matrix

A flow matrix is a matrix of the estimated amounts of flow between each pair of work centres. The flow may be materials (expressed as the number of loads transported) or people who move between centres. Each work centre corresponds to one row and one column, and the element  $f_{ij}$  designates the amount of flow from work centre (row)  $i$  to work centre (column)  $j$ . Normally, the direction of flow between work centres is not important, only the total amount, so  $f_{ij}$  and  $f_{ji}$  can be combined and the flows represented using only the upper right half of a matrix.

Flow Matrix Table

Work centre										
	A	B	C	D	E	F	G	H	I	
A	-	25	32	0	80	0	30	5	15	Daily flows between work centres
B	-	-	20	10	30	75	0	7	10	
C	-	-	-	0	10	50	45	60	0	
D	-	-	-	-	35	0	25	90	120	
E	-	-	-	-	-	20	80	0	70	
F	-	-	-	-	-	-	0	150	20	
G	-	-	-	-	-	-	-	50	45	
H	-	-	-	-	-	-	-	-	80	
I	-	-	-	-	-	-	-	-	-	

### 2. Flow-cost Matrix

A basic assumption of facility layout is that the cost of moving materials or people between work centers is a function of distance travelled. Although more complicated cost functions can be accommodated, often we assume that the per unit cost of material and personnel flows between work centres is proportional to the distance between the centres. So for each type of flow between each pair of departments,  $i$  and  $j$ , we estimate the cost per unit per unit distance,  $c_{ij}$ .

Flow-cost Matrix Table

Work centre										Daily cost for flows between work centres (Rs per day per 100 ft)
	A	B	C	D	E	F	G	H	I	
A	-	25	32	0	80	0	30	5	15	
B	-	-	40	10	90	75	0	7	10	
C	-	-	-	0	10	50	45	60	0	
D	-	-	-	-	35	0	50	90	240	
E	-	-	-	-	-	20	80	0	70	
F	-	-	-	-	-	-	0	150	20	
G	-	-	-	-	-	-	-	150	45	
H	-	-	-	-	-	-	-	-	80	
I	-	-	-	-	-	-	-	-	-	

### 3. Proximity Chart

Proximity charts (relationship charts) are distinguished from flow and flow-cost matrices by the fact that they describe qualitatively the desirability or need for work centres to be close together, rather than providing quantitative measures of flow and cost. These charts are used when it is difficult to measure or estimate precise amounts or costs of flow among work centres. This is common when the primary flows involve people and do not have a direct cost but rather an indirect cost, such as when employees in a corporate headquarters move among departments (payroll, printing, information systems) to carry out their work.

## 2.11 SERVICE LAYOUT

The major factors considered for service providers, is an impact of location on sales and customer satisfaction. Customers usually look about how close a service facility is, particularly if the process requires considerable customer contact. Hence, service facility layouts should provide for easy entrance to these facilities from the freeways. Well-organized packing areas, easily accessible facilities, well designed walkways and parking areas are some of the requirements of service facility layout.

Service facility layout will be designed based on degree of customer contact and the service needed by a customer. These service layouts follow conventional layouts as required. For example, for car service station, product layout is adopted, where the activities for servicing a car follows a sequence of operation irrespective of the type of car. Hospital service is the best example for adaptation of process layout. Here, the service required for a customer will follow an independent path. The layout of car servicing and hospital is shown in Figs. 2.12 and 2.13.

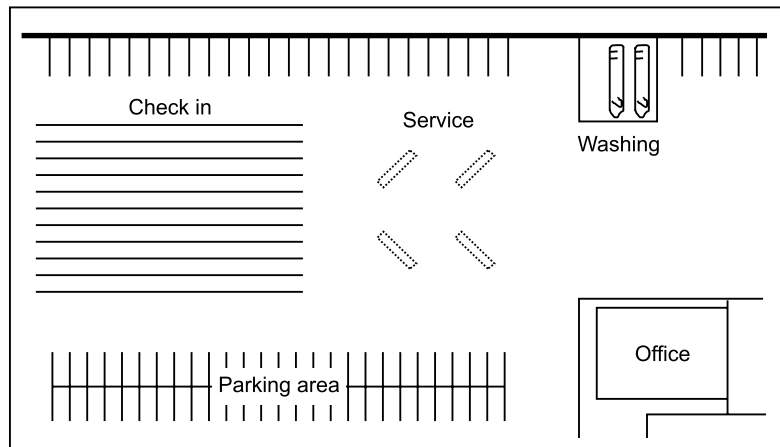

**Fig. 2.12** Service layout for car servicing

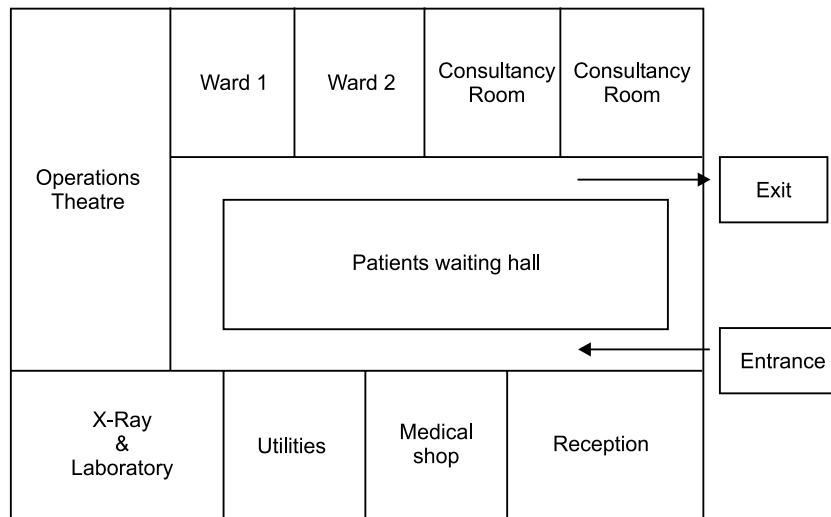

**Fig. 2.13** Layout for hospitality service

## 2.12 ORGANISATION OF PHYSICAL FACILITIES

The following are the most important physical facilities to be organised:

1. Factory building
2. Lighting
3. Climatic conditions
4. Ventilation
5. Work-related welfare facilities

### I. FACTORY BUILDING

Factory building is a factor which is the most important consideration for every industrial enterprise. A modern factory building is required to provide protection for men, machines, materials, products

or even the company's secrets. It has to serve as a part of the production facilities and as a factor to maximise economy and efficiency in plant operations. It should offer a pleasant and comfortable working environment and project the management's image and prestige. Factory building is like skin and bones of a living body for an organisation. It is for these reasons that the factory building acquires great importance.

Following factors are considered for an Industrial Building:

- A. Design of the building.
- B. Types of buildings.

### A. Design of the Building

The building should be designed so as to provide a number of facilities—such as lunch rooms, cafeteria, locker rooms, crèches, libraries, first-aid and ambulance rooms, materials handling facilities, heating, ventilation, air-conditioning, etc. Following factors are considerations in the designing of a factory building:

1. **Flexibility:** Flexibility is one of the important considerations because the building is likely to become obsolete and provides greater operating efficiency even when processes and technology change. Flexibility is necessary because it is not always feasible and economical to build a new plant, every time a new firm is organised or the layout is changed. With minor alternations, the building should be able to accommodate different types of operations.

2. **Product and equipment:** The type of product that is to be manufactured, determines column-spacing, type of floor, ceiling, heating and air-conditioning. A product of a temporary nature may call for a less expensive building and that would be a product of a more permanent nature. Similarly, a heavy product demands a far more different building than a product which is light in weight.

3. **Expansibility:** Growth and expansion are natural to any manufacturing enterprises. They are the indicators of the prosperity of a business. The following factors should be borne in mind if the future expansion of the concern is to be provided for:

- (i) The *area of the land* which is to be acquired should be large enough to provide for the future expansion needs of the firm and accommodate current needs.
- (ii) The *design of the building* should be in a rectangular shape. Rectangular shapes facilitate expansion on any side.
- (iii) If *vertical expansion* is expected, strong foundations, supporters and columns must be provided.
- (iv) If *horizontal expansion* is expected, the side walls must be made non-load-bearing to provide for easy removal.

4. **Employee facilities and service area:** Employee facilities must find a proper place in the building design because they profoundly affect the morale, comfort and productivity. The building plan should include facilities for lunch rooms, cafeteria, water coolers, parking area and the like. The provision of some of these facilities is a legal requirement. Others make good working conditions possible. And a good working condition is good business.

Service areas, such as the tool room, the supervisor's office, the maintenance room, receiving and dispatching stations, the stock room and facilities for scrap disposal, should also be included in the building design.

## **B. Types of Buildings**

Industrial buildings may be grouped under three types:

1. Single-storey buildings,
2. Multi-storey buildings

The decision on choosing a suitable type for a particular firm depends on the manufacturing process and the area of land and the cost of construction.

### **1. SINGLE-STOREY BUILDINGS**

Most of the industrial buildings manufacturing which are now designed and constructed are single storeyed, particularly where lands are available at reasonable rates. Single-storey buildings offer several operating advantages. A single-storey construction is preferable when materials handling is difficult because the product is big or heavy, natural lighting is desired, heavy floor loads are required and frequent changes in layout are anticipated.

#### **Advantages**

Advantages of single-storey building are:

1. There is a greater flexibility in layout and production routing.
2. The maintenance cost resulting from the vibration of machinery is reduced considerably because of the housing of the machinery on the ground.
3. Expansion is easily ensured by the removal of walls.
4. The cost of transportation of materials is reduced because of the absence of materials handling equipment between floors.
5. All the equipment is on the same level, making for an easier and more effective layout supervision and control.
6. Greater floor load-bearing capacity for heavy equipment is ensured.
7. The danger of fire hazards is reduced because of the lateral spread of the building.

#### **Limitations**

Single-storey buildings suffer from some limitations. These are:

1. High cost of land, particularly in the city.
2. High cost of heating, ventilating and cleaning of windows.
3. High cost of transportation for moving men and materials to the factory which is generally located far from the city.

### **2. MULTI-STOREY BUILDINGS**

Schools, colleges, shopping complexes, and residences, and for service industries like Software, BPO etc. multi-storey structures are generally popular, particularly in cities. Multi-storey buildings are useful in manufacture of light products, when the acquisition of land becomes difficult and expensive and when the floor load is less.

**Advantages**

When constructed for industrial use, multi-storey buildings offer the following advantages:

1. Maximum operating floor space (per sq. ft. of land). This is best suited in areas where land is very costly.
2. Lower cost of heating and ventilation.
3. Reduced cost of materials handling because the advantage of the use of gravity for the flow of materials.

**Limitations**

Following are the disadvantages of multi-storey building:

1. Materials handling becomes very complicated. A lot of time is wasted in moving them between floors.
2. A lot of floor space is wasted on elevators, stairways and fire escapes.
3. Floor load-bearing capacity is limited, unless special construction is used, which is very expensive.
4. Natural lighting is poor in the centres of the shop, particularly when the width of the building is somewhat great.
5. Layout changes cannot be effected easily and quickly.

Generally speaking, textile mills, food industries, detergent plants, chemical industries and software industry use these types of buildings.

**II. LIGHTING**

It is estimated that 80 per cent of the information required in doing job is perceived visually. Good visibility of the equipment, the product and the data involved in the work process is an essential factor in accelerating production, reducing the number of defective products, cutting down waste and preventing visual fatigue and headaches among the workers. It may also be added that both inadequate visibility and glare are frequently causes accidents.

In principle, lighting should be adapted to the type of work. However, the level of illumination, measured in should be increased not only in relation to the degree of precision or miniaturization of the work but also in relation to the worker's age. The accumulation of dust and the wear of the light sources cut down the level of illumination by 10–50 per cent of the original level. This gradual drop in the level should therefore be compensated for when designing the lighting system. Regular cleaning of lighting fixture is obviously essential.

Excessive contrasts in lighting levels between the worker's task and the general surroundings should also be avoided. The use of natural light should be encouraged. This can be achieved by installing windows that open, which are recommended to have an area equal to the time of day, the distance of workstations from the windows and the presence or absence of blinds. For this reason it is essential to have artificial lighting, will enable people to maintain proper vision and will ensure that the lighting intensity ratios between the task, the surrounding objects and the general environment are maintained.



### **CONTROL OF LIGHTING**

In order to make the best use of lighting in the work place, the following points should be taken into account:

1. For uniform light distribution, install an independent switch for the row of lighting fixtures closest to the windows. This allows the lights to be switched on and off depending on whether or not natural light is sufficient.
2. To prevent glare, avoid using highly shiny, glossy work surfaces.
3. Use localized lighting in order to achieve the desired level for a particular fine job.
4. Clean light fixtures regularly and follow a maintenance schedule so as to prevent flickering of old bulbs and electrical hazards due to worn out cables.
5. Avoid direct eye contact with the light sources. This is usually achieved by positioning them property. The use of diffusers is also quite effective.

### **III. CLIMATIC CONDITIONS**

Control of the climatic conditions at the workplace is paramount importance to the workers health and comfort and to the maintenance of higher productivity. With excess heat or cold, workers may feel very uncomfortable, and their efficiency drops. In addition, this can lead to accidents.

This human body functions in such a way as to keep the central nervous system and the internal organs at a constant temperature. It maintains the necessary thermal balance by continuous heat exchange with the environment. It is essential to avoid excessive heat or cold, and wherever possible to keep the climatic conditions optimal so that the body can maintain a thermal balance.

#### **WORKING IN A HOT ENVIRONMENT**

Hot working environments are found almost everywhere. Work premise in tropical countries may, on account of general climatic conditions, be naturally hot. When source of heat such as furnaces, kilns or hot processes are present, or when the physical workload is heavy, the human body may also have to deal with excess heat. It should be noted that in such hot working environments sweating is almost the only way in which the body can lose heat. As the sweat evaporates, the body cools. There is a relationship between the amount and speed of evaporation and a feeling of comfort. The more intense the evaporation, the quicker the body will cool and feel refreshed. Evaporation increases with adequate ventilation.

#### **WORKING IN A COLD ENVIRONMENT**

Working in cold environments was once restricted to non-tropical or highly elevated regions. Now as a result of modern refrigeration, various groups of workers, even in tropical countries, are exposed to a cold environment.

Exposure to cold for short periods of time can produce serious effects, especially when workers are exposed to temperatures below 10°C The loss of body heat is uncomfortable and quickly affects work efficiency. Workers in cold climates and refrigerated premises should be well protected against the cold by wearing suitable clothes, including footwear, gloves and, most importantly, a hat. Normally, dressing in layers traps dead air and serves as an insulation layer, thus keeping the worker warmer.

### CONTROL OF THE THERMAL ENVIRONMENT

There are many ways of controlling the thermal environment. It is relatively easy to assess the effects of thermal conditions, especially when excessive heat or cold is an obvious problem. To solve the problem, however, consistent efforts using a variety of available measures are usually necessary. This is because the problem is linked with the general climate, which greatly affects the workplace climate, production technology, which is often the source of heat or cold and varying conditions of the work premises as well as work methods and schedules. Personal factors such as clothing, nutrition, personal habits, and age and individual differences in response to the given thermal conditions also need to be taken into account in the attempt to attain the thermal comfort of workers.

In controlling the thermal environment, one or more of the following **principles** may be applied:

1. Regulating workroom temperature by preventing outside heat or cold from entering (improved design of the roof, insulation material or installing an air-conditioned workroom. Air-conditioning is costly, especially in factories. But it is sometimes a worthwhile investment if an appropriate type is chosen);
2. provision of ventilation in hot workplaces by increasing natural ventilating through openings or installing ventilation devices;
3. separation of heat sources from the working area, insulation of hot surfaces and pipes, or placement of barriers between the heat sources and the workers;
4. control of humidity with a view to keeping it at low levels, for example by preventing the escape of steam from pipes and equipment;
5. Provision of adequate personal protective clothing and equipment for workers exposed to excessive radiant heat or excessive cold (heat-protective clothing with high insulation value may not be recommended for jobs with long exposure to moderate or heavy work as it prevents evaporative heat loss);
6. Reduction of exposure time, for example, by mechanization, remote control or alternating work schedules;
7. Insertion of rest pauses between work periods, with comfortable, if possible air-conditioned, resting facilities;
8. Ensuring a supply of cold drinking-water for workers in a hot environment and of hot drinks for those exposed to a cold environment.

### IV. VENTILATION

Ventilation is the dynamic parameter that complements the concept of air space. For a given number of workers, the smaller the work premises the more should be the ventilation.

Ventilation differs from air circulation. Ventilation replaces contaminated air by fresh air, whereas as the air-circulation merely moves the air without renewing it. Where the air temperature and humidity are high, merely to circulate the air is not only ineffective but also increases heat absorption. Ventilation disperses the heat generated by machines and people at work. Adequate ventilation should be looked upon as an important factor in maintaining the worker's health and productivity.

Except for confined spaces, all working premises have some minimum ventilation. However, to ensure the necessary air flow (which should not be lower than 50 cubic metres of air per hour per worker), air usually needs to be changed between four to eight times per hour in offices or for sedentary workers, between eight and 12 times per hour in workshops and as much as 15 to 30 or more times per hour for public premises and where there are high levels of atmospheric pollution or humidity. The air speed used for workplace ventilation should be adapted to the air temperature and the energy expenditure: for sedentary work it should exceed 0.2 metre per second, but for a hot environment the optimum speed is between 0.5 and 1 metre per second. For hazardous work it may be even higher. Certain types of hot work can be made tolerable by directing a stream of cold air at the workers.

Natural ventilation, obtained by opening windows or wall or roof airvents, may produce significant air flows but can normally be used only in relatively mild climates. The effectiveness of this type of ventilation depends largely on external conditions. Where natural ventilation is inadequate, artificial ventilation should be used. A choice may be made between a blown-air system, an exhaust air system or a combination of both ('push-pull' ventilation). Only 'push-pull' ventilation systems allow for better regulation of air movement.

## **V. WORK-RELATED WELFARE FACILITIES**

Work-related welfare facilities offered at or through the workplace can be important factors. Some facilities are very basic, but often ignored, such as drinking-water and toilets. Others may seem less necessary, but usually have an importance to workers far greater than their cost to the enterprise.

### **1. DRINKING WATER**

Safe, cool drinking water is essential for all types of work, especially in a hot environment. Without it fatigue increases rapidly and productivity falls. Adequate drinking water should be provided and maintained at convenient points, and clearly marked as "Safe drinking water". Where possible it should be kept in suitable vessels, renewed at least daily, and all practical steps taken to preserve the water and the vessels from contamination.

### **2. SANITARY FACILITIES**

Hygienic sanitary facilities should exist in all workplaces. They are particularly important where chemicals or other dangerous substances are used. Sufficient toilet facilities, with separate facilities for men and women workers, should be installed and conveniently located. Changing-rooms and cloakrooms should be provided. Washing facilities, such as washbasins with soap and towels, or showers, should be placed either within changing-rooms or close by.

### **3. FIRST-AID AND MEDICAL FACILITIES**

Facilities for rendering first-aid and medical care at the workplace in case of accidents or unforeseen sickness are directly related to the health and safety of the workers. First-aid boxes should be clearly marked and conveniently located. They should contain only first-aid requisites of a prescribed standard and should be in the charge of qualified person. Apart from first-aid boxes, it is also desirable to have a stretcher and suitable means to transport injured persons to a centre where medical care can be provided.

#### **4. REST FACILITIES**

Rest facilities can include seats, rest-rooms, waiting rooms and shelters. They help workers to recover from fatigue and to get away from a noisy, polluted or isolated workstation. A sufficient number of suitable chairs or benches with backrests should be provided and maintained, including seats for occasional rest of workers who are obliged to work standing up. Rest-rooms enable workers to recover during meal and rest breaks.

#### **5. FEEDING FACILITIES**

It is now well recognized that the health and work capacity of workers to have light refreshments are needed. A full meal at the workplace is necessary when the workers live some distance away and when the hours of work are so organized that the meal breaks are short. A snack bar, buffet or mobile trolleys can provide tea, coffee and soft drinks, as well as light refreshments. Canteens or a restaurant can allow workers to purchase a cheap, well-cooked and nutritious meal for a reasonable price and eat in a clean, comfortable place, away from the workstation.

#### **6. CHILD-CARE FACILITIES**

Many employers find that working mothers are especially loyal and effective workers, but they often face the special problems of carrying for children. It is for this reason that child-care facilities, including crèches and day-care centres, should be provided. These should be in secure, airy, clean and well lit premises. Children should be looked after properly by qualified staff and offered food, drink education and play at very low cost.

#### **7. RECREATIONAL FACILITIES**

Recreational facilities offer workers the opportunity to spend their leisure time in activities likely to increase physical and mental well-being. They may also help to improve social relations within the enterprise. Such facilities can include halls for recreation and for indoor and outdoor sports, reading-rooms and libraries, clubs for hobbies, picnics and cinemas. Special educational and vocational training courses can also be organized.

### **EXERCISES**

---

#### **Section A**

1. What do you mean by plant location?
2. What is virtual proximity?
3. What is virtual factory?
4. What is agglomeration?
5. What is degglomeration?
6. What is plant layout?
7. Mention any four objectives of plant layout.

#### **Section B**

1. Explain different operations strategies in case of location choice for existing organisation.
2. Explain the factors to be considered while selecting the location for the new organisation.
3. Explain the reasons for global or foreign location.

4. Explain the Alfred Weber's theory of the location of industries.
5. Explain the objectives of plant layout.
6. Explain the main principles of plant layout.
7. Explain the factors considered for an industrial building.

### **Section C**

1. Explain the need for selecting a suitable location.
2. Explain the factors influencing plant location.
3. Explain the different types of layouts.
4. Explain the physical facilities required in an organisation/factory.

### **Skill Development**

**FAST FOOD RESTAURANT VISIT:** Get the information for the following questions:

1. The locational factors considered for establishing the enterprise.
2. Strategy adopted for identifying the location [Ex: factor rating, load, distances method etc.]
3. Type of layout.
4. Physical facilities existing [line lighting ventilators, type of building etc.]

# 3

## MATERIAL HANDLING

### CHAPTER OUTLINE

- |  |   |
|--|---|
| 3.1 <i>Introduction and Meaning</i>                  | 3.7 <i>Guidelines for Effective Utilisation of Material Handling Equipments</i> |
| 3.2 <i>Objectives of Material Handling</i>           | 3.8 <i>Relationship Between Plant Layout and Material Handling</i>              |
| 3.3 <i>Principles of Material Handling</i>           | • <i>Exercises</i>  |
| 3.4 <i>Selection of Material Handling Equipments</i> | • <i>Skill Development</i>  |
| 3.5 <i>Evaluation of Material Handling System</i>    |   |
| 3.6 <i>Material Handling Equipments</i>              |   |

### 3.1 INTRODUCTION AND MEANING

Haynes defines “*Material handling embraces the basic operations in connection with the movement of bulk, packaged and individual products in a semi-solid or solid state by means of gravity manually or power-actuated equipment and within the limits of individual producing, fabricating, processing or service establishment*”. Material handling does not add any value to the product but adds to the cost of the product and hence it will cost the customer more. So the handling should be kept at minimum. Material handling in Indian industries accounts for nearly 40% of the cost of production. Out of the total time spent for manufacturing a product, 20% of the time is utilised for actual processing on them while the remaining 80% of the time is spent in moving from one place to another, waiting for the processing. Poor material handling may result in delays leading to idling of equipment.

Materials handling can be also defined as ‘*the function dealing with the preparation, placing and positioning of materials to facilitate their movement or storage*’. Material handling is the art and science involving the movement, handling and storage of materials during different stages of manufacturing. Thus the function includes every consideration of the product except the actual processing operation. In many cases, the handling is also included as an integral part of the process. Through scientific material handling considerable reduction in the cost as well as in the production cycle time can be achieved.

### 3.2 OBJECTIVES OF MATERIAL HANDLING

Following are the objectives of material handling:

1. Minimise cost of material handling.
2. Minimise delays and interruptions by making available the materials at the point of use at right quantity and at right time.
3. Increase the productive capacity of the production facilities by effective utilisation of capacity and enhancing productivity.
4. Safety in material handling through improvement in working condition.
5. Maximum utilisation of material handling equipment.
6. Prevention of damages to materials.
7. Lower investment in process inventory.

### 3.3 PRINCIPLES OF MATERIAL HANDLING

Following are the principles of material handling:

1. **Planning principle:** All handling activities should be planned.
2. **Systems principle:** Plan a system integrating as many handling activities as possible and co-ordinating the full scope of operations (receiving, storage, production, inspection, packing, warehousing, supply and transportation).
3. **Space utilisation principle:** Make optimum use of cubic space.
4. **Unit load principle:** Increase quantity, size, weight of load handled.
5. **Gravity principle:** Utilise gravity to move a material wherever practicable.
6. **Material flow principle:** Plan an operation sequence and equipment arrangement to optimise material flow.
7. **Simplification principle:** Reduce combine or eliminate unnecessary movement and/or equipment.
8. **Safety principle:** Provide for safe handling methods and equipment.
9. **Mechanisation principle:** Use mechanical or automated material handling equipment.
10. **Standardisation principle:** Standardise method, types, size of material handling equipment.
11. **Flexibility principle:** Use methods and equipment that can perform a variety of task and applications.
12. **Equipment selection principle:** Consider all aspect of material, move and method to be utilised.
13. **Dead weight principle:** Reduce the ratio of dead weight to pay load in mobile equipment.
14. **Motion principle:** Equipment designed to transport material should be kept in motion.
15. **Idle time principle:** Reduce idle time/unproductive time of both MH equipment and man power.
16. **Maintenance principle:** Plan for preventive maintenance or scheduled repair of all handling equipment.

17. **Obsolescence principle:** Replace obsolete handling methods/equipment when more efficient method/equipment will improve operation.
18. **Capacity principle:** Use handling equipment to help achieve its full capacity.
19. **Control principle:** Use material handling equipment to improve production control, inventory control and other handling.
20. **Performance principle:** Determine efficiency of handling performance in terms of cost per unit handled which is the primary criterion.

**3.4****SELECTION OF MATERIAL HANDLING EQUIPMENTS**

Selection of Material Handling equipment is an important decision as it affects both cost and efficiency of handling system. The following factors are to be taken into account while selecting material handling equipment.

**1. PROPERTIES OF THE MATERIAL**

Whether it is solid, liquid or gas, and in what size, shape and weight it is to be moved, are important considerations and can already lead to a preliminary elimination from the range of available equipment under review. Similarly, if a material is fragile, corrosive or toxic this will imply that certain handling methods and containers will be preferable to others.

**2. LAYOUT AND CHARACTERISTICS OF THE BUILDING**

Another restricting factor is the availability of space for handling. Low-level ceiling may preclude the use of hoists or cranes, and the presence of supporting columns in awkward places can limit the size of the material-handling equipment. If the building is multi-storeyed, chutes or ramps for industrial trucks may be used. Layout itself will indicate the type of production operation (continuous, intermittent, fixed position or group) and can indicate some items of equipment that will be more suitable than others. Floor capacity also helps in selecting the best material handling equipment.

**3. PRODUCTION FLOW**

If the flow is fairly constant between two fixed positions that are not likely to change, fixed equipment such as conveyors or chutes can be successfully used. If, on the other hand, the flow is not constant and the direction changes occasionally from one point to another because several products are being produced simultaneously, moving equipment such as trucks would be preferable.

**4. COST CONSIDERATIONS**

This is one of the most important considerations. The above factors can help to narrow the range of suitable equipment, while costing can help in taking a final decision. Several cost elements need to be taken into consideration when comparisons are made between various items of equipment that are all capable of handling the same load. Initial investment and operating and maintenance costs are the major cost to be considered. By calculating and comparing the total cost for each of the items of equipment under consideration, a more rational decision can be reached on the most appropriate choice.



### 5. NATURE OF OPERATIONS

Selection of equipment also depends on nature of operations like whether handling is temporary or permanent, whether the flow is continuous or intermittent and material flow pattern-vertical or horizontal.

### 6. ENGINEERING FACTORS

Selection of equipment also depends on engineering factors like door and ceiling dimensions, floor space, floor conditions and structural strength.

### 7. EQUIPMENT RELIABILITY

Reliability of the equipment and supplier reputation and the after sale service also plays an important role in selecting material handling equipments.

## 3.5 EVALUATION OF MATERIAL HANDLING SYSTEM

The cost factors include investment cost, labour cost, and anticipated service hours per year, utilization, and unit load carrying ability, loading and unloading characteristics, operating costs and the size requirements are the factors for evolution of material handling equipment. Other factors to be considered are source of power, conditions where the equipment has to operate and such other technical aspects. Therefore, choices of equipments in organisation will improve the material handling system through work study techniques. They usually result in improving the ratio of operating time to loading time through palletizing, avoiding duplicative movements, etc. Obsolete handling systems can be replaced with more efficient equipments.

The effectiveness of the material handling system can be measured in terms of the ratio of the time spent in the handling to the total time spent in production. This will cover the time element. The cost effectiveness can be measured by the expenses incurred per unit weight handled. It can be safely said that very few organisations try to collate the expenses and time in this manner so as to objectively view the performance and to take remedial measures. Some of the other indices which can be used for evaluating the performance of handling systems are listed below:

### EQUIPMENT UTILISATION RATIO

Equipment utilisation ratio is an important indicator for judging the materials handling system. This ratio can be computed and compared with similar firms or in the same over a period of time.

In order to know the total effort needed for moving materials, it may be necessary to compute **Materials Handling Labour (MHL) ratio**. This ratio is calculated as under:

$$\text{MHL} = \frac{\text{Personnel assigned to materials handling}}{\text{Total operating work force}}$$

In order to ascertain whether is the handling system delivers materials work centres with maximum efficiency, it is desirable to compute direct labour handling loss ratio. The ratio is:

$$\text{DLHL} = \frac{\text{Materials handling time lost of labour}}{\text{Total direct labour time}}$$

The movement's operations ratio which is calculated after dividing total number of moves by total number of productive operations indicates whether the workers are going through too many motions because of poor routing.

It should, however, be emphasized that the efficiency of materials handling mainly depends on the following factors: (i) efficiency of handling methods employed for handling a unit weight through a unit distance, (ii) efficiency of the layout which determines the distance through which the materials have to be handled, (iii) utilisation of the handling facilities, and (iv) efficiency of the speed of handling.

In conclusion, it can be said that an effective material handling system depends upon tailoring the layout and equipments to suit specific requirements. When a large volume has to be moved from a limited number of sources to a limited number of destinations the fixed path equipments like rollers, belt conveyors, overhead conveyors and gantry cranes are preferred. For increased flexibility varied path equipments are preferred.

### 3.6 MATERIAL HANDLING EQUIPMENTS

Broadly material handling equipment's can be classified into two categories, namely: (a) Fixed path equipments, and (b) Variable path equipments.

- (a) *Fixed path equipments* which move in a fixed path. Conveyors, monorail devices, chutes and pulley drive equipments belong to this category. A slight variation in this category is provided by the overhead crane, which though restricted, can move materials in any manner within a restricted area by virtue of its design. Overhead cranes have a very good range in terms of hauling tonnage and are used for handling bulky raw materials, stacking and at times palletizing.
- (b) *Variable path equipments* have no restrictions in the direction of movement although their size is a factor to be given due consideration trucks, forklifts mobile cranes and industrial tractors belong to this category. Forklifts are available in many ranges, they are manoeuvrable and various attachments are provided to increase their versatility.

Material Handling Equipments may be classified in five major categories.

#### 1. CONVEYORS

Conveyors are useful for moving material between two fixed workstations, either continuously or intermittently. They are mainly used for continuous or mass production operations—indeed, they are suitable for most operations where the flow is more or less steady. Conveyors may be of various types, with rollers, wheels or belts to help move the material along: these may be power-driven or may roll freely. The decision to provide conveyors must be taken with care, since they are usually costly to install; moreover, they are less flexible and, where two or more converge, it is necessary to coordinate the speeds at which the two conveyors move.

#### 2. INDUSTRIAL TRUCKS

Industrial trucks are more flexible in use than conveyors since they can move between various points and are not permanently fixed in one place. They are, therefore, most suitable for intermittent

production and for handling various sizes and shapes of material. There are many types of truck-petrol-driven, electric, hand-powered, and so on. Their greatest advantage lies in the wide range of attachments available; these increase the trucks ability to handle various types and shapes of material.

### 3. CRANES AND HOISTS

The major advantage of cranes and hoists is that they can move heavy materials through overhead space. However, they can usually serve only a limited area. Here again, there are several types of crane and hoist, and within each type there are various loading capacities. Cranes and hoists may be used both for intermittent and for continuous production.

### 4. CONTAINERS

These are either 'dead' containers (*e.g.* Cartons, barrels, skids, pallets) which hold the material to be transported but do not move themselves, or 'live' containers (*e.g.* wagons, wheelbarrows or computer self-driven containers). Handling equipments of this kind can both contain and move the material, and is usually operated manually.

### 5. ROBOTS

Many types of robot exist. They vary in size, and in function and manoeuvrability. While many robots are used for handling and transporting material, others are used to perform operations such as welding or spray painting. An advantage of robots is that they can perform in a hostile environment such as unhealthy conditions or carry on arduous tasks such as the repetitive movement of heavy materials.

The choice of material-handling equipment among the various possibilities that exist is not easy. In several cases the same material may be handled by various types of equipments, and the great diversity of equipment and attachments available does not make the problem any easier. In several cases, however, the nature of the material to be handled narrows the choice. Some of the material handling equipment are shown in Figs. 3.1 to 3.11.

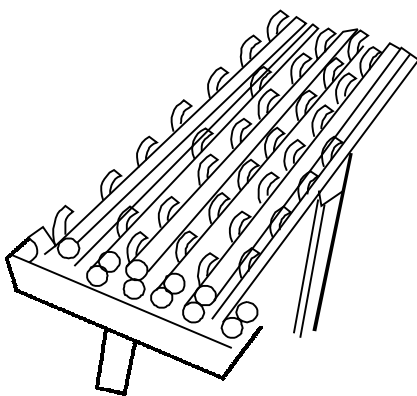

Fig. 3.1 Wheel conveyor

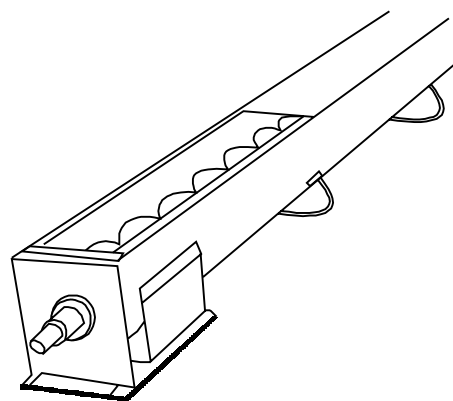
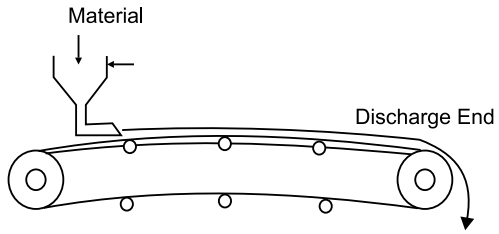
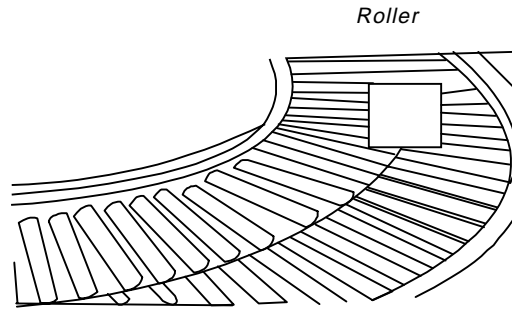

Fig. 3.2 Screw conveyor



**Fig. 3.3** *Belt conveyor*



**Fig. 3.4** *Roller conveyor*

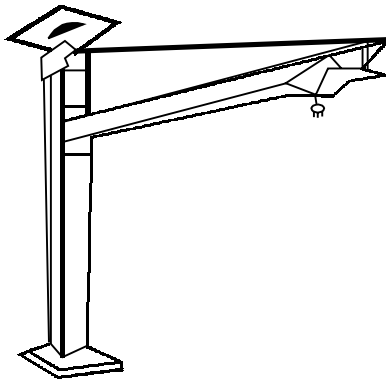

**Fig. 3.5** *Jib crane*

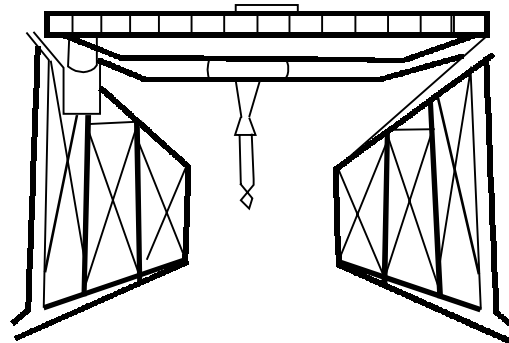

**Fig. 3.6** *Bridge crane*

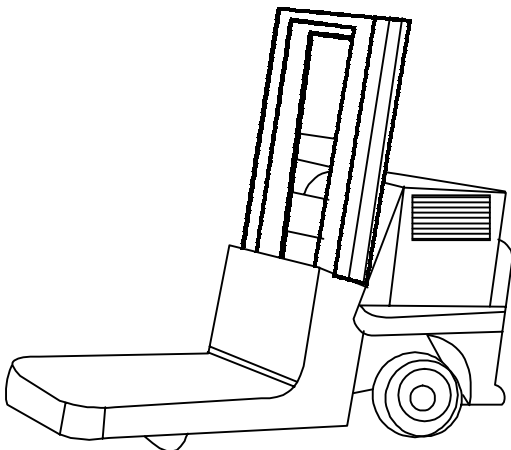

**Fig. 3.7** *Platform truck*

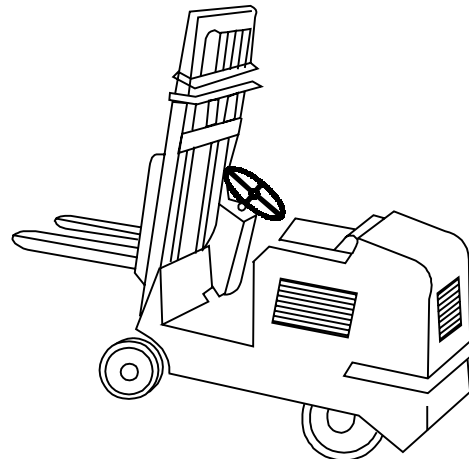

**Fig. 3.8** *Fork truck*

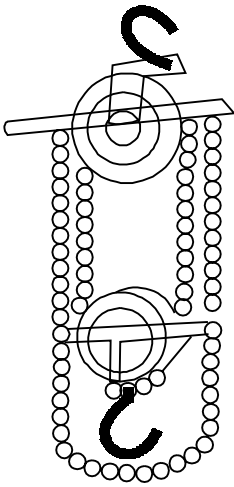

Fig. 3.9 Chain hoist

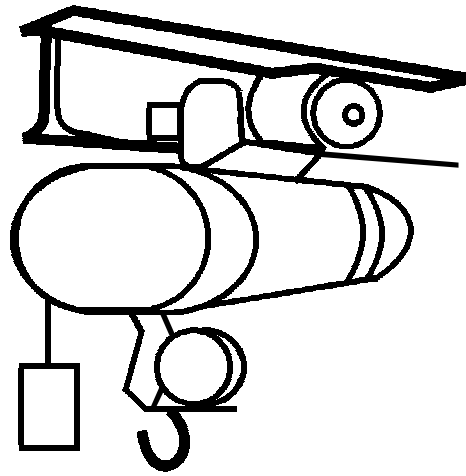

Fig. 3.10 Electric hoist

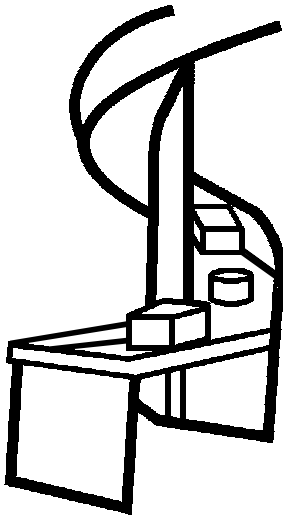

Fig. 3.11 Spiral chute

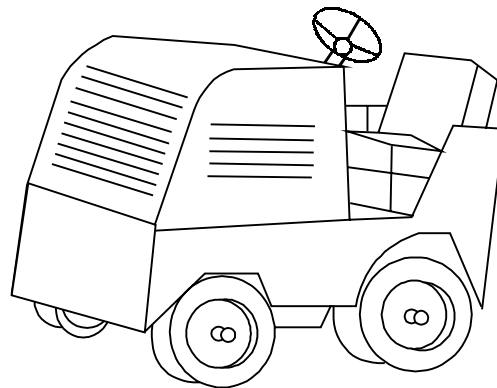

Fig. 3.12 Industrial tractor

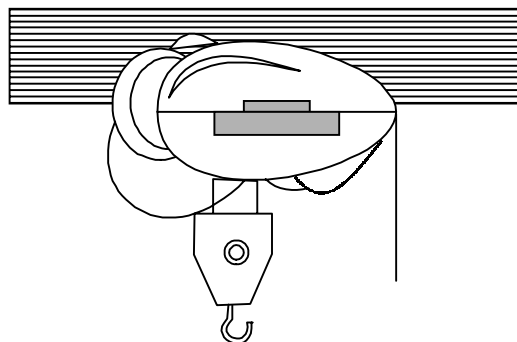

Fig. 3.13 Electrical hoist

### **3.7 GUIDELINES FOR EFFECTIVE UTILISATION OF MATERIAL HANDLING EQUIPMENTS**

The following guidelines are invaluable in the design and cost reduction of the materials handling system:

1. As material handling adds no value but increases the production cycle time, eliminate handling wherever possible. Ideally there should not be any handling at all!
2. Sequence the operations in logical manner so that handling is unidirectional and smooth.
3. Use gravity wherever possible as it results in conservation of power and fuel.
4. Standardise the handling equipments to the extent possible as it means interchangeable usage, better utilisation of handling equipments, and lesser spares holding.
5. Install a regular preventive maintenance programme for material handling equipments so that downtime is minimum.
6. In selection of handling equipments, criteria of versatility and adaptability must be the governing factor. This will ensure that investments in special purpose handling equipments are kept at a minimum.
7. Weight of unit load must be maximum so that each 'handling trip' is productive.
8. Work study aspects, such as elimination of unnecessary movements and combination of processes should be considered while installing a material handling system.
9. Non-productive operations in handling, such as slinging, loading, etc., should be kept at a minimum through appropriate design of handling equipment. Magnetic cranes for scrap movement and loading in furnaces combination of excavators and tippers for ores loading and unloading in mines are examples in this respect.
10. Location of stores should be as close as possible to the plant which uses the materials. This avoids handling and minimizing investment in material handling system.
11. Application of OR techniques such as queueing can be very effective in optimal utilisation of materials handling equipments.
12. A very important aspect in the design of a material handling system is the safety aspect. The system designed should be simple and safe to operate.
13. Avoid any wasteful movements-method study can be conducted for this purpose.
14. Ensure proper coordination through judicious selection of equipments and training of workmen.

### **3.8 RELATIONSHIP BETWEEN PLANT LAYOUT AND MATERIAL HANDLING**

There is a close relationship between plant layout and material handling. A good layout ensures minimum material handling and eliminates rehandling in the following ways:

1. Material movement does not add any value to the product so, the material handling should be kept at minimum though not avoid it. This is possible only through the systematic plant layout. Thus a good layout minimises handling.
2. The productive time of workers will go without production if they are required to travel long distance to get the material tools, etc. Thus a good layout ensures minimum travel

for workman thus enhancing the production time and eliminating the hunting time and travelling time.

3. Space is an important criterion. Plant layout integrates all the movements of men, material through a well designed layout with material handling system.
4. Good plant layout helps in building efficient material handling system. It helps to keep material handling shorter, faster and economical. A good layout reduces the material backtracking, unnecessary workmen movement ensuring effectiveness in manufacturing. Thus a good layout always ensures minimum material handling.

## EXERCISES

### Section A

1. Define material handling
2. Mention any four objectives of material handling.
3. Mention any four principles of material handling.
4. What do you mean by “Equipment Utilisation Ratio”?
5. Mention some of the fixed path equipments.
6. Mention some of the valuable path equipments.

### Section B

1. Explain the objectives of material handling.
2. Explain the principles of material handling.
3. How do you evaluate the material handling system?
4. What are the relationship between plant layout and material handling?

### Section C

1. Discuss the factors to be considered while selecting material handling equipment.
2. Discuss the different material handling equipments.
3. Discuss the guidelines for effective utilisation of material handling equipments.

### Skill Development

**FAST FOOD RESTAURANT VISIT:** Get the information for the following questions:

1. Material handling in the restaurant for production and services.
2. Type of material handling equipment used for production and services.
3. Utilisation of material handling equipment.

# 4

## MATERIALS MANAGEMENT

### CHAPTER OUTLINE

- |   |  |
|---|--|
| 4.1 <i>Introduction and Meaning</i>                   | 4.8 <i>Simplification</i>                    |
| 4.2 <i>Scope or Functions of Materials Management</i> | 4.9 <i>Value Analysis</i>                    |
| 4.3 <i>Material Planning and Control</i>              | 4.10 <i>Ergonomics (Human Engineering)</i>   |
| 4.4 <i>Purchasing</i>                                 | 4.11 <i>Just-in-Time (JIT) Manufacturing</i> |
| 4.5 <i>Stores Management</i>                          | • <i>Exercises</i>                           |
| 4.6 <i>Inventory Control or Management</i>            | • <i>Skill Development</i>                   |
| 4.7 <i>Standardization</i>                            | • <i>Caselet</i>                             |

### 4.1 INTRODUCTION AND MEANING

Materials management is a function, which aims for integrated approach towards the management of materials in an industrial undertaking. Its main objective is cost reduction and efficient handling of materials at all stages and in all sections of the undertaking. Its function includes several important aspects connected with material, such as, purchasing, storage, inventory control, material handling, standardisation etc.

### 4.2 SCOPE OR FUNCTIONS OF MATERIALS MANAGEMENT

Materials management is defined as “*the function responsible for the coordination of planning, sourcing, purchasing, moving, storing and controlling materials in an optimum manner so as to provide a pre-decided service to the customer at a minimum cost*”.

From the definition it is clear that the scope of materials management is vast. The functions of materials management can be categorized in the following ways: (as shown in Fig. 4.1.)

1. Material Planning and Control



2. Purchasing
3. Stores Management
4. Inventory Control or Management
5. Standardisation
6. Simplification
7. Value Analysis
8. Ergonomics
9. Just-in-Time (JIT)

All the above mentioned functions of materials management has been discussed in detail in this chapter.

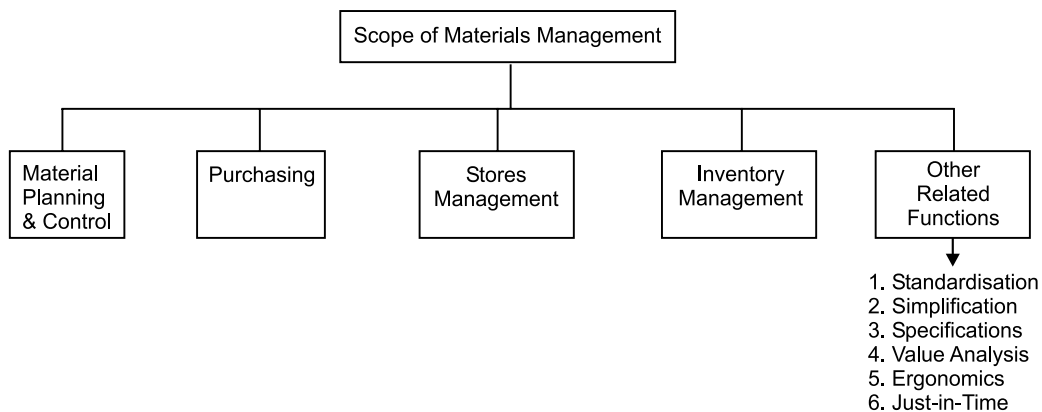

**Fig. 4.1** *Scope of materials management*

1. **Materials planning and control:** Based on the sales forecast and production plans, the materials planning and control is done. This involves estimating the individual requirements of parts, preparing materials budget, forecasting the levels of inventories, scheduling the orders and monitoring the performance in relation to production and sales.

2. **Purchasing:** This includes selection of sources of supply finalization in terms of purchase, placement of purchase orders, follow-up, maintenance of smooth relations with suppliers, approval of payments to suppliers, evaluating and rating suppliers.

3. **Stores management or management:** This involves physical control of materials, preservation of stores, minimization of obsolescence and damage through timely disposal and efficient handling, maintenance of stores records, proper location and stocking. A store is also responsible for the physical verification of stocks and reconciling them with book figures. A store plays a vital role in the operations of a company.

4. **Inventory control or management:** Inventory generally refers to the materials in stock. It is also called the idle resource of an enterprise. Inventories represent those items, which are either stocked for sale or they are in the process of manufacturing or they are in the form of

materials, which are yet to be utilized. The interval between receiving the purchased parts and transforming them into final products varies from industries to industries depending upon the cycle time of manufacture. It is, therefore, necessary to hold inventories of various kinds to act as a buffer between supply and demand for efficient operation of the system. Thus, an effective control on inventory is a must for smooth and efficient running of the production cycle with least interruptions.

#### 5. Other related activities

##### (a) 3S

(i) *Standardization*: Standardization means producing maximum variety of products from the minimum variety of materials, parts, tools and processes. It is the process of establishing standards or units of measure by which extent, quality, quantity, value, performance etc. may be compared and measured.

(ii) *Simplification*: The concept of simplification is closely related to standardization. Simplification is the process of reducing the variety of products manufactured. Simplification is concerned with the reduction of product range, assemblies, parts, materials and design.

(iii) *Specifications*: It refers to a precise statement that formulizes the requirements of the customer. It may relate to a product, process or a service.

**Example:** Specifications of an axle block are Inside Dia. =  $2 \pm 0.1$  cm, Outside Dia. =  $4 \pm 0.2$  cm and Length =  $10 \pm 0.5$  cm.

(b) *Value analysis*: Value analysis is concerned with the costs added due to inefficient or unnecessary specifications and features. It makes its contribution in the last stage of product cycle, namely, the maturity stage. At this stage research and development no longer make positive contributions in terms of improving the efficiency of the functions of the product or adding new functions to it.

(c) *Ergonomics (Human Engineering)*: The human factors or human engineering is concerned with man-machine system. Ergonomics is “the design of human tasks, man-machine system, and effective accomplishment of the job, including displays for presenting information to human sensors, controls for human operations and complex man-machine systems.” Each of the above functions are dealt in detail.

### 4.3 MATERIAL PLANNING AND CONTROL

Material planning is a scientific technique of determining in advance the requirements of raw materials, ancillary parts and components, spares etc. as directed by the production programme. It is a sub-system in the overall planning activity. There are many factors, which influence the activity of material planning. These factors can be classified as macro and micro systems.

1. *Macro factors*: Some of the micro factors which affect material planning, are price trends, business cycles Govt. import policy etc.
2. *Micro factors*: Some of the micro factors that affect material planning are plant capacity utilization, rejection rates, lead times, inventory levels, working capital, delegation of powers and communication.

### 4.3.1 Techniques of Material Planning

One of the techniques of material planning is bill of material explosion. Material planning through bill of material explosion is shown below in Fig. 4.2.

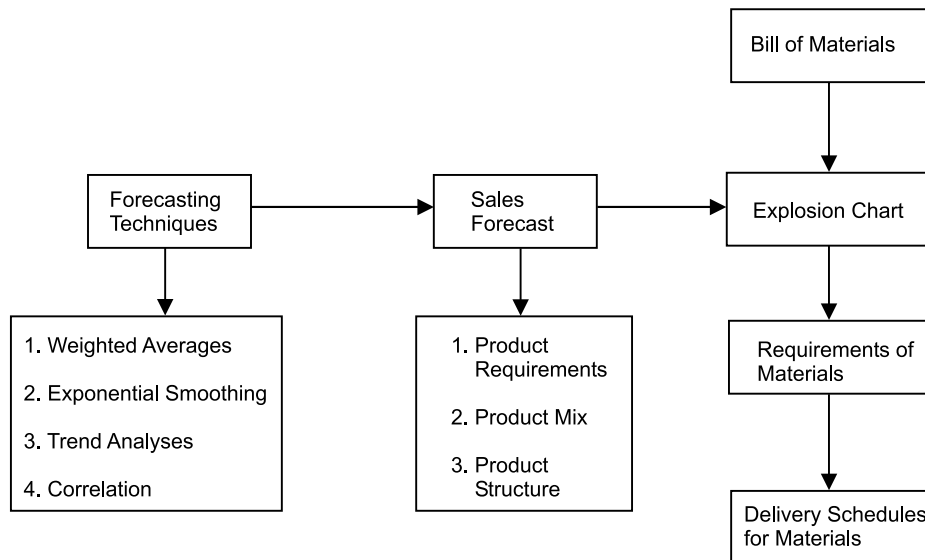

**Fig. 4.2** Material planning

The basis for material planning is the forecast demand for the end products. Forecasting techniques such as weighted average method, exponential smoothing and time series models are used for the same. Once the demand forecast is made, it is possible to go through the exercise of material planning. Bill of materials is a document which shows list of materials required, unit consumption location code for a given product. An explosive chart is a series of bill of material grouped in a matrix form so that combined requirements for different components can be done. Requirements of various materials are arrived at from the demand forecast, using bill of materials, through explosion charts. Thus material requirement plan will lead to the development of delivery schedule of the materials and purchasing of those material requirements.

## 4.4 PURCHASING

Purchasing is an important function of materials management. In any industry purchase means buying of equipments, materials, tools, parts etc. required for industry. The importance of the purchase function varies with nature and size of industry. In small industry, this function is performed by works manager and in large manufacturing concern; this function is done by a separate department. The moment a buyer places an order he commits a substantial portion of the finance of the corporation which affects the working capital and cash flow position. He is a highly responsible person who meets various salesmen and thus can be considered to have been contributing to the public relations efforts of the company. Thus, the buyer can make or mar the company's image by his excellent or poor relations with the vendors.

#### 4.4.1 Objectives of Purchasing

The basic objective of the purchasing function is to ensure continuity of supply of raw materials, sub-contracted items and spare parts and to reduce the ultimate cost of the finished goods. In other words, the objective is not only to procure the raw materials at the lowest price but to reduce the cost of the final product.

The objectives of the purchasing department can be outlined as under:

1. **To avail the materials, suppliers and equipments at the minimum possible costs:** These are the inputs in the manufacturing operations. The minimization of the input cost increases the productivity and resultantly the profitability of the operations.
2. **To ensure the continuous flow of production** through continuous supply of raw materials, components, tools etc. with repair and maintenance service.
3. **To increase the asset turnover:** The investment in the inventories should be kept minimum in relation to the volume of sales. This will increase the turnover of the assets and thus the profitability of the company.
4. **To develop an alternative source of supply:** Exploration of alternative sources of supply of materials increases the bargaining ability of the buyer, minimisation of cost of materials and increases the ability to meet the emergencies.
5. **To establish and maintain the good relations with the suppliers:** Maintenance of good relations with the supplier helps in evolving a favourable image in the business circles. Such relations are beneficial to the buyer in terms of changing the reasonable price, preferential allocation of material in case of material shortages, etc.
6. **To achieve maximum integration with other department of the company:** The purchase function is related with **production department** for specifications and flow of material, **engineering department** for the purchase of tools, equipments and machines, **marketing department** for the forecasts of sales and its impact on procurement of materials, **financial department** for the purpose of maintaining levels of materials and estimating the working capital required, **personnel department** for the purpose of manning and developing the personnel of purchase department and maintaining good vendor relationship.
7. **To train and develop the personnel:** Purchasing department is manned with varied types of personnel. The company should try to build the imaginative employee force through training and development.
8. **Efficient record keeping and management reporting:** Paper processing is inherent in the purchase function. Such paper processing should be standardised so that record keeping can be facilitated. Periodic reporting to the management about the purchase activities justifies the independent existence of the department.

#### 4.4.2 Parameters of Purchasing

The success of any manufacturing activity is largely dependent on the procurement of raw materials of right quality, in the right quantities, from right source, at the right time and at right

price popularly known as **ten 'R's'** of the art of efficient purchasing. They are described as the basic principles of purchasing. There are other well known parameters such as right contractual terms, right material, right place, right mode of transportation and right attitude are also considered for purchasing.

### **1. RIGHT PRICE**

It is the primary concern of any manufacturing organization to get an item at the right price. But right price need not be the lowest price. It is very difficult to determine the right price; general guidance can be had from the cost structure of the product. The 'tender system' of buying is normally used in public sector organizations but the objective should be to identify the lowest 'responsible' bidder and not the lowest bidder. The technique of 'learning curve' also helps the purchase agent to determine the price of items with high labour content. The price can be kept low by proper planning and not by rush buying. Price negotiation also helps to determine the right prices.

### **2. RIGHT QUALITY**

Right quality implies that quality should be available, measurable and understandable as far as practicable. In order to determine the quality of a product sampling schemes will be useful. The right quality is determined by the cost of materials and the technical characteristics as suited to the specific requirements. The quality particulars are normally obtained from the indents. Since the objective of purchasing is to ensure continuity of supply to the user departments, the time at which the material is provided to the user department assumes great importance.

### **3. RIGHT TIME**

For determining the right time, the purchase manager should have lead time information for all products and analyse its components for reducing the same. Lead time is the total time elapsed between the recognition of the need of an item till the item arrives and is provided for use. This covers the entire duration of the materials cycle and consists of pre-contractual administrative lead time, manufacturing and transporting lead time and inspection lead time. Since the inventory increases with higher lead time, it is desirable to analyse each component of the lead time so as to reduce the first and third components which are controllable. While determining the purchases, the buyer has to consider emergency situations like floods, strikes, etc. He should have 'contingency plans' when force major clauses become operative, for instance, the material is not available due to strike, lock-out, floods, and earthquakes.

### **4. RIGHT SOURCE**

The source from which the material is procured should be dependable and capable of supplying items of uniform quality. The buyer has to decide which item should be directly obtained from the manufacturer. Source selection, source development and vendor rating play an important role in buyer-seller relationships. In emergencies, open market purchases and bazaar purchases are restored to.

### **5. RIGHT QUANTITY**

The right quantity is the most important parameter in buying. Concepts, such as, economic order quantity, economic purchase quantity, fixed period and fixed quantity systems, will serve as broad guidelines. But the buyer has to use his knowledge, experience and common sense to determine

the quantity after considering factors such as price structure, discounts, availability of the item, favourable reciprocal relations, and make or buy consideration.

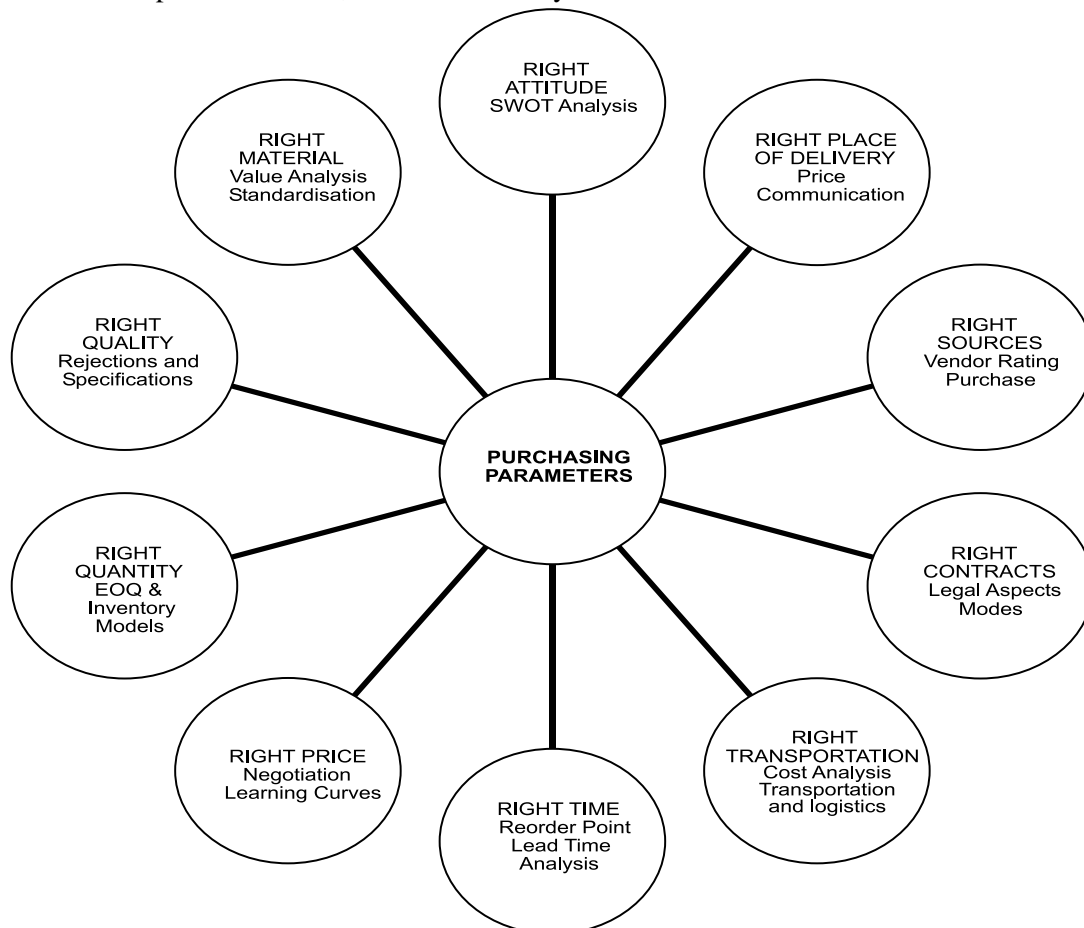

**Fig. 4.3** Purchase parameters

## 6. RIGHT ATTITUDE

Developing the right attitude, too, is necessary as one often comes across such statement: 'Purchasing knows the price of everything and value of nothing'; 'We buy price and not cost'; 'When will our order placers become purchase managers?'; 'Purchasing acts like a post box'. Therefore, purchasing should keep 'progress' as its key activity and should be future-oriented. The purchase manager should be innovative and his long-term objective should be to minimise the cost of the ultimate product. He will be able to achieve this if he aims himself with techniques, such as, value analysis, materials intelligence, purchases research, SWOT analysis, purchase budget lead time analysis, etc.

## 7. RIGHT CONTRACTS

The buyer has to adopt separate policies and procedures for capital and consumer items. He should be able to distinguish between indigenous and international purchasing procedures. He should be aware of the legal and contractual aspects in international practices.

**8. RIGHT MATERIAL**

Right type of material required for the production is an important parameter in purchasing. Techniques, such as, value analysis will enable the buyer to locate the right material.

**9. RIGHT TRANSPORTATION**

Right mode of transportation have to be identified as this forms a critical segment in the cost profile of an item. It is an established fact that the cost of the shipping of ore, gravel, sand, etc., is normally more than the cost of the item itself.

**10. RIGHT PLACE OF DELIVERY**

Specifying the right place of delivery, like head office or works, would often minimize the handling and transportation cost.

**4.4.3 Purchasing Procedure**

The procedure describes the sequence of steps leading to the completion of an identified specific task. The purchasing procedure comprises the following steps as indicated in Fig. 4.4.

**1. RECOGNITION OF THE NEED**

The initiation of procedure starts with the recognition of the need by the needy section. The demand is lodged with the purchase department in the prescribed Purchase Requisition Form forwarded by the authorised person either directly or through the Stores Department. The purchase requisition clearly specifies the details, such as, specification of materials, quality and quantity, suggested supplier, etc. Generally, the low value sundries and items of common use are purchased for stock while costlier and special items are purchased according the production programmes. Generally, the corporate level executives are authorized signatories to such demands. Such purchases are approved by the Board of Directors. The reference of the approval is made on requisition and a copy of the requisition is sent to the secretary for the purpose of overall planning and budgeting.

**2. THE SELECTION OF THE SUPPLIER**

The process of selection of supplier involves two basic aspects: searching for all possible sources and short listing out of the identified sources. The complete information about the supplier is available from various sources, such as, trade directories, advertisement in trade journals, direct mailing by the suppliers, interview with suppliers, salesmen, suggestions from business associates, visit to trade fair, participation in industries convention, etc. Identification of more and more sources helps in selecting better and economical supplier. It should be noted that the low bidder is not always the best bidder. When everything except price is equal, the low bidder will be selected. The important considerations in the selection are the price, ability to supply the required quantity, maintenance of quality standards, financial standing etc. It should be noted that it is not necessary to go for this process for all types of purchases. For the repetitive orders and for the purchases of low-value, small lot items, generally the previous suppliers with good records are preferred.

**3. PLACING THE ORDER**

Once the supplier is selected the next step is to place the purchase order. Purchase order is a letter sent to the supplier asking to supply the said material. At least six copies of purchase order

are prepared by the purchase section and each copy is separately signed by the purchase officer. Out these copies, one copy each is sent to store-keeper, supplier, accounts section, inspection department and to the department placing the requisition and one copy is retained by the purchase department for record.

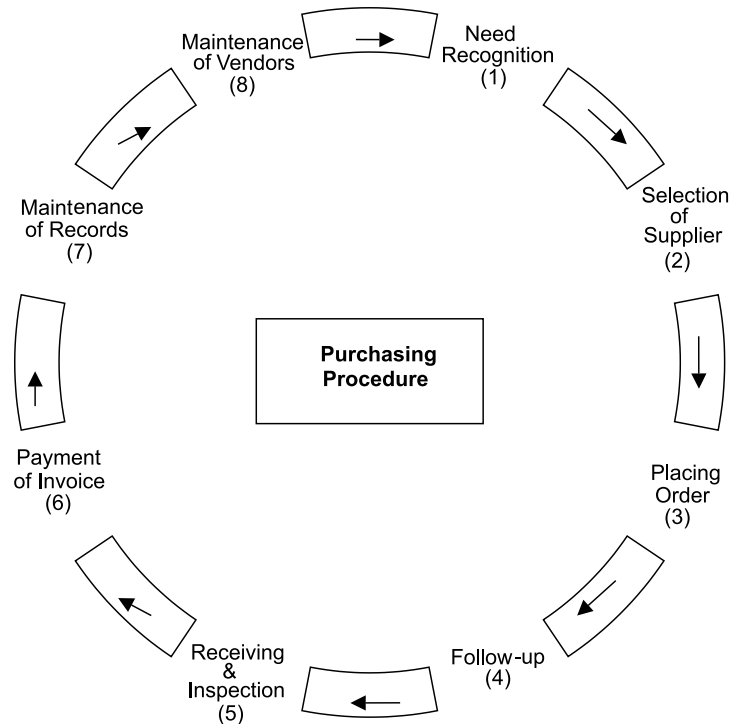

Fig. 4.4 Purchasing procedure

#### 4. FOLLOW-UP OF THE ORDER

Follow-up procedure should be employed wherever the costs and risks resulting from the delayed deliveries of materials are greater than the cost of follow-up procedure, the follow-up procedure tries to see that the purchase order is confirmed by the supplier and the delivery is promised. It is also necessary to review the outstanding orders at regular intervals and to communicate with the supplier in case of need. Generally, a routine urge is made to the supplier by sending a printed post card or a circular letter asking him to confirm that the delivery is on the way or will be made as per agreement. In absence of any reply or unsatisfactory reply, the supplier may be contact through personal letter, phone, telegram and/or even personal visit.

#### 5. RECEIVING AND INSPECTION OF THE MATERIALS

The receiving department receives the materials supplied by the vendor. The quantity are verified and tallied with the purchase order. The receipt of the materials is recorded on the specially designed receiving slips or forms which also specify the name of the vendor and the purchase order number. It also records any discrepancy, damaged condition of the consignment or inferiority of the materials. The purchase department is informed immediately about the receipt of the materials. Usually a copy of the receiving slip is sent to the purchase department.



**6. PAYMENT OF THE INVOICE**

When the goods are received in satisfactory condition, the invoice is checked before it is approved for the payment. The invoice is checked to see that the goods were duly authorised to purchase, they were properly ordered, they are priced as per the agreed terms, the quantity and quality confirm to the order, the calculations are arithmetically correct etc.

**7. MAINTENANCE OF THE RECORDS**

Maintenance of the records is an important part and parcel of the efficient purchase function. In the industrial firms, most of the purchases are repeat orders and hence the past records serve as a good guide for the future action. They are very useful for deciding the timings of the purchases and in selecting the best source of the supply.

**8. MAINTENANCE OF VENDOR RELATIONS**

The quantum and frequency of the transactions with the same key suppliers provide a platform for the purchase department to establish and maintain good relations with them. Good relations develop mutual trust and confidence in the course of the time which is beneficial to both the parties. The efficiency of the purchase department can be measured by the amount of the goodwill it has with its suppliers.

**4.4.4 Selection of Suppliers**

Selection of the right supplier is the responsibility of the purchase department. It can contribute substantially to the fundamental objectives of the business enterprise. Different strategies are required for acquiring different types of materials. The selection of supplier for standardised products will differ from non-standardised products. Following factors are considered for the selection of suppliers:

**A. SOURCES OF SUPPLIER**

The best buying is possible only when the decision maker is familiar with all possible sources of supply and their respective terms and conditions. The purchase department should try to locate the appropriate sources of the supplier of various types of materials. This is known as 'survey stage'. A survey of the following will help in developing the possible sources of supply:

1. Specialised trade directories.
2. Assistance of professional bodies or consultants.
3. The buyer's guide or purchase handbook.
4. The manufacturer's or distributor's catalogue.
5. Advertisements in dailies.
6. Advertisement in specialised trade journals.
7. Trade fair exhibitions.

**B. DEVELOPMENT OF APPROVED LIST OF SUPPLIERS**

The survey stage highlights the existence of the source. A business inquiry is made with the appropriate supplier. It is known as 'Inquiry Stage'. Here a short listing is made out of the given sources of suppliers in terms of production facilities and capacity, financial standing, product

quality, possibility of timely supply, technical competence, manufacturing efficiency, general business policies followed, standing in the industry, competitive attitude, and interest in buying orders etc.

### **C. EVALUATION AND SELECTION OF THE SUPPLIER**

The purchase policy and procedure differ according to the type of items to be purchased. Hence, evolution and selection of the supplier differ accordingly. In the 'purchasing handbook' edited by Aljian, it has been described that the following variables to be considered while evaluating the quotations of the suppliers:

#### **1. Cost Factors**

Price, transportation cost, installation cost if any, tooling and other operations cost, incidence of sales tax and excise duty, terms of payment and cash discount are considered in cost factor.

#### **2. Delivery**

Routing and F.O.B. terms are important in determining the point at which the title to the goods passes from vendor to the buyer and the responsibility for the payment of the payment charges.

#### **3. Design and Specification Factors**

Specification compliance, specification deviations, specification advantages, important dimensions and weights are considered in line with the demonstration of sample, experience of other users, after sale services etc.

#### **4. Legal Factors**

Legal factors include warranty, cancellation provision, patent protection, public liability, federal laws and reputation compliance.

#### **5. Vendor Rating**

The evaluation of supplier or vendor rating provides valuable information which help in improving the quality of the decision. In the vendor rating three basic aspects are considered namely quality, service and price. How much weight should be given to each of these factors is a matter of judgment and is decided according to the specific need of the organization. Quality would be the main consideration in the manufacturing of the electrical equipments while price would be the prime consideration in the product having a tense competitive market and for a company procuring its requirements under the blanket contract with agreed price, the supplier rating would be done on the basis of two variables namely quality and delivery.

The Development Project Committee of the National Association of Purchasing Agents (U.S.A.) has suggested following methods for evaluating the performance of past suppliers.

1. **The categorical plan:** Under this method the members of the buying staff related with the supplier like receiving section, quality control department, manufacturing department etc., are required to assess the performance of each supplier. The rating sheets are provided with the record of the supplier, their product and the list of factors for the evaluation purposes. The members of the buying staff are required to assign the plus or minus notations against each factor. The periodic meetings, usually at the interval of one month, are held by senior man of the buying staff to consider the individual rating of each section. The consolidation of the individual rating is done on the basis of the net plus value and accordingly, the suppliers are assigned the categories such as 'preferred', 'neutral' or 'unsatisfactory'. Such ratings are used for the future guidance.

This is a very simple and inexpensive method. However, it is not precise. Its quality heavily depends on the experience and ability of the buyer to judge the situation. As compared to other methods, the degree of subjective judgment is very high as rating is based on personal whim and the vague impressions of the buyer. As the quantitative data supported by the profits do not exist, it is not possible to institute any corrective action with the vendor. The rating is done on the basis of memory, and thus it becomes only a routine exercise without any critical analysis.

2. **The weighted-point method:** The weighted-point method provides the quantitative data for each factor of evaluation. The weights are assigned to each factor of evaluation according to the need of the organization, e.g., a company decides the three factors to be considered—quality, price and timely delivery. It assigns the relative weight to each of these factors as under:

<b>Quality</b>	.....	50 points
<b>Price</b>	.....	30 points
<b>Timely delivery</b>	.....	20 points

The evaluation of each supplier is made in accordance with the aforesaid factors and weights and the composite weighted-points are ascertained for each suppliers—A, B and C—are rated under this method. First of all the specific rating under each factor will be made and then the consolidation of all the factors will be made for the purpose of judgment.

**Quality rating:** Percentage of quantity accepted among the total quantity is called quality rating. In other words, the quality of the materials is judged on the basis of the degree of acceptance and rejections. For the purpose of comparison, the percentage degree of acceptance will be calculated in relation to the total lots received. **Price rating** is done on the basis of net price charged by the supplier. **Timely delivery** rating will be done comparing with the average delivery schedule of the supplier.

3. **The cost-ratio plan:** Under this method, the vendor rating is done on the basis of various costs incurred for procuring the materials from various suppliers. The cost-ratios are ascertained delivery etc. The cost-ratios are ascertained for the different rating variables such as quality, price, timely delivery etc. The cost-ratio is calculated in percentage on the basis of total individual cost and total value of purchases. At the end, all such cost-ratios will be adjusted with the quoted price per unit. The plus cost-ratio will increase the unit price while the minus cost-ratio will decrease the unit price. The net adjusted unit price will indicate the vendor rating. The vendor with the lowest net adjusted unit price will be the best supplier and so on. Certain quality costs can be inspection cost, cost of defectives, reworking costs and manufacturing losses on rejected items etc. Certain delivery costs can be postage and telegrams, telephones and extra cost for quick delivery etc.

**VENDER RATING ILLUSTRATIONS**

**ILLUSTRATION 1:** *The following information is available on 3 vendors: A, B and C. Using the data below, determine the best source of supply under weighed-point method and substantiate your solution.*

*Vendor A: Delivered '56' lots, '3' were rejected, '2' were not according to the schedule.  
Vendor B: Supplied '38' lots, '2' were rejected, '3' were late.*

Vendor C: Finished '42' lots, '4' were defective, '5' were delayed deliveries.  
Give 40 for quality and 30 weightage for service.

**SOLUTION: Formula:**

$$\text{Quality performance (weightage 40\%)} = \frac{\text{Quality accepted}}{\text{Total quantity supplied}} \times 40$$

**Delivery performance:**

X Adherence to time schedule (weightage 30%)

$$= \frac{\text{No. of delivery made on the scheduled date}}{\text{Total no. of scheduled deliveries}} \times 30$$

Y Adherence to quantity schedule (weightage 30%)

$$= \frac{\text{No. of correct lot size deliveries}}{\text{Total no. of scheduled deliveries}} \times 30$$

Total vendor rating = X + Y

$$\text{Vendor A} = \frac{53}{56} \times 40 + \frac{54}{56} \times 30 = 66.78$$

$$\text{Vendor B} = \frac{36}{38} \times 40 + \frac{35}{38} \times 30 = 65.52$$

$$\text{Vendor C} = \frac{38}{42} \times 40 + \frac{37}{42} \times 30 = 62.62$$

Vendor 'A' is selected with the best rating.

**ILLUSTRATION 2:** The following information is available from the record of the incoming material department of ABC Co. Ltd.

Vendor code	No. of lots submitted	No. of list accepted	Proportion defectives in lots	Unit price in Rs.	Fraction of delivery commitment
A	15	12	0.08	15.00	0.94
B	10	9	0.12	19.00	0.98
C	1	1	–	21.00	0.90

The factor weightage for quality, delivery and price are 40%, 35% and 25% as per the decision of the *mar.* Rank the performance of the vendors on the QDP basis interpret the result.

**SOLUTION: Formula:**

Total vendor rating = Quality performance + Delivery performance rating + Price rating

$$\text{Vendor A} = \frac{12}{15} \times 40 + 0.94 \times 35 + \frac{15}{15} \times 25 = 89.90$$

$$\text{Vendor B} = \frac{9}{10} \times 40 + 0.98 \times 35 + \frac{15}{19} \times 25 = 90.036$$

$$\text{Vendor C} = 1 \times 40 + 0.90 \times 35 + \frac{15}{21} \times 25 = 89.357$$

**Formal mode:**

$$\begin{aligned}
 &= \frac{\text{No. of lots accepted}}{\text{No. of lots submitted}} \times (\text{weightage for quality}) \\
 &+ \frac{\text{No. of accepted lots}}{\text{No. of lots submitted with time}} \times (\text{weightage for delivery}) \\
 &+ \frac{\text{Lowest price}}{\text{Price of lot}} \times (\text{weightage for price})
 \end{aligned}$$

Vendor B is selected with higher rating.

#### 4.4.5 Special Purchasing Systems

The following are some of the important purchasing systems:

##### 1. FORWARD BUYING

Forward buying or committing an organization far into the future, usually for a year. Depending upon the availability of the item, the financial policies, the economic order quantity, the quantitative discounts, and the staggered delivery, the future commitment is decided. This type of forward buying is different from speculative buying where the motive is to make capital out of the price changes, by selling the purchased items. Manufacturing organizations normally do not indulge in such buying. However, a few organizations do 'Hedge', particularly in the commodity market by selling or buying contracts.

##### 2. TENDER BUYING

In public, all semblance of favouritism, personal preferences should be avoided. As such, it is common for government departments and public sector undertakings to purchase through tenders. Private sector organizations adopt tender buying if the value of purchases is more than the prescribed limits as Rs. 50000 or Rs. 100000. The steps involved are to establish a bidders' list, solicit bids by comparing quotations and place the order with the lowest bidder. However, care has to be taken that the lowest bidder is responsible party and is capable of meeting the delivery schedule and quality requirements. Open tender system or advertisement in newspapers is common in public sector organizations. As advertising bids is costly and time consuming, most private sector organizations solicit tenders only from the renowned suppliers capable of supplying the materials.

##### 3. BLANKET ORDER SYSTEM

This system minimizes the administrative expenses and is useful for 'C' type items. It is an agreement to provide a required quantity of specified items, over a period of time, usually for one year, at an agreed price. Deliveries are made depending upon the buyer's needs. The system relieves the buyers from routine work, giving him more time for focusing attention on high value items. It requires fewer purchase orders and thus reduces clerical work. It often achieves lower prices through quantity discounts by grouping the requirements. The supplier, under the system maintains adequate inventory to meet the blanket orders.

##### 4. ZERO STOCK

Some firms try to operate on the basis of zero stock and the supplier holds the stock for these firms. Usually, the firms of the buyer and seller are close to each other so that the raw materials

of one is the finished products of another. Alternatively, the system could work well if the seller holds the inventory and if the two parties work in close coordination. However, the price per item in this system will be slightly higher as the supplier will include the inventory carrying cost in the price. In this system, the buyer need not lock up the capital and so the purchasing routine is reduced. This is also significantly reduces obsolescence of inventory, lead time and clerical efforts in paper work. Thus, the seller can devote his marketing efforts to other customers and production scheduling becomes easy.

### **5. RATE CONTRACT**

The system of rate contract is prevalent in public sector organizations and government departments. It is common for the suppliers to advertise that they are on 'rate contract' for the specific period. After negotiations, the seller and the buyer agree to the rates of items. Application of rate contract has helped many organizations to cut down the internal administrative lead time as individual firms need to go through the central purchasing departments and can place orders directly with the suppliers. However, suppliers always demand higher prices for prompt delivery, as rate difficulty has been avoided by ensuring the delivery of a minimum quantity at the agreed rates. This procedure of fixing a minimum quantity is called the running contract and is being practised by the railways. The buyer also has an option of increasing the quantity by 25% more than the agreed quantity under this procedure.

### **6. RECIPROCITY**

Reciprocal buying means purchasing from one's customers in preference to others. It is based on the principle "if you kill my cat, I will kill your dog", and "Do unto your customers as you would have them do unto you". Other things, like soundness from the ethics and economics point of view being equal, the principles of reciprocity can be practiced. However, a purchasing executive should not indulge in reciprocity on his initiative when the terms and conditions are not equal with other suppliers. It is often sound that less efficient manufacturers and distributors gain by reciprocity what they are unable to gain by price and quality. Since this tends to discourage competition and might lead to higher process and fewer suppliers, reciprocity should be practised on a selective basis.

### **7. SYSTEMS CONTRACT**

This is a procedure intended to help the buyer and the sellers to reduce administrative expenses and at the same time ensure suitable controls. In this system, the original indent, duly approved by competent authorities, is shipped back with the items and avoids the usual documents like purchase orders, materials requisitions, expediting letters and acknowledgements, delivery period price and invoicing procedure. Carborandum company in the US claims drastic reduction in inventory and elimination of 40000 purchase orders by adopting the system contracting procedure. It is suitable for low unit price items with high consumption.

## **4.5**

### **STORES MANAGEMENT**

Stores play a vital role in the operations of company. It is in direct touch with the user departments in its day-to-day activities. The most important purpose served by the stores is to provide

uninterrupted service to the manufacturing divisions. Further, stores are often equated directly with money, as money is locked up in the stores.

### **FUNCTIONS OF STORES**

The functions of stores can be classified as follows:

1. To receive raw materials, components, tools, equipment's and other items and account for them.
2. To provide adequate and proper storage and preservation to the various items.
3. To meet the demands of the consuming departments by proper issues and account for the consumption.
4. To minimise obsolescence, surplus and scrap through proper codification, preservation and handling.
5. To highlight stock accumulation, discrepancies and abnormal consumption and effect control measures.
6. To ensure good house keeping so that material handling, material preservation, stocking, receipt and issue can be done adequately.
7. To assist in verification and provide supporting information for effective purchase action.

#### **4.5.1 Codification**

It is one of the functions of stores management. Codification is a process of representing each item by a number, the digit of which indicates the group, the sub-group, the type and the dimension of the item. Many organizations in the public and private sectors, railways have their own system of codification, varying from eight to thirteen digits. The first two digits represents the major groups, such as raw materials, spare parts, sub-contracted items, hardware items, packing material, tools, oil, stationery etc. The next two digits indicate the sub-groups, such as, ferrous, non-ferrous etc. Dimensional characteristics of length, width, head diameter etc. constitute further three digits and the last digit is reserved for minor variations.

Whatever may be the basis, each code should uniquely represent one item. It should be simple and capable of being understood by all. Codification should be compact, concise, consistent and flexible enough to accommodate new items. The groupings should be logical, holding similar parts near to one another. Each digit must be significant enough to represent some characteristic of the item.

#### **Objectives of Codification**

The objectives of a rationalized material coding system are:

1. Bringing all items together.
2. To enable putting up of any future item in its proper place.
3. To classify an item according to its characteristics.
4. To give an unique code number to each item to avoid duplication and ambiguity.
5. To reveal excessive variety and promote standardization and variety reduction.
6. To establish a common language for the identification of an item.

7. To fix essential parameters for specifying an item.
8. To specify item as per national and international standards.
9. To enable data processing and analysis.

### Advantages of Codification

As a result of rationalized codification, many firms have reduced the number of items. It enables systematic grouping of similar items and avoids confusion caused by long description of items since standardization of names is achieved through codification, it serves as the starting point of simplification and standardization. It helps in avoiding duplication of items and results in the minimisation of the number of items, leading to accurate record. Codification enables easy recognition of an item in stores, thereby reducing clerical efforts to the minimum. If items are coded according to the sources, it is possible to bulk the items while ordering. To maximise the aforesaid advantages, it is necessary to develop the codes as concerned, namely, personnel from design, production, engineering, inspection, maintenance and materials.

## 4.6 INVENTORY CONTROL OR MANAGEMENT

### 4.6.1 Meaning of Inventory

Inventory generally refers to the materials in stock. It is also called the idle resource of an enterprise. Inventories represent those items which are either stocked for sale or they are in the process of manufacturing or they are in the form of materials, which are yet to be utilised. The interval between receiving the purchased parts and transforming them into final products varies from industries to industries depending upon the cycle time of manufacture. It is, therefore, necessary to hold inventories of various kinds to act as a buffer between supply and demand for efficient operation of the system. Thus, an effective control on inventory is a must for smooth and efficient running of the production cycle with least interruptions.

### 4.6.2 Reasons for Keeping Inventories

1. **To stabilise production:** The demand for an item fluctuates because of the number of factors, *e.g.*, seasonality, production schedule etc. The inventories (raw materials and components) should be made available to the production as per the demand failing which results in stock out and the production stoppage takes place for want of materials. Hence, the inventory is kept to take care of this fluctuation so that the production is smooth.

2. **To take advantage of price discounts:** Usually the manufacturers offer discount for bulk buying and to gain this price advantage the materials are bought in bulk even though it is not required immediately. Thus, inventory is maintained to gain economy in purchasing.

3. **To meet the demand during the replenishment period:** The lead time for procurement of materials depends upon many factors like location of the source, demand supply condition, etc. So inventory is maintained to meet the demand during the procurement (replenishment) period.

4. **To prevent loss of orders (sales):** In this competitive scenario, one has to meet the delivery schedules at 100 per cent service level, means they cannot afford to miss the delivery schedule which may result in loss of sales. To avoid the organizations have to maintain inventory.



5. **To keep pace with changing market conditions:** The organizations have to anticipate the changing market sentiments and they have to stock materials in anticipation of non-availability of materials or sudden increase in prices.

6. Sometimes the organizations have to stock materials due to other reasons like suppliers minimum quantity condition, seasonal availability of materials or sudden increase in prices.

#### 4.6.3 Meaning of Inventory Control

Inventory control is a planned approach of determining what to order, when to order and how much to order and how much to stock so that costs associated with buying and storing are optimal without interrupting production and sales. Inventory control basically deals with two problems: (i) When should an order be placed? (Order level), and (ii) How much should be ordered? (Order quantity).

These questions are answered by the use of inventory models. The scientific inventory control system strikes the balance between the loss due to non-availability of an item and cost of carrying the stock of an item. Scientific inventory control aims at maintaining optimum level of stock of goods required by the company at minimum cost to the company.

#### 4.6.4 Objectives of Inventory Control

1. To ensure adequate supply of products to customer and avoid shortages as far as possible.
2. To make sure that the financial investment in inventories is minimum (*i.e.*, to see that the working capital is blocked to the minimum possible extent).
3. Efficient purchasing, storing, consumption and accounting for materials is an important objective.
4. To maintain timely record of inventories of all the items and to maintain the stock within the desired limits.
5. To ensure timely action for replenishment.
6. To provide a reserve stock for variations in lead times of delivery of materials.
7. To provide a scientific base for both short-term and long-term planning of materials.

#### 4.6.5 Benefits of Inventory Control

It is an established fact that through the practice of scientific inventory control, following are the benefits of inventory control:

1. Improvement in customer's relationship because of the timely delivery of goods and service.
2. Smooth and uninterrupted production and, hence, no stock out.
3. Efficient utilisation of working capital. Helps in minimising loss due to deterioration, obsolescence damage and pilferage.
4. Economy in purchasing.
5. Eliminates the possibility of duplicate ordering.

**4.6.6 Techniques of Inventory Control**

In any organization, depending on the type of business, inventory is maintained. When the number of items in inventory is large and then large amount of money is needed to create such inventory, it becomes the concern of the management to have a proper control over its ordering, procurement, maintenance and consumption. The control can be for order quality and order frequency.

The different techniques of inventory control are: (1) ABC analysis, (2) HML analysis, (3) VED analysis, (4) FSN analysis, (5) SDE analysis, (6) GOLF analysis and (7) SOS analysis. The most widely used method of inventory control is known as ABC analysis. In this technique, the total inventory is categorised into three sub-heads and then proper exercise is exercised for each sub-heads.

1. **ABC analysis:** In this analysis, the classification of existing inventory is based on annual consumption and the annual value of the items. Hence we obtain the quantity of inventory item consumed during the year and multiply it by unit cost to obtain annual usage cost. The items are then arranged in the descending order of such annual usage cost. The analysis is carried out by drawing a graph based on the cumulative number of items and cumulative usage of consumption cost. Classification is done as follows:

**Table 4.1**

<i>Category</i>	<i>Percentage of items</i>	<i>Percentage of annual consumption value</i>
A	10–20	70–80
B	20–30	10–25
C	60–70	5–15

The classification of ABC analysis is shown by the graph given as follows (Fig. 4.5).

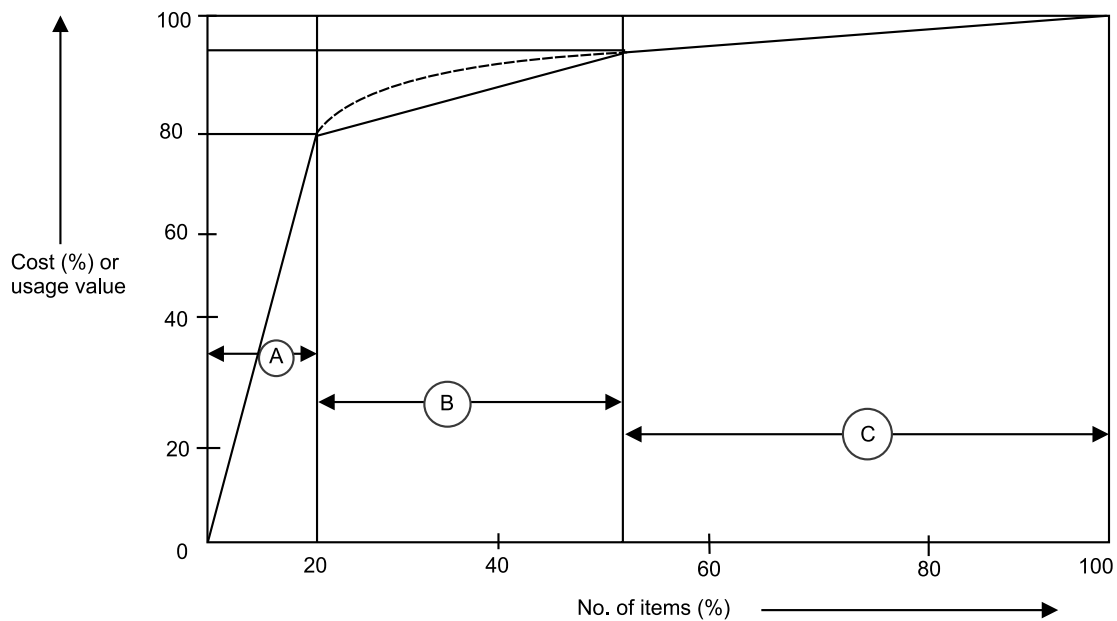

**Fig. 4.5 ABC classification**

Once ABC classification has been achieved, the policy control can be formulated as follows:

**A-Item:** Very tight control, the items being of high value. The control need be exercised at higher level of authority.

**B-Item:** Moderate control, the items being of moderate value. The control need be exercised at middle level of authority.

**C-Item:** The items being of low value, the control can be exercised at gross root level of authority, *i.e.*, by respective user department managers.

2. **HML analysis:** In this analysis, the classification of existing inventory is based on unit price of the items. They are classified as high price, medium price and low cost items.

3. **VED analysis:** In this analysis, the classification of existing inventory is based on criticality of the items. They are classified as vital, essential and desirable items. It is mainly used in spare parts inventory.

4. **FSN analysis:** In this analysis, the classification of existing inventory is based consumption of the items. They are classified as fast moving, slow moving and non-moving items.

5. **SDE analysis:** In this analysis, the classification of existing inventory is based on the items.

6. **GOLF analysis:** In this analysis, the classification of existing inventory is based sources of the items. They are classified as Government supply, ordinarily available, local availability and foreign source of supply items.

7. **SOS analysis:** In this analysis, the classification of existing inventory is based nature of supply of items. They are classified as seasonal and off-seasonal items.

For effective inventory control, combination of the techniques of ABC with VED or ABC with HML or VED with HML analysis is practically used.

#### 4.6.7 Inventory Model

##### ECONOMIC ORDER QUANTITY (EOQ)

Inventory models deal with idle resources like men, machines, money and materials. These models are concerned with two decisions: how much to order (purchase or produce) and when to order so as to minimize the total cost.

For the first decision—how much to order, there are two basic costs are considered namely, inventory carrying costs and the ordering or acquisition costs. As the quantity ordered is increased, the inventory carrying cost increases while the ordering cost decreases. The ‘order quantity’ means the quantity produced or procured during one production cycle. Economic order quantity is calculated by balancing the two costs. Economic Order Quantity (EOQ) is that size of order which minimizes total costs of carrying and cost of ordering.

*i.e.*, Minimum Total Cost occurs when Inventory Carrying Cost = Ordering Cost

Economic order quantity can be determined by two methods:

1. Tabulation method.
2. Algebraic method.

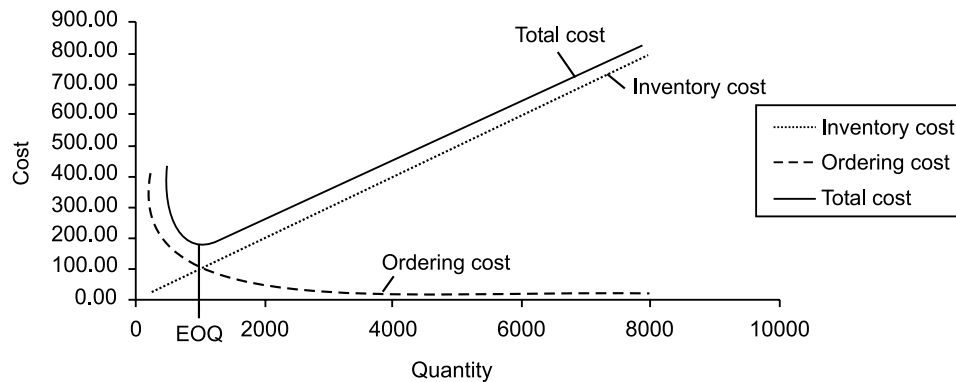

Fig. 4.6 Inventory cost curve

**1. Determination of EOQ by Tabulation (Trial & Error) Method**

This method involves the following steps:

1. Select the number of possible lot sizes to purchase.
2. Determine average inventory carrying cost for the lot purchased.
3. Determine the total ordering cost for the orders placed.
4. Determine the total cost for each lot size chosen which is the summation of inventory carrying cost and ordering cost.
5. Select the ordering quantity, which minimizes the total cost.

The data calculated in a tabular column can plotted showing the nature of total cost, inventory cost and ordering cost curve against the quantity ordered as in Fig. 4.6.

**ILLUSTRATION 3:** *The XYZ Ltd. carries a wide assortment of items for its customers. One of its popular items has annual demand of 8000 units. Ordering cost per order is found to be Rs. 12.5. The carrying cost of average inventory is 20% per year and the cost per unit is Re. 1.00. Determine the optimal economic quantity and make your recommendations.*

**SOLUTION:**

No. of orders/year (1)	Lot size (2)	Average inventory (3)	Carrying cost (4)	Ordering cost (5)	Total cost/year (6) = (4) + (5)
1	8000	4000	800.00	12.5	812.50
2	4000	2000	400.00	25	425.00
4	2000	1000	200.00	50	250.00
8	1000	500	100.00	100	200.00
12	666.667	333.333	66.67	150	216.67
16	500	250	50.00	200	250.00

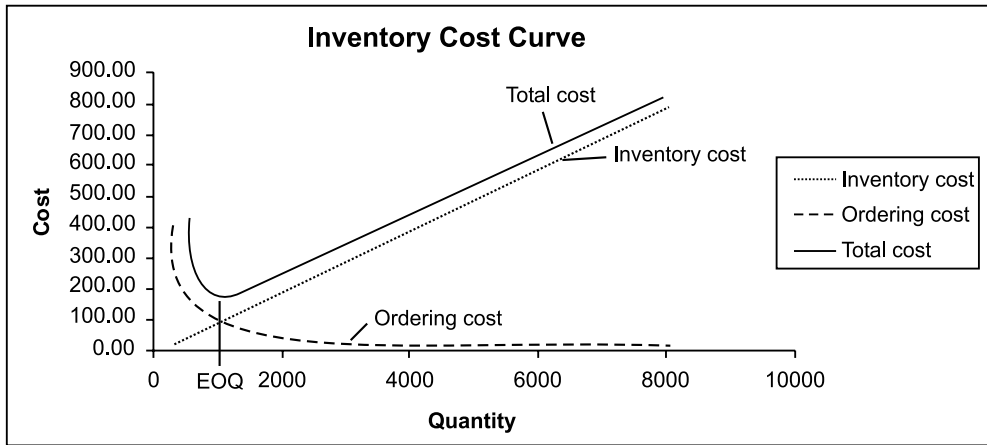

The table and the graph indicates that an order size of 1000 units will gives the lowest total cost among the different alternatives. It also shows that minimum total cost occurs when carrying cost is equal to ordering cost.

**2. Determination of EOQ by Analytical Method**

In order to derive an economic lot size formula following assumptions are made:

1. Demand is known and uniform.
2. Let D denotes the total number of units purchase/produced and Q denotes the lot size in each production run.
3. Shortages are not permitted, *i.e.*, as soon as the level of the inventory reaches zero, the inventory is replenished.
4. Production or supply of commodity is instantaneous.
5. Lead-time is zero.
6. Set-up cost per production run or procurement cost is  $C_3$ .
7. Inventory carrying cost is  $C_1 = CI$ , where C is the unit cost and I is called inventory carrying cost expressed as a percentage of the value of the average inventory.

This fundamental situation can be shown on an inventory-time diagram, (Fig. 4.7) with Q on the vertical axis and the time on the horizontal axis. The total time period (one year) is divided into *n* parts.

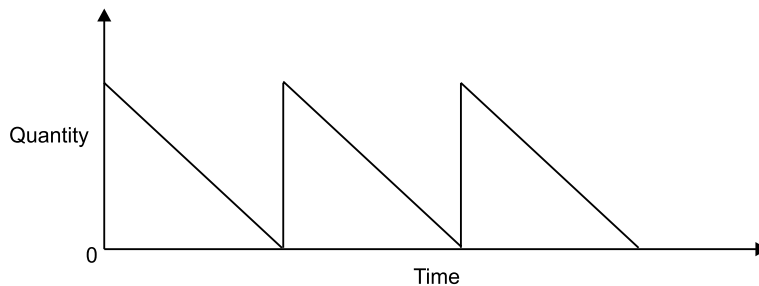

**Fig. 4.7**

The most economic point in terms of total inventory cost exists where,

$$\text{Inventory carrying cost} = \text{Annual ordering cost (set-up cost)}$$

$$\begin{aligned} \text{Average inventory} &= 1/2 (\text{maximum level} + \text{minimum level}) \\ &= (Q + 0)/2 = Q/2 \end{aligned}$$

$$\text{Total inventory carrying cost} = \text{Average inventory} \times \text{Inventory carrying cost per unit}$$

$$\text{i.e., Total inventory carrying cost} = Q/2 \times C_1 = QC_1/2 \quad \dots(1)$$

$$\text{Total annual ordering costs} = \text{Number of orders per year} \times \text{Ordering cost per order}$$

$$\text{i.e., Total annual ordering costs} = (D/Q) \times C_3 = (D/Q)C_3 \quad \dots(2)$$

Now, summing up the total inventory cost and the total ordering cost, we get the total inventory cost  $C(Q)$ .

$$\text{i.e., Total cost of production run} = \text{Total inventory carrying cost} \\ + \text{Total annual ordering costs}$$

$$C(Q) = QC_1/2 + (D/Q)C_3 \quad (\text{cost equation}) \quad \dots(3)$$

But, the total cost is minimum when the inventory carrying costs becomes equal to the total annual ordering costs. Therefore,

$$QC_1/2 = (D/Q)C_3$$

$$\text{or} \quad QC_1 = (2D/Q)C_3 \quad \text{or} \quad Q^2 = 2C_3D/C_1$$

$$\text{or} \quad Q = \sqrt{\frac{2C_3D}{C_1}}$$

$$\text{i.e., Optimal quantity (EOQ), } Q_0 = \sqrt{\frac{2C_3D}{C_1}} \quad \dots(4)$$

$$\text{Optimum number of orders, } (N_0) = \frac{D}{Q_0} \quad \dots(5)$$

$$\text{Optimum order interval, } (t_0) = \frac{365}{N_0} \text{ in days} = \frac{1}{N_0} \text{ in years or } (t_0) = \frac{Q_0}{D} \quad \dots(6)$$

$$\text{Average yearly cost (TC)} = \sqrt{2C_3DC_1} \quad \dots(7)$$

**ILLUSTRATION 4:** An oil engine manufacturer purchases lubricants at the rate of Rs. 42 per piece from a vendor. The requirements of these lubricants are 1800 per year. What should be the ordering quantity per order, if the cost per placement of an order is Rs. 16 and inventory carrying charges per rupee per year is 20 paise.

**SOLUTION:** Given data are:

Number of lubricants to be purchased,  $D = 1800$  per year

Procurement cost,  $C_3 = \text{Rs. } 16$  per order

Inventory carrying cost,  $CI = C_1 = \text{Rs. } 42 \times \text{Re. } 0.20 = \text{Rs. } 8.40$  per year

$$\text{Then, optimal quantity (EOQ), } Q_0 = \sqrt{\frac{2C_3D}{C_1}}$$

$$Q_0 = \sqrt{\frac{2 \times 16 \times 1800}{8.4}} = 82.8 \text{ or } 83 \text{ lubricants (approx).}$$

**ILLUSTRATION 5:** A manufacturing company purchase 9000 parts of a machine for its annual requirements ordering for month usage at a time, each part costs Rs. 20. The ordering cost per order is Rs. 15 and carrying charges are 15% of the average inventory per year. You have been assigned to suggest a more economical purchase policy for the company. What advice you offer and how much would it save the company per year?

**SOLUTION:** Given data are:

Number of lubricants to be purchased,  $D = 9000$  parts per year

Cost of part,  $C_s = \text{Rs. } 20$

Procurement cost,  $C_3 = \text{Rs. } 15$  per order

Inventory carrying cost,  $CI = C_1 = 15\%$  of average inventory per year  
 $= \text{Rs. } 20 \times 0.15 = \text{Rs. } 3$  per each part per year

Then, optimal quantity (EOQ),  $Q_0 = \sqrt{\frac{2C_3D}{C_1}}$

$$Q_0 = \sqrt{\frac{2 \times 15 \times 9000}{3}} = 300 \text{ units}$$

and Optimum order interval,  $(t_0) = \frac{Q_0}{D}$  in years  $= \frac{300}{9000} = \frac{1}{30}$  years  
 $= \frac{1}{30} \times 365 \text{ days} = 122 \text{ Days}$

$$\text{Minimum average cost} = \sqrt{2C_3DC_1} = \sqrt{2 \times 3 \times 15 \times 9000} = \text{Rs. } 900$$

If the company follows the policy of ordering every month, then the annual ordering cost is

$$= \text{Rs } 12 \times 15 = \text{Rs. } 180$$

Lot size of inventory each month  $= 9000/12 = 750$

$$\text{Average inventory at any time} = \frac{Q}{2} = 750/2 = 375$$

Therefore, storage cost at any time  $= 375 \times C_1 = 375 \times 3 = \text{Rs. } 1125$

$$\text{Total annual cost} = 1125 + 180 = \text{Rs. } 1305$$

Hence, the company should purchase 300 parts at time interval of  $1/30$  year instead of ordering 750 parts each month. The net saving of the company will be

$$= \text{Rs. } 1305 - \text{Rs. } 900 = \text{Rs. } 405 \text{ per year.}$$

## 4.7 STANDARDIZATION

Standardization means producing maximum variety of products from the minimum variety of materials, parts, tools and processes. It is the process of establishing standards or units of measure by which extent, quality, quantity, value, performance etc., may be compared and measured.

### 4.7.1 Advantages of Standardization

All the sections of company will be benefited from standardization as mentioned below.

#### **Benefits to Design Department**

1. Fewer specifications, drawings and part list have to prepared and issued.
2. More time is available to develop new design or to improve established design.
3. Better resource allocation.
4. Less qualified personnel can handle routine design work.

#### **Benefits to Manufacturing Department**

1. Lower unit cost.
2. Better quality products.
3. Better methods and tooling.
4. Increased interchangeability of parts.
5. Better utilization of manpower and equipment.
6. Accurate delivery dates.
7. Better services of production control, stock control, purchasing, etc.
8. More effective training.

#### **Benefits to Marketing Department**

1. Better quality products of proven design at reasonable cost leads to greater sales volume.
2. Increased margin of profit.
3. Better product delivery.
4. Easy availability of sales part.
5. Less sales pressure of after-sales services.

#### **Benefits to Production Planning Department**

1. Scope for improved methods, processes and layouts.
2. Opportunities for more efficient tool design.
3. Better resource allocation.
4. Reduction in pre-production activities.

#### **Benefits to Production Control Department**

1. Well proven design and methods improve planning and control.
2. Accurate delivery promises.
3. Fewer delays arise from waiting for materials, tools, etc.
4. Follow-up of small batches consumes less time.

#### **Benefits to Purchase and Stock Control Department**

1. Holding of stock of standard items leads to less paper work and fewer requisitions and orders.



2. Storage and part location can be improved.
3. Newer techniques can be used for better control of stocks.
4. Because of large purchase quantities involved, favourable purchase contracts can be made.

#### **Benefits to Quality Control Department**

1. Better inspection and quality control is possible.
2. Quality standards can be defined more clearly.
3. Operators become familiar with the work and produce jobs of consistent quality.

#### **Other Benefits**

1. Work study section is benefited with efficient break down of operations and effective work measurement.
2. Costing can obtain better control by installing standard costing.
3. More time is available to the supervisors to make useful records and preserve statistics.
4. Reduced reductions and scrap.
5. Helps supervisors to run his department efficiently and effectively.

#### **4.7.2 Disadvantages of Standardization**

Following are the disadvantages of standardization:

1. Reduction in choice because of reduced variety and consequently loss of business or customer.
2. Standard once set, resist change and thus standardization may become an obstacle to progress.
3. It tends to favour only large companies.
4. It becomes very difficult to introduce new models because of less flexible production facilities and due to high cost of specialised production equipment.

### **4.8 SIMPLIFICATION**

The concept of simplification is closely related to standardization. Simplification is the process of reducing the variety of products manufactured. Simplification is concerned with the reduction of product range, assemblies, parts, materials and design.

#### **4.8.1 Advantages of Simplification**

Following are the advantages of simplification:

1. Simplification involves fewer, parts, varieties and changes in products; this reduces manufacturing operations and risk of obsolescence.
2. Simplification reduces variety, volume of remaining products may be increased.
3. Simplification provides quick delivery and better after-sales services.
4. Simplification reduces inventory and thus results in better inventory control.

5. Simplification lowers the production costs.
6. Simplification reduces price of a product.
7. Simplification improves product quality.

## 4.9 VALUE ANALYSIS

Value engineering or value analysis had its birth during the World War II Lawrence D. Miles was responsible for developing the technique and naming it. Value analysis is defined as “an organized creative approach which has its objective, the efficient identification of unnecessary cost-cost which provides neither quality nor use nor life nor appearance nor customer features.” Value analysis focuses engineering, manufacturing and purchasing attention to one objective-equivalent performance at a lower cost.

Value analysis is concerned with the costs added due to inefficient or unnecessary specifications and features. It makes its contribution in the last stage of product cycle, namely, the maturity stage. At this stage, research and development no longer make positive contributions in terms of improving the efficiency of the functions of the product or adding new functions to it.

Value is not inherent in a product, it is a relative term, and value can change with time and place. It can be measured only by comparison with other products which perform the same function. Value is the relationship between what someone wants and what he is willing to pay for it. In fact, the heart of value analysis technique is the functional approach. It relates to cost of function whereas others relate cost to product. It is denoted by the ratio between function and cost.

$$\text{Value} = \frac{\text{Function}}{\text{Cost}}$$

### 4.9.1 Value Analysis Framework

The basic framework for value analysis approach is formed by the following questions, as given by Lawrence D. Miles:

1. What is the item?
2. What does it do?
3. What does it cost?
4. What else would do the job?
5. What would the alternative cost be?

Value analysis requires these questions to be answered for the successful implementation of the technique.

### 4.9.2 Steps in Value Analysis

In order to answer the above questions, three **basic steps** are necessary:

1. **Identifying the function:** Any useful product has some primary function which must be identified—a bulb to give light, a refrigerator to preserve food, etc. In addition it may have secondary functions such as withstanding shock, etc. These two must be identified.

2. **Evaluation of the function by comparison:** Value being a relative term, the comparison

approach must be used to evaluate functions. The basic question is, 'Does the function accomplish reliability at the best cost' and can be answered only comparison.

3. **Develop alternatives:** Realistic situations must be faced, objections should overcome and effective engineering manufacturing and other alternatives must be developed. In order to develop effective alternatives and identify unnecessary cost the following thirteen value analysis principles must be used:

1. Avoid generalities.
2. Get all available costs.
3. Use information only from the best source.
4. Brain-storming sessions.
5. Blast, create and refine: In the blast stage, alternative productive products, materials, processes or ideas are generated. In the 'create' stage the ideas generated in the blast stage are used to generate alternatives which accomplish the function almost totally. In the refining stage the alternatives generated are sifted and refined so as to arrive at the final alternative to be implemented.
6. Identify and overcome road blocks.
7. Use industry specialists to extend specialised knowledge.
8. Key tolerance not to be too light.
9. Utilise the pay for vendors' skills techniques.
10. Utilise vendors' available functional products.
11. Utilise speciality processes.
12. Utilise applicable standards.
13. Use the criterion 'Would I spend my money this way?'

#### 4.10 ERGONOMICS (HUMAN ENGINEERING)

The word 'Ergonomics' has its origin in two Greek words *Ergon* meaning laws. So it is the study of the man in relation to his work. In USA and other countries it is called by the name 'human engineering or human factors engineering'. ILO defines human engineering as, "The application of human biological sciences along with engineering sciences to achieve optimum mutual adjustment of men and his work, the benefits being measured in terms of human efficiency and well-being."

The human factors or human engineering is concerned with man-machine system. Thus another definition which highlights the man-machine system is: "The design of human tasks, man-machine system, and effective accomplishment of the job, including displays for presenting information to human sensors, controls for human operations and complex man-machine systems."

Human engineering focuses on human beings and their interaction with products, equipment facilities and environments used in the work. Human engineering seeks to change the things people use and the environment in which they use the things to match in a better way the capabilities, limitations and needs of people.

### 4.10.1 Objectives of Human Engineering

Human engineering (ergonomics) has two broader objectives:

1. To enhance the efficiency and effectiveness with which the activities (work) is carried out so as to increase the convenience of use, reduced errors and increase in productivity.
2. To enhance certain desirable human values including safety reduced stress and fatigue and improved quality of life.

Thus, in general the scope and objective of ergonomics is “designing for human use and optimising working and living conditions”. Thus human factors (ergonomics) discover and apply information about human behaviour. Abilities and limitations and other characteristics to the design of tools, machines, systems, tasks, jobs and environment for productive, safe, comfortable and effective human use. Ergonomics aims at providing comfort and improved working conditions so as to channelise the energy, skills of the workers into constructive productive work. This accounts for increased productivity, safety and reduces the fatigue. This helps to increase the plant utilisation.

## 4.11 JUST-IN-TIME (JIT) MANUFACTURING

### Introduction

Just-In-Time (JIT) Manufacturing is a philosophy rather than a technique. By eliminating all waste and seeking continuous improvement, it aims at creating manufacturing system that is response to the market needs.

The phase just in time is used to because this system operates with low WIP (Work-In-Process) inventory and often with very low finished goods inventory. Products are assembled just before they are sold, subassemblies are made just before they are assembled and components are made and fabricated just before subassemblies are made. This leads to lower WIP and reduced lead times. To achieve this organizations have to be excellent in other areas *e.g.* quality.

According to Voss, JIT is viewed as a “*Production methodology which aims to improve overall productivity through elimination of waste and which leads to improved quality*”. JIT provides an efficient production in an organization and delivery of only the necessary parts in the right quantity, at the right time and place while using the minimum facilities”.

### 4.11.1 Seven Wastes

Shiego Shingo, a Japanese JIT authority and engineer at the Toyota Motor Company identifies seven wastes as being the targets of continuous improvement in production process. By attending to these wastes, the improvement is achieved.

1. Waste of over production eliminate by reducing set-up times, synchronizing quantities and timing between processes, layout problems. Make only what is needed now.
2. Waste of waiting eliminate bottlenecks and balance uneven loads by flexible work force and equipment.

3. Waste of transportation establish layouts and locations to make handling and transport unnecessary if possible. Minimise transportation and handling if not possible to eliminate.
4. Waste of processing itself question regarding the reasons for existence of the product and then why each process is necessary.
5. Waste of stocks reducing all other wastes reduces stocks.

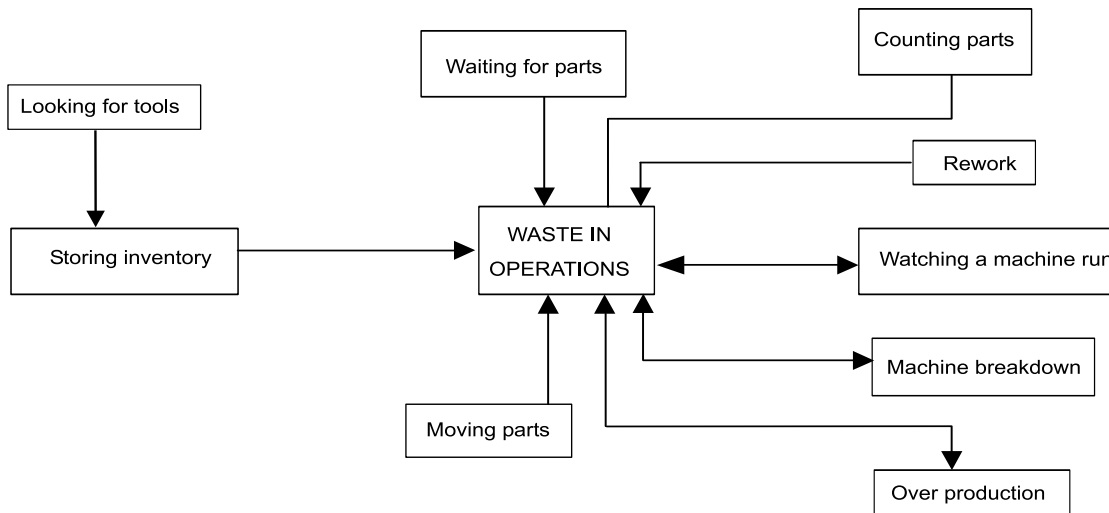

**Fig. 4.8** Wastes in operations

6. Waste of motion study for economy and consistency. Economy improves productivity and consistency improves quality. First improve the motions, then mechanise or automate otherwise. There is danger of automating the waste.
7. Waste of making defective products develop the production process to prevent defects from being produced, so as to eliminate inspection. At each process, do not accept defects and makes no defects. Make the process fail-safe. A quantify process always yield quality product.

#### 4.11.2 Benefits of JIT

The most significant benefit is to improve the responsiveness of the firm to the changes in the market place thus providing an advantage in competition. Following are the benefits of JIT:

1. *Product cost*—is greatly reduced due to reduction of manufacturing cycle time, reduction of waste and inventories and elimination of non-value added operation.
2. *Quality*—is improved because of continuous quality improvement programmes.
3. *Design*—Due to fast response to engineering change, alternative designs can be quickly brought on the shop floor.
4. Productivity improvement.
5. Higher production system flexibility.
6. Administrative and ease and simplicity.

## EXERCISES

### Section A

1. What do you mean by materials management?
2. What is material planning and budgeting?
3. What do you mean by purchasing?
4. What do you mean by 'Inventory Management'?
5. What do you mean by 'Inventory Control'?
6. What is codification?
7. What do you mean by 'Standardisation'?
8. What do you mean by 'Simplification'?
9. What is 'Value Analysis'?
10. What do you mean by 'Ergonomics'?
11. What is EOQ?

### Section B

1. Explain the objectives of materials management.
2. What are the functions of stores?
3. Explain the reasons for keeping inventories.
4. What are the objectives of inventory control?
5. What are the benefits of inventory control?
6. What are the objectives of codification?
7. What are the advantages of simplification?
8. Explain the basic steps in value analysis.
9. Explain the objective of 'Ergonomics'.

### Section C

1. Discuss the scope of materials management.
2. Discuss the parameters of purchasing.
3. Discuss the ten 'R' 's of purchasing.
4. Discuss the purchasing procedure.
5. Discuss the selection of suppliers.
6. Discuss the benefits of standardisation.

### Skill Development

**FAST FOOD RESTAURANT VISIT:** Get the information for the following questions:

1. Material Requirement Plan for procurements of Raw material.
2. Purchase procedures adopted.
3. Preparation of Bill of Material.
4. The supplier or vendors selection.
5. In process, spares and etc.
6. Adaptation of Just In Time Manufacturing Technique.

## CASELET

**THE MIXING AND BAGGING COMPANY**

The Mixing and Bagging Company produces a line of commercial animal feeds in 10 mixes. The production process itself is simple. A variety of basic grain and filler ingredients is mixed in batches. The mixture is then fed to an intermediate storage hopper, from which it is conveyed to a bagging operation. The bags of feed are then loaded on pallets and moved to the nearby warehouse for storage.

A foreman supervises the operations. A full-time worker who operates the mixing and blending equipment, plus four full-time and 10 part-time workers provide direct labor. The foreman is paid Rs.15, 000 per year; the mixer-operator, Rs. 5 per hour; the other full-time workers, Rs. 4 per hour; and the 10 part-time workers, Rs. 3 per hour.

The usual routine for a production run is as follows: The foreman receives job tickets from the office indicating the quantities to be run and the formula. The job tickers are placed in the order in which they are to be processed. At the end of a run, the foreman purges the mixing system and ducts of the previous product. This takes 20 minutes.

Meanwhile, the foreman has directed the mixer-operator and the four full-time employees to obtain the required ingredients for the next product from the storeroom. When the mixing equipment has been purged, the mixer and gets it started. This takes about 10 minutes. The total time spent by the mixer-operates in obtaining materials and loading the mixer is 30 minutes. The four full-time employees devote 30 minutes to obtaining materials.

While the previous activities are being performed the foreman turns his attention to the bagger line, which requires minor change over for bag size and the product identifying lable that is sewed to the top of bag as it is sewed closed.

While the foreman is purging the system, the 10 part-time employees transfer what is left of the last run to the warehouse, which requires about 15 minutes. They then idle until the finished goods warehouse is valued according to the sale price of each item, which is about Rs. 5 per 100 kg. The cost of placing items in the warehouse has been calculated as approximately Re. 0.20 per 100 kg, based on the time required for one of the part-time workers to truck it to the warehouse and place it in the proper location. The front office has calculated that the storage space in the owned warehouse is worth about Rs. 10 per square foot per year, but because the bags are palletized and stacked 12 feet high, this cost has been reduced to only Re. 0.20 per 100 kg per year. The product mixes are stable, and there is very little risk of obsolescence. There is some loss because uninvited guests (rats, etc.) come in to dine. The total storage and obsolescence costs ate estimated as 5 per cent of inventory value.

The Mixing and Bagging Company has a factory overhead rate that it applied to materials and direct labor. This overhead rate is currently 100 percent and is applied to the average material cost of Rs. 1.87 per 10 kg plus direct labor costs of Re. 0.13 per 10 kg. The company earns 8 per cent after taxes and can borrow at the local bank at an interest rate of 9 per cent.

The factory manager is currently reviewing the bases for deciding the length of production runs for products. He figures that operations are currently at about 85 per cent of capacity. He has heard of EOQ as a basis for setting the length of production runs. What values should he assign to  $c_p$  and  $c_H$  for his operations?

[Source: *Modern Production/Operations Management by Elwood S.Buffa & Rakesh K.Sarin*]

# 5

## PRODUCTION PLANNING AND CONTROL

### CHAPTER OUTLINE

- |   |  |
|---|--|
| 5.1 <i>Introduction and Meaning</i>                   | 5.8 <i>Master Production Schedule</i>  |
| 5.2 <i>Need for Production Planning and Control</i>   | 5.9 <i>Material Requirement Planning</i>   |
| 5.3 <i>Objectives of PP &amp; C</i>                   | 5.10 <i>Capacity Planning</i>  |
| 5.4 <i>Phases of PP &amp; C</i>                       | 5.11 <i>Routing</i>  |
| 5.5 <i>Functions of PP &amp; C</i>                    | 5.12 <i>Scheduling</i>   |
| 5.6 <i>Operations Planning and Scheduling Systems</i> | 5.13 <i>Scheduling Methodology</i>   |
| 5.7 <i>Aggregate Planning</i>                         | <ul style="list-style-type: none"><li>• <i>Exercises</i></li><li>• <i>Skill Development</i></li><li>• <i>Caselet</i></li></ul> |

### 5.1 INTRODUCTION AND MEANING

Production planning and control is a tool available to the management to achieve the stated objectives. Thus, a production system is encompassed by the four factors. *i.e.*, quantity, quality, cost and time. Production planning starts with the analysis of the given data, *i.e.*, demand for products, delivery schedule etc., and on the basis of the information available, a scheme of utilisation of firms resources like machines, materials and men are worked out to obtain the target in the most economical way.

Once the plan is prepared, then execution of plan is performed in line with the details given in the plan. Production control comes into action if there is any deviation between the actual and planned. The corrective action is taken so as to achieve the targets set as per plan by using control techniques.

Thus production planning and control can be defined as the “*direction and coordination of firms’ resources towards attaining the prefixed goals.*” Production planning and control helps to achieve uninterrupted flow of materials through production line by making available the materials at right time and required quantity.



## 5.2 NEED FOR PRODUCTION PLANNING AND CONTROL

The present techno-economic scenario of India emphasize on competitiveness in manufacturing. Indian industries have to streamline the production activities and attain the maximum utilisation of firms' resources to enhance the productivity. Production planning and control serves as a useful tool to coordinate the activities of the production system by proper planning and control system. Production system can be compared to the nervous system with PPC as a brain. Production planning and control is needed to achieve:

1. Effective utilisation of firms' resources.
2. To achieve the production objectives with respect to quality, quantity, cost and timeliness of delivery.
3. To obtain the uninterrupted production flow in order to meet customers varied demand with respect to quality and committed delivery schedule.
4. To help the company to supply good quality products to the customer on the continuous basis at competitive rates.

Production planning is a pre-production activity. It is the pre-determination of manufacturing requirements such as manpower, materials, machines and manufacturing process.

Ray wild defines "*Production planning is the determination, acquisition and arrangement of all facilities necessary for future production of products.*" It represents the design of production system. Apart from planning the resources, it is going to organize the production.

Based on the estimated demand for company's products, it is going to establish the production programme to meet the targets set using the various resources.

### Production Control

Inspite of planning to the minute details, most of the time it is not possible to achieve production 100 per cent as per the plan. There may be innumerable factors which affect the production system and because of which there is a deviation from the actual plan. Some of the factors that affect are:

1. Non-availability of materials (due to shortage, etc.);
2. Plant, equipment and machine breakdown;
3. Changes in demand and rush orders;
4. Absenteeism of workers; and
5. Lack of coordination and communication between various functional areas of business.

Thus, if there is a deviation between actual production and planned production, the control function comes into action. Production control through control mechanism tries to take corrective action to match the planned and actual production. Thus, production control reviews the progress of the work, and takes corrective steps in order to ensure that programmed production takes place. The essential steps in control activity are:

1. Initiating the production,
2. Progressing, and
3. Corrective action based upon the feedback and reporting back to the production planning.

**5.3 OBJECTIVES OF PRODUCTION PLANNING AND CONTROL**

Following are the objectives of production planning and control:

1. Systematic planning of production activities to achieve the highest efficiency in production of goods/services.
2. To organize the production facilities like machines, men, etc., to achieve stated production objectives with respect to quantity and quality time and cost.
3. Optimum scheduling of resources.
4. Coordinate with other departments relating to production to achieve regular balanced and uninterrupted production flow.
5. To conform to delivery commitments.
6. Materials planning and control.
7. To be able to make adjustments due to changes in demand and rush orders.

**5.4 PHASES OF PRODUCTION PLANNING AND CONTROL**

Production planning and control has three phases namely:

- A. Planning Phase
- B. Action Phase
- C. Control Phase

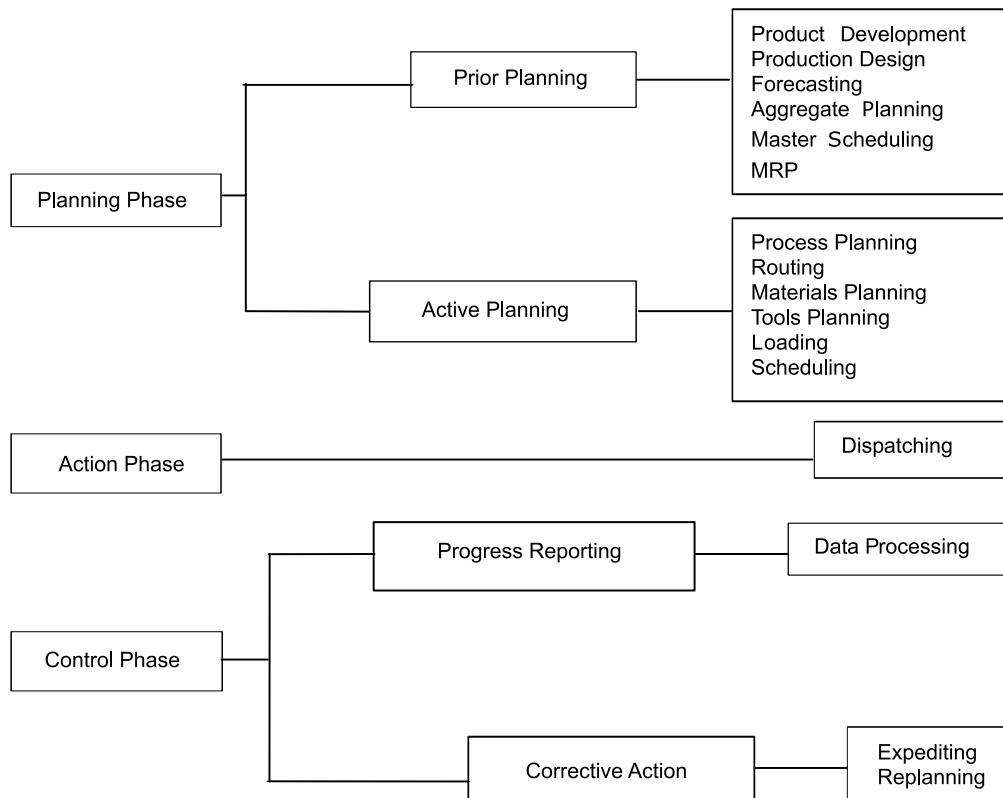

**Fig. 5.1** Phases of production planning and control

### 5.4.1 Planning Phase

**Planning** is an exercise of intelligent anticipation in order to establish how an objective can be achieved or a need fulfilled in circumstances, which are invariably restrictive. Production planning determines the optimal schedule and sequence of operations economic batch quantity, machine assignment and dispatching priorities for sequencing.

It has two categories of planning namely

1. Prior planning
2. Active planning.

#### **PRIOR PLANNING**

Prior planning means pre-production planning. This includes all the planning efforts, which are taking place prior to the active planning.

#### **Modules of pre-planning**

The modules of prior planning are as follows:

1. **Product development and design** is the process of developing a new product with all the features, which are essential for effective use in the field, and designing it accordingly. At the design stage, one has to take several aspects of design like, design for selling, design for manufacturing and design for usage.
2. **Forecasting** is an estimate of demand, which will happen in future. Since, it is only an estimate based on the past demand, proper care must be taken while estimating it. Given the sales forecast, the factory capacity, the aggregate inventory levels and size of the work force, the manager must decide at what rate of production to operate the plant over an intermediate planning horizon.
3. **Aggregate planning** aims to find out a product wise planning over the intermediate planning horizon.
4. **Material requirement planning** is a technique for determining the quantity and timing for the acquisition of dependent items needed to satisfy the master production schedule.

#### **ACTIVE PLANNING**

The modules of active planning are: Process planning and routing, Materials planning. Tools planning, Loading, Scheduling etc.

1. **Process planning and routing** is a complete determination of the specific technological process steps and their sequence to produce products at the desired quality, quantity and cost. It determines the method of manufacturing a product selects the tools and equipments, analyses how the manufacturing of the product will fit into the facilities. Routing in particular prescribes the flow of work in the plant and it is related to the considerations of layout, temporary locations for raw materials and components and materials handling systems.
2. A **material planning** is a process which determines the requirements of various raw materials/subassemblies by considering the trade-off between various cost components like, carrying cost, ordering cost, shortage cost, and so forth.

3. **Tools' planning** determines the requirements of various tools by taking process specification (surface finish, length of the job, overall depth of cut etc.), material specifications (type of material used, hardness of the material, shape and size of the material etc.) and equipment specifications (speed range, feed range, depth of cut range etc.).
4. **Loading** is the process of assigning jobs to several machines such that there is a load balance among the machines. This is relatively a complex task, which can be managed with the help of efficient heuristic procedures.
5. **Scheduling** is the time phase of loading and determines when and in what sequence the work will be carried out. This fixes the starting as well as the finishing time for each job.

#### 5.4.2 Action Phase

Action phase has the major step of **dispatching**. Dispatching is the transition from planning phase to action phase. In this phase, the worker is ordered to start manufacturing the product. The tasks which are included in dispatching are job order, store issue order, tool order, time ticket, inspection order, move order etc.

The **job order** number is the key item which is to be mentioned in all other reports/orders. **Stores issue order** gives instruction to stores to issue materials for manufacturing the product as per product specifications. As per tooling requirements for manufacturing the product, the **tool order** instruct the tool room to issue necessary tools. **Time ticket** is nothing but a card which is designed to note down the actual time taken at various processes. This information is used for deciding the costs for future jobs of similar nature and also for performing variance analysis, which helps to exercise control.

Job order is the official authorization to the shop floor to start manufacturing the product. Generally, the process sequence will contain some testing and inspection. So, these are to be instructed to inspection wing in the form of inspection order for timely testing and inspection so that the amount of rework is minimized. The manufacture of product involves moving raw materials/subassemblies to the main line. This is done by a well-designed materials handling system. So, proper instruction is given to the materials handling facilities for major movements of materials/subassemblies in the form of a move order. Movements which involve less distance and fewer loads are managed at the shop floor level based on requests from operators.

#### 5.4.3 Control Phase

The control phase has the following two major modules:

1. Progress reporting, and
2. Corrective action.

##### 1. PROGRESS REPORTING

In progress reporting, the data regarding what is happening with the job is collected. Also, it helps to make comparison with the present level of performance. The various data pertaining to materials rejection, process variations, equipment failures, operator efficiency, operator absenteeism, tool life, etc., are collected and analyzed for the purpose of progress reporting. These data are

used for performing variance analysis, which would help us to identify critical areas that deserve immediate attention for corrective actions.

## 2. CORRECTIVE ACTION

The tasks under corrective action primarily make provisions for an unexpected event. Some examples of corrective actions are creating schedule flexibility, schedule modifications, capacity modifications, make or buy decisions, expediting the work, pre-planning, and so on. Due to unforeseen reasons such as, machine breakdown, labour absenteeism, too much rejection due to poor material quality etc., it may not be possible to realize the schedule as per the plan. Under such condition, it is better to reschedule the whole product mix so that we get a clear picture of the situation to progress further. Under such situation, it is to be re-examined for selecting appropriate course of action. Expediting means taking action if the progress reporting indicates deviations from the originally set targets. Pre-planning of the whole affair becomes essential in case the expediting fails to bring the deviated plan to its right path.

## 5.5 FUNCTIONS OF PRODUCTION PLANNING AND CONTROL

Functions of production planning and controlling is classified into:

1. Pre-planning function
2. Planning function
3. Control function

The functions of production planning and controlling are depicted in the Fig. 5.2.

### 1. PRE-PLANNING FUNCTION

Pre-planning is a macro level planning and deals with analysis of data and is an outline of the planning policy based upon the forecasted demand, market analysis and product design and

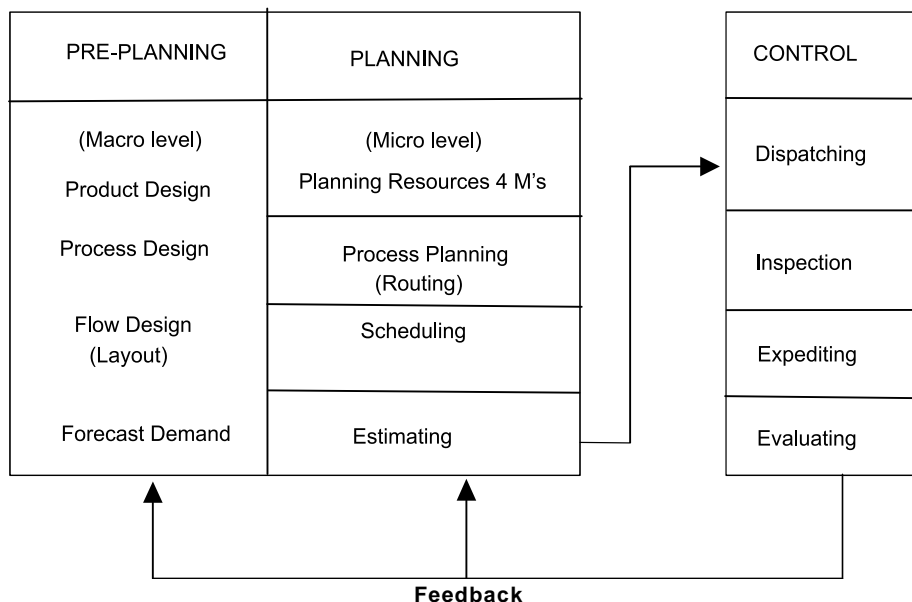

**Fig. 5.2** Functions of production planning and control

development. This stage is concerned with process design (new processes and developments, equipment policy and replacement and work flow (Plant layout). The pre-planning function of PPC is concerned with decision-making with respect to methods, machines and work flow with respect to availability, scope and capacity.

## 2. PLANNING FUNCTION

The planning function starts once the task to be accomplished is specified, with the analysis of **four M's**, *i.e.*, Machines, Methods, Materials and Manpower. This is followed by process planning (routing). Both short-term (near future) and long-term planning are considered. Standardisation, simplification of products and processes are given due consideration.

## 3. CONTROL FUNCTION

Control phase is effected by dispatching, inspection and expediting materials control, analysis of work-in-process. Finally, evaluation makes the PPC cycle complete and corrective actions are taken through a feedback from analysis. A good communication, and feedback system is essential to enhance and ensure effectiveness of PPC.

### 5.5.1 Parameters for PPC

The functions of PPC can be explained with the following parameters:

1. **Materials:** Raw materials, finished parts and bought out components should be made available in required quantities and at required time to ensure the correct start and end for each operation resulting in uninterrupted production. The function includes the specification of materials (quality and quantity) delivery dates, variety reduction (standardisation) procurement and make or buy decisions.

2. **Machines and equipment:** This function is related with the detailed analysis of available production facilities, equipment down time, maintenance policy procedure and schedules. Concerned with economy of jigs and fixtures, equipment availability. Thus, the duties include the analysis of facilities and making their availability with minimum down time because of breakdowns.

3. **Methods:** This function is concerned with the analysis of alternatives and selection of the best method with due consideration to constraints imposed. Developing specifications for processes is an important aspect of PPC and determination of sequence of operations.

4. **Process planning (Routing):** It is concerned with selection of path or route which the raw material should follow to get transformed into finished product. The duties include:

- (a) Fixation of path of travel giving due consideration to layout.
- (b) Breaking down of operations to define each operation in detail.
- (c) Deciding the set up time and process time for each operation.

5. **Estimating:** Once the overall method and sequence of operations is fixed and process sheet for each operation is available, then the operations times are estimated. This function is carried out using extensive analysis of operations along with methods and routing and a standard time for operation are established using work measurement techniques.

6. **Loading and scheduling:** Scheduling is concerned with preparation of machine loads and fixation of starting and completion dates for each of the operations. Machines have to be

loaded according to their capability of performing the given task and according to their capacity. Thus the duties include:

- (a) Loading, the machines as per their capability and capacity.
- (b) Determining the start and completion times for each operation.
- (c) To coordinate with sales department regarding delivery schedules.

7. **Dispatching:** This is the execution phase of planning. It is the process of setting production activities in motion through release of orders and instructions. It authorises the start of production activities by releasing materials, components, tools, fixtures and instruction sheets to the operator. The activities involved are:

- (a) To assign definite work to definite machines, work centres and men.
- (b) To issue required materials from stores.
- (c) To issue jigs, fixtures and make them available at correct point of use.
- (d) Release necessary work orders, time tickets, etc., to authorise timely start of operations.
- (e) To record start and finish time of each job on each machine or by each man.

8. **Expediting:** This is the control tool that keeps a close observation on the progress of the work. It is logical step after dispatching which is called 'follow-up'. It coordinates extensively to execute the production plan. Progressing function can be divided into three parts, *i.e.*, follow up of materials, follow up of work-in-process and follow up of assembly. The duties include:

- (a) Identification of bottlenecks and delays and interruptions because of which the production schedule may be disrupted.
- (b) To devise action plans (remedies) for correcting the errors.
- (c) To see that production rate is in line with schedule.

9. **Inspection:** It is a major control tool. Though the aspects of quality control are the separate function, this is of very much important to PPC both for the execution of the current plans and its scope for future planning. This forms the basis for knowing the limitations with respects to methods, processes, etc., which is very much useful for evaluation phase.

10. **Evaluation:** This stage though neglected is a crucial to the improvement of productive efficiency. A thorough analysis of all the factors influencing the production planning and control helps to identify the weak spots and the corrective action with respect to pre-planning and planning will be effected by a feedback. The success of this step depends on the communication, data and information gathering and analysis.

## 5.6 OPERATIONS PLANNING AND SCHEDULING SYSTEMS

Operations planning and scheduling systems concern with the volume and timing of outputs, the utilisation of operations capacity at desired levels for competitive effectiveness. These systems must fit together activities at various levels, from top to bottom, in support of one another, as shown in Fig. 5.3. Note that the time orientation ranges from long to short as we progress from top to bottom in the hierarchy. Also, the level of detail in the planning process ranges from broad at the top to detail at the bottom.

## Components of Operations Planning and Scheduling System

### 1. THE BUSINESS PLAN

The business plan is a statement of the organization's overall level of business activity for the coming six to eighteen months, usually expressed in terms of outputs (in volume of sales) for its various product groups, a set of individual products that share or consume common blocks of capacity in the manufacturing process. It also specifies the overall inventory and backlog levels that will be maintained during the planning period. The business plan is an agreement between all functional areas—finance, production, marketing, engineering, R & D—about the level of activity and the products they are committed to support. The business plan is not concerned with all the details and specific timing of the actions for executing the plan. Instead, it determines a feasible general posture for competing to achieve its major goals. The resulting plan guides the lower-level, more details decisions.

### 2. AGGREGATE PRODUCTION (OUTPUT) PLANNING

The process of determining output levels of product groups over the coming six to eighteen months on a weekly or monthly basis. It identifies the overall level of outputs in support of the business plan. The plan recognizes the division's existing fixed capacity and the company's overall policies for maintaining inventories and backlogs, employment stability and subcontracting.

### 3. AGGREGATE CAPACITY PLANNING

It is the process of testing the feasibility of aggregate output plans and evaluating overall capacity utilisation. A statement of desired output is useful only if it is feasible. Thus, it addresses the supply side of the firm's ability to meet the demand. As for aggregate output plans, each plant, facility, or division requires its own aggregate capacity plan. Capacity and output must be in balance, as indicated by the arrow between them in Fig. 5.3. A capacity plan translates an output plan into input terms, approximating how much of the division's capacity will be consumed. Although these basic capacities are fixed, management can manipulate the short-term capacities by the ways they deploy their work force, by subcontracting, or by using multiple work shifts to adjust the timing of overall outputs. As a result, the aggregate planning process balances output levels, capacity constraints, and temporary capacity adjustments to meet demand and utilise capacity at desired levels during the coming months. The resulting plan sets limits on the master production schedule.

### 4. MASTER PRODUCTION SCHEDULING (MPS)

MPS is a schedule showing week by week how many of each product must be produced according to customer orders and demand forecasts. Its purpose is to meet the demand for individual products in the product group. This more detailed level of planning disaggregates the product groups into individual products and indicates when they will be produced. The MPS is an important link between marketing and production. It shows when incoming sales orders can be scheduled into production, and when each shipment can be scheduled for delivery. It also takes into account current backlogs so that production and delivery schedules are realistic.



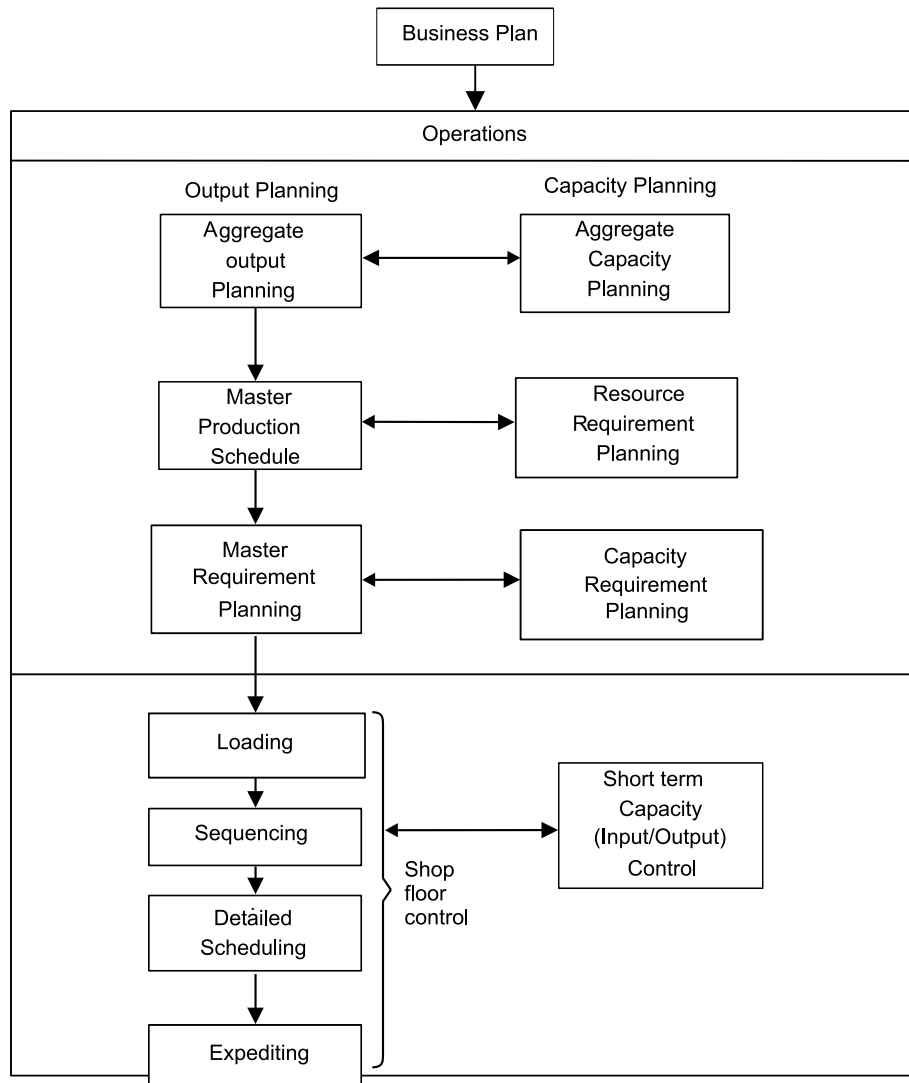

**Fig. 5.3** *Operations planning and scheduling system*

### 5. RESOURCE REQUIREMENT PLANNING

Resource requirement planning (rough-cut capacity planning) is the process of testing the feasibility of master production schedule in terms of capacity. This step ensures that a proposed MPS does not inadvertently overload any key department, work centre, or machine, making the MPS unworkable.

### 6. MATERIAL REQUIREMENT PLANNING

Material requirement planning (MRP) is a system of planning and scheduling the time phased material requirements for releasing materials and receiving materials that enable the master production schedule to be implemented. Thus, the master production schedule is the driving force

for material requirements planning. MRP provides information such as due dates for components that are subsequently used for shop floor control. Once this information is available, it enables managers to estimate the detailed requirements for each work centres.

### **7. CAPACITY REQUIREMENT PLANNING**

Capacity requirement planning (CRP) is an iterative process of modifying the MPS or planned resources to make capacity consistent with the production schedule. CRP is a companion process used with MRP to identify in detail the capacity required to execute the material requirement planning. At this level, more accurate comparisons of available and needed capacity for scheduled workloads are possible.

### **8. SHOP FLOOR CONTROL**

Shop floor control involves the activities that execute and control shop operations namely loading, sequencing, detailed scheduling and expediting jobs in production. It coordinates the weekly and daily activities that get jobs done. Individual jobs are assigned to machines and work centres (loading), the sequence of processing the jobs for priority control is determined, start times and job assignments for each stage of processing are decided (detailed scheduling ) and materials and work flows from station to station are monitored and adjusted (expediting).

### **9. LOADING**

Each job (customer order) may have its unique product specification and, hence, it is unique through various work centres in the facility. As new job orders are released, they are assigned or allocated among the work centres, thus establishing how much of a load each work centre must carry during the coming planning period. This assignment is known as loading (sometimes called shop loading as machine loading).

### **10. SEQUENCING**

This stage establishes the priorities for jobs in the queues (waiting lines) at the work centres. Priority sequencing specifies the order in which the waiting jobs are processed; it requires the adoption of a priority sequencing rule.

### **11. DETAILED SCHEDULING**

Detailed scheduling determines start times, finish times and work assignments for all jobs at each work centre. Calendar times are specified when job orders, employees, and materials (inputs), as well as job completion (outputs), should occur at each work centre. By estimating how long each job will take to complete and when it is due, schedulers can establish start and finish dates and develop the detailed schedule.

### **12. EXPEDITING**

Expediting is a process of tracking a job's progress and taking special actions to move it through the facility. In tracking a job's progress, special action may be needed to keep the job moving through the facility on time. Manufacturing or service operations disruptions-equipments breakdowns, unavailable materials, last-minute priority changes, require managers to deviate from plans and schedules and expedite an important job on a special handling basis.

### 13. INPUT/OUTPUT CONTROL

Input/output control related to the activities to monitor actual versus planned utilisation of a work centre's capacity. Output plans and schedules call for certain levels of capacity at a work centre, but actual utilisation may differ from what was planned. Actual versus planned utilisation of the work centre's capacity can be monitored by using input-output reports and, when discrepancies exist, adjustments can be made. The important components of operations planning and scheduling system has been explained in detail in the following paragraphs.

#### 5.7 AGGREGATE PLANNING

Aggregate planning is an intermediate term planning decision. It is the process of planning the quantity and timing of output over the intermediate time horizon (3 months to one year). Within this range, the physical facilities are assumed to be fixed for the planning period. Therefore, fluctuations in demand must be met by varying labour and inventory schedule. Aggregate planning seeks the best combination to minimise costs.

#### Aggregate Planning Strategies

The variables of the production system are labour, materials and capital. More labour effort is required to generate higher volume of output. Hence, the employment and use of overtime (OT) are the two relevant variables. Materials help to regulate output. The alternatives available to the company are inventories, back ordering or subcontracting of items.

These controllable variables constitute pure strategies by which fluctuations in demand and uncertainties in production activities can be accommodated by using the following steps:

1. *Vary the size or the workforce*: Output is controlled by hiring or laying off workers in proportion to changes in demand.
2. *Vary the hours worked*: Maintain the stable workforce, but permit idle time when there is a slack and permit overtime (OT) when demand is peak.
3. *Vary inventory levels*: Demand fluctuations can be met by large amount of inventory.
4. *Subcontract*: Upward shift in demand from low level. Constant production rates can be met by using subcontractors to provide extra capacity.

#### Aggregate Planning Guidelines

The following are the guidelines for aggregate planning:

1. Determine corporate policy regarding controllable variables.
2. Use a good forecast as a basis for planning.
3. Plan in proper units of capacity.
4. Maintain the stable workforce.
5. Maintain needed control over inventories.
6. Maintain flexibility to change.
7. Respond to demand in a controlled manner.
8. Evaluate planning on a regular base.

**5.8 MASTER PRODUCTION SCHEDULE (MPS)**

Master scheduling follows aggregate planning. It expresses the overall plans in terms of specific end items or models that can be assigned priorities. It is useful to plan for the material and capacity requirements.

Flowchart of aggregate plan and master production schedule is shown in Fig. 5.4

Time interval used in master scheduling depends upon the type, volume, and component lead times of the products being produced. Normally weekly time intervals are used. The time horizon covered by the master schedule also depends upon product characteristics and lead times. Some master schedules cover a period as short as few weeks and for some products it is more than a year.

**Functions of MPS**

Master Production Schedule (MPS) gives a formal details of the production plan and converts this plan into specific material and capacity requirements. The requirements with respect to labour, material and equipment is then assessed.

The main functions of MPS are:

1. *To translate aggregate plans into specific end items:* Aggregate plan determines level of operations that tentatively balances the market demands with the material, labour and equipment capabilities of the company. A master schedule translates this plan into specific number of end items to be produced in specific time period.

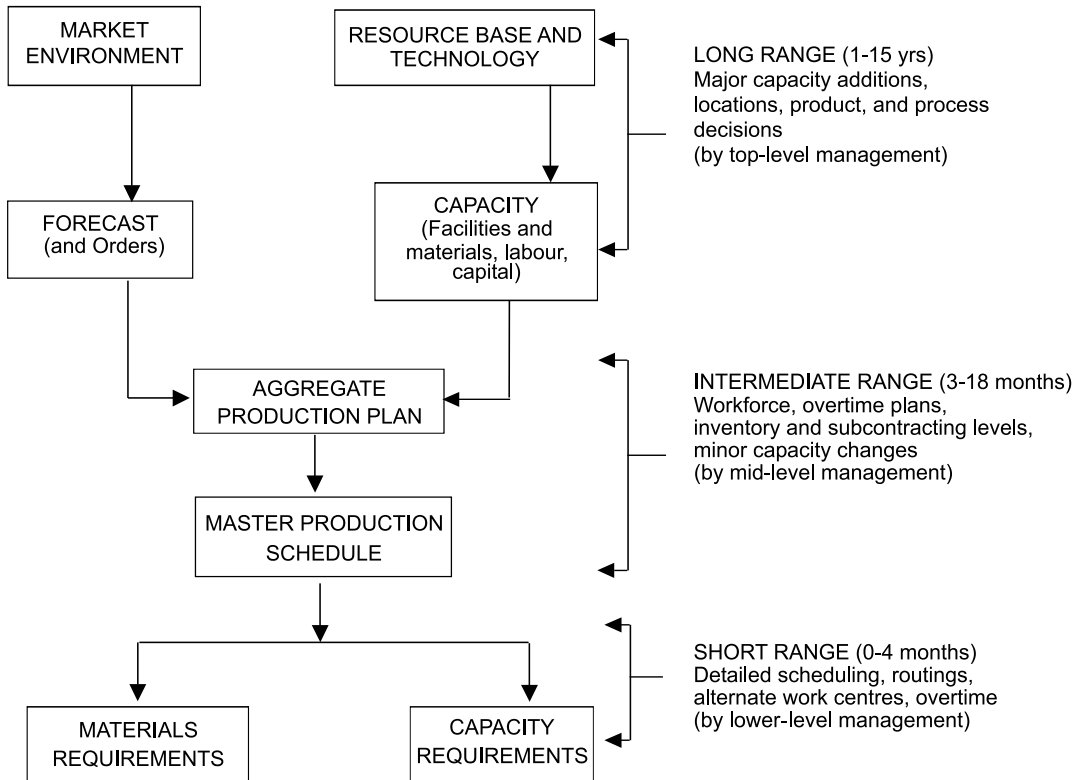

**Fig. 5.4** Flowchart of aggregate plan and master schedule

2. *Evaluate alternative schedules:* Master schedule is prepared by trial and error. Many computer simulation models are available to evaluate the alternate schedules.
3. *Generate material requirement:* It forms the basic input for material requirement planning (MRP).
4. *Generate capacity requirements:* Capacity requirements are directly derived from MPS. Master scheduling is thus a prerequisite for capacity planning.
5. *Facilitate information processing:* By controlling the load on the plant. Master schedule determines when the delivery should be made. It coordinates with other management information systems such as, marketing, finance and personnel.
6. *Effective utilization of capacity:* By specifying end item requirements schedule establishes the load and utilization requirements for machines and equipment.

## 5.9 MATERIAL REQUIREMENT PLANNING (MRP)

MRP refers to the basic calculations used to determine components required from end item requirements. It also refers to a broader information system that uses the dependence relationship to plan and control manufacturing operations.

*“Materials Requirement Planning (MRP) is a technique for determining the quantity and timing for the acquisition of dependent demand items needed to satisfy master production schedule requirements.”*

### 5.9.1 Objectives of MRP

1. **Inventory reduction:** MRP determines how many components are required when they are required in order to meet the master schedule. It helps to procure the materials/ components as and when needed and thus avoid excessive build up of inventory.

2. **Reduction in the manufacturing and delivery lead times:** MRP identifies materials and component quantities, timings when they are needed, availabilities and procurements and actions required to meet delivery deadlines. MRP helps to avoid delays in production and priorities production activities by putting due dates on customer job order.

3. **Realistic delivery commitments:** By using MRP, production can give marketing timely information about likely delivery times to prospective customers.

4. **Increased efficiency:** MRP provides a close coordination among various work centres and hence help to achieve uninterrupted flow of materials through the production line. This increases the efficiency of production system.

### 5.9.2 MRP System

The inputs to the MRP system are: (1) A master production schedule, (2) An inventory status file and (3) Bill of materials (BOM).

Using these three information sources, the MRP processing logic (computer programme) provides three kinds of information (output) for each product component: order release requirements, order rescheduling and planned orders.

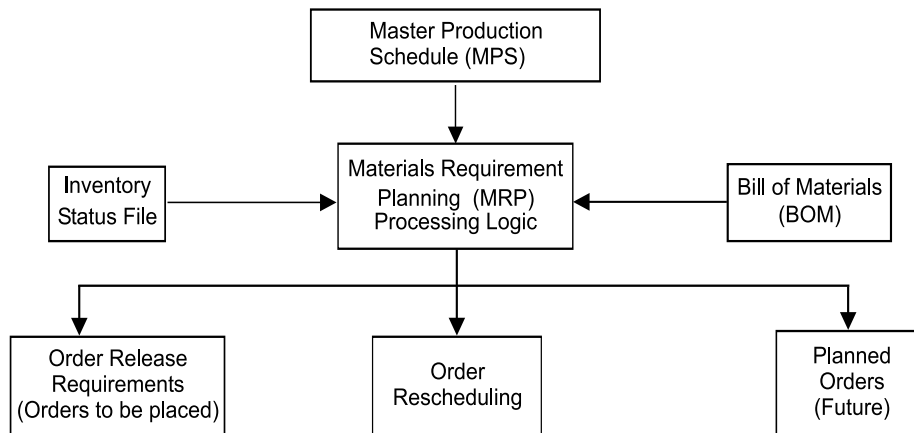

Fig. 5.5 MRP system

### 1. MASTER PRODUCTION SCHEDULE (MPS)

MPS is a series of time phased quantities for each item that a company produces, indicating how many are to be produced and when. MPS is initially developed from firm customer orders or from forecasts of demand before MRP system begins to operate. The MRP system whatever the master schedule demands and translates MPS end items into specific component requirements. Many systems make a simulated trial run to determine whether the proposed master can be satisfied.

### 2. INVENTORY STATUS FILE

Every inventory item being planned must have an inventory status file which gives complete and up to date information on the on-hand quantities, gross requirements, scheduled receipts and planned order releases for an item. It also includes planning information such as lot sizes, lead times, safety stock levels and scrap allowances.

### 3. BILL OF MATERIALS (BOM)

BOM identifies how each end product is manufactured, specifying all subcomponents items, their sequence of build up, their quantity in each finished unit and the work centres performing the build up sequence. This information is obtained from product design documents, workflow analysis and other standard manufacturing information.

## 5.10 CAPACITY PLANNING

Design of the production system involves planning for the inputs, conversion process and outputs of production operation. The effective management of capacity is the most important responsibility of production management. The objective of capacity management (*i.e.*, planning and control of capacity) is to match the level of operations to the level of demand.

**Capacity planning** is to be carried out keeping in mind future growth and expansion plans, market trends, sales forecasting, etc. It is a simple task to plan the capacity in case of stable demand. But in practice the demand will be seldom stable. The fluctuation of demand creates problems regarding the procurement of resources to meet the customer demand. Capacity decisions

are strategic in nature. Capacity is the rate of productive capability of a facility. Capacity is usually expressed as volume of output per period of time.

Production managers are more concerned about the capacity for the following reasons:

- Sufficient capacity is required to meet the customers demand in time.
- Capacity affects the cost efficiency of operations.
- Capacity affects the scheduling system.
- Capacity creation requires an investment.

Capacity planning is the first step when an organization decides to produce more or new products.

### 5.10.1 Measurement of Capacity Planning

The capacity of the manufacturing unit can be expressed in number of units of output per period. In some situations measuring capacity is more complicated when they manufacture multiple products. In such situations, the capacity is expressed as man-hours or machine hours. The relationship between capacity and output is shown in Fig. 5.6.

1. **Design capacity:** Designed capacity of a facility is the planned or engineered rate of output of goods or services under normal or full scale operating conditions.

For example, the designed capacity of the cement plant is 100 TPD (Tonnes per day). Capacity of the sugar factory is 150 tonnes of sugarcane crushing per day.

2. **System capacity:** System capacity is the maximum output of the specific product or product mix the system of workers and machines is capable of producing as an integrated whole. System capacity is less than design capacity or at the most equal, because of the limitation of product mix, quality specification, breakdowns. The actual is even less because of many factors affecting the output such as actual demand, downtime due to machine/equipment failure, unauthorised absenteeism.

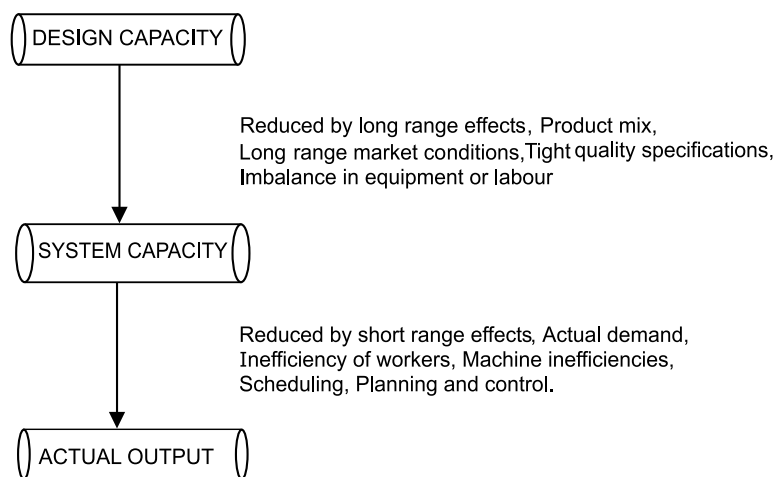

**Fig. 5.6** Capacity and output relationship

The system capacity is less than design capacity because of long range uncontrollable factors. The actual output is still reduced because of short-term effects such as, breakdown of equipment, inefficiency of labour. The system efficiency is expressed as ratio of actual measured output to the system capacity.

$$\text{System Efficiency (SE)} = \frac{\text{Actual output}}{\text{System capacity}}$$

3. **Licensed capacity:** Capacity licensed by the various regulatory agencies or government authorities. This is the limitation on the output exercised by the government.

4. **Installed capacity:** The capacity provided at the time of installation of the plant is called installed capacity.

5. **Rated capacity:** Capacity based on the highest production rate established by actual trials is referred to as rated capacity.

### 5.10.2 Process of Capacity Planning

Capacity planning is concerned with defining the long-term and the short-term capacity needs of an organization and determining how those needs will be satisfied. Capacity planning decisions are taken based upon the consumer demand and this is merged with the human, material and financial resources of the organization.

Capacity requirements can be evaluated from two perspectives—long-term capacity strategies and short-term capacity strategies.

#### 1. LONG-TERM CAPACITY STRATEGIES

Long-term capacity requirements are more difficult to determine because the future demand and technology are uncertain. Forecasting for five or ten years into the future is more risky and difficult. Even sometimes company's today's products may not be existing in the future. Long range capacity requirements are dependent on marketing plans, product development and life-cycle of the product. Long-term capacity planning is concerned with accommodating major changes that affect overall level of the output in long-term. Marketing environmental assessment and implementing the long-term capacity plans in a systematic manner are the major responsibilities of management. Following parameters will affect long range capacity decisions.

1. **Multiple products:** Company's produce more than one product using the same facilities in order to increase the profit. The manufacturing of multiple products will reduce the risk of failure. Having more than one product helps the capacity planners to do a better job. Because products are in different stages of their life-cycles, it is easy to schedule them to get maximum capacity utilisation.

2. **Phasing in capacity:** In high technology industries, and in industries where technology developments are very fast, the rate of obsolescence is high. The products should be brought into the market quickly. The time to construct the facilities will be long and there is no much time as the products should be introduced into the market quickly. Here the solution is phase in capacity on modular basis. Some commitment is made for building funds and men towards facilities over a period of 3–5 years. This is an effective way of capitalising on technological breakthrough.

3. **Phasing out capacity:** The outdated manufacturing facilities cause excessive plant



closures and down time. The impact of closures is not limited to only fixed costs of plant and machinery. Thus, the phasing out here is done with humanistic way without affecting the community. The phasing out options makes alternative arrangements for men like shifting them to other jobs or to other locations, compensating the employees, etc.

## 2. SHORT-TERM CAPACITY STRATEGIES

Managers often use forecasts of product demand to estimate the short-term workload the facility must handle. Managers looking ahead up to 12 months, anticipate output requirements for different products, and services. Managers then compare requirements with existing capacity and then take decisions as to when the capacity adjustments are needed.

For short-term periods of up to one year, fundamental capacity is fixed. Major facilities will not be changed. Many short-term adjustments for increasing or decreasing capacity are possible. The adjustments to be required depend upon the conversion process like whether it is capital intensive or labour intensive or whether product can be stored as inventory.

Capital intensive processes depend on physical facilities, plant and equipment. Short-term capacity can be modified by operating these facilities more or less intensively than normal. In labour intensive processes short-term capacity can be changed by laying off or hiring people or by giving overtime to workers. The strategies for changing capacity also depend upon how long the product can be stored as inventory.

The short-term capacity strategies are:

1. **Inventories:** Stock of finished goods during slack periods to meet the demand during peak period.
2. **Backlog:** During peak periods, the willing customers are requested to wait and their orders are fulfilled after a peak demand period.
3. **Employment level (hiring or firing):** Hire additional employees during peak demand period and layoff employees as demand decreases.
4. **Employee training:** Develop multi-skilled employees through training so that they can be rotated among different jobs. The multi-skilling helps as an alternative to hiring employees.
5. **Subcontracting:** During peak periods, hire the capacity of other firms temporarily to make the component parts or products.
6. **Process design:** Change job contents by redesigning the job.

## 5.11 ROUTING

Routing may be defined as the selection of path which each part of the product will follow while being transformed from raw materials to finished products. Path of the product will also give sequence of operation to be adopted while being manufactured.

In other way, routing means determination of most advantageous path to be followed from department to department and machine to machine till raw material gets its final shape, which involves the following steps:

- (a) Type of work to be done on product or its parts.
- (b) Operation required to do the work.
- (c) Sequence of operation required.

(d) Where the work will be done.

(e) A proper classification about the personnel required and the machine for doing the work.

For effective production control of a well-managed industry with standard conditions, the routing plays an important role, *i.e.*, to have the best results obtained from available plant capacity. Thus routing provides the basis for scheduling, dispatching and follow-up.

### 5.11.1 Techniques of Routing

While converting raw material into required goods different operations are to be performed and the selection of a particular path of operations for each piece is termed as 'Routing'. This selection of a particular path, *i.e.* sequence of operations must be the best and cheapest to have the lowest cost of the final product. The various routing techniques are:

1. **Route card:** This card always accompanies with the job throughout all operations. This indicates the material used during manufacturing and their progress from one operation to another. In addition to this the details of scrap and good work produced are also recorded.

2. **Work sheet:** It contains

(a) Specifications to be followed while manufacturing.

(b) Instructions regarding routing of every part with identification number of machines and work place of operation.

This sheet is made for manufacturing as well as for maintenance.

3. **Route sheet:** It deals with specific production order. Generally made from operation sheets. One sheet is required for each part or component of the order. These includes the following:

(a) Number and other identification of order.

(b) Symbol and identification of part.

(c) Number of pieces to be made.

(d) Number of pieces in each lot—if put through in lots.

(e) Operation data which includes:

(i) List of operation on the part.

(ii) Department in which operations are to be performed.

(iii) Machine to be used for each operation.

(iv) Fixed sequence of operation, if any.

(f) Rate at which job must be completed, determined from the operation sheet.

4. **Move order:** Though this is document needed for production control, it is never used for routing system. Move order is prepared for each operation as per operation sheet. On this the quantity passed forward, scrapped and to be rectified are recorded. It is returned to planning office when the operation is completed.

## 5.12 SCHEDULING

Scheduling can be defined as "prescribing of when and where each operation necessary to manufacture the product is to be performed."

It is also defined as "establishing of times at which to begin and complete each event or

operation comprising a procedure". The principle aim of scheduling is to plan the sequence of work so that production can be systematically arranged towards the end of completion of all products by due date.

### 5.12.1 Principles of Scheduling

1. **The principle of optimum task size:** Scheduling tends to achieve maximum efficiency when the task sizes are small, and all tasks of same order of magnitude.

2. **Principle of optimum production plan:** The planning should be such that it imposes an equal load on all plants.

3. **Principle of optimum sequence:** Scheduling tends to achieve the maximum efficiency when the work is planned so that work hours are normally used in the same sequence.

### 5.12.2 Inputs to Scheduling

1. *Performance standards:* The information regarding the performance standards (standard times for operations) helps to know the capacity in order to assign required machine hours to the facility.
2. Units in which loading and scheduling is to be expressed.
3. Effective capacity of the work centre.
4. Demand pattern and extent of flexibility to be provided for rush orders.
5. Overlapping of operations.
6. Individual job schedules.

### 5.12.3 Scheduling Strategies

Scheduling strategies vary widely among firms and range from 'no scheduling' to very sophisticated approaches.

These strategies are grouped into four classes:

1. **Detailed scheduling:** Detailed scheduling for specific jobs that are arrived from customers is impracticable in actual manufacturing situation. Changes in orders, equipment breakdown, and unforeseen events deviate the plans.

2. **Cumulative scheduling:** Cumulative scheduling of total work load is useful especially for long range planning of capacity needs. This may load the current period excessively and under load future periods. It has some means to control the jobs.

3. **Cumulative detailed:** Cumulative detailed combination is both feasible and practical approach. If master schedule has fixed and flexible portions.

4. **Priority decision rules:** Priority decision rules are scheduling guides that are used independently and in conjunction with one of the above strategies, *i.e.*, first come first serve. These are useful in reducing Work-In-Process (WIP) inventory.

**5.12.4 Types of Scheduling**

Types of scheduling can be categorized as forward scheduling and backward scheduling.

1. **Forward scheduling** is commonly used in job shops where customers place their orders on “needed as soon as possible” basis. Forward scheduling determines start and finish times of next priority job by assigning it the earliest available time slot and from that time, determines when the job will be finished in that work centre. Since the job and its components start as early as possible, they will typically be completed before they are due at the subsequent work centres in the routing. The forward method generates in the process inventory that are needed at subsequent work centres and higher inventory cost. Forward scheduling is simple to use and it gets jobs done in shorter lead times, compared to backward scheduling.

2. **Backward scheduling** is often used in assembly type industries and commit in advance to specific delivery dates. Backward scheduling determines the start and finish times for waiting jobs by assigning them to the latest available time slot that will enable each job to be completed just when it is due, but done before. By assigning jobs as late as possible, backward scheduling minimizes inventories since a job is not completed until it must go directly to the next work centre on its routing. Forward and backward scheduling methods are shown in Fig. 5.7.

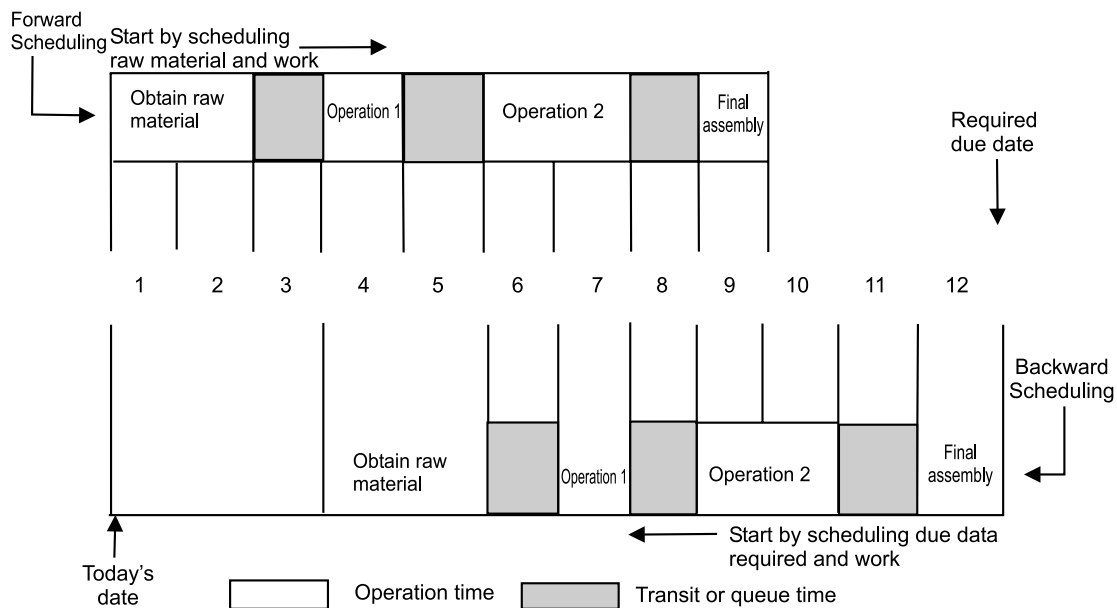

**Fig. 5.7** Forward and backward scheduling

**5.13 SCHEDULING METHODOLOGY**

The scheduling methodology depends upon the type of industry, organization, product, and level of sophistication required. They are:

1. Charts and boards,

2. Priority decision rules, and
3. Mathematical programming methods.

### 1. Gantt Charts and Boards

Gantt charts and associated scheduling boards have been extensively used scheduling devices in the past, although many of the charts are now drawn by computer. Gantt charts are extremely easy to understand and can quickly reveal the current or planned situation to all concerned. They are used in several forms, namely,

- (a) Scheduling or progress charts, which depicts the sequential schedule;
- (b) Load charts, which show the work assigned to a group of workers or machines; and
- (c) Record a chart, which are used to record the actual operating times and delays of workers and machines.

### 2. Priority Decision Rules

Priority decision rules are simplified guidelines for determining the sequence in which jobs will be done. In some firms these rules take the place of priority planning systems such as MRP systems. Following are some of the priority rules followed.

<i>Symbol</i>	<i>Priority rule</i>
FCFS	First come, first served
EDO	Earliest due date
LS	Least slack (that is, time due less processing time)
SPT	Shortest processing time
LPT	Longest processing time
PCO	Preferred customer order
RS	Random selection

### 3. Mathematical Programming Methods

Scheduling is a complex resource allocation problem. Firms process capacity, labour skills, materials and they seek to allocate their use so as to maximize a profit or service objective, or perhaps meet a demand while minimizing costs.

The following are some of the models used in scheduling and production control.

(a) **Linear programming model:** Here all the constraints and objective functions are formulated as a linear equation and then problem is solved for optimality. *Simplex method*, *transportation methods* and *assignment method* are major methods used here.

(b) **PERT/CPM network model:** PERT/CPM network is the network showing the sequence of operations for a project and the precedence relation between the activities to be completed.

**Note:** Scheduling is done in all the activities of an organisation *i.e.*, production, maintenance etc. Therefore, all the methods and techniques of scheduling is used for maintenance management (Ref. Chapter 8).

## EXERCISES

### Section A

1. What do you mean by production planning and control?
2. What do you mean by aggregate planning?
3. What is master production schedule?
4. What is material requirement planning?
5. What is capacity planning?
6. What is routing?
7. What is scheduling?
8. Mention the types of scheduling.

### Section B

1. Why do you need production planning and control?
2. What are the objective of production planning and control?
3. What are the guidelines for aggregate planning?
4. Explain the functions of master production schedule.
5. Explain the objective of MRP.
6. How do you measure capacity?
7. Explain the techniques of routing.
8. What are the inputs to scheduling?
9. Explain the scheduling strategies.

### Section C

1. Discuss the phases of production planning and control.
2. Discuss the functions of PP & C.
3. Discuss the operations planning and scheduling systems.
4. Discuss the aggregate plan and master schedule.
5. Discuss the MRP system.
6. Discuss the process of capacity planning.
7. Discuss the scheduling methods.

### Skill Development

**FAST FOOD RESTAURANT VISIT:** Get the information for the following questions:

1. Phase of production planning and production control.
2. Planning for the demand fluctuation.
3. Items are prepared to order or with forecast.
4. Procedures to manufacture pizza.
5. Scheduling the orders (i.e. first come first schedule or largest proceeding time and shortest proceeding time etc.)

### CASELET

#### ESCOM-COPING WITH RUNWAY CAPACITY NEEDS

ESCOM is a producer of electronic home appliances, including VHS (Video Home System) television recorders, located in northern California. The packaged product weighs about 75 kg. ESCOM was not the innovator of the system. Rather, its managers sat back and let RCA and others develop the market, and ESCOM is currently producing under license agreements. ESCOM has a conscious strategy of being a follower with new product innovations. It does not have the financial resources to be a leader in research and development.

ESCOM's present opportunity is indicated by the fact that industry sales of VHS recorders have increased 30 per cent per year for the past two years, and forecasts for the next year and the two following are even more enticing. ESCOM has established a 10 per cent market share position and feels that it can at least maintain this position if it has the needed capacity; it could possibly improve its market share if competitors fail to provide capacity at the time it is needed.

	Year					
	0	1	2	3	4	5
Forecast, 1000 Units	100	140	195	270	350	450
Capacity (gap), or slack 1000 units	5	(35)	(90)	(165)	(245)	(345)

The forecasts and capacity gaps are indicated in Table. ESCOM regards the first year forecast as being quite solid, based on its present market share and a compilation of several industry forecasts from different sources. It is less sure about the forecasts for future years, but it is basing these forecasts on patterns for both black and white and color TV sales during their product life cycles.

ESCOM's VHS model has a factory price of Rs 600. Variable costs are 70 percent of the price. Inventory carrying costs are 20 per cent of inventory value, 15 percentage points of which represents the cost of capital. ESCOM's facility planners estimate that a 40,000 unit plant can be built for Rs. 5 million and a 200,00 unit plant, for Rs. 10 million. Land and labour are available in the area, and either size plant can be built within a year.

- (a) What capacity plans do you think ESCOM should make for next year? Why?
- (b) What longer-term capacity plans should ESCOM make? Why?
- (c) What are the implications of these plans for marketing, distribution, and production?

[Source: *Modern Production/Operations Management* by Elwood S. Buffa & Rakesh K. Sarin]

# 6

## QUALITY CONTROL

### CHAPTER OUTLINE

- |  |  |
|--|--|
| 6.1 <i>Introduction</i>                | 6.7 <i>Quality Circles</i>                         |
| 6.2 <i>Quality</i>                     | 6.8 <i>Total Quality Management (TQM)</i>          |
| 6.3 <i>Control</i>                     | 6.9 <i>ISO 9000 Series</i>                         |
| 6.4 <i>Inspection</i>                  | 6.10 <i>Application ISO 9000: ISO 14000 Series</i> |
| 6.5 <i>Quality Control</i>             | • <i>Exercises</i>                                 |
| 6.6 <i>Statistical Process Control</i> | • <i>Skill Development</i>                         |
|  | • <i>Caselet</i>                                   |

### 6.1 INTRODUCTION

In any business organization, profit is the ultimate goal. To achieve this, there are several approaches. Profit may be maximized by cutting costs for the same selling price per unit. If it is a monopolistic business, without giving much of importance to the cost reduction programs, the price may be fixed suitably to earn sufficient profit. But, to survive in a competitive business environment, goods and services produced by a firm should have the minimum required quality. Extra quality means extra cost. So, the level of quality should be decided in relation to other factors such that the product is well absorbed in the market. In all these cases, to have repeated sales and thereby increased sales revenue, basic quality is considered to be one of the supportive factors. Quality is a measure of how closely a good or service conforms to specified standard.

Quality standards may be any one or a combination of attributes and variables of the product being manufactured. The attributes will include performance, reliability, appearance, commitment to delivery time, etc., variables may be some measurement variables like, length, width, height, diameter, surface finish, etc.



Most of the above characteristics are related to products. Similarly, some of the quality characteristics of services are meeting promised due dates, safety, comfort, security, less waiting time and so forth. So, the various dimensions of quality are performance, features, reliability, conformance, durability, serviceability, aesthetics, perceived quality, safety, comfort, security, commitment to due dates, less waiting time, etc.

## 6.2 QUALITY

Different meaning could be attached to the word quality under different circumstances. The word quality does not mean the quality of manufactured product only. It may refer to the quality of the process (*i.e.*, men, material, and machines) and even that of management. Where the quality manufactured product referred as or defined as “Quality of product as the degree in which it fulfills the requirement of the customer. It is not absolute but it judged or realized by comparing it with some standards”.

Quality begins with the design of a product in accordance with the customer specification further it involved the established measurement standards, the use of proper material, selection of suitable manufacturing process etc., quality is a relative term and it is generally used with reference to the end use of the product.

Crosby defined as “Quality is conformance to requirement or specifications”.

Juran defined as “Quality is fitness for use”. “The Quality of a product or service is the fitness of that product or service for meeting or exceeding its intended use as required by the customer.”

### 6.2.1 Fundamental Factors Affecting Quality

The nine fundamental factors (**9 M's**), which are affecting the quality of products and services, are: markets, money, management, men, motivation, materials, machines and mechanization. Modern information methods and mounting product requirements.

1. **Market:** Because of technology advancement, we could see many new products to satisfy customer wants. At the same time, the customer wants are also changing dynamically. So, it is the role of companies to identify needs and then meet it with existing technologies or by developing new technologies.

2. **Money:** The increased global competition necessitates huge outlays for new equipments and process. This should be rewarded by improved productivity. This is possible by minimizing quality costs associated with the maintenance and improvements of quality level.

3. **Management:** Because of the increased complex structure of business organization, the quality related responsibilities lie with persons at different levels in the organization.

4. **Men:** The rapid growth in technical knowledge leads to development of human resource with different specialization. This necessitates some groups like, system engineering group to integrate the idea of full specialization.

5. **Motivation:** If we fix the responsibility of achieving quality with each individual in the organization with proper motivation techniques, there will not be any problem in producing the designed quality products.

6. **Materials:** Selection of proper materials to meet the desired tolerance limit is also an important consideration. Quality attributes like, surface finish, strength, diameter etc., can be obtained by proper selection of material.

7. **Machines and mechanization:** In order to have quality products which will lead to higher productivity of any organization, we need to use advanced machines and mechanize various operations.

8. **Modern information methods:** The modern information methods help in storing and retrieving needed data for manufacturing, marketing and servicing.

9. **Mounting product requirements:** Product diversification to meet customers taste leads to intricacy in design, manufacturing and quality standards. Hence, companies should plan adequate system to tackle all these requirements.

## 6.3 CONTROL

The process through which the standards are established and met with standards is called control. This process consists of observing our activity performance, comparing the performance with some standard and then taking action if the observed performance is significantly too different from the standards.

The control process involves a universal sequence of steps as follows:

1. Choose the control object
2. Choose a unit of measure
3. Set the standard value
4. Choose a sensing device which can measure
5. Measure actual performance
6. Interpret the difference between actual and standard
7. Taking action.

### 6.3.1 Need for Controlling Quality

In the absence of quality, the following will result:

1. No yardstick for comparing the quality of goods/services.
2. Difficulty in maintaining consistency in quality.
3. Dissatisfied customers due to increased maintenance and operating costs of products/services.
4. Increased rework cost while manufacturing products/providing services.
5. Reduced life time of the products/services.
6. Reduced flexibility with respect to usage of standard spare parts.
7. Hence, controlling quality is an essential activity.

## 6.4 INSPECTION

Inspection is an important tool to achieve quality concept. It is necessary to assure confidence to manufacturer and aims satisfaction to customer. Inspection is an indispensable tool of modern manufacturing process. It helps to control quality, reduces manufacturing costs, eliminate scrap losses and assignable causes of defective work.

The inspection and test unit is responsible for appraising the quality of incoming raw materials and components as well as the quality of the manufactured product or service. It checks the components at various stages with reference to certain predetermined factors and detecting and sorting out the faulty or defective items. It also specified the types of inspection devices to use and the procedures to follow to measure the quality characteristics.

Inspection only measures the degree of conformance to a standard in the case of variables. In the case of attributes inspection merely separates the nonconforming from the conforming. Inspection does not show why the nonconforming units are being produced.

Inspection is the most common method of attaining standardization, uniformity and quality of workmanship. It is the cost art of controlling the production quality after comparison with the established standards and specifications. It is the function of quality control. If the said item does not fall within the zone of acceptability it will be rejected and corrective measure will be applied to see that the items in future conform to specified standards.

### 6.4.1 Objectives of Inspection

1. To detect and remove the faulty raw materials before it undergoes production.
2. To detect the faulty products in production whenever it is detected.
3. To bring facts to the notice of managers before they become serious to enable them discover weaknesses and over the problem.
4. To prevent the substandard reaching the customer and reducing complaints.
5. To promote reputation for quality and reliability of product.

### 6.4.2 Purpose of Inspection

1. To distinguish good lots from bad lots.
2. To distinguish good pieces from bad pieces.
3. To determine if the process is changing.
4. To determine if the process is approaching the specification limits.
5. To rate quality of product.
6. To rate accuracy of inspectors.
7. To measure the precision of the measuring instrument.
8. To secure products-design information.
9. To measure process capability.

### 6.4.3 Types of Inspection

Types of inspection are:

1. Floor inspection
2. Centralized inspection
3. Combined inspection
4. Functional inspection
5. First piece inspection
6. Pilot piece inspection
7. Final inspection

#### 1. FLOOR INSPECTION

In this system, the inspection is performed at the place of production. It suggests the checking of materials in process at the machine or in the production time by patrolling inspectors. These inspectors move from machine to machine and from one to the other work centres. Inspectors have to be highly skilled. This method of inspection minimize the material handling, does not disrupt the line layout of machinery and quickly locate the defect and readily offers field and correction.

#### Advantages

1. Detection of errors of the source reduces scrap and rework.
2. Correction is done before it affects further production, resulting in saving cost of unnecessary work on defective parts.
3. Material handling time is reduced.
4. Job satisfaction to worker as he can't be held responsible for bad work at a later date.
5. Greater number of pieces can be checked than a sample size.
6. Does not delay in production.

#### Disadvantages

1. Delicate instruments can be employed.
2. Measuring or inspection equipment have to be recalibrated often as they are subjected to wear or dust.
3. High cost of inspection because of numerous sets of inspections and skilled inspectors.
4. Supervision of inspectors is difficult due to vibration.
5. Pressure on inspector.
6. Possibility of biased inspection because of worker.

#### Suitability

1. Heavy products are produced.
2. Different work centres are integrated in continuous line layout.

#### 2. CENTRALISED INSPECTION

Inspection is carried in a central place with all testing equipment, sensitive equipment is housed in air-conditioned area. Samples are brought to the inspection floor for checking. Centralised inspection may locate in one or more places in the manufacturing industry.

**Advantages**

1. Greater degree of inspection due to sensitive equipment.
2. Less number of inspectors and tools.
3. Equipment needs less frequency of recalibration.
4. Cost of inspection is reduced.
5. Unbiased inspection.
6. Supervision of inspectors made possible.
7. No distraction to the inspector.

**Disadvantages**

1. Defects of job are not revealed quickly for prevention.
2. Greater material handling.
3. High cost as products are subjected to production before they are prevented.
4. Greater delay in production.
5. Inspection of heavy work not possible.
6. Production control work is more complicated.
7. Greater scrap.

**3. COMBINED INSPECTION**

Combination of two methods whatever may be the method of inspection, whether floor or central. The main objective is to locate and prevent defect which may not repeat itself in subsequent operation to see whether any corrective measure is required and finally to maintain quality economically.

**4. FUNCTIONAL INSPECTION**

This system only checks for the main function, the product is expected to perform. Thus an electrical motor can be checked for the specified speed and load characteristics. It does not reveal the variation of individual parts but can assure combined satisfactory performance of all parts put together. Both manufacturers and purchasers can do this, if large number of articles are needed at regular intervals. This is also called assembly inspection.

**5. FIRST PIECE OR FIRST-OFF INSPECTIONS**

First piece of the shift or lot is inspected. This is particularly used where automatic machines are employed. Any discrepancy from the operator as machine tool can be checked to see that the product is within in control limits. Excepting for need for precautions for tool we are check and disturbance in machine set up, this yields good result if the operator is careful.

**6. PILOT PIECE INSPECTION**

This is done immediately after new design or product is developed. Manufacturer of product is done either on regular shop floor if production is not disturbed. If production is affected to a large extent, the product is manufactured in a pilot plant. This is suitable for mass production and products involving large number of components such as automobiles aeroplanes etc., and modification are design or manufacturing process is done until satisfactory performance is assured or established.

## 7. FINAL INSPECTION

This is also similar to functional or assembly inspection. This inspection is done only after completion of work. This is widely employed in process industries where there is not possible such as, electroplating or anodizing products. This is done in conjunction with incoming material inspection.

### 6.4.4 Methods of Inspection

There are two methods of inspection. They are: 100% inspection and sampling inspection.

#### 1. 100% INSPECTION

This type will involve careful inspection in detail of quality at each strategic point or stage of manufacture where the test is involved is non-destructive and every piece is separately inspected. It requires more number of inspectors and hence it is a costly method. There is no sampling error. This is subjected to inspection error arising out of fatigue, negligence, difficulty of supervision etc. Hence, complete accuracy of influence is seldom attained. It is suitable only when a small number of pieces are there or a very high degree of quality is required. Example: Jet engines, aircraft, medical and scientific equipment.

#### 2. SAMPLING INSPECTION

In this method randomly selected samples are inspected. Samples taken from different patches of products are representatives. If the sample proves defective, the entire concerned is to be rejected or recovered. Sampling inspection is cheaper and quicker. It requires less number of Inspectors. It is subjected to sampling errors but the magnitude of sampling error can be estimated. In the case of destructive test, random or sampling inspection is desirable. This type of inspection governs wide currency due to the introduction of automatic machines or equipments which are less susceptible to chance variable and hence require less inspection, suitable for inspection of products which have less precision importance and are less costly. Example: Electrical bulbs, radio bulbs, washing machine etc.

### 6.4.5 Drawbacks of Inspection

Following are the disadvantages of inspection:

1. Inspection adds to the cost of the product but not for its value.
2. It is partially subjective, often the inspector has to judge whether a products passes or not.
3. Fatigue and Monotony may affect any inspection judgment.
4. Inspection merely separates good and bad items. It is no way to prevent the production of bad items.

## 6.5

## QUALITY CONTROL

Quality Control (QC) may be defined as a system that is used to maintain a desired level of quality in a product or service. It is a systematic control of various factors that affect the quality of the product. It depends on materials, tools, machines, type of labour, working conditions etc.

QC is a broad term, it involves inspection at particular stage but mere inspection does not mean QC. As opposed to inspection, in quality control activity emphasis is placed on the quality future production. Quality control aims at prevention of defects at the source, relies on effective feedback system and corrective action procedure. Quality control uses inspection as a valuable tool.

According to Juran “Quality control is the regulatory process through which we measure actual quality performance, compare it with standards, and act on the difference”. Another definition of quality control is from ANSI/ASQC standard (1978) quality control is defined as “The operational techniques and the activities which sustain a quality of product or service that will satisfy given needs; also the use of such techniques and activities”.

Alford and Beatty define QC as “In the broad sense, quality control is the mechanism by which products are made to measure up to specifications determined from customers, demands and transformed into sales engineering and manufacturing requirements, it is concerned with making things right rather than discovering and rejecting those made wrong”.

### 6.5.1 Types of Quality Control

QC is not a function of any single department or a person. It is the primary responsibility of any supervisor to turn out work of acceptable quality. Quality control can be divided into three main sub-areas, those are:

1. Off-line quality control, 2. Statistical process control, and 3. Acceptance sampling plans.

1. **Off-line quality control:** Its procedure deal with measures to select and choose controllable product and process parameters in such a way that the deviation between the product or process output and the standard will be minimized. Much of this task is accomplished through product and process design.

*Example:* Taguchi method, principles of experimental design etc.

2. **Statistical process control:** SPC involves comparing the output of a process or a service with a standard and taking remedial actions in case of a discrepancy between the two. It also involves determining whether a process can produce a product that meets desired specification or requirements. On-line SPC means that information is gathered about the product, process, or service while it is functional. The corrective action is taken in that operational phase. This is real-time basis.

3. **Acceptance sampling plans:** A plan that determines the number of items to sample and the acceptance criteria of the lot, based on meeting certain stipulated conditions (such as the risk of rejecting a good lot or accepting a bad lot) is known as an acceptance sampling plan.

### 6.5.2 Steps in Quality Control

Following are the steps in quality control process:

1. Formulate quality policy.
2. Set the standards or specifications on the basis of customer's preference, cost and profit.
3. Select inspection plan and set up procedure for checking.
4. Detect deviations from set standards of specifications.
5. Take corrective actions or necessary changes to achieve standards.

6. Decide on salvage method *i.e.*, to decide how the defective parts are disposed of, entire scrap or rework.
7. Coordination of quality problems.
8. Developing quality consciousness both within and outside the organization.
9. Developing procedures for good vendor-vendee relations.

### 6.5.3 Objectives of Quality Control

Following are the objectives of quality control:

1. To improve the companies income by making the production more acceptable to the customers, *i.e.*, by providing long life, greater usefulness, maintainability etc.
2. To reduce companies cost through reduction of losses due to defects.
3. To achieve interchangeability of manufacture in large scale production.
4. To produce optimal quality at reduced price.
5. To ensure satisfaction of customers with productions or services or high quality level, to build customer goodwill, confidence and reputation of manufacturer.
6. To make inspection prompt to ensure quality control.
7. To check the variation during manufacturing.

The broad areas of application of quality control are incoming material control, process control and product control.

### 6.5.4 Benefits of Quality Control

- Improving the quality of products and services.
- Increasing the productivity of manufacturing processes, commercial business, corporations.
- Reducing manufacturing and corporate costs.
- Determining and improving the marketability of products and services.
- Reducing consumer prices of products and services.
- Improving and/or assuring on time deliveries and availability.
- Assisting in the management of an enterprise.

### 6.5.5 Seven Tools for Quality Control

To make rational decisions using data obtained on the product, or process, or from the consumer, organizations use certain graphical tools. These methods help us learn about the characteristics of a process, its operating state of affairs and the kind of output we may expect from it. Graphical methods are easy to understand and provide comprehensive information; they are a viable tool for the analysis of product and process data. These tools are effect on quality improvement. The seven quality control tools are:

1. Pareto charts
2. Check sheets
3. Cause and effect diagram
4. Scatter diagrams
5. Histogram
6. Graphs or flow charts
7. Control charts



## 1. PARETO CHARTS

Pareto charts help prioritize by arranging them in decreasing order of importance. In an environment of limited resources these diagrams help companies to decide on the order in which they should address problems. The Pareto analysis can be used to identify the problem in a number of forms.

- (a) Analysis of losses by material (number or part number).
- (b) Analysis of losses by process *i.e.*, classification of defects or lot rejections in terms of the process.
- (c) Analysis of losses by product family.
- (d) Analysis by supplier across the entire spectrum of purchases.
- (e) Analysis by cost of the parts.
- (f) Analysis by failure mode.

**Example:** The Fig. 6.1 shows a Pareto chart of reasons for poor quality. Poor design will be the major reason, as indicated by 64%. Thus, this is the problem that the manufacturing unit should address first.

- |                        |                          |
|------------------------|--------------------------|
| A — Poor Design        | B — Defective Parts      |
| C — Operator Error     | D — Wrong Dimensions     |
| E — Surface Abrasion   | F — Machine Calibrations |
| G — Defective Material |                          |

## 2. CHECK SHEETS

Check sheets facilitate systematic record keeping or data collection observations are recorded as they happen which reveals patterns or trends. Data collection through the use of a checklist is often the first step in analysis of quality problem. A checklist is a form used to record the frequency of occurrence of certain product or service characteristics related to quality. The characteristics may be measurable on a continuous scale such as weight, diameter, time or length.

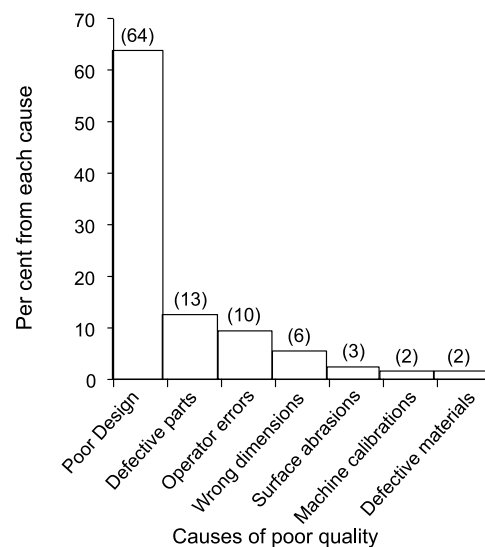

**Fig. 6.1** Pareto chart

**Example:** The table is a check sheet for an organization’s computer related problems.

COMPONENTS REPLACED BY LAB	
TIME PERIOD: 22 Feb, to 27 Feb, 2005	
REPAIR TECHNICIAN: XYZ	
TV SET MODEL 1013	
Integrated Circuits	
Capacitors	
Resistors	
Transformers	
Commands	
CRT	

**Fig. 6.2 Checklist**

**3. CAUSE AND EFFECT DIAGRAM**

It is sometimes called as Fish-bone diagram. It is first developed by Kaorv Ishikawa in 1943 and is sometimes called as Ishikawa diagram. The diameter helps the management trace customer complaints directly to the operations involved. The main quality problem is referred to Fish-head; the major categories of potential cause structural bones and the likely specific causes to ribs. It explores possible causes of problems, with the intention being to discover the root causes. This diagram helps identify possible reasons for a process to go out of control as well as possible effects on the process.

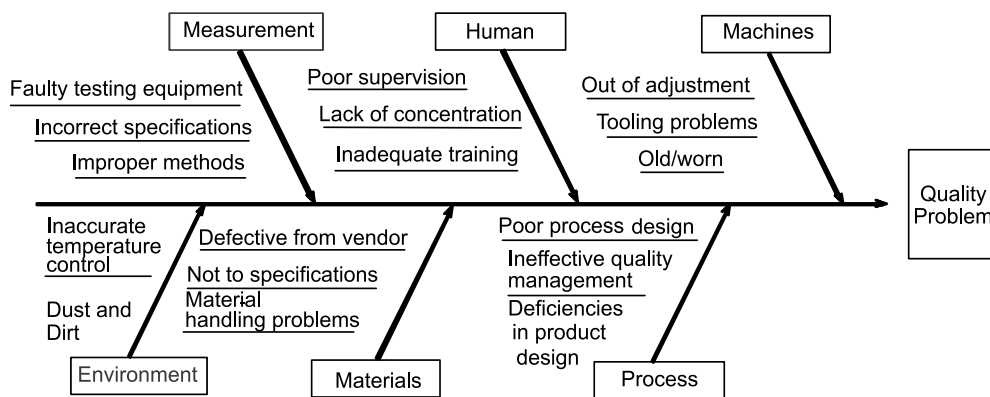

**Fig. 6.3 Fishbone diagram**

**4. SCATTER DIAGRAM (SCATTER PLOTS)**

It often indicates the relationship between two variables. They are often used as follow-ups to a cause and effect analysis to determine whether a stated cause truly does impact the quality characteristics.

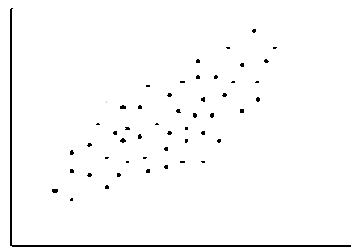
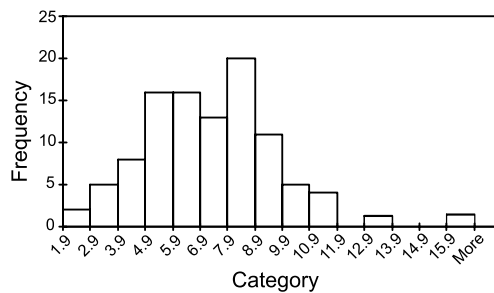

**Fig. 6.4** Scatter diagram

**Example:** The above figure plots advertising expenditure against company sales and indicates a strong positive relationship between the two variables. As the level of advertising expenditure increases sales tend to increase.

**5. HISTOGRAM (OR) BAR CHARTS**

It displays the large amounts of data that are difficult to interpret in their raw form. A histogram summarizes data measured on a continuous scale showing the frequency distribution of some quality characteristics (in statistical terms the central tendency and the dispersion of the data).

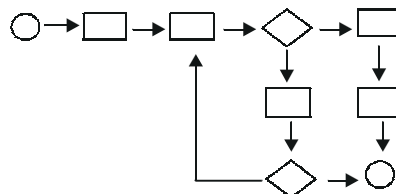

**Fig. 6.5** Histogram

Often the mean of the data is indicated on the histogram. A bar chart is a series of bare representing the frequency of occurrence of data characteristics, the bar height indicates the number of times a particular quality characteristic was observed.

**6. FLOW CHARTS (OR) GRAPHS**

It shows the sequence of events in a process. They are used for manufacturing and service operations. Flow charts are often used to diagram operational procedures to simplify the system. They can identify bottlenecks, redundant steps and non-value added activities. A realistic flow chart can be constructed by using the knowledge of the person who are directly involved in the particular process. The flow chart can be identifies where delays can occur.

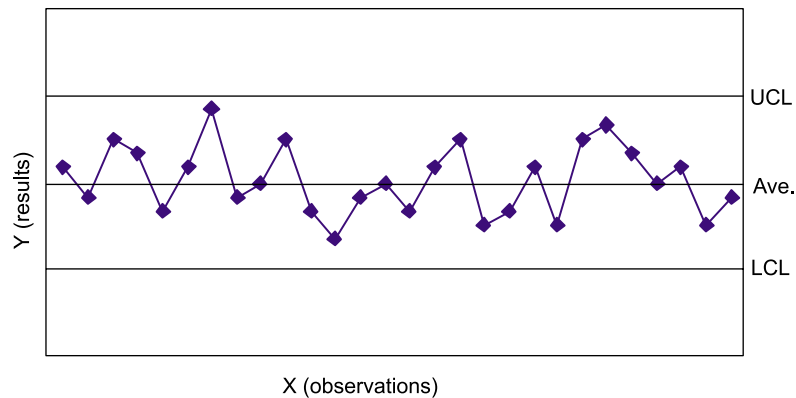

**Fig. 6.6** Flowchart

## 7. CONTROL CHARTS

It distinguishes special causes of variations from common causes of variation. They are used to monitor and control process on an ongoing basis. A typical control chart plots a selected quality characteristic found from sub-group of observations as a function of sample number. Characteristics such as sample average, sample range and sample proportion of non-conforming units are plotted. The centre line on a control chart represents the average value of characteristics being plotted. Two limits known as the upper control limit (UCL) and lower control limit (LCL) are also shown on control charts. These limits are constructed so that if the process is operating under a stable system of chance causes, the probability of an observation falling outside these limits is quite small. Figure 6.7 shows a generalized representation of a control chart.

Control chart shows the performance of a process from two points of view. *First*, they show a snapshot of the process at the moment the data are collected. *Second*, they show the process trend as time progresses. Process trends are important because they help in identifying the out-of-control status if it actually exists. Also, they help to detect variations outside the normal operational limits, and to identify the cause of variations. Fig. 6.7 shows a generalised representation of a control chart.



**Fig. 6.7** Control charts

### 6.5.6 Causes of Variation in Quality

The variation in the quality of product in any manufacturing process is broadly classified as:

- (a) Chance causes
- (b) Assignable causes.

#### (A) CHANCE CAUSES

The chance causes are those causes which are inherited in manufacturing process by virtue of operational and constructional features of the equipments involved in a manufacturing process.

This is because of—

1. Machine vibrations
2. Voltage variations
3. Composition variation of material, etc.

They are difficult to trace and difficult to control, even under best condition of production. Even though, it is possible to trace out, it is not economical to eliminate. The chance causes results in only a minute amount of variation in process. Variation in chance causes is due to internal factors only the general pattern of variation under chance causes will follow a stable statistical distribution (normal distribution). Variation within the control limits means only random causes are present.

### (B) ASSIGNABLE CAUSES

These are the causes which creates ordinary variation in the production quality.

Assignable cause's variation can always be traced to a specific quality. They occur due to—

1. Lack of skill in operation
2. Wrong maintenance practice
3. New vendors
4. Error in setting jigs and fixtures
5. Raw material defects

Variation due to these causes can be controlled before the defective items are produced. Any one assignable cause can result in a large amount of variation in process. If the assignable causes are present, the system will not follow a stable statistical distribution. When the actual variation exceeds the control limits, it is a signal that assignable causes extend the process and process should be investigated.

## 6.6

### STATISTICAL PROCESS CONTROL

Statistical process control (SPC) is the application of statistical techniques to determine whether the output of a process conforms to the product or service design. It aims at achieving good quality during manufacture or service through prevention rather than detection. It is concerned with controlling the process that makes the product because if the process is good then the product will automatically be good.

#### 6.6.1 Control Charts

SPC is implemented through control charts that are used to monitor the output of the process and indicate the presence of problems requiring further action. Control charts can be used to monitor processes where output is measured as either *variables* or *attributes*. There are two types of control charts: Variable control chart and attribute control chart.

1. **Variable control charts:** It is one by which it is possible to measures the quality characteristics of a product. The variable control charts are **X-BAR** chart, **R-BAR** chart, **SIGMA** chart.

2. **Attribute control chart:** It is one in which it is not possible to measures the quality characteristics of a product, *i.e.*, it is based on visual inspection only like good or bad, success or failure, accepted or rejected. The attribute control charts are **p-charts**, **np-charts**, **c-charts**, **u-charts**. It requires only a count of observations on characteristics *e.g.*, the number of non-conforming items in a sample.

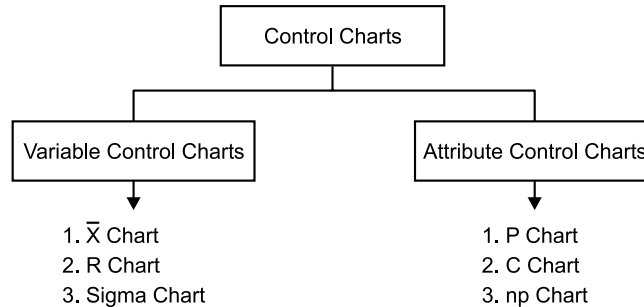

**Fig. 6.8** Control charts

### CHARACTERISTICS OF CONTROL CHARTS

A control chart is a time-ordered diagram to monitor a quality characteristic, consisting of:

1. A nominal value, or centre line, the average of several past samples.
2. Two control limits used to judge whether action is required, an upper control limit (UCL) and a lower control limit (LCL).
3. Data points, each consisting of the average measurement calculated from a sample taken from the process, ordered overtime. By the Central Limit Theorem, regardless of the distribution of the underlying individual measurements, the distribution of the sample means will follow a normal distribution. The control limits are set based on the sampling distribution of the quality measurement.

### BENEFITS OF USING CONTROL CHARTS

Following are the benefits of control charts:

1. A control chart indicates when something may be wrong, so that corrective action can be taken.
2. The patterns of the plot on a control chart diagnosis possible cause and hence indicate possible remedial actions.
3. It can estimate the process capability of process.
4. It provides useful information regarding actions to take for quality improvement.

### OBJECTIVES OF CONTROL CHARTS

Following are the objectives of control charts:

1. To secure information to be used in establishing or changing specifications or in determining whether the process can meet specifications or not.
2. To secure information to be used on establishing or changing production procedures.
3. To secure information to be used on establishing or changing inspection procedures or acceptance procedures or both.
4. To provide a basis for current decision during production.

5. To provide a basis for current decisions on acceptance for rejection of manufacturing or purchased product.
6. To familiarize personnel with the use of control chart.

### CONTROL CHARTS FOR VARIABLES

As the name indicates, these charts will use variable data of a process. X chart given an idea of the central tendency of the observations. These charts will reveal the variations between sample observations. R chart gives an idea about the spread (dispersion) of the observations. This chart shows the variations within the samples.

**X-Chart and R-Chart:** The formulas used to establish various control limits are as follows:

#### (a) Standard Deviation of the Process, $\sigma$ , Unknown

*R-Chart:* To calculate the range of the data, subtract the smallest from the largest measurement in the sample.

The control limits are: 
$$UCL_R = D_4 \bar{R} \text{ and } LCL_R = D_3 \bar{R}$$

where  $\bar{R}$  = average of several past  $R$  values and is the central line of the control chart, and

$D_3, D_4$  = constants that provide three standard deviation (three-sigma) limits for a given sample size

*$\bar{X}$ -Chart:* The control limits are:

$$UCL_{\bar{X}} = \bar{\bar{X}} + A_2 \bar{R} \text{ and } LCL_{\bar{X}} = \bar{\bar{X}} - A_2 \bar{R}$$

where  $\bar{\bar{X}}$  = central line of the chart and the average of past sample mean's, and  $A_2$  = constant to provide three-sigma limits for the process mean.

#### (b) Standard Deviation of the Process, $\sigma$ , Known

Control charts for variables (with the standard deviation of the process,  $\sigma$ , known) monitor the mean,  $\bar{X}$ , of the process distribution.

The control limits are:

$$UCL = \bar{\bar{X}} + 2\sigma_{\bar{X}}$$

and 
$$LCL = \bar{\bar{X}} - 2\sigma_{\bar{X}}$$

where  $\bar{\bar{X}}$  = centre line of the chart and the average of several past sample means,  $Z$  is the standard normal deviate (number of standard deviations from the average),

$\sigma_{\bar{X}} = \sigma / \sqrt{n}$  and is the standard deviation of the distribution of sample means, and  $n$  is the sample size

*Procedures to construct X-chart and R-chart*

1. Identify the process to be controlled.

2. Select the variable of interest.
3. Decide a suitable sample size ( $n$ ) and number of samples to be collected ( $k$ ).
4. Collect the specified number of samples over a given time interval.
5. Find the measurement of interest for each piece within the sample.
6. Obtain mean ( $\bar{X}$ ) of each sample.
7. Establish control limits for  $\bar{X}$  and  $R$ -charts.

**CONTROL CHARTS FOR ATTRIBUTES**

P-charts and C-charts are charts will used for attributes. This chart shows the quality characteristics rather than measurements.

**P-CHART**

A  $p$ -chart is a commonly used control chart for attributes, whereby the quality characteristic is counted, rather than measured, and the entire item or service can be declared good or defective.

The standard deviation of the proportion defective,  $p$ , is:

$\sigma_p = \sqrt{\bar{p}(1-\bar{p})/n}$ , where  $n$  = sample size, and  $\bar{p}$  = average of several past  $p$  values and central line on the chart.

Using the normal approximation to the binomial distribution, which is the actual distribution of  $p$ ,

$$UCL_p = \bar{p} + Z\sigma_p$$

and

$$LCL_p = \bar{p} - Z\sigma_p$$

where  $z$  is the normal deviate (number of standard deviations from the average).

**ILLUSTRATIONS ON X BAR CHART AND R BAR CHART**

**(i) Standard Deviation of the Process,  $\Sigma$ , Unknown**

**ILLUSTRATION 1:** Several samples of size  $n = 8$  have been taken from today's production of fence posts. The average post was 3 yards in length and the average sample range was 0.015 yard. Find the 99.73% upper and lower control limits.

**SOLUTION:**

$$\bar{\bar{X}} = 3 \text{ yds}$$

$$\bar{\bar{R}} = 0.015 \text{ yds}$$

$$A_2 = 0.37 \text{ from Statistical Table}$$

$$UCL = \bar{\bar{X}} + A_2\bar{\bar{R}} = 3 + 0.37(0.015) = 3.006 \text{ yds}$$

$$LCL = \bar{\bar{X}} - A_2\bar{\bar{R}} = 3 - 0.37(0.015) = 2.996 \text{ yds}$$

**ILLUSTRATION 2 (Problem on  $\bar{X}$  and  $R$  Chart):** The results of inspection of 10 samples with its average and range are tabulated in the following table. Compute the control limit for the  $\bar{X}$  and  $R$ -chart and draw the control chart for the data.



Sample No. (Sample Size 5)	$\bar{X}$ (Mean)	R (Range)
1	7.0	2
2	7.5	3
3	8.0	2
4	10.0	2
5	9.5	3
6	11.0	4
7	11.5	3
8	4.0	2
9	3.5	3
10	4.0	2
$\Sigma \bar{X} = 76$		$\Sigma R = 26$

**SOLUTION:**

$$\bar{\bar{X}} = \Sigma \bar{X} / \text{No. of samples}$$

$$\bar{R} = \Sigma R / \text{No. of samples}$$

Therefore, 
$$\bar{\bar{X}} = \frac{76}{10} = 7.6$$

$$\bar{R} = \frac{26}{10} = 2.6$$

For  $\bar{X}$  chart

$$\text{Upper Control Limit (UCL)} = \bar{\bar{X}} + A_2 \bar{R}$$

$$\text{Lower Control Limit (LCL)} = \bar{\bar{X}} - A_2 \bar{R}$$

For  $\bar{R}$  chart

$$\text{Upper Control Limit (UCL)} = D_4 \bar{R}$$

$$\text{Lower Control Limit (LCL)} = D_3 \bar{R}$$

The values of various factors (like  $A_2$ ,  $D_4$  and  $D_3$ ) based on normal distribution can be found from the following table:

$$A_2 = 0.58, D_3 = 0 \text{ and } D_4 = 2.11$$

Thus, for  $\bar{X}$  chart

$$\text{UCL} = 7.6 + (0.58 \times 2.6)$$

$$= 7.6 + 1.51 = 9.11$$

$$LCL = 7.6 - (0.58 \times 2.6) = 6.09$$

For R chart

$$UCL = 2.11 \times 2.6 = 5.48$$

$$LCL = D_3 \times \bar{R} = 0 \times \bar{R} = 0$$

These control limits are marked on the graph paper on either side of the mean value (line).  $\bar{X}$  and R values are plotted on the graph and jointed, thus resulting the control chart.

From the  $\bar{X}$  chart, it appears that the process became completely out of control for 4th sample over labels.

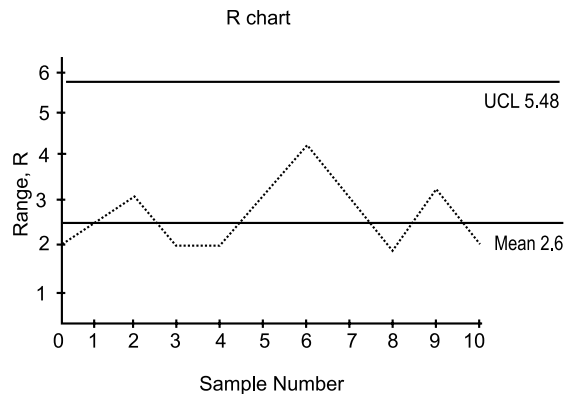
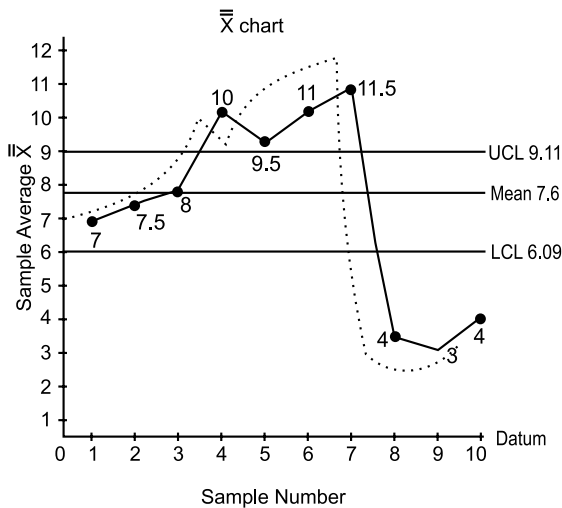

**(ii) Standard Deviation of the Process,  $\sigma$ , known**

**ILLUSTRATION 3:** Twenty-five engine mounts are sampled each day and found to have an average width of 2 inches, with a standard deviation of 0.1 inche. What are the control limits that include 99.73% of the sample means ( $z = 3$ )?

**SOLUTION:**  $UCL_{\bar{X}} = \bar{\bar{X}} + Z\sigma_{\bar{X}} = 2 + 3\left(0.1/\sqrt{25}\right) = 2 + 0.06 = 2.06$  inches

$$LCL_{\bar{X}} = \bar{\bar{X}} - Z\sigma_{\bar{X}} = 2 - 3\left(0.1/\sqrt{25}\right) = 2 - 0.06 = 1.94$$
 inches

**ILLUSTRATION 4 (Problem on p-Chart):** The following are the inspection results of 10 lots, each lot being 300 items. Number defectives in each lot is 25, 30, 35, 40, 45, 35, 40, 30, 20 and 50. Calculate the average fraction defective and three sigma limit for P-chart and state whether the process is in control.

**SOLUTION:**

<i>Date</i>	<i>Number of pieces inspected</i> (a)	<i>Number of defective pieces found</i> (b)	<i>Fraction defective</i> $p = (b)/(a)$	<i>% Defective loop</i>
November 4	300	25	0.0834	8.34
November 5	300	30	0.1000	10.00
November 6	300	35	0.1167	11.67
November 7	300	40	0.1333	13.33
November 8	300	45	0.1500	15.00
November 10	300	35	0.1167	11.67
November 11	300	40	0.1333	13.33
November 12	300	30	0.1000	10.00
November 13	300	20	0.0666	6.66
November 14	300	50	0.1666	16.66
Total Number = 10	3000	350		

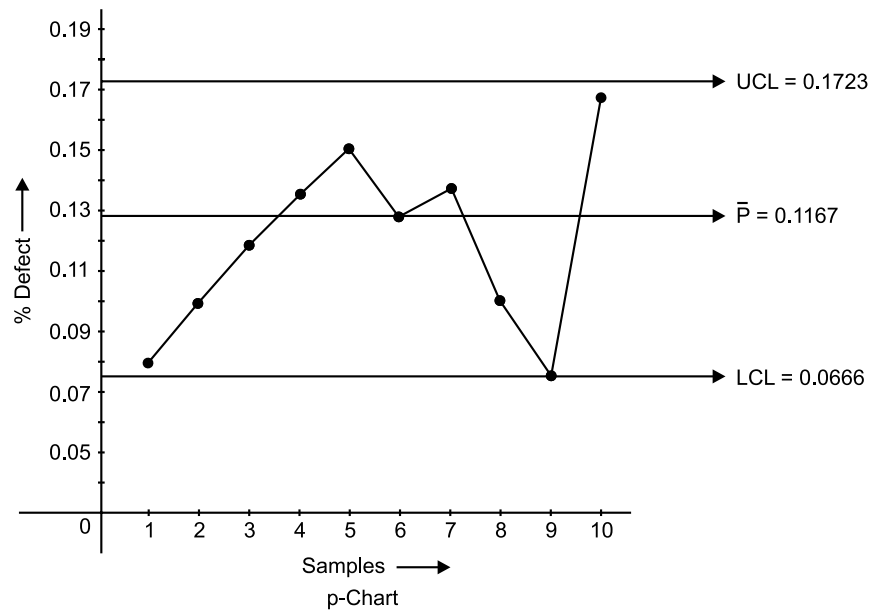

$$\text{Upper Control Limit, UCL} = \bar{p} + 3\sqrt{\frac{\bar{P}(1-\bar{P})}{n}}$$

$$\text{Lower Control Limit, LCL} = \bar{p} - 3\sqrt{\frac{\bar{p}(1-\bar{p})}{n}}$$

where 
$$\bar{p} = \frac{\text{Total number of defective pieces found}}{\text{Total number of pieces inspected}}$$

$$\bar{p} = \frac{350}{3000} = \mathbf{0.1167}$$

and 
$$n = \text{number of pieces inspected every day} = 300$$

Therefore, 
$$\sqrt{\frac{\bar{p}(1-\bar{p})}{n}} = \sqrt{\frac{0.1167 \times (1-0.1167)}{300}}$$

$$= \sqrt{\frac{0.1167 \times 0.8333}{300}} = \mathbf{0.01852}$$

and 
$$3 \cdot \sqrt{\frac{\bar{p}(1-\bar{p})}{n}} = 0.01852 \times 3 = \mathbf{0.05556}$$

Thus, 
$$\text{UCL} = 0.1167 + 0.05556 = 0.17226 = 0.1723 \text{ (Approx.)}$$

$$\text{LCL} = 0.1167 - 0.05556 = 0.06114 = 0.0611 \text{ (Approx.)}$$

**Conclusion:** All the samples are within the control limit and we can say process is under control.

**TYPES OF SAMPLING ERRORS**

There are two types of errors. They are type-I and type-II that can occur when making inferences from control chart.

**Type-I: Error or  $\alpha$ -error or Level of Significance**

Reject the hypothesis when it is true.

This results from inferring that a process is out of control when it is actually in control. The probability of type-I error is denoted by  $\alpha$ , suppose a process is in control. If a point on the control chart falls outside the control limits, we assume that, the process is out of control. However, since the control limits are a finite distance ( $3\sigma$ ) from the mean. There is a small chance about 0.0026 of a sample falling outside the control limits. In such instances, inferring the process is out of control is wrong conclusion.

The control limits could be placed sufficiently far apart say 4 or  $5\sigma$  stand deviations on each side of the central lines to reduce the probability of type-I error.

**Type-II: Error or  $\beta$ -error**

Accept the hypothesis when it is false.

This results from inferring that a process is in control when it is really out of control. If no observations for outside the control limits we conclude that the process is in control while in reality it is out control. For example, the process mean has changed.

The process could get out of control because process variability has changed (due to presence of new operator). As the control limits are placed further apart the probability of type-II error increases. To reduce the probability of type-II error it tends to have the control limits placed closer to each other. This increases the probability of type-I error. Thus, the two types of errors are inversely related to each other as the control limits change. Increasing the sample size can reduce both  $\alpha$  and  $\beta$ .

### 6.6.2 Acceptance Sampling

The objective of acceptance sampling is to take decision whether to accept or reject a lot based on sample's characteristics. The lot may be incoming raw materials or finished parts.

An accurate method to check the quality of lots is to do 100% inspection. But, 100% inspection will have the following limitations:

- The cost of inspection is high.
- Destructive methods of testing will result in 100% spoilage of the parts.
- Time taken for inspection will be too long.
- When the population is large or infinite, it would be impossible or impracticable to inspect each unit.

Hence, acceptance-sampling procedure has lot of scope in practical application. Acceptance sampling can be used for attributes as well as variables.

Acceptance sampling deals with accept or reject situation of the incoming raw materials and finished goods. Let the size of the incoming lot be  $N$  and the size of the sample drawn be  $n$ . The probability of getting a given number of defective goods parts out a sample consisting of  $n$  pieces will follow binomial distribution. If the lot size is infinite or very large, such that when a sample is drawn from it and not replaced, then the usage of binomial distribution is justified. Otherwise, we will have to use hyper-geometric distribution.

Specifications of a single sampling plan will contain a sample size ( $n$ ) and an acceptance number  $C$ . As an example, if we assume the sample size as 50 and the acceptance number as 3, the interpretation of the plan is explained as follows: Select a sample of size 50 from a lot and obtain the number of defective pieces in the sample. If the number of defective pieces is less than or equal to 3, then accept the whole lot from which the sample is drawn. Otherwise, reject the whole lot. This is called single sampling plan. There are several variations of this plan.

In this process, one will commit two types of errors, *viz.*, type-I error and type-II error. If the lot is really good, but based on the sample information, it is rejected, then the supplier/producer will be penalized. This is called producer's risk or type-I error. The notation for this error is  $\alpha$ . On the other hand, if the lot is really bad, but it is accepted based on the sample information, then the customer will be at loss. This is called consumer's risk or type-II error. The notation for this error is  $\beta$ . So, both parties should jointly decide about the levels of producer's risk ( $\alpha$ ) and consumer's risk ( $\beta$ ) based on mutual agreement.

#### OPERATING CHARACTERISTIC CURVE (O.C. CURVE)

The concepts of the two types of risk are well explained using an operating characteristic curve. This curve will provide a basis for selecting alternate sample plans. For a given value of sample size ( $n$ ), acceptance number ( $C$ ), the O.C. curve is shown in Fig. 6.8.

In Fig. 6.9, per cent defective is shown on  $x$ -axis. The probability of accepting the lot for given per cent defective is shown on  $y$ -axis. The value for per cent defective indicates the quality level of the lot inspected. AQL means acceptable quality level and LTPD indicates lot tolerance per cent defectives. These represent quality levels of the lot submitted for inspection. If the quality level of the lot inspected is at AQL or less than AQL, then the customers are satisfied with the quality of the lot. The corresponding probability of acceptance is called  $1 - \alpha$ . On the other hand, if the quality level is more than or equal to LTPD, the quality of the lot is considered to be inferior from consumer's viewpoint. The corresponding probability of acceptance of the lot is called  $\beta$ . The quality levelling between AQL and LTPD is called indifferent zone.

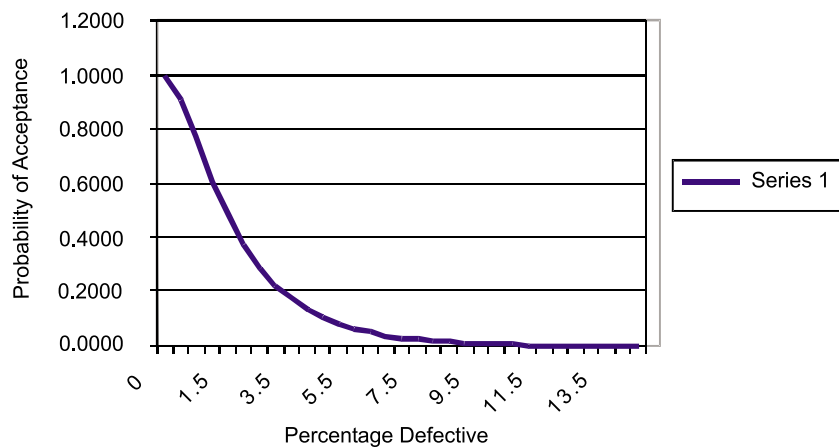

Fig. 6.9 Operating characteristic curve

So, we require  $\alpha$ ,  $\beta$ , AQL and LTPD to design a sample plan. Based on these, one can determine  $n$  and  $C$  for the implementation purpose of the plan.

Fig. 6.10 shows a various O.C. curves for different combinations of  $n$  and  $C$ .

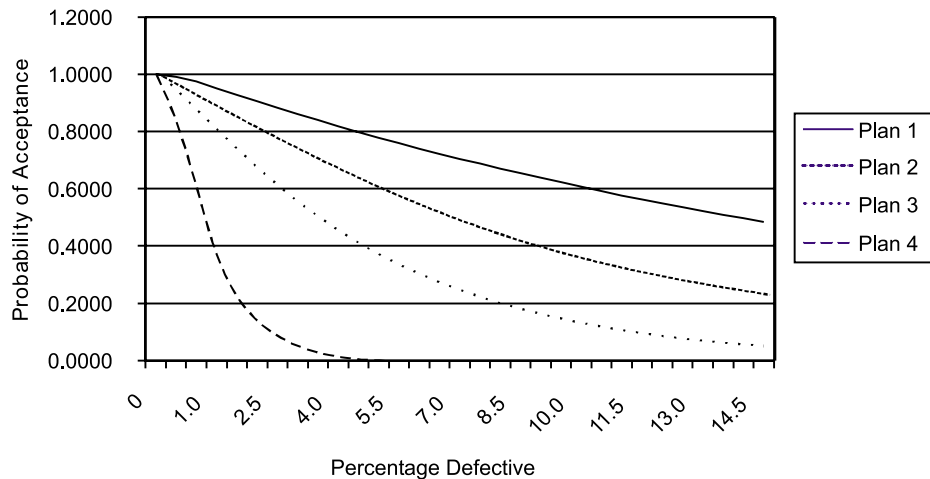

Fig. 6.10 Operation characteristic curve for different samples.

### SINGLE SAMPLING PLAN

The design of single sampling plan with a specified producer's risk and consumer's risk is demonstrated in this section. The required data for designing such plan are as follows:

- (a) Producer's Risk ( $\alpha$ )
- (b) Consumer's Risk ( $\beta$ )
- (c) Acceptable Quality Level (AQL)
- (d) Lot Tolerance Per cent Defectives (LTPD)

The objective of this design is to find out the values for the sample size ( $n$ ) and acceptance number ( $C$ ). The values for  $n$  and  $C$  are to be selected such that the O.C. curve passes through the following two coordinates:

- Coordinate with respect to the given  $\alpha$  and AQL.
- Coordinate with respect to the given  $\beta$  and LTPD.

But, the values of  $n$  and  $C$  should be integers. So, it will be very difficult to find  $n$  and  $C$  exactly for the given parameters of the design. Hence, we will have to look for approximate integer values for  $n$  and  $C$  such that the O.C. curve more or less passes through the above two coordinates.

## 6.7 QUALITY CIRCLES

The quality circles began in Japan in 1960s. The concept of quality circles is based on the participating style of management. It assumes that productivity will improve through an uplift of morale and motivations which are in turn achieved through consultation and discussion in informal groups. One organizational mechanism for worker participation in quality is the quality circle. It is typically an informal group of people that consists of operators, supervisors, managers and so on who get together to improve ways to make the product or deliver the service.

According to Juran, quality circle defined as "a group of work force level people, usually from within one department, who volunteer to meet weekly (on company time) to address quality problems that occur within their department."

Quality circle members select the problems and are given training in problem-solving techniques. A quality circle can be an effective productivity improvement tool because it generates new ideas and implements them. Where the introduction of quality circle is carefully planned and where the company environment is supporting they are highly successful.

The benefits fall into two categories: those are measurable saving and improvement in the attitudes and behaviour of people. Quality circles pursue two types of problems, those concerned with the personal well being of the worker and those concerned with the well being of company.

### 6.7.1 Benefits of QC

The most important benefit of quality circles is their effect on people's attitudes fall into three categories:

### 1. Quality Circles Effect on Individual Characteristics

- (a) Quality circles enable the individual to improve personal capabilities—group participation and learning specific problem-solving tools.
- (b) Quality circles increase the individual's self-respect.
- (c) Quality circles help worker change certain personality characteristics—shy person become as active.

### 2. Quality Circles Effect on Individuals Relations with Other

- (a) Quality circles increase the respect of the supervisor for the worker.
- (b) Quality circles increase workers understanding of the difficulties faced by supervisors—problem selection, solving and implementations.
- (c) Quality circle increase management's respect for worker.

### 3. Quality Circles Effect on Workers and Their Attributes

- (a) Quality circles change some workers negative attitudes.
- (b) Quality circle reduces conflict stemming from the working environment.
- (c) Quality circles help workers to understand better the reasons while many problems solved quickly.

Quality circles, as a **management tool**, are based on the following basic principles of people:

- (a) People want to do a good job.
- (b) People want to be recognized as intelligent, interested employees and to participate in decisions affecting their work.
- (c) People want information to better understand goals and problems of their organization and make informed decisions.
- (d) Employees want recognition and responsibility and a feeling of self-esteem.

Motivational methods are not enough for successful quality circle programs. Management support, technical knowledge, and statistical procedures are essential.

## 6.8

## TOTAL QUALITY MANAGEMENT

Now-a-days, customers demand products/services with greater durability and reliability at the most economic price. This forces producers to strictly follow quality procedures right from design till shipment and installation of the products. So that goal of any competitive industry is to provide a product or service at the most economical costs, ensuring full customer satisfaction. This can be achieved through Total Quality Management (TQM), because, quality is not a technical function, but a systemic process extending throughout all phases of the business, *e.g.*, marketing, design, development, engineering, purchasing, production/operations.

As per Feigebaum, "*Total Quality Management* is an effective system of integrating the quality development, quality maintenance and quality improvement efforts of various groups in an organization so as to enable marketing, engineering, production and service at the most economical levels which allow for full customer satisfaction".



### 6.8.1 Benefits of TQM

The benefits of TQM can be classified into the following two categories:

1. Customer satisfaction oriented benefits.
2. Economic improvements oriented benefits.

1. **Customer satisfaction oriented benefits:** The benefits under this category are listed below:

- (a) Improvement in product quality.
- (b) Improvement in product design.
- (c) Improvement in production flow.
- (d) Improvement in employee morale and quality consciousness.
- (e) Improvement of product service.
- (f) Improvement in market place acceptance.

2. **Economic improvements oriented benefits:** The benefits under this category are as follows:

- (a) Reductions in operating costs.
- (b) Reductions in operating losses.
- (c) Reductions in field service costs.
- (d) Reductions in liability exposure.

## 6.9 ISO 9000 SERIES

ISO stands for International Organization for Standardization. It is an international body, which consists of representatives from more than 90 countries. The national standard bodies of these countries are the members of this organization. Bureau of Indian Standards (BIS) are the Indian representative to ISO, ISO and International Electro Technical Commission (IEC) operate jointly as a single system. These are non-governmental organizations, which exist to provide common standards on international trade of goods and services.

ISO 9000 standards expect firms to have a quality manual that meets ISO guidelines, documents, quality procedures and job instructions, and verification of compliance by third-party auditors. ISO 9000 series has five international standards on quality managements. They are:

1. ISO 9000 — Quality management and Quality assurance standards
2. ISO 9001 — Quality systems: Quality in design
3. ISO 9002 — Quality systems: Production and Installation
4. ISO 9003 — Quality systems: Final inspection and test
5. ISO 9004 — Quality management and systems

### 6.9.1 Objectives of ISO 9000 Series

The objectives of ISO 9000 series is listed in Table 6.1.

**TABLE 6.1: ISO 9000 series**

<i>Standard</i>	<i>Objectives/Tasks</i>
ISO 9000	This provides guidelines on selection and use of quality management and quality assurance standards.
ISO 9001	It has 20 elements covering design, development, production, installation and servicing.
ISO 9002	It has 18 elements covering production and installation. It is same as ISO 9001 without the first two tasks, viz., design and development. This is applicable for the units excluding R & D functions.
ISO 9003	It has 12 elements covering final inspection and testing for laboratories and warehouses etc.
ISO 9004	This provides guidelines to interpret the quality management and quality assurance. This also has suggestions which are not mandatory.

**6.9.2 Benefits of ISO 9000 Series**

ISO 9000 series provides several tangible and intangible benefits which are listed below:

1. This gives competitive advantage in the global market.
2. Consistency in quality, since ISO helps in detecting non-conformity early which makes it possible to take corrective action.
3. Documentation of quality procedures adds clarity to quality system.
4. ISO 9000 ensures adequate and regular quality training for all members of the organization.
5. ISO helps the customers to have cost effective purchase procedure.
6. The customers while making purchases from companies with ISO certificate need not spend much on inspection and testing. This will reduce the quality cost and lead-time.
7. This will help in increasing productivity.
8. This will aid to improved morale and involvement of workers.
9. The level of job satisfaction would be more.

**6.9.3 Steps in ISO 9000 Registration**

1. Selection of appropriate standard from ISO 9001, ISO 9002 and ISO 9003 using the guidelines given in ISO 9000.
  2. Preparation of quality manual to cover all the elements in the selected model.
  3. Preparation of procedures and shop floor instructions which are used at the time of implementing the system. Also document these items.
  4. Self-auditing to check compliance of the selected model.
  5. Selection of a registrar and making application to obtain certificate for the selected model.
- A registrar is an independent body with knowledge and experience to evaluate any one of the three models of the company’s quality system (ISO 9002). Registrars are approved and certified by acridities.

The registrar, on successful verification and assessment will register the company. Before selecting a registrar, one should know the following:

1. Accreditors of the registrar.
2. Background and credibility of the registrar.
3. Cost of registration through the proposed registrar.
4. Expected harmony between the company and the potential registrar while working towards implementing ISO model in the company.

## **6.10 APPLICATION ISO 9000: ISO 14000 SERIES**

### **OVERVIEW**

The ISO 14000 series of environmental management standards are intended to assist organizations manage the environmental effect of their business practices. The ISO 14000 series is similar to the ISO 9000 series published in 1987. The purpose of the ISO 9000 series is to encourage organizations to institute quality assurance management programs. Although ISO 9000 deals with the overall management of an organization and ISO 14000 deals with the management of the environmental effects of an organization, both standards are concerned with processes, and there is talk of combining the two series into one.

Both series of standards were published by ISO, the International Organization for Standardization. The purpose of ISO is to facilitate international trade and cooperation in commercial, intellectual, scientific and economic endeavors by developing international standards. ISO originally focused on industrial and mechanical engineering standards. Now, it has ventured into setting standards for an organization's processes, policies, and practices.

The environmental standards of ISO 14000 deal with how a company manages the environment inside its facilities and the immediate outside environment. However, the standards also call for analysis of the entire life cycle of a product, from raw material to eventual disposal. These standards do not mandate a particular level of pollution or performance, but focus on awareness of the processes and procedures that can effect the environment. It should be noted that adherence to the ISO 14000 standards does not in anyway release a company from any national or local regulations regarding specific performance issues regarding the environment.

Some of the standards in the ISO 14000 series are:

- ISO 14001—Specification of Environmental Management Systems
- ISO 14004—Guideline Standard
- ISO 14010 through ISO 14015—Environmental Auditing and Related Activities
- ISO 14020 through ISO 14024—Environmental Labelling
- ISO 14031 through ISO 14032—Environmental Performance Evaluation
- ISO 14040 through ISO 14043—Life Cycle Assessment
- ISO 14050—Terms and Definitions

Although the ISO 14000 standards are similar to the ISO 9000 standards, the nature of the environmental standards creates a need for people who are technical environment professionals in addition to those required to maintain the documentation necessary for certification.

### 6.10.1 The Benefits of ISO 14000 Certification

The benefits of acquiring ISO certification go beyond the satisfaction of doing a good deed. Adhering to the standard may result in better conformance to environmental regulations, greater marketability, better use of resources, higher quality goods and services, increased levels of safety, improved image and increased profits.

- The environmental awareness and the documentation that are required by the ISO 14000 standards assist a company in conforming to environmental regulations. This means that a company, by diligently adhering to the standard, is less likely to violate environmental regulations and is always ready for inspection by a regulatory agency. In addition, the certification and documentation may aid a company in acquiring capital, in defending itself during environmental litigation and in receiving insurance or permits.
- A wider market for a company's goods and services may result from certification. Many corporations and governments will be looking for suppliers that are ISO 14000 certified in order to maintain their own certification and environment-friendly image.
- Producers of consumer goods may find that many consumers not only try to purchase goods from environment-friendly companies, but will spend a little more if they feel they are helping the environment. In order to reap this benefit, a company must make their environmental efforts known through advertising and labelling.
- The process analyses that go along with ISO 14000 certification may result in streamlining processes and more efficient use of resources and raw materials and subsequently reduce a company's costs.
- Reducing the amount of potentially dangerous substances in an end product may result in less use of dangerous chemicals in a plant. This leads to a safer internal environment for employees and the possibility of reduced insurance premiums. Improved employee morale may result when employees feel that the workplace is safer and they are contributing to the environmental effort.

## ANNEXURE-I

### List of Certifying Bodies

The list of certification bodies with Quality Management System and Environmental Management System for 9000 series is listed in the following tables:

**List of Certification Bodies for Quality Management Systems:**

Accrn. No.	Name	Address	Website & Phone
QM001	Det Norske Veritas AS (Certification Services, India)	203, Savitri Sadan 1, 11, Preet Vihar Community Centre, New Delhi-110 092 India	www.dnv.com Tel +91 11 2202 3242 Fax +91 11 2202 3244
QM002	TUV India Pvt. Ltd.	801, Raheja Plaza - I, L.B.S Marg, Ghatkopar (West), Mumbai - 400 086	www.tuvindia.co.in Tel + 91 22 6647 7000 Fax + 91 22 6647 7009
QM003	Bureau Veritas Certification (India) Pvt. Ltd.	Marwah Centre, 6th Floor, Opposite Ansa Industrial Estate, Kishanlal Marwah Marg, Off Sakivihar Road, Andheri, East, Mumbai-400 072	www.certification.bureauv eritas.co.in Tel +91 22 6695 6330 Fax +91 22 6695 6302
QM004	Intal Quality Certification Pvt. Ltd.	Platinum City, G / 13 / 03, Site No. 02, Next to CMTI, HMT Road, Yeshwantpur Post Bangalore - 560 022	www.i-quality.net Tel +91 80 4117 2752 Fax +91 80 4128 0347
QM006	Indian Register Quality Systems (IRQS) Dept. of Indian Register of Shipping	161 A, Maker Towers 'E' (16th Floor), Cuffe Parade, Mumbai - 400 005	www.irclass.org Tel +91 22 2215 3871 / 2215 4162 / 2215 4164 Fax +91 22 2215 4250
QM007	ICRS Management Systems Private Ltd.	808, Suneja Tower - II, District Centre, Janakpuri, New Delhi 110058	www.icrsm.com Tel +91 11 3290 6779 Fax +91 11 2554 2745
QM008	British Standards Institution (BSI Management Systems India Pvt. Ltd.)	The Mira Corporate Suites (A-2), Plot 1&2, Ishwar Nagar, Mathura Road, New Delhi - 110 065	www.bsi-global.com Tel +91 11 2692 9000 (eight lines) Fax +91 11 2692 9001
QM010	TUV Rheinland (India) Private Limited	504-506, Prestige Centre Point Cunningham Road Bangalore - 560 002	www.ind.tuv.com +91 80 22282489 / 90
QM011	TUV South Asia Private Limited	321, Solitaire Corporate Park, Chakala, Andheri (East) Mumbai - 400 093	www.tuv-sud.in www.tuvsouthasia.com Tel +91 22 6692 3415 Fax +91 22 6692 3418
QM012	NVT Quality Certification Pvt. Ltd.	CAP-1, EOIZ, Export Promotion Industrial Park, Near ITPL, Whitefield, Bangalore - 560 066, India	www.nvtqualitygroup.org Tel +91-80-5534 3536/ 37 Fax +91-80-2841 6767
QM014	American Quality Assessors (India) Private Limited	"Victory Vihar", 4th Floor, Himayatnagar, Hyderabad - 500 029 (India)	www.aqa.in Tel +91 040 2322 2894/895, 2322 1228 Fax +91 040 2322 3023

QM015	Bureau of Indian Standards	Bureau of Indian Standards 9, Bahadur Shah Zafar Marg New Delhi - 110 002 (India)	www.bis.org.in Telefax: +91 11 2323 1842
QM016	URS Certification Ltd.	B-8, Dayanand Colony, Lajpat Nagar - IV New Delhi - 110 024	www.ursindia.com Tel + 91 11 2622 3444 Fax + 91 11 2622 6974
QM018	Transpacific Certifications Ltd.	59/10, Old Rajinder Nagar, New Delhi 110060	www.tlcertifications.com Tel / Fax +91 11 235 25107/ 08/12
QM019	Knowledge Partner QR Pvt. Ltd.	Address B-1, Nutech Narayana 48, Tirumalai Road, T. Nagar Chennai 600017 India	www.kpqr.com Tel + 91 44 4202 4230 Fax + 91 44 2834 2041
QM020	QMS Certification Services Pvt. Ltd.	207, Durga Towers, RDC, Raj Nagar Ghaziabad (U.P.) 210002	www.qmscertification.com Tel +91 120 282 4369, 652 6369, 647 1796 Fax +91 120 282 4369
QM021	Lloyd's Register Quality Assurance Ltd. (India Branch)	Solitaire Corporate Park, Building No. 1, 5th Floor, 151 M. VasANJI Road Chakala, Andheri East, Mumbai 400 093	Tel + 91 22 2825 8601/ 02 Fax + 91 22 2825 8618
QM022	Vexil Business Process Services Pvt. Ltd.	208A/4 Savitri Nagar, New Delhi 110017, India	www.vexilbps.com Tel + 91 11 3245 3661 Fax + 91 11 2601 8001
QM023	NQA Certification Pvt. Ltd.	# 15/1, 9th Main, Hampi Nagar (RPC Layout), Near Govt. Central Library, Vijayanagar II Stage, Bangalore - 560 040. India	www.nqaindia.com Tel + 91 80 3272 2698, 2314 2208, 2314 2407 Fax + 91 80 4117 8952.
QM024	QSS, Quality Management Services	'Sai Shraddha', 'C' Wing, Station Road, Vikhroli (East), Mumbai 400083, India	Tel + 91 22 2574 9499/3501 Mobile 0 98210 56619 Fax + 91 22 2574 6200
QM025	QSI (India) Certifications Pvt. Ltd.	557, Sector - 1, Vidyadhar Nagar, Jaipur - 302 023 (India)	www.qsi-india.com Tel +91 0141 2236 895 Fax +91 0141 2236 133 Mobile +91 98290 17133
QM026	RINA India Pvt. Ltd.	B Wing 607/608, Everest Chambers, Marol Naka, Andheri-Kurla Road, Andheri (E), Mumbai-400 059, India	www.rina.org Tel +91 022 2851 5862/63 Fax +91 022 2852 5139
QM027	SGS India Pvt. Ltd.	SGS House, 9-1-127/2, 43, Sarojini Devi Road, Secunderabad - 500 003, India	www.sgs.com Mobile 0 98488 14239

QM028	Global Certification Services	"Sathya Manor", W- 27/3, 1st Street, Anna Nagar, Chennai 600 040, India	www.global-certification.com Tel 044 2621 3360 Fax 044 2622 4657
QM029	NQAQSR Certification Pvt. Ltd.	107/55, Madhuban Building, Nehru Place, New Delhi-110019	www.nqacertification.com Tel 011 - 4654 2669 - 76 Fax +91 11 4163 6292/2921 7475
QM030	BSC International Certifications Co.	Office No. 124, Dwarka Complex, SCO 102-103, Sector 16, Faridabad Pin 121002, Haryana, India	www.bsc-icc.com Telefax: +91 129 3290068 / 98108 82505 / 93134 82505
QM031	Swiso (India) Pvt. Ltd.	507 Pragati Tower, 26 Rajendra Place New Delhi 110008	www.swisoindia.com Tel +91 11 41539720 Fax +91 11 41539721
QM032	KBS Certification Services Pvt. Ltd.	343, Om Shubham Tower Neelam - Bata Road N.I.T. Faridabad - 121 001 (Haryana)	Tel +91 129 4034513, 4054513 Fax +91 0129 4034513 Mobile +91 98107 12926
QM033	Intertek Systems Certification (a division of Intertek Testing Services India Pvt. Ltd.)	501 Everest House, 4th Floor 6 Suren Road Andheri (East) Mumbai - 400093	Tel +91 22 6703 8686 Fax +91 22 6703 8688
QM034	STQC Certification Services	Ministry of Communication & IT STQC Directorate, Electronic Niketan 6, CGO Complex, Lodhi Road New Delhi 110003	Tel +91 11 2436 3107/2430 1817 Fax +91 11 2436 3083

### ANNEXURE-II

#### List of Certification Bodies for Environmental Management Systems for 14000 Series:

Accrn. No.	Name	Address	Website & Phone
EM001	Det Norske Veritas AS (Certification Services, India)	203, Savitri Sadan 1, 11, Preet Vihar Community Centre, New Delhi-110 092 India	www.dnv.com Tel +91 11 2202 3242 Fax +91 11 2202 3244
EM002	TUV India Pvt. Ltd.	801, Raheja Plaza-I, L.B.S Marg, Ghatkopar (West), Mumbai-400 086	www.tuvindia.co.in Tel + 91 22 6647 7000 Fax + 91 22 6647 7009
EM003	International Certification Services Pvt. Ltd.	22/23, Goodwill Premises, Swastik Estate, 178, CST Road, Kalina, Santacruz (East) Mumbai-400 098 (Maharashtra)	www.icsasian.com Tel + 91 22 2650 7777-82 Fax + 91 22 2650 7777-82 extension-333

EM004	Bureau Veritas Certification (India) Pvt. Ltd.	Marwah Centre, 6th Floor, Opposite Ansa Industrial Estate, Kishanlal Marwah Marg, Off Sakivihar Road, Andheri East, Mumbai - 400 072	www.certification.bureauveritas.co.in Tel +91 22 6695 6330 Fax +91 22 6695 6302
EM005	Indian Register Quality Systems (IRQS) Dept. of Indian Register of Shipping	161 A, Maker Towers 'E' (16th Floor), Cuffe Parade, Mumbai - 400 005	www.irclass.org Tel +91 22 2215 3871/ 2215 4162 / 2215 4164 Fax +91 22 2215 4250
EM006	NVT Quality Certification Pvt. Ltd.	CAP-1, EOIZ, Export Promotion Industrial Park, Near ITPL, Whitefield, Bangalore-560 066, India	www.nvtqualitygroup.org Tel +91-80-5534 3536/ 37 Fax +91-80-2841 6767
EM007	Lloyd's Register Quality Assurance Ltd. (India Branch)	Solitaire Corporate Park, Building No. 1, 5th Floor, 151 M. Vasanji Road Chakala, Andheri East, Mumbai 400 093	Tel + 91 22 2825 8601/ 02 Fax + 91 22 2825 8618
EM008	Vexil Business Process Services Pvt. Ltd.	208A/4 Savitri Nagar, New Delhi 110017, India	www.vexilbps.com Tel + 91 11 3245 3661 Fax + 91 11 2601 8001
EM009	TUV South Asia Private Limited	321, Solitaire Corporate Park, Chakala, Andheri (East) Mumbai - 400 093	www.tuv-sud.in www.tuvsouthasia.com Tel +91 22 6692 3415 Fax +91 22 6692 3418
EM010	AQSR India Private Limited	3rd Floor, 7 Community Center East of Kailash New Delhi-110 065 (India)	www.aqsr.com Tel +91 11 4160 1242, 3294 2268 Fax +91 11 4160 1243
EM011	NQAQSR Certification Pvt. Ltd.	107/55, Madhuban Building, Nehru Place, New Delhi-110019	www.nqacertification.com Tel 011 - 4654 2669-76 Fax +91 11 4163 6292/2921 7475

## EXERCISES

### Section A

1. Define quality.
2. What do you mean by inspection?
3. Mention the objectives of inspection.
4. Mention any four drawbacks of inspection.
5. What do you mean by 'control'?
6. Mention the control process.
7. Define 'quality control'.



8. Mention different types of quality control.
9. What is statistical process control?
10. What is QC?
11. Mention two types of control charts.
12. Mention the characteristics of control charts.
13. What is P-chart?
14. What do you mean by 'quality circles'?
15. What do you mean by TQM?
16. Mention the five international standards of ISO 9000 series.
17. What is ISO?

### Section B

1. What is inspection? Explain the purpose of inspection.
2. Explain the different methods of inspection.
3. Explain the steps in quality control process.
4. Explain the objectives of quality control.
5. Explain the cause of variation in quality.
6. What are the benefits of using control charts.
7. Explain the objectives of control charts.
8. Explain the benefits of TQM.
9. What are the benefits of ISO 9000 series?
10. What are the steps in ISO 9000 registration?

### Section C

1. Discuss the different types of inspection.
2. Discuss the seven tools for quality control.
3. Discuss the fundamental factors affecting quality.
4. Discuss the '9 M' 's of quality of product or service.

### Skill Development

**FAST FOOD RESTAURANT VISIT:** Get the information for the following questions:

1. Quality control technique adopted for raw material.
2. Maintenance of quality in the process of manufacture.
3. Method of quality control technique (i.e. inspection or sampling technique).
4. Quality control tools used (i.e. Pareto chart, Scatter diagram etc.)
5. Application of control charts (i.e. control charts for variable i.e. thickness and size of pizza, and for attributes i.e. number of defects in process of manufacturing)
6. Types of errors in accepting or rejecting samples (i.e. accepting bad one and rejecting good one or vice versa).

7. Total quality Management approach for continual improvement of quality.
8. Quality standard certification obtained if any.

### CASELET

***The Roots of Quality Control in Japan: An Interview with W. Edwards Deming Dr. Deming, you said it will take about thirty years for the United States to catch up with Japan. This is a somewhat pessimistic view of the United States. Would you elaborate on this point?***

I don't really know how long it will take. I think it will take thirty years; it should take all of thirty years. I don't think America will catch up with Japan because, so far as I can see, the Japanese system has the advantage over the American system. For example, consider the principle of constancy of purpose, which is absolutely vital and is number one in my Fourteen Points. It refers to planning for the future with constancy of purpose.

Now in America some companies certainly do have constancy of purpose, but most do not. Most have a president who was brought in to improve the quarterly dividend. That's his job; you can't blame him for doing it. He'll be there a while, and then go on to some other place to raise the quarterly dividend there. For instance, someone told me that there were five candidates for president of one of the biggest and most famous of America's companies. When one of them was selected, the other four resigned from the company. Such a thing could not happen in Japan. So you see, the American system is so set up that it cannot use the talents of its people. That's very serious.

People cannot work for the company. They only get out their quota. You can't blame a person for doing the job that is cut out for him since he has to pay his rent and take care of his family. You can't blame him, but you can blame management for a situation in which people cannot work for the company. An employee cannot remain on the job to find out for sure what the job is. The foreman does not have time to help him. As a matter of fact, the foreman may decide a particular person cannot do the job at all and perhaps should be let go. People report equipment out of order and nothing happens. If someone reports equipment out of order more than three or four times, that person is considered a troublemaker. If he tries to find out more about the job from the foreman, he is considered a troublemaker. People find out that it is impossible to do what is best for the company or do their best work for the company. They just have to carry on as best they can, given the handicaps.

In addition, people have to use materials that are not suited to the job, and this creates a sense of desperation. There isn't much they can do about it-if they report, or try to do something, they are labeled troublemakers. This situation does not exist in Japan. There, everyone is willing to help everyone else.

***Dr. Deming, as you've mentioned, one of the Fourteen Points emphasizes constancy of purpose. Personally, I learned a great deal from that. Could you elaborate a little more on that point?***

A good way to assess a company's constancy of purpose is to evaluate the source of ultimate authority in that company. To whom does the president of the company answer? Does anybody own the company? Do the owners answer to the stockholders? The stockholders, thousands of them, who want dividends-to whom do they answer? Do they answer to their

consciences? Do they answer to a built-in institution? Do they answer to a constitution of the company? Is there a constitution for the company?

Some companies have a constitution. In medical service, for example, you have some constancy of purpose. Not all, but some nursing homes or other medical institutions are under the governance of a religious board, and they're very exact about service. The head of the organization answers to constancy of purpose. There is a constitution with an aim of going beyond the making of dividends.

You have to pay to keep such institutions going, but their job is service. The reason why the public school systems fail in America is because the schools don't answer to anybody. There is no constitution. What is their aim? Is it to teach, or to produce? Is it to help youngsters that have ability to develop that ability, or is it something else? I don't know. The aim is not stated, so the schools are failing.

***We hear that American companies are now changing and adopting such things as quality control. Do you think American companies are heeding your message?***

Many companies are forming QC circles in America without understanding what they're doing. QC circles cannot be effective in the absence of quality control, which means management actively adopting my Fourteen Points. Many companies are forming QC circles because management wants a lazy way to avoid the job of improving quality and productivity. These circles will make a worthwhile contribution if they are given a chance, but QC circles alone are not quality control. Once it becomes obvious that management is working on the Fourteen Points and is trying to do something to make people more effective in their work, then the workers will be creative.

Can you imagine people in a QC circle being effective when half of them will be turned out on the streets when business slacks off? Can you imagine an effective QC circle when half or even fewer of the people involved were rehired after being laid off during a slump? People have to feel secure. That means, according to the word's derivation, "without concern," from the Latin *se* for "without" and *cure* meaning "care" or "concern." Security means being able to speak, ask each other questions, and, help one another. There is nothing to hide and no one to please. Most people who work are only trying to please somebody because otherwise they might not have a job.

The lack of constancy of purpose in America is very serious. For example, I received a letter from a man who asked what he could do that would have a lasting benefit for his company. The problem is, the man will probably be where he is for only two more years. At the end of two years, he will either be promoted or he will look for a job with another company. He asked what fire he could start that would continue to burn after he leaves his job, whether he is promoted at the same company or goes elsewhere. It's a very serious question. I don't know if there is an answer.

There is another serious matter in this country: the supposition that quality control consists of a bag of techniques. Quality control is more than just a set of techniques. But you cannot have quality control without physical techniques. One of my Fourteen Points is to remove fear within a company, to make people secure. I don't know of any physical techniques to bring this about. But it is through physical techniques that I discovered the existence of fear. Fear is costing

companies a great deal of money and causing a lot of waste in out-of-order machines and rework. Fear causes wasted human effort and wasted materials. It arises because people do not understand their jobs, and have no place to go for help. I don't know of any statistical technique by which to establish constancy of purpose and eliminate fear.

Statistical techniques are certainly necessary for purchasing and selling materials, since without them you cannot measure or understand the quality of what you are buying. American industry and American government, especially the military, are being rooked by the practice of purchasing from the lowest bidder. They are forcing everyone to conform to the lowest price. That is wrong because there is no such thing as price without a measure of quality. Purchasing departments are not prepared to measure quality; they only know arithmetic. They understand that thirteen cents less per thousand pieces translates into so many thousands of dollars per year. But they don't understand that the quality of these pieces may be so bad that it will cause a great deal of trouble.

*You already referred to American management's lack of understanding of quality control for production processes. Could we go back to that?*

Most American managers 'have no idea how deep the trouble is, and those who do have no idea of what can be done. There is no way for them to learn what to do that I know of.

*In the United States, I have been intrigued by the notion of the trade-off between quality and price and the trade-off between productivity and quality. Here these are seen as different things, and yet your message, which you say the Japanese have accepted, is not to treat quality and price, and productivity and quality, as trade-off. Why has this been so difficult for Americans to understand?*

Americans simply have no idea of what quality is. Ask almost any plant manager in this country and he'll say it is a trade-off, that you have one or the other. He does not know that you can have both, and that once you have quality, then you can have productivity, lower costs, and a better market position. Here, people don't know this, but they know it in Japan. In 1950 in Japan, I was able to get top management together for conferences to explain what they had to do. No such gathering has ever been held in America and I don't know if anybody has any way of organizing one. In Japan, Mr. Ishikawa of JUSE organized conferences with top management in July 1950, again in August, then six months later, and so on. Top management understood from the beginning what they must do, and that as they improved quality, productivity would increase. They had some examples within six months, and more within a year. News of these examples spread throughout the country, and everyone learned about them because Japanese management was careful to disseminate the information.

The supposition of so many Americans that better quality means more gold plating or polishing, more time spent to do better work, is just not true. Quality improvement means improving the process so it produces quality without rework, quickly and directly. In other words, quality means making it right the first time so you don't have to rework it. By improving the process, you decrease wasted human effort, wasted machine time and materials, and you get a better product. If you decrease rework by six percent, you increase the productivity of a production line by six percent; and increase its capacity by the same amount. Therefore, in many cases, increased capacity could be achieved in this country simply by reducing wasted human

effort, machine time, and materials. In this country, better use of existing machinery-not new machinery or automation-is the answer.

***How do you respond to American management's idea that mechanization and automation are cost-saving devices rather than quality-improvement devices? In Japan mechanization and automation are seen as quality improvement, obviously with cost-saving benefits on the side. But in Japan they're working toward mechanization, automation, and the use of robots as quality-improvement devices.***

New machinery and automation very often bring higher costs, not lower ones. They also bring headaches and troubles, which a company is unprepared to handle. The result is that they decrease production, increase costs, lower quality, and create problems the company never had before. The best thing to do is learn to use what you have efficiently. Once you learn that, then there's a possibility you may learn to use more sophisticated equipment. I'm afraid that time is a long way off for this country.

In Japan, now that they're using present equipment successfully and efficiently and cannot extract any more capacity, the only way to increase production is with new automated machinery, because there are no more people to employ. There are no employment agencies in Japan where you can find people to work in plants. In the United States, on the other hand, there are seven million unemployed, maybe half of whom are actually able and willing to work, and are good workers.

***Back in the 1950s, you made a prophetic statement when you told the Japanese that if they pursued this quality-first approach, Japan would dominate the world market and everyone, including the United States, would demand protection from Japanese imports. Did you make that prediction because you were convinced that American industries were not pursuing the proper course of action in this field?***

No, I saw, through the conferences with the top management in Japan, that Japan could do a better job with quality control than America had ever done. Americans had not done well with quality control because they thought of it as a bag of techniques. As a group, management in America never knew anything about quality control. What you had in America, from the intensive statistical courses I started at Stanford University, were brilliant fires and applications all over the country. But when a person changed jobs, the fire burned out and there was nobody in management to keep it going.

We held the first course at Stanford in July 1942, and seventeen people came. Two months later, Stanford University gave another course, and later other universities gave courses. I taught twenty-three of them myself. By that time, they would be attended by fifty or sixty or seventy people. The War Department also gave courses at defense suppliers' factories. Quality control became a big fire. As a matter of fact, courses were given to a total of ten thousand people from eight hundred companies, but nothing happened.

Brilliant applications burned, sputtered, fizzled, and died out. What people did was solve individual problems; they did not create a structure at the management level to carry out their obligations. There was not sufficient appreciation at the management level to spread the methods to other parts of the company.

The man who saw these things first was Dr. Holbrook working at Stanford. He knew the job that management must carry out. He saw it first. We tried, but our efforts were feeble, and

the results were zero. We did not know how to do it. In our eight-day courses, we would ask companies to send their top people, but top people did not come. Some came for one afternoon. You don't learn this in one afternoon. So quality control died out in America.

Let me put it this way: more and more, quality control in America became merely statistical methods-the more applications, the better. Instead of finding many problems, we need to find the big problem. Where are the problems? Let's find the big problems first. What methods will help? Maybe no methods will help. Let's be careful-so many things that happen are just carelessness. We don't need control charts for them. We just need some action from management to cut that carelessness. Wrong design? That's management's fault. Recall of automobiles? Management's fault, not the workers' fault.

People started control charts everywhere. The Ford Company had charts all over their assembly plants across the country, one chart on top of another. Quality control "experts" sat and made more and more charts. One man told me his job was to count the number of points out of control every day. But what happened was nothing. Quality control drifted into so-called quality control departments that made charts. They would look at the charts and perhaps tell somebody if something was out of control. The only people who could do anything never saw the charts and never learned anything. That included everybody. Top management never heard or learned anything; people on the production lines did not learn anything. That was totally wrong, because the first step is for management to take on my Fourteen Points, namely, to gain purpose. The Japanese had already accomplished this task. The Japanese were all ready to work on training. JUSE was ready. But in 1950, quality control had practically died out in America. When I went to Japan in 1950, I said to myself, "Why repeat in Japan the mistakes that were made in America? I must get hold of top management and explain to them what their job is, because unless they do their part, these wonderful engineers will accomplish nothing. They will make business applications and then the fire will burn out."

It was at that time I was fortunate enough to meet Mr. Ichiro Ishikawa, who, after three conferences, sent telegrams to forty-five men in top management telling them to come and hear me. Well, I did a very poor job, but I explained what management must do, what quality control is from a management standpoint. For example, I told them to improve incoming materials, which means working with vendors as if they were members of your family, and teaching them. I told them they must learn statistical control of quality. It's a big job.

Incoming materials were wretched, deplorable, and nobody seemed to care. They just thought that industry consisted of taking what you got and doing the best you could. But I explained that that won't do because now you must compete. The consumer you never thought of-to whom you must now export-is in America, Canada, and Europe. Improve agriculture, yes, but the better way-the quicker way, the most effective way-is to export quality. They thought it could not be done. They said they had never done it, that they had a bad reputation. I told them, you can do it-you have to do it, you must. You must learn statistical methods. These methods of quality control must be a part of everybody's job.

At that time, consumer research was unknown in Japan, but the aim of making products was to help somebody. I think they had never thought of the consumer as the most important end of the production line. I told them they must study the needs of the consumer. They must look ahead

one year, three years, eight years, to be ahead in new services and new products. As they learned, they must teach everyone else. Well, that was the natural Japanese way. I did not know how much, but I gave them that advice.

***How did you develop your own views, not only of statistical control methods, but also your central message that quality determines productivity?***

By simple arithmetic, if you have material coming in that is difficult to use -and there was plenty of it coming to Japan in 1950-you will produce a lot of wasted human effort, machine time, and materials. There will be a lot of rework, with people occupying time trying to overcome the deficiencies of defective incoming material. So if you have better material coming in, you eliminate waste; production, quality, and productivity go up; costs go down; and your market position is improved.

Well I think that I have put some principles on paper that everybody knew but that, in a sense, nobody knew. They had never been put down on paper. I stated those principles in Japan in the summer of 1950, some for the first time. They're obvious, perhaps, as Newton's laws of motion are obvious. But like Newton's laws, they're not obvious to everyone.

***Is there a company in the United States that has heeded your message? Are there some isolated cases?***

The Nashua Corporation in Nashua, New Hampshire, under the direction of its former president, William E. Conway, was off to a good start. Mr. Conway himself was doing a great deal, not only for his corporation, but for American industry. Almost every day, visiting teams of ten to fifteen people from other companies came to Mr. Conway's offices and plants to hear about what he was doing. He was getting a very good start. The entire company was meant for quality.

***Why is he so different from other American managers?***

I don't know. There are other good companies. Some of them have started lately and they are pushing along one of the great problems is finding competent statistical consultants. There are very few that can give competent training. One company I work with must train fifty thousand people to discover problems how long do you think it will take the purchasing department to learn to take quality into consideration along with price? It will take five years or more, and at the end of five years a lot of people will be gone. They will have other jobs. It's going to take a long time. There is no quick road.

## Discussion Questions

- (a) Dr. Deming seems to put more emphasis on corporate culture than on quality control methodology. What is necessary to change a corporate culture to be as quality conscious as Deming feels is necessary to compete in global markets?
- (b) What are the relationships between quality and productivity?
- (c) If automation continues to be installed in both Japanese and U.S. industry, will the quality problem be solved by technology?
- (d) What are the prospects for making the quality of U.S. manufactured products companies? How can such a goal be achieved, given the current Japanese lead?

[Source: These edited interviews were given by Dr. Deming to the Pacific Basin Center Foundation on September 8, 1981, and July 28, 1984]

# 7

## WORK STUDY (TIME AND MOTION STUDY)

### CHAPTER OUTLINE

7.1 Introduction

7.2 Productivity

7.3 Work Study

7.4 Method Study

7.5 Motion Study

7.6 Work Measurement

7.7 Time Study

- Exercises

- Skill Development

- Caselet

### 7.1 INTRODUCTION

Productivity has now become an everyday watch word. It is crucial to the welfare of industrial firm as well as for the economic progress of the country. High productivity refers to doing the work in a shortest possible time with least expenditure on inputs without sacrificing quality and with minimum wastage of resources.

Work-study forms the basis for work system design. The purpose of work design is to identify the most effective means of achieving necessary functions. This work-study aims at improving the existing and proposed ways of doing work and establishing standard times for work performance. Work-study is encompassed by two techniques, *i.e.*, method study and work measurement.

*“Method study is the systematic recording and critical examination of existing and proposed ways of doing work, as a means of developing and applying easier and more effective methods and reducing costs.”*

*“Work measurement is the application or techniques designed to establish the time for a qualified worker to carry out a specified job at a defined level or performance.”*



There is a close link between method study and work measurement. Method study is concerned with the reduction of the work content and establishing the one best way of doing the job whereas work measurement is concerned with investigation and reduction of any ineffective time associated with the job and establishing time standards for an operation carried out as per the standard method.

## 7.2 PRODUCTIVITY

Productivity is the quantitative relation between what we produce and we use as a resource to produce them, *i.e.*, arithmetic ratio of amount produced (output) to the amount of resources (input). Productivity can be expressed as:

$$\text{Productivity} = \frac{\text{Output}}{\text{Input}}$$

Productivity refers to the efficiency of the production system. It is the concept that guides the management of production system. It is an indicator to how well the factors of production (land, capital, labour and energy) are utilised.

European Productivity Agency (EPA) has defined productivity as,

*“Productivity is an attitude of mind. It is the mentality of progress, of the constant improvements of that which exists. It is the certainty of being able to do better today than yesterday and continuously. It is the constant adaptation of economic and social life to changing conditions. It is the continual effort to apply new techniques and methods. It is the faith in progress.”*

A major problem with productivity is that it means many things to many people. Economists determine it from Gross National Product (GNP), managers view it as cost cutting and speed up, engineers think of it in terms of more output per hour. But generally accepted meaning is that it is the relationship between goods and services produced and the resources employed in their production.

### 7.2.1 Factors Influencing Productivity

Factors influencing productivity can be classified broadly into two categories: (A) controllable (or internal) factors and (B) un-controllable (or external) factors.

#### (A) CONTROLLABLE (OR INTERNAL) FACTORS

1. **Product factor:** In terms of productivity means the extent to which the product meets output requirements product is judged by its usefulness. The cost benefit factor of a product can be enhanced by increasing the benefit at the same cost or by reducing cost for the same benefit.

2. **Plant and equipment:** These play a prominent role in enhancing the productivity. The increased availability of the plant through proper maintenance and reduction of idle time increases the productivity. Productivity can be increased by paying proper attention to utilisation, age, modernisation, cost, investments etc.

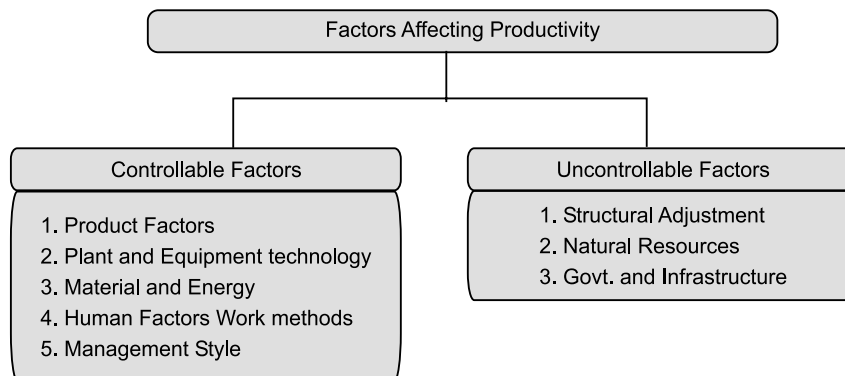

**Fig. 7.1** Factors influencing productivity

3. **Technology:** Innovative and latest technology improves productivity to a greater extent. Automation and information technology helps to achieve improvements in material handling, storage, communication system and quality control. The various aspects of technology factors to be considered are:

- (i) Size and capacity of the plant,
- (ii) Timely supply and quality of inputs,
- (iii) Production planning and control,
- (iv) Repairs and maintenance,
- (v) Waste reduction, and
- (vi) Efficient material handling system.

4. **Material and energy:** Efforts to reduce materials and energy consumption brings about considerable improvement in productivity.

- 1. Selection of quality material and right material.
- 2. Control of wastage and scrap.
- 3. Effective stock control.
- 4. Development of sources of supply.
- 5. Optimum energy utilisation and energy savings.

5. **Human factors:** Productivity is basically dependent upon human competence and skill. Ability to work effectively is governed by various factors such as education, training, experience aptitude etc., of the employees. Motivation of employees will influence productivity.

6. **Work methods:** Improving the ways in which the work is done (methods) improves productivity, work study and industrial engineering techniques and training are the areas which improve the work methods, which in term enhances the productivity.

7. **Management style:** This influence the organizational design, communication in organization, policy and procedures. A flexible and dynamic management style is a better approach to achieve higher productivity.

#### **(B) UN-CONTROLLABLE (OR EXTERNAL) FACTORS**

1. **Structural adjustments:** Structural adjustments include both economic and social changes. Economic changes that influence significantly are:

- (a) Shift in employment from agriculture to manufacturing industry,
- (b) Import of technology, and
- (c) Industrial competitiveness.

Social changes such as women's participation in the labour force, education, cultural values, attitudes are some of the factors that play a significant role in the improvement of productivity.

2. **Natural resources:** Manpower, land and raw materials are vital to the productivity improvement.

3. **Government and infrastructure:** Government policies and programmes are significant to productivity practices of government agencies, transport and communication power, fiscal policies (interest rates, taxes) influence productivity to the greater extent.

### 7.2.2 Total Productivity Measure (TPM)

It is based on all the inputs. The model can be applied to any manufacturing organization or service company.

$$\text{Total productivity} = \frac{\text{Total tangible output}}{\text{Total tangible input}}$$

$$\text{Total tangible output} = \text{Value of finished goods produced} + \text{Value of partial units produced} + \text{Dividends from securities} + \text{Interest} + \text{Other income}$$

$$\text{Total tangible input} = \text{Value of (human + material + capital + energy + other inputs) used. The word tangible here refers to measurable.}$$

The output of the firm as well as the inputs must be expressed in a common measurement unit. The best way is to express them in rupee value.

### 7.2.3 Partial Productivity Measures (PPM)

Depending upon the individual input partial productivity measures are expressed as:

$$\text{Partial productivity} = \frac{\text{Total output}}{\text{Individual input}}$$

$$1. \quad \text{Labour productivity} = \frac{\text{Total output}}{\text{Labour input}}$$

Labour input is measured in terms of man-hours

$$2. \quad \text{Capital productivity} = \frac{\text{Total output}}{\text{Capital input}}$$

$$3. \quad \text{Material productivity} = \frac{\text{Total output}}{\text{Material input}}$$

$$4. \quad \text{Energy productivity} = \frac{\text{Total output}}{\text{Energy input}}$$

One of the major disadvantage of partial productivity measures is that there is an over emphasis on one input factor to the extent that other input are underestimated or even ignored.

### 7.2.4 Productivity Improvement Techniques

#### (A) TECHNOLOGY BASED

1. **Computer Aided Design (CAD), Computer Aided Manufacturing (CAM), and Computer Integrated Manufacturing Systems (CIMS):** CAD refers to design of products, processes or systems with the help of computers. The impact of CAD on human productivity is significant for the advantages of CAD are:

- (a) Speed of evaluation of alternative designs,
- (b) Minimisation of risk of functioning, and
- (c) Error reduction.

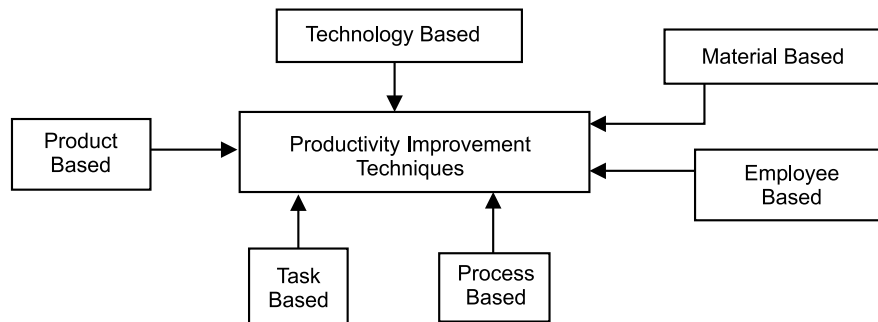

CAM is very much useful to design and control the manufacturing. It helps to achieve the effectiveness in production system by line balancing.

- (a) Production Planning and Control
- (b) Capacity Requirements Planning (CRP), Manufacturing Resources Planning (MRP II) and Materials Requirement Planning (MRP)
- (c) Automated Inspection.

2. **Computer integrated manufacturing:** Computer integrated manufacturing is characterised by automatic line balancing, machine loading (scheduling and sequencing), automatic inventory control and inspection.

1. Robotics
2. Laser technology
3. Modern maintenance techniques
4. Energy technology
5. Flexible Manufacturing System (FMS)

#### (B) EMPLOYEE BASED

1. Financial and non-financial incentives at individual and group level.
2. Employee promotion.
3. Job design, job enlargement, job enrichment and job rotation.

4. Worker participation in decision-making
5. Quality Circles (QC), Small Group Activities (SGA)
6. Personal development.

**(C) MATERIAL BASED**

1. Material planning and control
2. Purchasing, logistics
3. Material storage and retrieval
4. Source selection and procurement of quality material
5. Waste elimination.

**(D) PROCESS BASED**

1. Methods engineering and work simplification
2. Job design evaluation, job safety
3. Human factors engineering.

**(E) PRODUCT BASED**

1. Value analysis and value engineering
2. Product diversification
3. Standardisation and simplification
4. Reliability engineering
5. Product mix and promotion.

**(F) TASK BASED**

1. Management style
2. Communication in the organisation
3. Work culture
4. Motivation
5. Promotion group activity.

**ILLUSTRATION 1:** A company produces 160 kg of plastic moulded parts of acceptable quality by consuming 200 kg of raw materials for a particular period. For the next period, the output is doubled (320 kg) by consuming 420 kg of raw material and for a third period, the output is increased to 400 kg by consuming 400 kg of raw material.

**SOLUTION:** During the first year, production is 160 kg

$$\text{Productivity} = \frac{\text{Output}}{\text{Input}} = \frac{160}{200} = 0.8 \text{ or } 80\%$$

For the second year, production is increased by 100%

$$\text{Productivity} = \frac{\text{Output}}{\text{Input}} = \frac{320}{420} = 0.76 \text{ or } 76\% \downarrow$$

For the third period, production is increased by 150%

$$\text{Productivity} = \frac{\text{Output}}{\text{Input}} = \frac{400}{400} = 1.0, \text{ i.e., } 100\% \uparrow$$

From the above illustration it is clear that, for second period, though production has doubled, productivity has decreased from 80% to 76% for period third, production is increased by 150% and correspondingly productivity increased from 80% to 100%.

**ILLUSTRATION 2 :** *The following information regarding the output produced and inputs consumed for a particular time period for a particular company is given below:*

<i>Output</i>	–	<i>Rs. 10,000</i>
<i>Human input</i>	–	<i>Rs. 3,000</i>
<i>Material input</i>	–	<i>Rs. 2,000</i>
<i>Capital input</i>	–	<i>Rs. 3,000</i>
<i>Energy input</i>	–	<i>Rs. 1,000</i>
<i>Other misc. input</i>	–	<i>Rs. 500</i>

*The values are in terms of base year rupee value. Compute various productivity indices.*

**SOLUTION:**

Partial productivity

$$1. \text{ Labour productivity} = \frac{\text{Output}}{\text{Human input}} = \frac{10,000}{3,000} = 3.33$$

$$2. \text{ Capital productivity} = \frac{\text{Output}}{\text{Capital input}} = \frac{10,000}{3,000} = 3.33$$

$$3. \text{ Material productivity} = \frac{\text{Output}}{\text{Material input}} = \frac{10,000}{2,000} = 5.00$$

$$4. \text{ Energy productivity} = \frac{\text{Output}}{\text{Energy input}} = \frac{10,000}{1,000} = 10.00$$

$$5. \text{ Other misc. expenses} = \frac{\text{Output}}{\text{Other misc. input}} = \frac{10,000}{500} = 20.00$$

$$6. \text{ Total productivity} = \frac{\text{Total output}}{\text{Total input}}$$

$$= \frac{\text{Total output}}{(\text{Human} + \text{Material} + \text{Capital} + \text{Energy} + \text{Other misc. input})}$$

$$= \frac{10,000}{3,000 + 2,000 + 3,000 + 1,000 + 500}$$

$$= \frac{10,000}{9,500} = \mathbf{1.053}$$

$$\begin{aligned}
 7. \text{ Total factor productivity (TFP)} &= \frac{\text{Net output}}{(\text{Labour} + \text{Capital}) \text{ Input}} \\
 &= \frac{\text{Total output} - \text{Material and services purchased}}{(\text{Labour} + \text{Capital}) \text{ Input}}
 \end{aligned}$$

Assume that the company purchases all its material and services including energy, misc. and equipment (leasing). Then,

$$\begin{aligned}
 \text{Total factor productivity} &= \frac{10,000 - (2,000 + 3,000 + 1,000 + 500)}{3,000 + 3,000} \\
 &= \frac{3,500}{6,000} = \mathbf{0.583}
 \end{aligned}$$

### 7.3 WORK STUDY

“**Work study** is a generic term for those techniques, method study and work measurement which are used in the examination of human work in all its contexts. And which lead systematically to the investigation of all the factors which affect the efficiency and economy of the situation being reviewed, in order to effect improvement.”

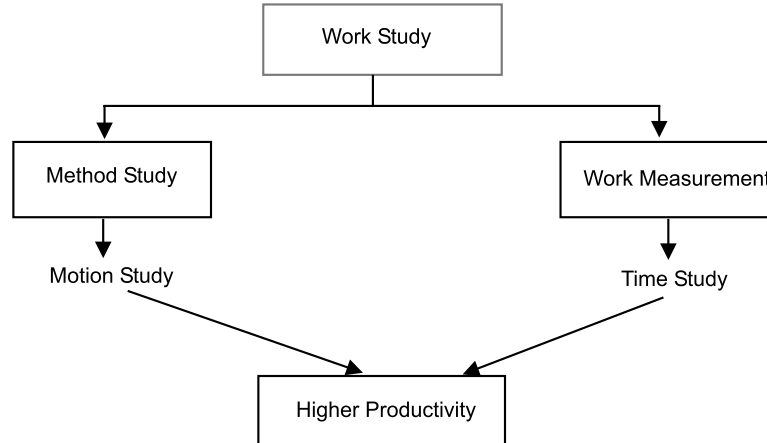

**Fig. 7.2** Framework of work study

Work study is a means of enhancing the production efficiency (productivity) of the firm by elimination of waste and unnecessary operations. It is a technique to identify non-value adding operations by investigation of all the factors affecting the job. It is the only accurate and systematic procedure oriented technique to establish time standards. It is going to contribute to the profit as the savings will start immediately and continue throughout the life of the product.

Method study and work measurement is part of work study. Part of method study is motion study, work measurement is also called by the name ‘Time study’.

### 7.3.1 Advantages of Work Study

Following are the advantages of work study:

1. It helps to achieve the smooth production flow with minimum interruptions.
2. It helps to reduce the cost of the product by eliminating waste and unnecessary operations.
3. Better worker-management relations.
4. Meets the delivery commitment.
5. Reduction in rejections and scrap and higher utilisation of resources of the organization.
6. Helps to achieve better working conditions.
7. Better workplace layout.
8. Improves upon the existing process or methods and helps in standardisation and simplification.
9. Helps to establish the standard time for an operation or job which has got application in manpower planning, production planning.

## 7.4

### METHOD STUDY

**Method study** enables the industrial engineer to subject each operation to systematic analysis. The main purpose of method study is to eliminate the unnecessary operations and to achieve the best method of performing the operation.

Method study is also called **methods engineering or work design**. Method engineering is used to describe collection of analysis techniques which focus on improving the effectiveness of men and machines.

According to British Standards Institution (BS 3138): “*Method study is the systematic recording and critical examination of existing and proposed ways of doing work as a means of developing and applying easier and more effective methods and reducing cost.*”

Fundamentally method study involves the breakdown of an operation or procedure into its component elements and their systematic analysis. In carrying out the method study, the right attitude of mind is important. The method study man should have:

1. The desire and determination to produce results.
2. Ability to achieve results.
3. An understanding of the human factors involved.

Method study scope lies in improving work methods through process and operation analysis, such as:

1. Manufacturing operations and their sequence.
2. Workmen.
3. Materials, tools and gauges.
4. Layout of physical facilities and work station design.
5. Movement of men and material handling.
6. Work environment.



### 7.4.1 Objectives of Method Study

Method study is essentially concerned with finding better ways of doing things. It adds value and increases the efficiency by eliminating unnecessary operations, avoidable delays and other forms of waste.

The improvement in efficiency is achieved through:

1. Improved layout and design of workplace.
2. Improved and efficient work procedures.
3. Effective utilisation of men, machines and materials.
4. Improved design or specification of the final product.

The objectives of method study techniques are:

1. Present and analyse true facts concerning the situation.
2. To examine those facts critically.
3. To develop the best answer possible under given circumstances based on critical examination of facts.

### 7.4.2 Scope of Method Study

The scope of method study is not restricted to only manufacturing industries. Method study techniques can be applied effectively in service sector as well. It can be applied in offices, hospitals, banks and other service organizations.

The areas to which method study can be applied successfully in manufacturing are:

1. To improve work methods and procedures.
2. To determine the best sequence of doing work.
3. To smoothen material flow with minimum of back tracking and to improve layout.
4. To improve the working conditions and hence to improve labour efficiency.
5. To reduce monotony in the work.
6. To improve plant utilisation and material utilisation.
7. Elimination of waste and unproductive operations.
8. To reduce the manufacturing costs through reducing cycle time of operations.

### 7.4.3 Steps or Procedure Involved in Methods Study

The basic approach to method study consists of the following eight steps. The detailed procedure for conducting the method study is shown in Fig. 7.3.

1. **SELECT** the work to be studied and define its boundaries.
2. **RECORD** the relevant facts about the job by direct observation and collect such additional data as may be needed from appropriate sources.
3. **EXAMINE** the way the job is being performed and challenge its purpose, place sequence and method of performance.

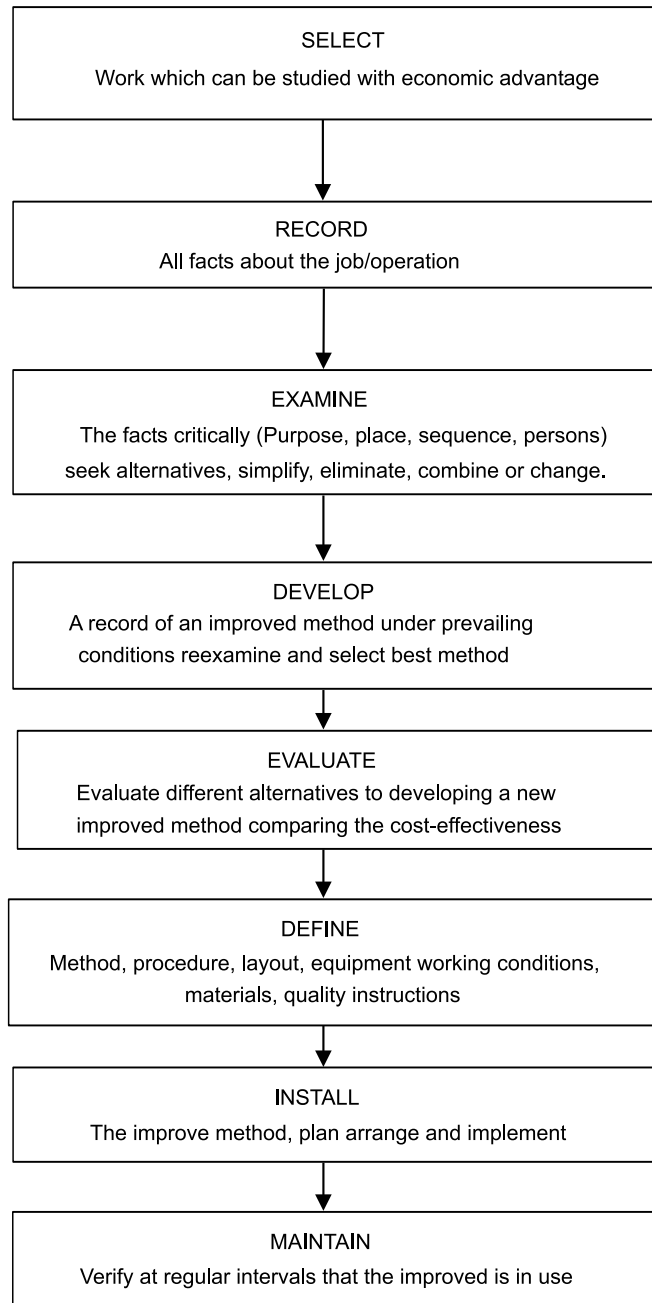

**Fig. 7.3.** *Method study procedure*

4. **DEVELOP** the most practical, economic and effective method, drawing on the contributions of those concerned.

5. **EVALUATE** different alternatives to developing a new improved method comparing the cost-effectiveness of the selected new method with the current method with the current method of performance.
6. **DEFINE** the new method, as a result, in a clear manner and present it to those concerned, *i.e.*, management, supervisors and workers.
7. **INSTALL** the new method as a standard practice and train the persons involved in applying it.
8. **MAINTAIN** the new method and introduce control procedures to prevent a drifting back to the previous method of work.

**Note:** Only the first two steps have been dealt in detail.

#### 7.4.4 Selection of the Job for Method Study

Cost is the main criteria for selection of a job, process and department for methods analysis. To carry out the method study, a job is selected such that the proposed method achieves one or more of the following results:

- (a) Improvement in quality with lesser scrap.
- (b) Increased production through better utilisation of resources.
- (c) Elimination of unnecessary operations and movements.
- (d) Improved layout leading to smooth flow of material and a balanced production line.
- (e) Improved working conditions.

#### CONSIDERATIONS FOR SELECTION OF METHOD STUDY

The job should be selected for the method study based upon the following considerations:

1. Economic aspect
2. Technical aspect, and
3. Human aspect.

#### A. Economic Aspects

The method study involves cost and time. If sufficient returns are not attained, the whole exercise will go waste. Thus, the money spent should be justified by the savings from it. The following guidelines can be used for selecting a job:

- (a) Bottleneck operations which are holding up other production operations.
- (b) Operations involving excessive labour.
- (c) Operations producing lot of scrap or defectives.
- (d) Operations having poor utilisation of resources.
- (e) Backtracking of materials and excessive movement of materials.

#### B. Technical Aspects

The method study man should be careful enough to select a job in which he has the technical knowledge and expertise. A person selecting a job in his area of expertise is going to do full justice.

Other factors which favour selection in technical aspect are:

1. Job having in consistent quality.
2. Operations generating lot of scraps.
3. Frequent complaints from workers regarding the job.

### C. Human Considerations

Method study means a change as it is going to affect the way in which the job is done presently and is not fully accepted by workman and the union. Human considerations play a vital role in method study. These are some of the situations where human aspect should be given due importance:

1. Workers complaining about unnecessary and tiring work.
2. More frequency of accidents.
3. Inconsistent earning.

#### 7.4.5 Recording Techniques for Method Study

The next step in basic procedure, after selecting the work to be studied is to record all facts relating to the existing method. In order that the activities selected for investigation may be visualised in their entirety and in order to improve them through subsequent critical examination, it is essential to have some means of placing on record all the necessary facts about the existing method. Records are very much useful to make before and after comparison to assess the effectiveness of the proposed improved method.

The recording techniques are designed to simplify and standardise the recording work. For this purpose charts and diagrams are used.

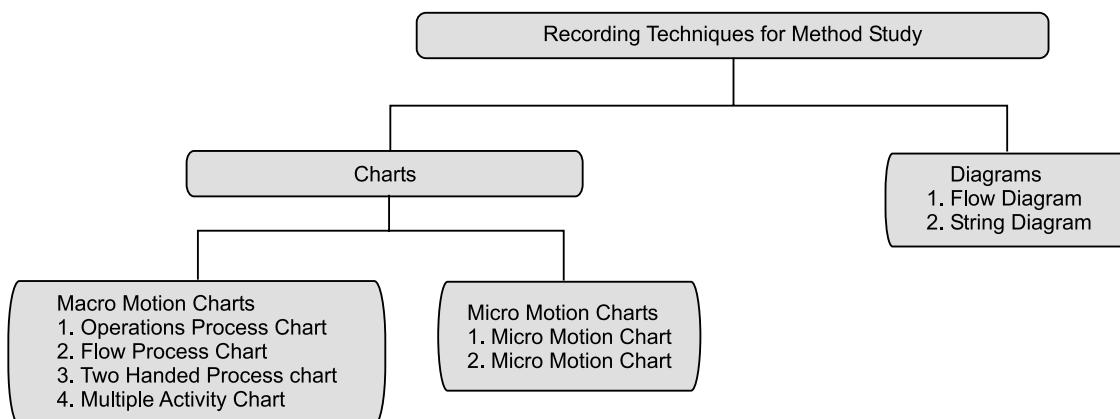

**Fig. 7.4** Recording techniques for method study

### CHARTS USED IN METHODS STUDY

This is the most popular method of recording the facts. The activities comprising the jobs are recorded using method study symbols. A great care is to be taken in preparing the charts so that

the information it shows is easily understood and recognized. The following information should be given in the chart. These charts are used to measure the movement of operator or work (*i.e.*, in motion study).

- (a) Adequate description of the activities.
- (b) Whether the charting is for present or proposed method.
- (c) Specific reference to when the activities will begin and end.
- (d) Time and distance scales used wherever necessary.
- (e) The date of charting and the name of the person who does charting.

### Types of Charts

It can be broadly divided into (A) Macro motion charts and (B) Micro motion charts.

Macro motion charts are used for macro motion study and micro motion charts are used for micro motion study.

Macro motion study is one which can be measured through 'stop watch' and micro motion study is one which cannot be measured through stop watch.

#### (A) MACRO MOTION CHARTS

Following four charts are used under this type:

##### 1. Operation Process Chart

It is also called outline process chart. An operation process chart gives the bird's eye view of the whole process by recording only the major activities and inspections involved in the process. Operation process chart uses only two symbols, *i.e.*, operation and inspection. Operation, process chart is helpful to:

- (a) Visualise the complete sequence of the operations and inspections in the process.
- (b) Know where the operation selected for detailed study fits into the entire process.
- (c) In operation process chart, the graphic representation of the points at which materials are introduced into the process and what operations and inspections are carried on them are shown.

##### 2. Flow Process Chart

Flow process chart gives the sequence of flow of work of a product or any part of it through the work centre or the department recording the events using appropriate symbols. It is the amplification of the operation process chart in which operations; inspection, storage, delay and transportation are represented. However, process charts are of three types:

- (a) Material type—Which shows the events that occur to the materials.
- (b) Man type—Activities performed by the man.
- (c) Equipment type—How equipment is used.

The flow process chart is useful:

- (a) to reduce the distance travelled by men (or materials).
- (b) to avoid waiting time and unnecessary delays.

- (c) to reduce the cycle time by combining or eliminating operations.
- (d) to fix up the sequence of operations.
- (e) to relocate the inspection stages.

Like operation process chart, flow process chart is constructed by placing symbols one below another as per the occurrence of the activities and are joined by a vertical line. A brief description of the activity is written on the right hand side of the activity symbol and time or distance is given on the left hand side.

### 3. Two Handed Process Chart

A two handed (operator process chart) is the most detailed type of flow chart in which the activities of the workers hands are recorded in relation to one another. The two handed process chart is normally confined to work carried out at a single workplace. This also gives synchronised and graphical representation of the sequence of manual activities of the worker. The application of this charts are:

- To visualise the complete sequence of activities in a repetitive task.
- To study the work station layout.

### 4. Multiple Activity Chart

It is a chart where activities of more than subject (worker or equipment) are each recorded on a common time scale to show their inter-relationship. Multiple activity chart is made:

- to study idle time of the man and machines,
- to determine number of machines handled by one operator, and
- to determine number of operators required in teamwork to perform the given job.

### Diagrams Used in Method Study

The flow process chart shows the sequence and nature of movement but it does not clearly show the path of movements. In the paths of movements, there are often undesirable features such as congestion, back tracking and unnecessary long movements. To record these unnecessary features, representation of the working area in the form of flow diagrams, string diagrams can be made:

1. To study the different layout plans and thereby; select the most optimal layout.
2. To study traffic and frequency over different routes of the plant.
3. Identification of back tracking and obstacles during movements. Diagrams are of two types: 1. Flow diagram and 2. String diagram.

#### 1. FLOW DIAGRAM

Flow diagram is a drawing, of the working area, showing the location of the various activities identified by their numbered symbols and are associated with particular flow process chart either man type or machine type.

The routes followed in transport are shown by joining the symbols in sequence by a line which represents as nearly as possible the path or movement of the subject concerned.

Following are the procedures to make the flow diagram:

1. The layout of the workplace is drawn to scale.
2. Relative positions of the machine tools, work benches, storage, and inspection benches are marked on the scale.
3. Path followed by the subject under study is tracked by drawing lines.
4. Each movement is serially numbered and indicated by arrow for direction.
5. Different colours are used to denote different types of movements.

## 2. STRING DIAGRAM

The string diagram is a scale layout drawing on which, length of a string is used to record the extent as well as the pattern of movement of a worker working within a limited area during a certain period of time. The primary function of a string diagram is to produce a record of an existing set of conditions so that the job of seeing what is actually taking place is made as simple as possible.

One of the most valuable features of the string diagram is the actual distance travelled during the period of study to be calculated by relating the length of the thread used to the scale of drawing. Thus, it helps to make a very effective comparison between different layouts or methods of doing job in terms of the travelling involved.

The main advantages of string diagram compared to flow diagram is that respective movements between work stations which are difficult to be traced on the flow diagram can be conveniently shown on string diagram.

Following are the procedures to draw string diagram:

1. A layout of the work place of factory is drawn to scale on the soft board.
2. Pins are fixed into boards to mark the locations of work stations, pins are also driven at the turning points of the routes.
3. A measured length of the thread is taken to trace the movements (path).
4. The distance covered by the object is obtained by measuring the remaining part of the thread and subtracting it from original length.

## Symbols Used in Method Study

Graphical method of recording was originated by Gilberth, in order to make the presentation of the facts clearly without any ambiguity and to enable to grasp them quickly and clearly. It is useful to use symbols instead of written description.

### (A) METHOD STUDY SYMBOLS

- OPERATION
- INSPECTION
- TRANSPORTATION
- D DELAY
- ▽ STORAGE

**Operation O**

An operation occurs when an object is intentionally changed in one or more of its characteristics (physical or chemical). This indicates the main steps in a process, method or procedure.

An operation always takes the object one stage ahead towards completion.

Examples of operation are:

- Turning, drilling, milling, etc.
- A chemical reaction.
- Welding, brazing and riveting.
- Lifting, loading, unloading.
- Getting instructions from supervisor.
- Taking dictation.

**Inspection □**

An inspection occurs when an object is examined and compared with standard for quality and quantity. The inspection examples are:

- Visual observations for finish.
- Count of quantity of incoming material.
- Checking the dimensions.

**Transportation →**

A transport indicates the movement of workers, materials or equipment from one place to another.

*Example:* Movement of materials from one work station to another.

Workers travelling to bring tools.

**Delay D: Delay (Temporary Storage)**

A delay occurs when the immediate performance of the next planned thing does not take place.

*Example:* Work waiting between consecutive operations.

Workers waiting at tool cribs.

Operators waiting for instructions from supervisor.

**Storage ▽**

Storage occurs when the object is kept in an authorised custody and is protected against unauthorised removal. For example, materials kept in stores to be distributed to various work.

**ILLUSTRATION 1.** *Develop a Process Chart for making a cheese sandwich.*

**SOLUTION.** The following chart is one possible solution. The level of detail in process charts depends upon the requirements of the job. Time is often included to aid analysis of value added.



**Process Chart**

<i>Distance in metre</i>	<i>Symbol</i>	<i>Process description</i>
10	⇒	Move to cabinet
-	○	Get loaf of bread
-	○	Remove two slices of bread
-	○	Lay slices on counter-top
-	○	Close loaf of bread
-	○	Replace loaf of bread on shelf
-	○	Open butter
-	○	Spread butter on top slice of bread
-	□	Inspect sandwich
10	⇒	Move to serving area
-	○	Serve sandwich

**ILLUSTRATION 2.** Develop a Multiple Activity Chart for doing three loads of laundry, assume you will have access to one washing machine and one dryer.

**SOLUTION:** The following chart is one possible solution. The level of detail in process charts depends upon the requirements of the job. Time is often included to aid analysis of value added.

**Multiple Activity Chart**

<i>Time</i>	<i>Operator</i>	<i>Machine 1 Washer</i>	<i>Machine 2 Dryer</i>
Repeat Cycle	Load clothes and detergent in to Machine 1	Being loaded	Idle
	Idle	Run	Idle
	Remove clothes from Machine 1	Being unloaded	Idle
	Load clothes into Machine 2	Idle	Being loaded
	Load clothes and detergent into Machine 1	Being loaded	Run
	Idle	Run	Run
	Remove clothes from Machine 2	Idle	Being unloaded
	Hang clothes	Idle	Idle

**(B) MICRO-MOTION STUDY CHART**

Micro-motion study provides a technique for recording and timing an activity. It is a set of techniques intended to divide the human activities in a groups of movements or micro-motions

(called Therbligs) and the study of such movements helps to find for an operator one best pattern of movements that consumes less time and requires less effort to accomplish the task. Therbligs were suggested by Frank O. Gilbreth, the founder of motion study. Micro-motion study was mainly employed for the job analysis. Its other applications includes:

1. As an aid in studying the activities of two or more persons on a group work?
2. As an aid in studying the relationship of the activities of the operator and the machine as a means of timing operations.
3. As an aid in obtaining motion time data for time standards.
4. Acts as permanent record of the method and time of activities of the operator and the machine.

**TABLE 7.1 SIMO chart symbols**

<i>Sl. No.</i>	<i>Code</i>	<i>Name</i>	<i>Description</i>	<i>Colour</i>
1.	SH	SEARCH	Locate and article	Black
2.	F	FIND	Mental reaction at end of search	Gray
3.	ST	SELECT	Selection from a member	Light Gray
4.	G	GRASP	Taking Hold	Red
5.	H	HOLD	Prolonged group	Gold Ochre
6.	TL	TRANSPORTED LOADED	Moving an article	Green
7.	P	POSITION	Placing in a definite location	Blue
8.	A	ASSEMBLE	Putting parts together	Violet
9.	U	USE	Causing a device to perform its function	Purple
10.	DA	DISASSEMBLE	Separating parts	Light Violet
11.	I	INSPECT	Examine or test	Burnt Ochre
12.	PP	PREPOSITION	Placing an article ready for use	Pale Blue
13.	RL	RELEASE LOAD	Release an article	Carmin red
14.	TE	TRANSPORT EMPTY	Movement of a body member	Olive Green
15.	R	REST	Pause to overcome fatigue	Orange
16.	JD	UNAVOIDABLE DELAY	Idle-outside persons control	Yellow
17.	PN	PLAN	Mental plan for future action	—

The micro-motion group of techniques is based on the idea of dividing human activities into division of movements or groups of movements (Therbligs) according to purpose for which they are made. Gilbreth differentiated 17 fundamental hand or hand and eye motions. Each Therbligs

has a specific colour, symbol and letter for recording purposes. The Therbligs are micro-motion study involves the following steps:

1. Filming the operation to be studied.
2. Analysis of the data from the film.

The recording of the data through **SIMO chart** is done as micro motion chart.

### **SIMO Chart**

Simultaneous motion cycle chart (SIMO chart) is a recording technique for micro-motion study. A SIMO chart is a chart based on the film analysis, used to record simultaneously on a common time scale the Therbligs or a group of Therbligs performed by different parts of the body of one or more operators.

It is the micro-motion form of the man type flow process chart. To prepare SIMO chart, an elaborate procedure and use of expensive equipment are required and this study is justified when the saving resulting from study will be very high.

## **7.5 MOTION STUDY**

Motion study is part of method study where analysis of the motion of an operator or work will be studied by following the prescribed methods.

### **7.5.1 Principles of Motion study**

There are a number of principles concerning the economy of movements which have been developed as a result of experience and which forms the basis for the development of improved methods at the workplace. These are first used by Frank Gilbreth, the founder of motion study and further rearranged and amplified by Barnes, Maynard and others.

The principles are grouped into three headings:

- (a) Use of the human body.
- (b) Arrangement of workplace.
- (c) Design of tools and equipment.

#### **(A) USES OF HUMAN BODY**

*When possible:*

1. The two hands should begin and complete their movements at the same time.
2. The two hands should not be idle at the same time except during periods of rest.
3. Motions of the arms should be made simultaneously.
4. Hand and body motions should be made at the lowest classification at which it is possible to do the work satisfactorily.
5. Momentum should be employed to help the worker, but should be reduced to a minimum whenever it has to be overcome by muscular effort.
6. Continuous curved movements are to be preferred to straight line motions involving sudden and changes in directions.
7. 'Ballistic' (*i.e.*, free swinging) movements are faster, easier and more accurate than restricted or controlled movements.

8. Rhythm is essential to the smooth and automatic performance of a repetitive operation. The work should be arranged to permit easy and natural rhythm wherever possible.
9. Work should be arranged so that eye movements are confined to a comfortable area, without the need for frequent changes of focus.

**(B) ARRANGEMENT OF THE WORKPLACE**

1. Definite and fixed stations should be provided for all tools and materials to permit habit formation.
2. Tools and materials should be pre-positioned to reduce searching.
3. Gravity fed, bins and containers should be used to deliver the materials as close to the point of use as possible.
4. Tools, materials and controls should be located within a maximum working area and as near to the worker as possible.
5. Materials and tools should be arranged to permit the best sequence of motions.
6. 'Drop deliveries' or ejectors should be used wherever possible, so that the operative does not have to use his hands to dispose of finished parts.
7. Provision should be made for adequate lightning, and a chair of type and height to permit good posture should be provided. The height of the workplace and seat should be arranged to allow alternate standing and seating.

**(C) DESIGN OF TOOLS AND EQUIPMENTS**

1. The colour of the workplace should contrast with that of work and thus reduce eye fatigue.
2. The hands should be relieved of all work of 'holding' the work piece where this can be done by a jig or fixture or foot operated device.
3. Two or more tools should be combined where possible.
4. Where each finger performs some specific movement, as in typewriting, the load should be distributed in accordance with the inherent capacities of the fingers.
5. Handles such as those used on screw drivers and cranks should be designed to permit maximum surface of the hand to come in contact with the handle.
6. Levers, cross bars and wheel bars should be in such position that operator can manipulate them with least body change and with greatest mechanical advantage.

### 7.5.2 Recording Techniques of Motion Study

Most of the techniques mentioned in method study is used in the motion study. They are as follows:

#### 1. Macro Motion Study

- (a) Flow process chart
- (b) Two handed process chart.

## 2. Micro Motion Study

SIMO chart.

[Note: Explained earlier in this chapter.]

## 7.6 WORK MEASUREMENT

Work measurement is also called by the name 'time study'. Work measurement is absolutely essential for both the planning and control of operations. Without measurement data, we cannot determine the capacity of facilities or it is not possible to quote delivery dates or costs. We are not in a position to determine the rate of production and also labour utilisation and efficiency. It may not be possible to introduce incentive schemes and standard costs for budget control.

### 7.6.1 Objectives of Work Measurement

The use of work measurement as a basis for incentives is only a small part of its total application. The objectives of work measurement are to provide a sound basis for:

1. Comparing alternative methods.
2. Assessing the correct initial manning (manpower requirement planning).
3. Planning and control.
4. Realistic costing.
5. Financial incentive schemes.
6. Delivery date of goods.
7. Cost reduction and cost control.
8. Identifying substandard workers.
9. Training new employees.

### 7.6.2 Techniques of Work Measurement

For the purpose of work measurement, work can be regarded as:

1. **Repetitive work:** The type of work in which the main operation or group of operations repeat continuously during the time spent at the job. These apply to work cycles of extremely short duration.

2. **Non-repetitive work:** It includes some type of maintenance and construction work, where the work cycle itself is hardly ever repeated identically.

Various techniques of work measurement are:

1. Time study (stop watch technique),
2. Synthesis,
3. Work sampling,
4. Predetermined motion and time study,
5. Analytical estimating.

Time study and work sampling involve direct observation and the remaining are data based and analytical in nature.

1. **Time study:** A work measurement technique for recording the times and rates of working for the elements of a specified job carried out under specified conditions and for analysing the data so as to determine the time necessary for carrying out the job at the defined level of performance. In other words measuring the time through stop watch is called time study.

2. **Synthetic data:** A work measurement technique for building up the time for a job or parts of the job at a defined level of performance by totalling element times obtained previously from time studies on other jobs containing the elements concerned or from synthetic data.

3. **Work sampling:** A technique in which a large number of observations are made over a period of time of one or group of machines, processes or workers. Each observation records what is happening at that instant and the percentage of observations recorded for a particular activity, or delay, is a measure of the percentage of time during which that activities delay occurs.

4. **Predetermined motion time study (PMTS):** A work measurement technique whereby times established for basic human motions (classified according to the nature of the motion and conditions under which it is made) are used to build up the time for a job at the defined level of performance. The most commonly used PMTS is known as **Methods Time Measurement (MTM)**.

5. **Analytical estimating:** A work measurement technique, being a development of estimating, whereby the time required to carry out elements of a job at a defined level of performance is estimated partly from knowledge and practical experience of the elements concerned and partly from synthetic data.

The work measurement techniques and their applications are shown in Table 7.2.

**TABLE 7.2: Work measurement techniques and their application**

<i>Techniques</i>	<i>Applications</i>	<i>Unit of measurement</i>
1. Time study	Short cycle repetitive jobs. Widely used for direct work.	Centiminute (0.01 min)
2. Synthetic Data	Short cycle repetitive jobs.	Centi minutes
3. Working sampling	Long cycle jobs/heterogeneous operations.	Minutes
4. MTM	Manual operations confined to one work centre.	TMU (1 TMU = 0.006 min)
5. Analytical estimation	Short cycle non-repetitive job.	Minutes

## 7.7 TIME STUDY

Time study is also called work measurement. It is essential for both planning and control of operations.

According to British Standard Institute time study has been defined as “*The application of techniques designed to establish the time for a qualified worker to carry out a specified job at a defined level of performance.*”

### 7.7.1 Steps in Making Time Study

Stop watch time is the basic technique for determining accurate time standards. They are economical for repetitive type of work. Steps in taking the time study are:

1. Select the work to be studied.
2. Obtain and record all the information available about the job, the operator and the working conditions likely to affect the time study work.
3. Breakdown the operation into elements. An element is a distinct part of a specified activity composed of one or more fundamental motions selected for convenience of observation and timing.
4. Measure the time by means of a stop watch taken by the operator to perform each element of the operation. Either continuous method or snap back method of timing could be used.
5. At the same time, assess the operators effective speed of work relative to the observer's concept of 'normal' speed. This is called performance rating.
6. Adjust the observed time by rating factor to obtain normal time for each element

$$\text{Normal} = \frac{\text{Observed time} \times \text{Rating}}{100}$$

7. Add the suitable allowances to compensate for fatigue, personal needs, contingencies, etc. to give standard time for each element.
8. Compute allowed time for the entire job by adding elemental standard times considering frequency of occurrence of each element.
9. Make a detailed job description describing the method for which the standard time is established.
10. Test and review standards wherever necessary. The basic steps in time study are represented by a block diagram in Fig. 7.5.

### 7.7.2 Computation of Standard Time

Standard time is the time allowed to an operator to carry out the specified task under specified conditions and defined level of performance. The various allowances are added to the normal time as applicable to get the standard time as shown in Fig. 7.6.

Standard time may be defined as the, amount of time required to complete a unit of work: (a) under existing working conditions, (b) using the specified method and machinery, (c) by an operator, able to the work in a proper manner, and (d) at a standard pace.

Thus basic constituents of standard time are:

1. Elemental (observed time).
2. Performance rating to compensate for difference in pace of working.
3. Relaxation allowance.
4. Interference and contingency allowance.
5. Policy allowance.

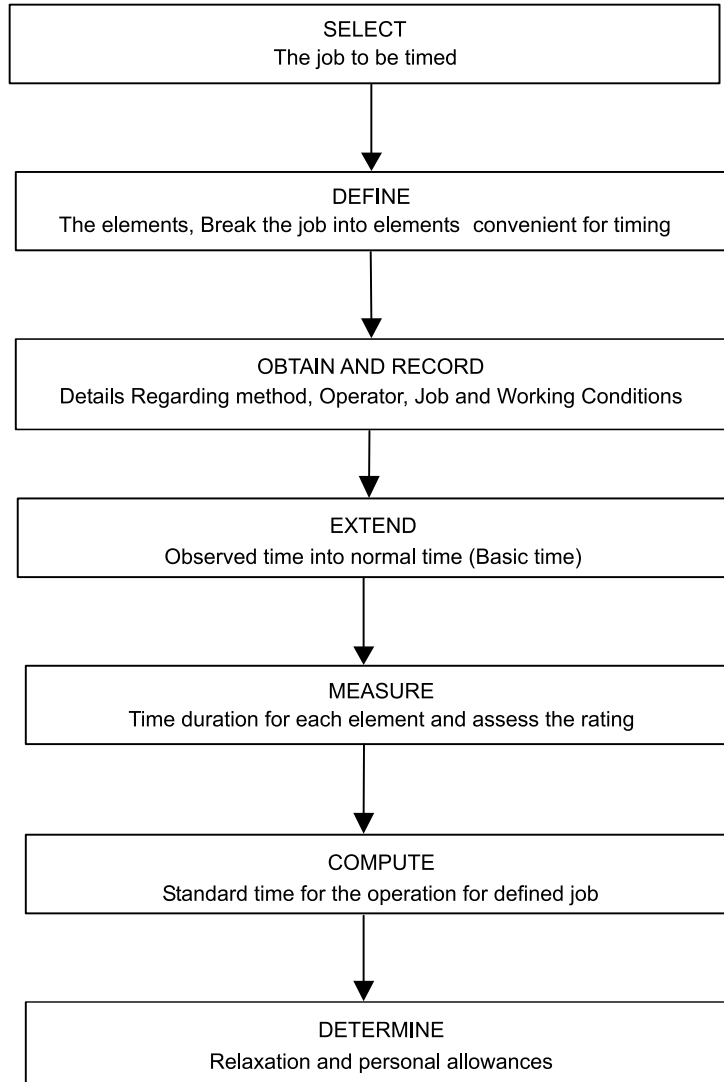

**Fig. 7.5** Steps in time study

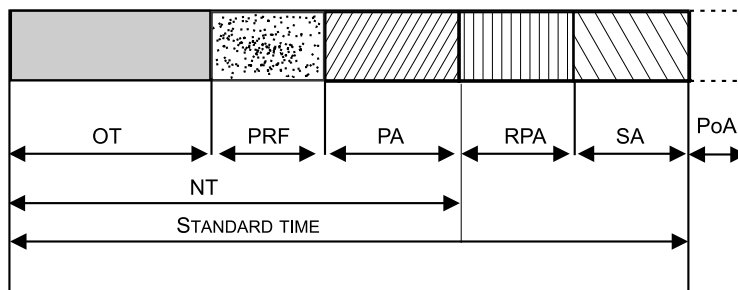

**Fig. 7.6** Components standard time



OT	–	Observed Time
PRF	–	Performance Rating Factor
NT	–	Normal Time
PA	–	Process Allowances
RPA	–	Rest and Personal Allowances
SA	–	Special Allowances
PoA	–	Policy Allowances

## Allowances

The normal time for an operation does not contain any allowances for the worker. It is impossible to work throughout the day even though the most practicable, effective method has been developed. Even under the best working method situation, the job will still demand the expenditure of human effort and some allowance must therefore be made for recovery from fatigue and for relaxation. Allowances must also be made to enable the worker to attend to his personal needs. The allowances are categorised as: (1) Relaxation allowance, (2) Interference allowance, and (3) Contingency allowance.

### 1. RELAXATION ALLOWANCE

Relaxation allowances are calculated so as to allow the worker to recover from fatigue. Relaxation allowance is a addition to the basic time intended to provide the worker with the opportunity to recover from the physiological and psychological effects of carrying out specified work under specified conditions and to allow attention to personal needs. The amount of allowance will depend on nature of the job.

Relaxation allowances are of two types: fixed allowances and variable allowances.

**Fixed allowances** constitute:

- (a) **Personal needs allowance:** It is intended to compensate the operator for the time necessary to leave, the workplace to attend to personal needs like drinking water, smoking, washing hands. Women require longer personal allowance than men. A fair personal allowance is 5% for men, and 7% for women.
- (b) **Allowances for basic fatigue:** This allowance is given to compensate for energy expended during working. A common figure considered as allowance is 4% of the basic time.

### 2. VARIABLE ALLOWANCE

Variable allowance is allowed to an operator who is working under poor environmental conditions that cannot be improved, added stress and strain in performing the job.

The variable fatigue allowance is added to the fixed allowance to an operator who is engaged on medium and heavy work and working under abnormal conditions. The amount of variable fatigue allowance varies from organization to organization.

### 3. INTERFERENCE ALLOWANCE

It is an allowance of time included into the work content of the job to compensate the operator for the unavoidable loss of production due to simultaneous stoppage of two or more machines being operated by him. This allowance is applicable for machine or process controlled jobs.

Interference allowance varies in proportion to number of machines assigned to the operator. The interference of the machine increases the work content.

#### 4. CONTINGENCY ALLOWANCE

A contingency allowance is a small allowance of time which may be included in a standard time to meet legitimate and expected items of work or delays. The precise measurement of which is uneconomical because of their infrequent or irregular occurrence.

This allowance provides for small unavoidable delays as well as for occasional minor extra work:

Some of the examples calling for contingency allowance are:

- Tool breakage involving removal of tool from the holder and all other activities to insert new tool into the tool holder.
- Power failures of small duration.
- Obtaining the necessary tools and gauges from central tool store. Contingency allowance should not exceed 5%.

#### 5. POLICY ALLOWANCE

Policy allowances are not the genuine part of the time study and should be used with utmost care and only in clearly defined circumstances.

The usual reason for making the policy allowance is to line up standard times with requirements of wage agreement between employers and trade unions.

The policy allowance is an increment, other than bonus increment, applied to a standard time (or to some constituent part of it, *e.g.*, work content) to provide a satisfactory level of earnings for a specified level of performance under exceptional circumstances. Policy allowances are sometimes made as imperfect functioning of a division or part of a plant.

**ILLUSTRATION 1:** *Assuming that the total observed time for an operation of assembling an electric switch is 1.00 min. If the rating is 120%, find normal time. If an allowance of 10% is allowed for the operation, determine the standard time.*

**SOLUTION:**

Observed time (or) selected time = 1.00 min  
 Rating = 120%  
 Allowance = 10%

As we know that, normal time = Observed time  $\times \frac{\text{Rating \%}}{100}$   
 $= 1.00 \times \frac{120}{100} = \mathbf{1.20 \text{ min}}$

Allowance @ 10% =  $1.20 \times \frac{10}{100} = \mathbf{0.12 \text{ min}}$

$\therefore$  Standard time = Normal time + Allowances  
 $= 1.20 + 0.12 = \mathbf{1.32 \text{ min.}}$

**ILLUSTRATION 2:** An operator manufactures 50 jobs in 6 hours and 30 minutes. If this time includes the time for setting his machine. Calculate the operator's efficiency. Standard time allowed for the job was:

$$\text{Setting time} = 35 \text{ min}$$

$$\text{Production time per piece} = 8 \text{ min}$$

**SOLUTION:**

As standard time = Set up time + Time per piece  $\times$  No. of pieces produced

$\therefore$  Standard time for manufacturing 50 jobs

$$= 35 + 8 \times 50$$

$$= 435 \text{ min}$$

$$= 7 \text{ hours and } 15 \text{ min.}$$

$$\text{Efficiency of operator} = \frac{\text{Standard time} \times 100}{\text{Actual time}}$$

$$= \frac{435 \times 100}{390} = \mathbf{111.5\%}$$

**ILLUSTRATION 3:** Following datas were obtained by a work study. Man from a study conducted by hours.

(i) **Maintenance time**

(a) Get out and put away tools = 12.0 min/day

(b) Cleaning of machine = 5.0 min/day

(c) Oiling of machine = 5.0 min/day

(d) Replenish coolant supply = 3.0 min/day

(ii) **Interruption**

(a) Interruption by foreman = 5.0 min/day

(b) Interruption by porter etc. = 4.0 min/day

(iii) Delay time due to power failure etc. = 6.0 min/day

(iv) Personal time = 20.0 min/day

Calculate total allowances, total available cycle time productive hours, considering a working day of 8 hours.

**SOLUTION:**

Total allowance (sometimes also known as station time)

$$= \text{Total maintenance time} + \text{Interruption time}$$

$$+ \text{Delay time} + \text{Personal time}$$

$$= (12.0 + 5 + 5 + 3.0) + (5.0 + 4.0) + 6.0 + 20.0$$

$$= 25.0 + 9.0 + 6.0 + 20.0$$

$$= 60.0 \text{ min per day}$$

$\therefore$  Total available cycle time = Total work period – Total allowances

$$= 480 - 60 = \mathbf{420 \text{ min/day}}$$

$$\text{Productive hours} = \frac{\text{Time available}}{\text{Number of hours}}$$

$$= \frac{420}{8} = \mathbf{52.5 \text{ min.}}$$

**ILLUSTRATION 4:** Find out the standard time using the following data:

Average time for machine elements	= 6 min
Average time for manual elements	= 4 min
Performance rating	= 110%
Allowances	= 10%

**SOLUTION:**

$$\begin{aligned}\text{Normal time} &= \text{Machinery time} + \text{Manual time} \times \text{Rating} \\ &= 6 + 4 \times 1.1 \\ &= 6 + 4.4 = \mathbf{10.4 \text{ min}}\end{aligned}$$

∴ Standard time = Normal time + Allowances

$$\begin{aligned}&= 10.4 + 10.4 \times \frac{10}{100} \\ &= 10.4 (1 + 0.1) = \mathbf{11.44 \text{ min.}}\end{aligned}$$

## EXERCISES

### Section A

1. What do you mean by productivity?
2. What is work study?
3. What do you mean by work measurement?
4. How do you ascertain productivity?
5. What do you mean by total productivity measure?
6. What do you mean by partial productivity measure?
7. What is micro-motion study?
8. What is motion study?
9. What is time study?

### Section B

1. How do you achieve efficiency?
2. Explain the scope of method study.

### Section C

1. Discuss the factors influencing productivity.
2. Discuss the productivity improvement techniques.
3. Discuss the steps involved in method study.
4. Discuss different types of charts and diagrams used in methods study.
5. Discuss the principles of motion study.
6. Discuss the recording technique of motion study.
7. Discuss the various techniques of work measurement.
8. Discuss the steps in making time study.
9. Discuss the different types of allowances.

## Skill development

**FAST FOOD RESTAURANT VISIT:** Get the information for the following questions:

1. Steps involved in the preparation of pizza (method study).
2. Cycle time involved for placing of order till serving (Standard Time Calculation).
3. Process chart used for pizza preparation.

### CASELET

#### 1. TOYS AND JOB DESIGN AT THE HOVEY AND BEARD COMPANY

The following is a situation that occurred in the Hovey and Beard Company, as reported by J. V. Clark.

This company manufactured a line of wooden toys. One part of the process involved spray painting partially assembled toys, after which the toys were hung on moving hooks that carried them through a drying oven. The operation, staffed entirely by women, was plagued with absenteeism, high turnover, and low morale. Each woman at her paint booth would take a toy from the tray beside her, position it in a fixture, and spray on the color according to the required pattern. She then would release the toy and hang it on the conveyor hook. The rate at which the hooks moved had been calculated so that each woman, once fully trained, would be able to hang a painted toy on each hook before it passed beyond her reach.

The women who worked in the paint room were on a group incentive plan that tied their earnings to the production of the entire group. Since the operation was new, they received a learning allowance that decreased by regular amounts each month. The learning allowance was scheduled to fall to zero in six months because it was expected that the women could meet standard output or more by that time. By the second month of the training period, trouble had developed. The women had progressed more slowly than had been anticipated, and it appeared that their production level would stabilize somewhat below the planned level. Some of the women complained about the speed that was expected of them, and a few of them quit. There was evidence of resistance to the new situation.

Through the counsel of a consultant, the supervisor finally decided to bring the women together for general discussions of working conditions. After two meetings in which relations between the work group and the supervisor were somewhat improved, a third meeting produced the suggestion that control of the conveyor speed be turned over to the work group. The women explained that they felt that they could keep up with the speed of the conveyor but that they could not work at that pace all day long. They wished to be able to adjust the speed of the belt, depending on how they felt.

After consultation, the supervisor had a control marked, "low, medium, and fast" installed at the booth of the group leader, who could adjust the speed of the conveyor anywhere between the lower and upper limits that had been set. The women were delighted and spent many lunch

hours deciding how the speed should be varied from hour to hour throughout the day. Within a week, a pattern had emerged: the first half-hour of the shift was run on what the women called “medium speed” (a dial setting slightly above the point marked “medium”). The next two and one-half hours were run at high speed, and the half-hour before lunch and the half-hour after lunch were run at low speed. The rest of the afternoon was run at high speed, with the exception of the last 45 minutes of the shift, which were run at medium speed.

In view of the women’s report of satisfaction and ease in their work, it is interesting to note that the original speed was slightly below medium on the dial of the new control. The average speed at which the women were running the belt was on the high side of the dial. Few, if any, empty hooks entered the drying oven, and inspection showed no increase of rejects from the paint room. Production increased, and within three weeks the women were operating at 30 to 50 percent above the level that had been expected according to the original design.

Evaluate the experience of the Hovey and Beard Company as it reflects on job design, human relationships, and the supervisor’s role. How would you react as the supervisor to the situation where workers determine how the work will be performed? If you were designing the spray-painting set-up, would you design it differently?

[From J. V. Clark, “A Healthy Organization,” *California Management Review*, 4, 1962]

## 2. PRODUCTIVITY GAINS AT WHIRLPOOL

Workers and management at Whirlpool Appliance’s Benton Harbor plant in Michigan have set an example of how to achieve productivity gains, which has benefited not only the company and its stockholders, but also Whirlpool customers, and the workers themselves.

Things weren’t always rosy at the plant. Productivity and quality weren’t good. Neither were labor-management relations. Workers hid defective parts so management wouldn’t find them, and when machines broke down, workers would simply sit down until sooner or later someone came to fix it. All that changed in the late 1980s. Faced with the possibility that the plant would be shut down, management and labor worked together to find a way to keep the plant open. The way was to increase productivity-producing more without using more resources. Interestingly, the improvement in productivity didn’t come by spending money on fancy machines. Rather, it was accomplished by placing more emphasis on quality. That was a shift from the old way, which emphasized volume, often at the expense of quality. To motivate workers, the company agreed to gain sharing, a plan that rewarded workers by increasing their pay for productivity increases.

The company overhauled the manufacturing process, and taught its workers how to improve quality. As quality improved, productivity went up because more of the output was good, and costs went down because of fewer defective parts that had to be scrapped or reworked. Costs of inventory also decreased, because fewer spare parts were needed to replace defective output, both at the factory and for warranty repairs. And workers have been able to see the connection between their efforts to improve quality and productivity.

Not only was Whirlpool able to use the productivity gains to increase workers’ pay, it was also able to hold that lid on price increases and to funnel some of the savings into research.

### Questions

1. What were the two key things that Whirlpool management did to achieve productivity gains?
2. Who has benefited from the productivity gains?
3. How are productivity and quality related?
4. How can a company afford to pay its workers for productivity gains?

(Source: Based on "A Whirlpool Factory Raises Productivity-And Pay of Workers:" by Rick Wartzman, from The Wall Street Journal, 1992.)

### 3. STATE AUTOMOBILE LICENSE RENEWALS

Vinay, manager of a metropolitan branch office of the state department of motor vehicles, attempted to perform an analysis of the driver's license renewal operations. Several steps were to be performed in the process. After examining the license renewal process, he identified the steps and associated times required to perform each step as shown in table below.

State Automobile License Renewals Process Times		
	Job	Average Time to Perform (Seconds)
1	Review renewal application for correctness	15
2	Process and record payments	30
3	Check file for violations and restrictions	60
4	Conduct Eye Test	40
5	Photograph applicant	20
6	Issue temporary license	30

Vinay found that each step was assigned to a different person. Each application was a separate process in the sequence shown in the exhibit. Vinay determined that his office should be prepared to accommodate the maximum demand of processing 120 renewal applicants per hour.

He observed that the work was unevenly divided among the clerks, and that the clerk who was responsible for checking violations tended to shortcut her task to keep up with the other clerks. Long lines built up during the maximum demand periods.

Vinay also found that general clerks who were each paid Rs.12.00 per hour-handled jobs 1,2,3, and 4. Job 5 was performed by a photographer paid Rs.16 per hour, Job 6, the issuing of temporary licenses, was required by state policy to be handled by a uniformed motor vehicle officer. Officers were paid Rs.18 per hour, but they could be assigned to any job except photography.

A review of the jobs indicated that job 1, reviewing the application for correctness, had to be performed before any other step. Similarly, job 6, issuing the temporary license, could not be performed until all the other steps were completed. The branch offices were charged Rs.20 per hour for each camera to perform photography.

Vinay was under severe pressure to increase productivity and reduce costs, but the regional director of the department of motor vehicles also told him that he had better accommodate the demand for renewals. Otherwise, “heads would roll.”

### Questions

1. What is the maximum number of applications per hour that can be handled by the present configuration of the process?
2. How many applications can be processed per hour if a second clerk is added to check for violations?
3. Assuming the addition of one more clerk, what is the maximum number of applications the process can handle?
4. How would you suggest modifying the process to accommodate 120 applications per hour?

(Source: P. R. Olsen, W. E. Sasser, and D. D. Wyckoff, *Management of Service Operations: Text, Cases, and Readings*, Pp. 95-96, © 1978.)

### 4. MAKING HOTPLATES

Group of 10 workers were responsible for assembling hotplates (instruments for heating solutions to a given temperature) for hospital and medical laboratory use. A number of different models of hotplates were being manufactured. Some had a vibrating device so that the solution could be mixed while being heated. Others heated only test tubes. Still others could heat solutions in a variety of different containers.

With the appropriate small tools, each worker assembled part of a hotplate. The partially completed hotplate was placed on a moving belt, to be carried from one assembly station to the next. When the hotplate was completed, an inspector would check it over to ensure that it was working properly. Then the last worker would place it in a specially prepared cardboard box for shipping.

The assembly line had been carefully balanced by industrial engineers, who had used a time and motion study to break the job down into subassembly tasks, each requiring about three minutes to accomplish. The amount of time calculated for each subassembly had also been “balanced” so that the task performed by each worker was supposed to take almost exactly the same amount of time. The workers were paid a straight hourly rate.

However, there were some problems. Morale seemed to be low, and the inspector was finding a relatively high percentage of badly assembled hotplates. Controllable rejects—those “caused” by the operator rather than by faulty materials—were running about 23 percent.

After discussing the situation, management decided to try something new. The workers were called together and asked if they would like to build the hotplates individually. The workers decided they would like to try this approach, provided they could go back to the old program if the new one did not work well. After several days of training, each worker began to assemble the entire hotplate.

The change was made at about the middle of the year. Productivity climbed quickly. By the end of the year, it had leveled off at about 84 percent higher than during the first half of the year, although no other changes had been made in the department or its personnel. Controllable rejects



had dropped from 23 percent to 1 percent during the same period. Absenteeism had dropped from 8 percent to less than 1 percent. The workers had responded positively to the change, and their morale was higher. As one person put it, "Now, it is my hotplate." Eventually, the reject rate dropped so low that the assembly workers themselves did all routine final inspection. The fulltime inspector was transferred to another job in the organization.

### Questions

1. What changes in the work situation might account for the increase in productivity and the decrease in controllable rejects?
2. What might account for the drop in absenteeism and the increase in morale?
3. What were the major changes in the situation? Which changes were under the control of the manager? Which were controlled by workers?
4. What might happen if the workers went back to the old assembly line method?

(Source: The Modern Manager, by Edgar F. Huse, copyright @ 1979 by West Publishing Company.)

# 8

## MAINTENANCE MANAGEMENT

### CHAPTER OUTLINE

- |                                      |   |
|--------------------------------------|---|
| 8.1 <i>Introduction and Meaning</i>  | 8.6 <i>Maintenance Schedule Techniques</i>    |
| 8.2 <i>Objectives of Maintenance</i> | 8.7 <i>Total Productive Maintenance (TPM)</i> |
| 8.3 <i>Types of Maintenance</i>      | • <i>Exercises</i>                            |
| 8.4 <i>Maintenance Planning</i>      | • <i>Skill Development</i>                    |
| 8.5 <i>Maintenance Scheduling</i>    |   |

### 8.1 INTRODUCTION AND MEANING

Past and current maintenance practices in both the private and Government sectors would imply that maintenance is the actions associated with equipment repair after it is broken. The dictionary defines maintenance as “the work of keeping something in proper condition, upkeep.” This would imply that maintenance should be actions taken to prevent a device or component from failing or to repair normal equipment degradation experienced with the operation of the device to keep it in proper working order. Data obtained in many studies over the past decade indicates that most private and Government facilities do not expend the necessary resources to maintain equipment in proper working order. They wait for equipment failure to occur and then take whatever actions are necessary to repair or replace the equipment. Nothing lasts forever and all equipment has associated with it some predefined life expectancy or operational life.

### 8.2 OBJECTIVES OF MAINTENANCE

Equipments are an important resource which is constantly used for adding value to products. So, it must be kept at the best operating condition. Otherwise, there will be excessive downtime and also interruption of production if it is used in a mass production line. Poor working of equipments

will lead to quality related problems. Hence, it is an absolute necessity to maintain the equipments in good operating conditions with economical cost. Hence, we need an integrated approach to minimize the cost of maintenance. In certain cases, the equipment will be obsolete over a period of time. If a firm wants to be in the same business competitively, it has to take decision on whether to replace the equipment or to retain the old equipment by taking the cost of maintenance and operation into account.

### 8.3 TYPES OF MAINTENANCE

The design life of most equipment requires periodic maintenance. Belts need adjustment, alignment needs to be maintained, proper lubrication on rotating equipment is required, and so on. In some cases, certain components need replacement, *e.g.*, a wheel bearing on a motor vehicle, to ensure the main piece of equipment (in this case a car) last for its design life. Different approaches have been developed to know how maintenance can be performed to ensure equipment reaches or exceeds its design life. In addition to waiting for a piece of equipment to fail (reactive maintenance) the other approaches are preventive maintenance, predictive maintenance, or reliability centered maintenance.

#### 8.3.1 Breakdown (Reactive) Maintenance

Breakdown maintenance is basically the 'run it till it breaks' maintenance mode. No actions or efforts are taken to maintain the equipment as the designer originally intended to ensure design life is reached. Studies as recent indicate that, this is still the predominant mode of maintenance.

Advantages to breakdown maintenance can be viewed as a double-edged sword. If we are dealing with new equipment, we can expect minimal incidents of failure. If our maintenance program is purely reactive, we will not expend manpower or incur capital cost until something breaks. Since we do not see any associated maintenance cost, we could view this period as saving money. In reality, during the time we believe we are saving maintenance and capital cost, we are really spending more money than we would have under a different maintenance approach. We are spending more money associated with capital cost because, while waiting for the equipment to break, we are shortening the life of the equipment resulting in more frequent replacement. We may incur cost upon failure of the primary device associated with its failure causing the failure of a secondary device. This is an increased cost we would not have experienced if our maintenance program was more proactive.

Our labour cost associated with repair will probably be higher than normal because the failure will most likely require more extensive repairs than would have been required if the piece of equipment had not been run to failure. Chances are the piece of equipment will fail during off hours or close to the end of the normal workday. If it is a critical piece of equipment that needs to be back on-line quickly, we will have to pay maintenance overtime cost. Since we expect to run equipment to failure, we will require a large material inventory of repair parts. This is a cost we could minimize under a different maintenance strategy.

**Advantages**

1. Involves low cost investment for maintenance.
2. Less staff is required.

**Disadvantages**

1. Increased cost due to unplanned downtime of equipment.
2. Increased labour cost, especially if overtime is needed.
3. Cost involved with repair or replacement of equipment.
4. Possible secondary equipment or process damage from equipment failure.
5. Inefficient use of staff resources.

**8.3.2 Preventive Maintenance**

Preventive maintenance can be defined as, "Actions performed on a time or machine-run-based schedule that detect, preclude, or mitigate degradation of a component or system with the aim of sustaining or extending its useful life through controlling degradation to an acceptable level."

Preventive maintenance is a means to increase the reliability of their equipment. By simply expending the necessary resources to conduct maintenance activities intended by the equipment designer, equipment life is extended and its reliability is increased. In addition to an increase in reliability, lot of amount will be saved over that of a program just using reactive maintenance. Studies indicate that this savings can amount to as much as 12% to 18% on the average.

**Advantages**

1. Cost effective in many capital intensive processes.
2. Flexibility allows for the adjustment of maintenance periodicity.
3. Increased component life cycle.
4. Energy savings.
5. Reduced equipment or process failure.
6. Estimated 12% to 18% cost savings over reactive maintenance program.

**Disadvantages**

1. Catastrophic failures still likely to occur.
2. Labour intensive.
3. Includes performance of unneeded maintenance.
4. Potential for incidental damage to components in conducting unneeded maintenance.

Depending on the facilities current maintenance practices, present equipment reliability, and facility downtime, there is little doubt that many facilities purely reliant on reactive maintenance could save much more than 18% by instituting a proper preventive maintenance program.

While preventive maintenance is not the optimum maintenance program, it does have several advantages over that of a purely reactive program. By performing the preventive maintenance

as the equipment designer envisioned, we will extend the life of the equipment closer to design. This translates into dollar savings. Preventive maintenance (lubrication, filter change, etc.) will generally run the equipment more efficiently resulting in dollar savings. While we will not prevent equipment catastrophic failures, we will decrease the number of failures. Minimizing failures translate into maintenance and capital cost savings.

### 8.3.3 Predictive Maintenance

Predictive maintenance can be defined as “Measurements that detect the onset of a degradation mechanism, thereby allowing causal stressors to be eliminated or controlled prior to any significant deterioration in the component physical state. Results indicate current and future functional capability”.

Basically, predictive maintenance differs from preventive maintenance by basing maintenance need on the actual condition of the machine rather than on some preset schedule. Preventive maintenance is time-based. Activities such as changing lubricant are based on time, like calendar time or equipment run time. For example, most people change the oil in their vehicles every 3,000 to 5,000 miles travelled. This is effectively basing the oil change needs on equipment run time. No concern is given to the actual condition and performance capability of the oil. It is changed because it is time. This methodology would be analogous to a preventive maintenance task. If, on the other hand, the operator of the car discounted the vehicle run time and had the oil analyzed at some periodicity to determine its actual condition and lubrication properties, he may be able to extend the oil change until the vehicle had travelled 10,000 miles. This is the fundamental difference between predictive maintenance and preventive maintenance, whereby predictive maintenance is used to define needed maintenance task based on quantified material/equipment condition.

There are many advantages of predictive maintenance. A well-orchestrated predictive maintenance program will eliminate catastrophic equipment failures. Schedule of maintenance activities can be made to minimize or delete overtime cost. It is possible to minimize inventory and order parts, as required, well ahead of time to support the downstream maintenance needs and optimize the operation of the equipment, saving energy cost and increasing plant reliability. Past studies have estimated that a properly functioning predictive maintenance program can provide a savings of 8% to 12% over a program utilizing preventive maintenance alone. Depending on a facility's reliance on reactive maintenance and material condition, it could easily recognize savings opportunities exceeding 30% to 40%. Independent surveys indicate the following industrial average savings resultant from initiation of a functional predictive maintenance program:

1. Return on investment—10 times
2. Reduction in maintenance costs—25% to 30%
3. Elimination of breakdowns—70% to 75%
4. Reduction in downtime—35% to 45%
5. Increase in production—20% to 25%.

**Advantages**

1. Increased component operational life/availability.
2. Allows for pre-emptive corrective actions.
3. Decrease in equipment or process downtime.
4. Decrease in costs for parts and labour.
5. Better product quality.
6. Improved worker and environmental safety.
7. Improved worker moral.
8. Energy savings.
9. Estimated 8% to 12% cost savings over preventive maintenance program.

**Disadvantages**

1. Increased investment in diagnostic equipment.
2. Increased investment in staff training.
3. Savings potential not readily seen by management.

**Concept of Reliability in Maintenance**

Reliability is the probability of survival under a given operating environment. For example, the time between consecutive failures of a refrigerator where continuous working is required is a measure of its reliability. If this time is more, the product is said to have high reliability.

In a textile mill, generally the light is maintained at a minimum specified level. To achieve this, let us assume that there are 100 bulbs in use and the guaranteed life time of these bulbs is 5000 hours. If we collect statistics about the number of bulbs survived till 5000 hours, we can compute the reliability of the bulbs. In this case,

$$\text{Reliability} = \text{Failurerate} = \frac{\text{Number of bulbs survived till the specified time limit}}{\text{Number of bulbs used}}$$

If the number of bulbs survived till 5000 hours is 80, then we can say that the reliability is 0.8 (*i.e.*, 80/100)

The reliability of railway signalling system, aircraft, and power plant are some of the interesting examples for demonstrating the reliability concept. In these cases, a failure will lead to heavy penalty.

The concept of reliability can be matched with systems concept. Generally, products/equipments will have many components which may function with serial relationship or parallel relationship. So, the individual component's reliability affects the reliability of the product. Hence, enough attention must be given at the design, stage such that the product's reliability is maximized. The cost of maintenance is also to be considered along with the reliability while improving it.

The general failure pattern of any product is given in Fig. 8.1. This is called bath-tub curve. In Fig. 8.1, there will be large number of failures in the early period. This is mainly due to non-alignment while shipping the product, or misfit while manufacturing (assembling), or very high initial friction between moving parts, etc.

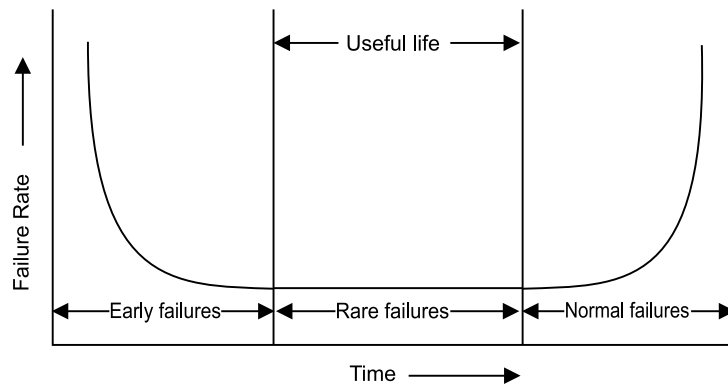

**Fig. 8.1** Product failure rate

### Reliability Improvement

The reliability of a system/product depends on many factors. So, we should concentrate at the grassroot level to improve product's reliability.

Some of the ways of improving systems reliability are listed below:

- Improved design of components
- Simplification of product structure
- Usage of better production equipments
- Better quality standards
- Better testing standards
- Sufficient number of standby units
- Usage of preventive maintenance if necessary at appropriate time.

## 8.4 MAINTENANCE PLANNING

Planning of maintenance jobs basically deals with answering two questions, 'what' and 'How' of the job; 'what activities are to be done?' and 'how those jobs and activities are to be done?' While answering these two questions, other supplementary questions are to be answered, *e.g.*, 'where the jobs is to be done?' and 'why the job is to be done?' etc., but all these will be helping in developing 'what' and 'how' of the job. It is very essential that engineering knowledge must be applied extensively to maintenance jobs for development of appropriate job plans using most suited techniques, tools materials and special facilities etc.

As the job planning forms the basic foundations, over which the efficiency and cost of actions depends, persons responsible for job planning should have adequate capabilities, such as, knowledge about jobs and available techniques, facilities and resources, analytical ability, conceptual logical ability and judgmental courage etc.

## Steps of Job Planning

The main steps to be followed for proper job planning are:

1. **Knowledge base:** It includes knowledge about equipment, job, available techniques, materials and facilities.
2. **Job investigation at site:** It gives a clear perception of the total jobs.
3. **Identify and document the work:** Knowing the earlier two steps and knowing the needs of preventive, predictive and other maintenance jobs.
4. **Development of repair plan:** Preparation of step by step procedures which would accomplish the work with the most economical use of time, manpower and material.
5. **Preparation tools and facilities list** indicating the needs of special tools, tackles and facilities needed.
6. **Estimation of time required to do the job** with work measurement technique and critical path analysis.

## 8.5 MAINTENANCE SCHEDULING

Scheduling is the function of coordinating all of the logistical issue around the issues regarding the execution phase of the work. Scheduled of maintenance jobs basically deals with answering two questions—‘Who’ and ‘When’ of job, *i.e.*, “who would do the job” and “when the job would be started and done”.

Effective scheduling essentially needs realistic thinking, based on substantial data and records. Majority of scheduling work needs to occur in areas such as overhead labour hours safety and toolbox meetings, break times and training times etc. Addition of corrective and approved improvement actions as dictated by the prioritization system and operations plan etc.

### Requirements for Schedulers

A scheduler should also have knowledge about job, techniques, facilities, analytical ability and judgmental courage. The scheduler must obtain knowledge/information about following ability and judgmental courage. The scheduler must obtain information about following facts, before starting his job:

1. Manpower availability by trade, location, shift, crew arrangement and permissible overtime limit etc.
2. Man hour back log on current or unfinished jobs.
3. Availability of the equipment or area where the work has to be performed.
4. Availability of proper tools, tackles, spares, consumables, structural and other required materials.
5. Availability of external manpower and their capabilities; these may be from other shops/ departments of the plant or from contractors (local, nearby, ancillary etc).
6. Availability of special equipments, jigs/fixtures, special lifting and handling facilities and cranes etc. This should also include labour and time saving devices like pneumatic hammers and excavators etc.



7. Starting date of the job; also often completion time of total job is predetermined and, in that case, resources are to be arranged accordingly.
8. Past schedules and charts (updated) if the same job has been done earlier, etc.

## 8.6 MAINTENANCE SCHEDULE TECHNIQUES

Different types of schedules are made suiting the respective job plans and different techniques are used for making and following those schedules. The first step of all scheduling is to break the job into small measurable elements, called activities and to arrange them in logical sequences considering the preceding, concurrent and succeeding activities so that a succeeding activity should follow preceding activities and concurrent activities can start together.

Arranging these activities in different fashion makes different types of schedules. They are as follows:

1. **Weekly general schedule** is made to provide weeks worth of work for each employee in an area.
2. **Daily schedule** is developed to provide a day's work for each maintenance employee of the area.
3. **Gantt charts** are used to represent the timings of tasks required to complete a project.
4. **Bar charts** used for technical analysis which represents the relative magnitude of the values.
5. **PERT/CPM** are used to find the time required for completion of the job and helps in the allocation of resources.

[Note: Discussed in detail in Chapter 5.]

### 8.6.1 Modern Scientific Maintenance Methods

**Reliability centered maintenance:** Reliability centered maintenance (RCM) is defined as “a process used to determine the maintenance requirements of any physical asset in its operating context”.

Basically, RCM methodology deals with some key issues not dealt with by other maintenance programs. It recognizes that all equipment in a facility is not of equal importance to either the process or facility safety. It recognizes that equipment design and operation differs and that different equipment will have a higher probability to undergo failures from different degradation mechanisms than others. It also approaches the structuring of a maintenance program recognizing that a facility does not have unlimited financial and personnel resources and that the use of both need to be prioritized and optimized. In a nutshell, RCM is a systematic approach to evaluate a facility's equipment and resources to best mate the two and result in a high degree of facility reliability and cost-effectiveness.

RCM is highly reliant on predictive maintenance but also recognizes that maintenance activities on equipment that is inexpensive and unimportant to facility reliability may best be left to a reactive maintenance approach. The following maintenance program breakdowns of continually

top-performing facilities would echo the RCM approach to utilize all available maintenance approaches with the predominant methodology being predictive.

- <10% Reactive
- 25% to 35% Preventive
- 45% to 55% Predictive.

Because RCM is so heavily weighted in utilization of predictive maintenance technologies, its program advantages and disadvantages mirror those of predictive maintenance. In addition to these advantages, RCM will allow a facility to more closely match resources to needs while improving reliability and decreasing cost.

### **Advantages**

- (a) Can be the most efficient maintenance program.
- (b) Lower costs by eliminating unnecessary maintenance or overhauls.
- (c) Minimize frequency of overhauls.
- (d) Reduced probability of sudden equipment failures.
- (e) Able to focus maintenance activities on critical components.
- (f) Increased component reliability.
- (g) Incorporates root cause analysis.

### **Disadvantages**

- (a) Can have significant startup cost, training, equipment, etc.
- (b) Savings potential not readily seen by management.

### **How to Initiate Reliability Centered Maintenance?**

The road from a purely reactive program to a RCM program is not an easy one. The following is a list of some basic steps that will help to get moving down this path.

1. Develop a master equipment list identifying the equipment in your facility.
2. Prioritize the listed components based on importance to process.
3. Assign components into logical groupings.
4. Determine the type and number of maintenance activities required and periodicity using:
  - Manufacturer technical manuals
  - Machinery history
  - Root cause analysis findings—Why did it fail?
  - Good engineering judgment
5. Assess the size of maintenance staff.
6. Identify tasks that may be performed by operations maintenance personnel.
7. Analyze equipment failure modes and effects.
8. Identify effective maintenance tasks or mitigation strategies.

### 8.6.2 Six Sigma Maintenance

It is the application of six sigma principles in maintenance. Six sigma is a maintenance process that focuses on reducing the variation in business production processes. By reducing variation, a business can achieve tighter control over its operational systems, increasing their cost effectiveness and encouraging productivity breakthrough.

Six sigma is a term created at Motorola to describe the goal and process used to achieve breakthrough levels of quality improvement. Sigma is the Greek symbol used by statisticians to refer to the six standard deviations. The term six sigma refers to a measure of process variation (six standard deviations) that translates into an error or defect rate of 3.4 parts per million. To achieve quality performance of six sigma level, special sets of quality improvement methodologies and statistical tools developed. These improvement methods and statistical tools are taught to a small group of workmen known as six sigma champions who are assigned full-time responsibility to define, measure, analyze, improve and control process quality. They also facilitate the improvement process by removing the organizational roadblocks encountered. Six sigma methodologies improve any existing business process by constantly reviewing and re-tuning the process. To achieve this, six sigma uses a methodology known as DMAIC (Define opportunities, Measure performance, Analyse opportunity, Improve performance, Control performance). This six sigma process is also called DMAIC process.

Six sigma relies heavily on statistical techniques to reduce failures and it incorporates the basic principles and techniques used in Business, Statistics, and Engineering. Six sigma methodologies can also be used to create a brand new business process from ground up using design for six sigma principles.

#### **SIX SIGMA MAINTENANCE PROCESS**

The steps of six sigma maintenance are same as DMAIC process. To apply six sigma in maintenance, the work groups that have a good understanding of preventive maintenance techniques in addition to a strong leadership commitment. Six sigma helps in two principal inputs to the maintenance cost equation: Reduce or eliminate the need to do maintenance (reliability of equipment), and improve the effectiveness of the resources needed to accomplish maintenance. Following are the steps involved in six sigma maintenance process.

#### **Define**

This step involves determining benchmarks, determining availability and reliability requirements, getting customer commitments and mapping the flow process.

#### **Measure**

This step involves development of failure measurement techniques and tools, data collection process, compilation and display of data.

#### **Analysis**

This step involves checking and verifying the data and drawing conclusions from data. It also involves determining improvement opportunities, finding root causes and map causes.

#### **Improve**

This step involves creating model equipment and maintenance process, total maintenance plan and schedule and implementing those plans and schedule.

## Control

This step involves monitoring the improved programme. Monitor improves performance and assesses effectiveness and will make necessary adjustments for the deviation if exists.

### 8.6.3 Enterprise Asset Management (EAM)

**Enterprise asset management** is an information management system that connects all departments and disciplines within a company making them an integrated unit. EAM is also referred as computerised maintenance management system. It is the organized and systematic tracking of an organization's physical assets *i.e.*, its plant, equipment and facilities. EAM aims at best utilisation of its physical assets. It ensures generation of quality data and timely flow of required data throughout the organization. EAM reduces paper work, improves the quality, quantity and timeliness of the information and provides information to technicians at the point of performance and gives workers access to job specific information at the work site.

### 8.6.4 Lean Maintenance

**Lean maintenance** is the application of lean principle in maintenance environments. Lean system recognises seven forms of waste in maintenance. They are over production, waiting, transportation, process waste, inventory, waste motion and defects. In lean maintenance, these wastes are identified and efforts are made for the continuous improvement in process by eliminating the wastes. Thus, lean maintenance leads to maximise yield, productivity and profitability.

Lean maintenance is basically equipment reliability focussed and reduces need for maintenance troubleshooting and repairs. Lean maintenance protects equipments and system from the route causes of malfunctions, failures and downtime stress. From the sources of waste uptime can be improved and cost can be lowered for maintenance.

### 8.6.5 Computer Aided Maintenance

For effective discharge of the maintenance function, a well designed information system is an essential tool. Such systems serve as effective decision support tools in the maintenance planning and execution. For optimal maintenance scheduling, large volume of data pertaining to men, money and equipment is required to be handled. This is a difficult task to be performed manually. For a planned and advanced maintenance system use of computers is essential. Here programmes are prepared to have an available inputs processed by the computer. Such a computer based system can be used as and when required for effective performance of the maintenance tasks. There are wide varieties of software package available in the market for different types of maintenance systems.

A computerised maintenance system includes the following aspects:

- Development of a database
- Analysis of past records if available
- Development of maintenance schedules
- Availability of maintenance materials

- Feedback control system
- Project management.

Following are some computer based maintenance systems which can be implemented:

**Job card system:** It is essential to prepare a job card for each component to record the maintenance work carried out or the work to be done. Job card shows the plant code, equipment code, the job code, the nature of the jobs, the start time and finishing time of the card, man-hour spent and etc. The use of computers facilitates the issue of job cards, recording of job history and control of manpower.

**Spare part life monitoring system:** Under this system, information about a spare part such as its description, anticipated life and date of its installation in equipment is recorded. As and when a particular sparepart is replaced during breakdown failures or scheduled maintenance, the updating of this information is done in their respective files stored in the computer. This helps to prepare the following reports:

- Spares repeatability in various machines indicating the performance of such spare parts.
- Comparisons of the actual life with the estimated life of the spare parts.

**Spare parts tracking system:** In most of the cases maximum time is consumed in procurement of spare parts. The total time required to rectify the breakdown is summation of the time to identify the cause of the failure, time to determine the requirements of spare parts, time to procure spare parts and the time to rectify the failure. In a computerised system, the spare part tracking system is beneficial in getting required material at the earliest. A spare part file is created that contains the information about the material code, spare part identification number, the assembly or sub-assembly number and the place where the spare part is used. This helps in knowing the current position about a particular spare part and facilitates timely requirement for future demands.

## 8.7 TOTAL PRODUCTIVE MAINTENANCE (TPM)

Total productive maintenance (TPM) is a maintenance program, which involves a newly defined concept for maintaining plants and equipment. The goal of the TPM program is to markedly increase production while, at the same time, increasing employee morale and job satisfaction. It can be considered as the medical science of machines.

TPM brings maintenance into focus as a necessary and vitally important part of the business. It is no longer regarded as a non-profit activity. Downtime for maintenance is scheduled as a part of the manufacturing day and, in some cases, as an integral part of the manufacturing process. The goal is to hold emergency and unscheduled maintenance to a minimum.

TPM was introduced to achieve the following objectives. The important ones are listed below.

- Avoid wastage in a quickly changing economic environment.
- Producing goods without reducing product quality.
- Reduce cost.

- Produce a low batch quantity at the earliest possible time.
- Goods sent to the customers must be non-defective.

**8.7.1 Similarities and Differences between TQM and TPM**

The TPM program closely resembles the popular Total Quality Management (TQM) program. Many of the tools such as, employee empowerment, benchmarking, documentation, etc. used in TQM are used to implement and optimize TPM. Following are the similarities between the two:

1. Total commitment to the program by upper level management is required in both programmes,
2. Employees must be empowered to initiate corrective action, and
3. A long-range outlook must be accepted as TPM may take a year or more to implement and is an on-going process. Changes in employee mind-set toward their job responsibilities must take place as well.

The differences between TQM and TPM are summarized below.

<i>Category</i>	<i>TQM</i>	<i>TPM</i>
Object	Quality (Output and effects)	Equipment (Input and cause)
Mains of attaining goal	Systematize the management. It is software oriented	Employees participation and it is hardware oriented
Target	Quality for PPM	Elimination of losses and wastes.

**8.7.2 Pillars of TPM**

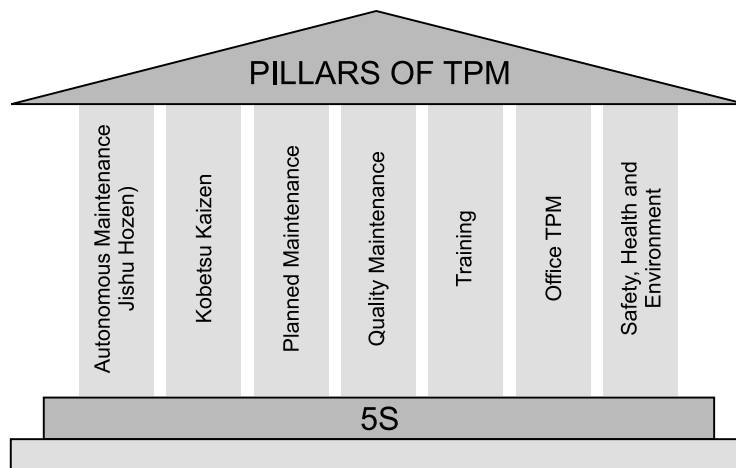

**PILLAR 1-5S**

TPM starts with 5S. Problems cannot be clearly seen when the work place is unorganized. Cleaning and organizing the workplace helps the team to uncover problems. Making problems visible is the first step of improvement.

<i>Japanese term</i>	<i>English translation</i>	<i>Equivalent 'S' term</i>
Seiri	Organization	Sort
Seiton	Tidiness	Systematise
Seiso	Cleaning	Sweep
Seiketsu	Standardisation	Standardise
Shitsuke	Discipline	Self-discipline

**SEIRI—Sort out**

This means sorting and organizing the items as critical, important, frequently used items, useless, or items that are not need as of now. Unwanted items can be salvaged. Critical items should be kept for use nearby and items that are not be used in near future, should be stored in some place. For this step, the worth of the item should be decided based on utility and not cost. As a result of this step, the search time is reduced.

Priority	Frequency of use	How to use
Low	Less than once per year, Once per year<	Throw away, Store away from the workplace
Average	At least 2/6 months, Once per month, Once per week	Store together but offline
High	Once per day	Locate at the workplace

**SEITON—Organise**

The concept here is that “Each items has a place, and only one place”. The items should be placed back after usage at the same place. To identify items easily, name plates and coloured tags has to be used. Vertical racks can be used for this purpose, and heavy items occupy the bottom position in the racks.

**SEISO—Shine the Workplace**

This involves cleaning the work place free of burrs, grease, oil, waste, scrap etc. No loosely hanging wires or oil leakage from machines.

**SEIKETSU—Standardization**

Employees has to discuss together and decide on standards for keeping the work place/ machines/pathways neat and clean. This standards are implemented for whole organization and are tested/inspected randomly.

**SHITSUKE—Self-discipline**

Considering 5S as a way of life and bring about self-discipline among the employees of the organization. This includes wearing badges, following work procedures, punctuality, dedication to the organization etc.

**PILLAR 2—JISHU HOZEN (AUTONOMOUS MAINTENANCE)**

This pillar is geared towards developing operators to be able to take care of small maintenance tasks, thus freeing up the skilled maintenance people to spend time on more value added activity

and technical repairs. The operators are responsible for upkeep of their equipment to prevent it from deteriorating.

### Steps in JISHU HOZEN

1. **Train the employees:** Educate the employees about TPM, its advantages, JH advantages and steps in JH. Educate the employees about abnormalities in equipments.

#### 2. Initial cleanup of machines

- Supervisor and technician should discuss and set a date for implementing step 1.
- Arrange all items needed for cleaning.
- On the arranged date, employees should clean the equipment completely with the help of maintenance department.
- Dust, stains, oils and grease has to be removed.
- Following are the things that have to be taken care while cleaning. They are oil leakage, loose wires, unfastened nuts and bolts and worn out parts.
- After clean up problems are categorized and suitably tagged. White tags are place where operators can solve problems. Pink tag is placed where the aid of maintenance department is needed.
- Contents of tag are transferred to a register.
- Make note of area, which were inaccessible.
- Finally close the open parts of the machine and run the machine.

#### 3. Counter measures

- Inaccessible regions had to be reached easily, *e.g.*, if there are many screw to open a flywheel door, hinge door can be used. Instead of opening a door for inspecting the machine, acrylic sheets can be used.
- To prevent work out of machine parts necessary action must be taken.
- Machine parts should be modified to prevent accumulation of dirt and dust.

#### 4. Tentative standard

- JH schedule has to be made and followed strictly.
- Schedule should be made regarding cleaning, inspection and lubrication and it also should include details like when, what and how.

#### 5. General inspection

- The employees are trained in disciplines like pneumatics, electrical, hydraulics, lubricant and coolant, drives, bolts, nuts and safety.
- This is necessary to improve the technical skills of employees and to use inspection manuals correctly.
- After acquiring this new knowledge the employees should share this with others.
- By acquiring this new technical knowledge, the operators are now well aware of machine parts.



### 6. Autonomous inspection

- New methods of cleaning and lubricating are used.
- Each employee prepares his own autonomous chart/schedule in consultation with supervisor.
- Parts which have never given any problem or part which don't need any inspection are removed from list permanently based on experience.
- Including good quality machine parts. This avoid defects due to poor JH.
- Inspection that is made in preventive maintenance is included in JH.
- The frequency of cleanup and inspection is reduced based on experience.

### 7. Standardization

- Up to the previous stem only the machinery/equipment was the concentration. However, in this step the surroundings of machinery are organized. Necessary items should be organized, such that there is no searching and searching time is reduced.
- Work environment is modified such that there is no difficulty in getting any item.
- Everybody should follow the work instructions strictly.
- Necessary spares for equipments is planned and procured.

### 8. Autonomous management

- OEE and OPE and other TPM targets must be achieved by continuous improve through Kaizen.
- PDCA (Plan, Do, Check and Act) cycle must be implemented for Kaizen.

## PILLAR 3—KAIZEN

'Kai' means change, and 'Zen' means good (for the better). Basically Kaizen is for small improvements, but carried out on a continual basis and involve all people in the organization. Kaizen is opposite to big spectacular innovations. Kaizen requires no or little investment. The principle behind is that "a very large number of small improvements are more effective in an organizational environment than a few improvements of large value." This pillar is aimed at reducing losses in the workplace that affect our efficiencies. By using a detailed and thorough procedure we eliminate losses in a systematic method using various Kaizen tools. These activities are not limited to production areas and can be implemented in administrative areas as well.

### Kaizen Policy

1. Practice concepts of zero losses in every sphere of activity.
2. Relentless pursuit to achieve cost reduction targets in all resources.
3. Relentless pursuit to improve overall plant equipment effectiveness.
4. Extensive use of PM analysis as a tool for eliminating losses.
5. Focus of easy handling of operators.

### Kaizen Target

Achieve and sustain zero loses with respect to minor stops, measurement and adjustments, defects and unavoidable downtimes. It also aims to achieve 30% manufacturing cost reduction.



3. Corrective maintenance
4. Maintenance prevention

With planned maintenance, we evolve our efforts from a reactive to a proactive method and use trained maintenance staff to help train the operators to better maintain their equipment.

### **Policy**

1. Achieve and sustain availability of machines;
2. Optimum maintenance cost;
3. Reduces spares inventory; and
4. Improve reliability and maintainability of machines.

### **Target**

1. Zero equipment failure and breakdown;
2. Improve reliability and maintainability by 50%;
3. Reduce maintenance cost by 20%; and
4. Ensure availability of spares all the time.

### **Six Steps in Planned Maintenance**

1. Equipment evaluation and recoding present status;
2. Restore deterioration and improve weakness;
3. Building up information management system;
4. Prepare time based information system, select equipment, parts and members and map out plan;
5. Prepare predictive maintenance system by introducing equipment diagnostic techniques; and
6. Evaluation of planned maintenance.

## **PILLAR 5—QUALITY MAINTENANCE**

It is aimed towards customer delight through highest quality through defect free manufacturing. Focus is on eliminating non-conformances in a systematic manner, much like Focused Improvement. We gain understanding of what parts of the equipment affect product quality and begin to eliminate current quality concerns, then move to potential quality concerns. Transition is from reactive to proactive (Quality Control to Quality Assurance).

QM activities is to set equipment conditions that preclude quality defects, based on the basic concept of maintaining perfect equipment to maintain perfect quality of products. The conditions are checked and measure in time series to very that measure values are within standard values to prevent defects. The transition of measured values is watched to predict possibilities of defects occurring and to take counter measures before hand.

### **Policy**

1. Defect free conditions and control of equipments;
2. QM activities to support quality assurance;

3. Focus of prevention of defects at source;
4. Focus on poka-yoke (fool proof system);
5. In-line detection and segregation of defects; and
6. Effective implementation of operator quality assurance.

**Target**

1. Achieve and sustain customer complaints at zero;
2. Reduce in-process defects by 50%; and
3. Reduce cost of quality by 50%.

**Data Requirements**

Quality defects are classified as *customer end* defects and *in house* defects. For customer-end data, we have to get data on:

1. Customer end line rejection; and
2. Field complaints.

In-house, data include data related to products and data related to process.

**Data Related to Product**

1. Product-wise defects;
2. Severity of the defect and its contribution—major/minor;
3. Location of the defect with reference to the layout;
4. Magnitude and frequency of its occurrence at each stage of measurement;
5. Occurrence trend in beginning and the end of each production/process/changes (like pattern change, ladle/furnace lining etc.); and
6. Occurrence trend with respect to restoration of breakdown/modifications/periodical replacement of quality components.

**Data Related to Processes**

1. The operating condition for individual sub-process related to men, method, material and machine;
2. The standard settings/conditions of the sub-process; and
3. The actual record of the settings/conditions during the defect occurrence.

**PILLAR 6—TRAINING**

It is aimed to have multi-skilled revitalized employees whose morale is high and who has eager to come to work and perform all required functions effectively and independently. Education is given to operators to upgrade their skill. It is not sufficient know only 'Know-How' by they should also learn 'Know-Why'. By experience they gain, 'Know-How' to overcome a problem what to be done. This they do without knowing the root cause of the problem and why they are doing so. Hence, it becomes necessary to train them on knowing 'Know-Why'. The employees should be trained to achieve the four phases of skill. The goal is to create a factory full of experts. The different phase of skills is:

Phase 1: Do not know.

Phase 2: Know the theory but cannot do.

Phase 3: Can do but cannot teach.

Phase 4: Can do and also teach.

### **Policy**

1. Focus on improvement of knowledge, skills and techniques;
2. Creating a training environment for self-learning based on felt needs;
3. Training curriculum/tools/assessment etc. conducive to employee revitalization; and
4. Training to remove employee fatigue and make work enjoyable.

### **Target**

1. Achieve and sustain downtime due to want men at zero on critical machines;
2. Achieve and sustain zero losses due to lack of knowledge/skills/techniques; and
3. Aim for 100% participation in suggestion scheme.

### **Steps in Educating and Training Activities**

1. Setting policies and priorities and checking present status of education and training;
2. Establish of training system for operation and maintenance skill upgradation;
3. Training the employees for upgrading the operation and maintenance skills;
4. Preparation of training calendar;
5. Kick-off of the system for training; and
6. Evaluation of activities and study of future approach.

### **PILLAR 7—OFFICE TPM**

Office TPM should be started after activating four other pillars of TPM (JH, KK, QM, PM). Office TPM must be followed to improve productivity, efficiency in the administrative functions and identify and eliminate losses. This includes analyzing processes and procedures towards increased office automation. Office TPM addresses twelve major losses. They are:

1. Processing loss;
2. Cost loss including in areas such as, procurement, accounts, marketing, sales leading to high inventories;
3. Communication loss;
4. Idle loss;
5. Set-up loss;
6. Accuracy loss;
7. Office equipment breakdown;
8. Communication channel breakdown, telephone and fax lines;
9. Time spent on retrieval of information;
10. Non availability of correct on-line stock status;

11. Customer complaints due to logistics; and
12. Expenses on emergency dispatches/purchases.

### **Office TPM and its Benefits**

1. Involvement of all people in support functions for focusing on better plant performance;
2. Better utilized work area;
3. Reduce repetitive work;
4. Reduced inventory levels in all parts of the supply chain;
5. Reduced administrative costs;
6. Reduced inventory carrying cost;
7. Reduction in number of files;
8. Reduction of overhead costs (to include cost of non-production/non-capital equipment);
9. Productivity of people in support functions;
10. Reduction in breakdown of office equipment;
11. Reduction of customer complaints due to logistics;
12. Reduction in expenses due to emergency dispatches/purchases;
13. Reduced manpower; and
14. Clean and pleasant work environment.

### **PILLAR 8—SAFETY, HEALTH AND ENVIRONMENT**

#### **Target**

1. Zero accident,
2. Zero health damage, and
3. Zero fires.

In this area focus is on to create a safe workplace and a surrounding area that is not damaged by our process or procedures. This pillar will play an active role in each of the other pillars on a regular basis.

A committee is constituted for this pillar, which comprises representative of officers as well as workers. The committee is headed by senior vice President (Technical). Utmost importance to safety is given in the plant. Manager (safety) is looking after functions related to safety. To create awareness among employees various competitions like safety slogans, quiz, drama, posters, etc. related to safety can be organized at regular intervals.

Today, with competition in industry at an all time high, TPM may be the only thing that stands between success and total failure for some companies. It has been proven to be a program that works. It can be adapted to work not only in industrial plants, but also in construction, building maintenance, transportation, and in a variety of other situations. Employees must be educated and convinced that TPM is not just another 'program of the month' and that management is totally committed to the program and the extended time frame necessary for full implementation. If everyone involved in a TPM program does his or her part, an unusually high rate of return compared to resources invested may be expected.

## EXERCISES

### Section A

1. Define maintenance.
2. What is reactive maintenance?
3. What is preventive maintenance?
4. What is predictive maintenance?
5. What is maintenance planning?
6. What is scheduling?
7. What is reliability centred maintenance?
8. What is six sigma maintenance?

### Section B

1. Explain the steps of job planning.
2. What are the requirements of schedules?
3. What are the maintenance techniques used?
4. Explain the six sigma maintenance process.

### Section C

1. Discuss the different types of maintenance.
2. Discuss the enterprise asset management.

### Skill development

**FAST FOOD RESTAURANT VISIT:** Get the information for the following questions:

1. Method of maintenance of equipment. (i.e. preventive maintenance or Breakdown maintenance)
2. Maintenance schedule followed.

# 9

## WASTE MANAGEMENT

### CHAPTER OUTLINE

9.1 *Introduction and Meaning*

9.2 *Reasons for Generation and Accumulation of Obsolete, Surplus and Scrap Items*

9.3 *Identification and Control of Waste*

9.4 *Disposal of Scrap*  
• *Exercises*  
• *Skill Development*

### 9.1 INTRODUCTION AND MEANING

The industrial waste and scrap consists of spoiled raw-materials, rejected components, defective parts, waste from production departments etc. involves some commercial values. They should be disposed of periodically and proper credit of the amount should be taken in the books of accounts. Hence, waste management places an important role in managing operations. Wastes can be categorised into obsolete, surplus and scrap items.

1. **Obsolete items:** These are those materials and equipments which are not damaged and which have economic worth but which are no longer useful for the Company's operation owing to many reasons such as, changes in product line, process, materials, and so on.

2. **Surplus items:** These are those materials and equipments which have no immediate use but have accumulated due to faulty planning, forecasting and purchasing. However, they have a usage value in future.

3. **Scrap:** It is defined as process wastage, such as, turnings, borings, sprues and flashes. They may have an end-use within the plant having commercial values. Hence, should be disposed of periodically.

### 9.2 REASONS FOR GENERATION AND ACCUMULATION OF OBSOLETE, SURPLUS AND SCRAP ITEMS

Following are the reasons for the generation and accumulation of obsolete, surplus and scrap items:

1. **Changes in product design:** This may lead to some items getting invalid so far as the final product is concerned. Hence, the entire stock of such items as surplus obsolete.



2. **Rationalization:** Sometimes raw materials are renationalized so as to minimise variety and simplify procurement. The rationalization process renders some items as surplus or obsolete.

3. **Cannibalization:** When a machine breakdown occurs, sometimes it is rectified using parts of an identical machine which is not functioning due to various reasons. This process of 'cannibalization' is not uncommon in many project-based industries. When continued unchecked, this results in obsolete and scrap items.

4. **Faulty planning and forecasting:** The marketing department may have projected a sales forecast which might be on the higher side. Any material planning has to be based on sales forecasts and this could result in surplus items. Wrong indenting by the user departments also leads to accumulation.

5. **Faulty purchase practices:** Sub-optimizing decisions like buying in bulk to take care of discounts and transportation economy without taking into account factors such as, shelf life, storage space requirements and technological changes once again lead to the accumulation of surplus and obsolete stocks.

6. **Other causes:** Many items are held as insurable spares for many years without any consumption. Faulty store-keeping methods, without adequate preservation, lead to spoilage. Inferior materials handling, improper codification and poor manufacturing methods also result in obsolete, surplus and scrap items. Poor maintenance of machine tools may result in excessive tools wear and greater process scrap.

### 9.3 IDENTIFICATION AND CONTROL OF WASTE

The combing process of combining the stock records and movement analysis has been found very effective in locating such stocks in the total inventory. Stock issue cards should be combed and items which have not been consumed (non-moving) for a period of one year must be isolated. A list of such items and their value in terms of money and time must be made. Similarly, such lists must be prepared for items which have not moved for 2 years, 3 years, 5 years and above. Such lists can then be put up to top management for disposal action. Care must be taken to prepare a separate list of imported spares and insurance items. Such combing and movement analysis must be done on a continuous basis. A typical movement analysis statement is shown in Exhibit 9.1.

**EXHIBIT 9.1 Movement analysis statement**

<i>Sl. No.</i>	<i>Part number description</i>	<i>A B C</i>	<i>Last data of issue</i>	<i>Stock on hand in number of days consumption</i>	<i>Value of orders on hand</i>

Whenever changes in production programme, design and product lines are contemplated, a senior executive from materials management must definitely be kept in the picture. This helps in several ways. He is in a position to inform top management of the amount of stock of materials on hand that are likely to be rendered obsolete if and when the changes are introduced. This could even guide the management as to when the changes could be made so that the existing

stock can be consumed in full. The materials manager in turn can freeze further orders for such materials and try to negotiate with the suppliers to take back the stock. For some items he can introduce the buy-back clause wherein the suppliers takes back items not consumed within a specific period. For new items which may be required, he can try to develop sources and place orders so that changes can be expeditiously introduced. All this highlights that a close coordination is required in order to avoid stock piling obsolete and surplus items. Selective control based on ABC analysis, accurate forecasting techniques and proper preservation minimise such accumulation. In the case of storage of perishable items the Central Warehousing Corporation has devised a scheme to enlarge its scope to cover certain specialized lines of storage. The schemes drawn up by the corporation include setting up a chain of cold storage plants for potatoes, and fruit, and storage facilities for certified seeds.

Many organizations have introduced formal documentation in introducing changes in design or product. It is called the 'Effective Point Advice.' This is popularly known as EPA. Here, the proposed changes, details of new materials and products required, details of materials and the products which will be invalid/obsolete when the change occurs and the approximate date when the change is expected to be introduced are detailed and circulated to concerned departments. EPA thereby helps in tapering off the stocks of 'invalid' items, cancellation of orders for such items, placing orders for buying and/or manufacturing new items and related activities. EPA systems help in better coordination for profitable introduction of changes with minimum 'side effects' such as the accumulation of obsolete items.

The reclamation of scrap has not attracted the attention of the top management in Indian Industry. Optimal utilization of scrap would allow conservation of the use of scarce natural resources, such as iron ore. This is because scrap is an important element which goes into the manufacture of steel and castings.

It is possible to salvage scrap for usage within the firm in some cases. Press parts are normally made from sheets and plates. The off-cuts generated during such process can be profitably utilized in making smaller press components such as washers. Rationalizing the supply size, changes in process such as reversing the dies may result in minimization of scrap. Big organizations have a full-fledged scrap salvaging department. These departments segregate the scrap into categories, like turnings, borings, plate cuttings, endpieces of billets, punching etc. Colour coding the scrap is also done to avoid the mixing of different categories of scrap. It is also advantageous to the end-users in each category and supply of scrap at the appropriate time for production. Often informing the production department at the right time about the volume of scrap generated enables prevention of excessive scrap through timely changes in production methods, tooling and materials.

#### **9.4 DISPOSAL OF SCRAP**

Disposal of scrap when handled in an imaginative manner can result in handsome returns to the organization. An effective disposal requires a compact disposal organization reporting to the materials manager, continuous market survey on the prices of various categories of scrap generated in the plant and constant touch with the industries which generate similar scrap and with the end-users.

Disposal action follows when the scrap cannot be utilised within the organization. In practice, it has been found that it is profitable to dispose the scrap directly to end-users rather than to middlemen who normally form a cartel of their own which leads to lower returns. Before disposal action it is essential that the scrap is segregated according to metal, size, etc. when the scrap

is mixed, the return is even lower than the lowest element in the mixture. This is because the buyer of scrap will have to segregate it at an extra cost. A cursory analysis of scrap prices will reveal that sheet and plate cuttings will fetch fewer amounts per a tonne compared to that of turnings and borings. Also when costly scrap such as copper, aluminium and tungsten are involved, it is imperative that they are segregated as returns are huge and price levels are different. Since scrap is generated process-wise, it comes out in a segregated condition and there should be no difficulty in sorting.

Auction and Tender methods are frequently used for disposal of scrap. Parties in both the cases are normally required to inspect the scrap in the scrap yard and deposit earnest money. Very often the company insists on a basic price depending upon the category of scrap. The disposal section works, in this aspect, in close coordination with the finance department. In many cases the disposal section may try to enter into a long-term contact with end-users such as steel plants.

Many companies have found to their displeasure scrapped components appearing in the market and competing with their parts as 'original equipment'. This is the price which organizations pay for not dismantling and disfiguring the scrap before disposal. Automobile spare parts and bearings especially are prone to such dangers. For this purpose some organizations go to the extent of requesting vehicle users to demolish filters and plugs before scrapping them. This is very important aspect.

In view of the paucity of raw materials and shortage of credit, it is necessary that optimum usage of materials is made and funds tied up in obsolete surplus and scrap items minimised. This is only possible when top management shows commitment and support. The employees of the organizations are naturally the best people to suggest improvements in materials, processes and new end users for scrap. It is they who can minimise the accumulation of scrap through coordination. Therefore, top management should work out formal reward systems to promote employee participation in this matter. A few organizations have suggestion box schemes which pay rich dividends to the organization. Employees, too get rewards and recognition in the process.

## EXERCISES

### Section A

1. What is obsolete items?
2. What is surplus items?
3. What is scrap?

### Section B

1. Explain the reason for generation and accumulation of obsolete, surplus and scrap items.

### Section C

1. Discuss the identification and control of waste.
2. Discuss the disposal of scrap.

### Skill development

**FAST FOOD RESTAURANT VISIT:** Get the information for the following questions:

1. Scraps, wastes and obsolete items in Restaurants.
2. Method of Disposal of wastes, scrap and obsolete items.

# 10

## AUTOMATION

### CHAPTER OUTLINE

10.1 <i>Introduction</i>	10.8 <i>Automated Flow Lines</i>
10.2 <i>Types of Automation</i>	10.9 <i>Automated Guided Vehicles Systems</i>
10.3 <i>Computer Integrated Manufacturing</i>	10.10 <i>Automated Storage/Retrieval Systems</i>
10.4 <i>Reasons for Automation</i>	10.11 <i>Carousel Storage Systems</i>
10.5 <i>Advantages of Automation</i>	10.12 <i>Carousel Storage Applications</i>
10.6 <i>Disadvantages of Automation</i>	• <i>Exercises</i>
10.7 <i>Automation Strategies</i>	• <i>Skill Development</i>
	• <i>Caselet</i>

### 10.1 INTRODUCTION

**Automation** is a technology concerned with the application of mechanical, electronic, and computer-based systems to operate and control production. This technology includes automatic machine tools to process parts, automatic assembly machines, industrial robots, automatic material handling and storage systems, automatic inspection systems for quality control, feedback control and computer process control, computer systems for planning, data collection and decision-making to support manufacturing activities.

### 10.2 TYPES OF AUTOMATION

Automated production systems can be classified into three basic types:

1. Fixed automation,
2. Programmable automation, and
3. Flexible automation.

### **1. FIXED AUTOMATION**

It is a system in which the sequence of processing (or assembly) operations is fixed by the equipment configuration. The operations in the sequence are usually simple. It is the integration and coordination of many such operations into one piece of equipment that makes the system complex. The typical features of fixed automation are:

- (a) High initial investment for custom-Engineered equipment;
- (b) High production rates; and
- (c) Relatively inflexible in accommodating product changes.

The economic justification for fixed automation is found in products with very high demand rates and volumes. The high initial cost of the equipment can be spread over a very large number of units, thus making the unit cost attractive compared to alternative methods of production. Examples of fixed automation include mechanized assembly and machining transfer lines.

### **2. PROGRAMMABLE AUTOMATION**

In this the production equipment is designed with the capability to change the sequence of operations to accommodate different product configurations. The operation sequence is controlled by a program, which is a set of instructions coded so that the system can read and interpret them. New programs can be prepared and entered into the equipment to produce new products. Some of the features that characterise programmable automation are:

- (a) High investment in general-purpose equipment;
- (b) Low production rates relative to fixed automation;
- (c) Flexibility to deal with changes in product configuration; and
- (d) Most suitable for batch production.

Automated production systems that are programmable are used in low and medium volume production. The parts or products are typically made in batches. To produce each new batch of a different product, the system must be reprogrammed with the set of machine instructions that correspond to the new product. The physical setup of the machine must also be changed over: Tools must be loaded, fixtures must be attached to the machine table also be changed machine settings must be entered. This changeover procedure takes time. Consequently, the typical cycle for given product includes a period during which the setup and reprogramming takes place, followed by a period in which the batch is produced. Examples of programmed automation include numerically controlled machine tools and industrial robots.

### **3. FLEXIBLE AUTOMATION**

It is an extension of programmable automation. A flexible automated system is one that is capable of producing a variety of products (or parts) with virtually no time lost for changeovers from one product to the next. There is no production time lost while reprogramming the system and altering the physical setup (tooling, fixtures, and machine setting). Consequently, the system can produce various combinations and schedules of products instead of requiring that they be made in separate batches. The features of flexible automation can be summarized as follows:

- (a) High investment for a custom-engineered system.
- (b) Continuous production of variable mixtures of products.

(c) Medium production rates.

(d) Flexibility to deal with product design variations.

The essential features that distinguish flexible automation from programmable automation are: (1) the capacity to change part programs with no lost production time; and (2) the capability to changeover the physical setup, again with no lost production time. These features allow the automated production system to continue production without the downtime between batches that is characteristic of programmable automation. Changing the part programs is generally accomplished by preparing the programs off-line on a computer system and electronically transmitting the programs to the automated production system. Therefore, the time required to do the programming for the next job does not interrupt production on the current job. Advances in computer systems technology are largely responsible for this programming capability in flexible automation. Changing the physical setup between parts is accomplished by making the changeover off-line and then moving it into place simultaneously as the next part comes into position for processing. The use of pallet fixtures that hold the parts and transfer into position at the workplace is one way of implementing this approach. For these approaches to be successful; the variety of parts that can be made on a flexible automated production system is usually more limited than a system controlled by programmable automation.

The relative positions of the three types of automation for different production volumes and product varieties are depicted in Fig. 10.1.

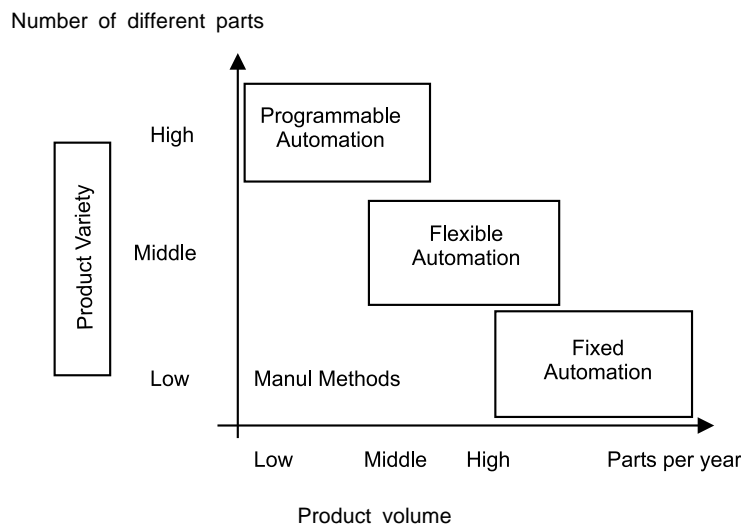

**Fig. 10.1** Types of production automation

### 10.3 COMPUTER INTEGRATED MANUFACTURING

The computers had done a dramatic impact on the development of production automation technologies. Nearly all modern production systems are implemented today using computer systems. The term computer integrated manufacturing (CIM) has been coined to denote the pervasive use of computers to design the products, plan the production, control the operations, and perform the

various business related functions needed in a manufacturing firm. Computer Aided Design and Computer Aided Manufacturing (CAD/CAM) in another term that is used synonymously with CIM.

The good relationship exists between automation and CIM with a conceptual model of manufacturing. In a manufacturing firm, the physical activities related to production that take place in the factory can be distinguished from the information-processing activities. The physical activities include all of the manufacturing processing, assembly, materials handling and inspections that are performed on the product. These operations come in direct contact with the physical activities during manufacture. Raw materials flow in one end of the factory and finished products flow out the other end. The physical activities (processing, handling, etc.) take place inside the factory. The information-processing functions form a ring that surrounds the factory, providing the data and knowledge required to produce the product successfully. These information processing functions include: (1) business activities, (2) product design, (3) manufacturing planning, and (4) manufacturing control. These four functions form a cycle of events that must accompany the physical production activities.

#### 10.4 REASONS FOR AUTOMATION

Following are some of the reasons for automation:

1. **Increased productivity:** Automation of manufacturing operations holds the promise of increasing the productivity of labour. This means greater output per hour of labour input. Higher production rates (output per hour) are achieved with automation than with the corresponding manual operations.

2. **High cost of labour:** The trend in the industrialized societies of the world has been toward ever-increasing labour costs. As a result, higher investment in automated equipment has become economically justifiable to replace manual operations. The high cost of labour is forcing business leaders to substitute machines for human labour. Because machines can produce at higher rates of output, the use of automation results in a lower cost per unit of product.

3. **Labour shortages:** In many advanced nations there has been a general shortage of labour. Labour shortages stimulate the development of automation as a substitute for labour.

4. **Trend of labour toward the service sector:** This trend has been especially prevalent in India. There are also social and institutional forces that are responsible for the trend. There has been a tendency for people to view factory work as tedious, demeaning, and dirty. This view has caused them to seek employment in the service sector of the economy government, insurance, personal services, legal, sales, etc. Hence, the proportion of the work force employed in manufacturing is reducing.

5. **Safety:** By automating the operation and transferring the operator from an active participation to a supervisory role, work is made safer.

6. **High cost of raw materials:** The high cost of raw materials in manufacturing results in the need for greater efficiency in using these materials. The reduction of scrap is one of the benefits of automation.

7. **Improved product quality:** Automated operations not only produce parts at faster rates but they produce parts with greater consistency and conformity to quality specifications.

8. **Reduced manufacturing lead time:** With reduced manufacturing lead time automation allows the manufacturer a competitive advantage in promoting good customer service.

9. **Reduction of in-process inventory:** Holding large inventories of work-in-process represents a significant cost to the manufacturer because it ties up capital. In-process inventory is of no value. It serves none of the purposes of raw materials stock or finished product inventory. Automation tends to accomplish this goal by reducing the time a workpart spends in the factory.

10. **High cost of not automating:** A significant competitive advantage is gained by automating a manufacturing plant. The benefits of automation show up in intangible and unexpected ways, such as, improved quality, higher sales, better labour relations, and better company image.

All of these factors act together to make production automation a feasible and attractive alternative to manual methods of manufacture.

## 10.5 ADVANTAGES OF AUTOMATION

Following are some of the advantages of automation:

1. Automation is the key to the shorter workweek. Automation will allow the average number of working hours per week to continue to decline, thereby allowing greater leisure hours and a higher quality life.
2. Automation brings safer working conditions for the worker. Since there is less direct physical participation by the worker in the production process, there is less chance of personal injury to the worker.
3. Automated production results in lower prices and better products. It has been estimated that the cost to machine one unit of product by conventional general-purpose machine tools requiring human operators may be 100 times the cost of manufacturing the same unit using automated mass-production techniques. The electronics industry offers many examples of improvements in manufacturing technology that have significantly reduced costs while increasing product value (*e.g.*, colour TV sets, stereo equipment, calculators, and computers).
4. The growth of the automation industry will itself provide employment opportunities. This has been especially true in the computer industry, as the companies in this industry have grown (IBM, Digital Equipment Corp., Honeywell, etc.), new jobs have been created. These new jobs include not only workers directly employed by these companies, but also computer programmers, systems engineers, and other needed to use and operate the computers.
5. Automation is the only means of increasing standard of living. Only through productivity increases brought about by new automated methods of production, it is possible to advance standard of living. Granting wage increases without a commensurate increase in productivity will result in inflation. To afford a better society, it is a must to increase productivity.

## 10.6 DISADVANTAGES OF AUTOMATION

Following are some of the disadvantages of automation:

1. Automation will result in the subjugation of the human being by a machine. Automation tends to transfer the skill required to perform work from human operators to machines.



In so doing, it reduces the need for skilled labour. The manual work left by automation requires lower skill levels and tends to involve rather menial tasks (*e.g.*, loading and unloading workpart, changing tools, removing chips, etc.). In this sense, automation tends to downgrade factory work.

2. There will be a reduction in the labour force, with resulting unemployment. It is logical to argue that the immediate effect of automation will be to reduce the need for human labour, thus displacing workers.
3. Automation will reduce purchasing power. As machines replace workers and these workers join the unemployment ranks, they will not receive the wages necessary to buy the products brought by automation. Markets will become saturated with products that people cannot afford to purchase. Inventories will grow. Production will stop. Unemployment will reach epidemic proportions and the result will be a massive economic depression.

## 10.7 AUTOMATION STRATEGIES

There are certain fundamental strategies that can be employed to improve productivity in manufacturing operations technology. These are referred as automation strategies.

1. **Specialization of operations:** The first strategy involves the use of special purpose equipment designed to perform one operation with the greatest possible efficiency. This is analogous to the concept of labour specializations, which has been employed to improve labour productivity.

2. **Combined operations:** Production occurs as a sequence of operations. Complex parts may require dozens, or even hundreds, of processing steps. The strategy of combined operations involves reducing the number of distinct production machines or workstations through which the part must be routed. This is accomplished by performing more than one operation at a given machine, thereby reducing the number of separate machines needed. Since each machine typically involves a setup, setup time can be saved as a consequence of this strategy. Material handling effort and nonoperation time are also reduced.

3. **Simultaneous operations:** A logical extension of the combined operations strategy is to perform at the same time the operations that are combined at one workstation. In effect, two or more processing (or assembly) operations are being performed simultaneously on the same workpart, thus reducing total processing time.

4. **Integration of operations:** Another strategy is to link several workstations into a single integrated mechanism using automated work handling devices to transfer parts between stations. In effect, this reduces the number of separate machines through which the product must be scheduled. With more than one workstation, several parts can be processed simultaneously, thereby increasing the overall output of the system.

5. **Increased flexibility:** This strategy attempts to achieve maximum utilisation of equipment for job shop and medium volume situations by using the same equipment for a variety of products. It involves the use of the flexible automation concepts. Prime objectives are to reduce setup time and programming time for the production machine. This normally translates into lower manufacturing lead time and lower work-in-process.

6. **Improved material handling and storage systems:** A great opportunity for reducing non-productive time exists in the use of automated material handling and storage systems. Typical benefits included reduced work-in-process and shorter manufacturing lead times.

7. **On-line inspection:** Inspection for quality of work is traditionally performed after the process. This means that any poor quality product has already been produced by the time it is inspected. Incorporating inspection into the manufacturing process permits corrections to the process as product is being made. This reduces scrap and brings the overall quality of product closer to the nominal specifications intended by the designer.

8. **Process control and optimization:** This includes a wide range of control schemes intended to operate the individual process and associated equipment more efficiency. By this strategy, the individual process times can be reduced and product quality improved.

9. **Plant operations control:** Whereas the previous strategy was concerned with the control of the individual manufacturing process, this strategy is concerned with control at the plant level of computer networking within the factory.

10. **Computer integrated manufacturing (CIM):** Taking the previous strategy one step further, the integration of factory operations with engineering design and many of the other business functions of the firm. CIM involves extensive use of computer applications, computer data bases, and computer networking in the company.

## 10.8 AUTOMATED FLOW LINES

An automated flow line consists of several machines or workstations which are linked together by work handling devices that transfer parts between the stations. The transfer of work parts occurs automatically and the workstations carry out their specialized functions automatically. The flow line can be symbolized as shown in Fig. 10.2. A raw workpart enters one end of the line and the processing steps are performed sequentially as the part moves from one station to the next. It is possible to incorporate buffer zones into the flow line, either at a single location or between every workstation. It is also possible to include inspection stations in the line to automatically perform intermediate checks on the quality of the workparts. Manual stations might also be located along the flow line to perform certain operations which are difficult or uneconomical to automate.

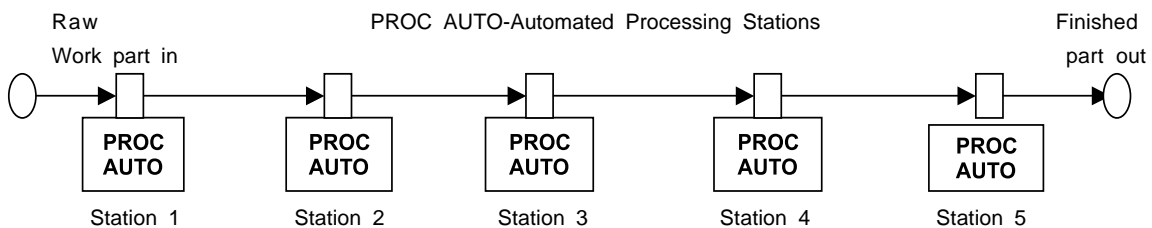

**Fig. 10.2** Configuration of an automated flow line

Automated flow lines are generally the most appropriate means of productions in cases of relatively stable product life; high product demand, which requires high rates of production; and where the alternative method of manufacture would invoice large labour content.

The objectives of the use of flow line automation are:

1. To reduce labour costs;
2. To increase production rates;
3. To reduce work-in-process;
4. To minimize distances moved between operations;
5. To achieve specialization of operations; and
6. To achieve integration of operations.

There are two general forms that the workflow can take. These two configurations are in-line and rotary.

### In-line Type

The in-line configuration consists of a sequence of workstations in a more-or-less straight line arrangement. The flow of work can take a few 90° turns, either for workpiece reorientation, factory layout limitations, or other reasons, and still qualify as a straight-line configuration. A common pattern of workflow, for example, is a rectangular shape, which would allow the same operator to load the starting workpiece and unload the finished workpiece.

### Rotary Type

In the rotary configuration, the workparts are indexed around a circular table or dial. The workstations are stationary and usually located around the outside periphery of the dial. The parts ride on the rotating table and are registered or positioned, in turn, at each station for its processing or assembly operation. This type of equipment is often referred to as an indexing machine or dial index machine and the configurations.

The choice between the two types of configurations depends on the application. The rotary type is commonly limited to smaller workpieces and to fewer stations. There is no flexibility in the design of the rotary configuration. The rotary configuration usually involves a lower-cost piece of equipment and typically requires less factory floor space. The in-line design is preferable for larger work pieces and can accommodate a larger number of workstations. In-line machines can be fabricated with a built-in storage capability to smooth out the effect of work stoppages at individual stations and other irregularities.

## 10.9 AUTOMATED GUIDED VEHICLES SYSTEMS

An automated or automatic guided vehicle system (AGVS) is a materials handling system that uses independently operated, self-propelled vehicles that are guided along defined pathways in the floor. The vehicles are powered by means of on-board batteries that allow operation for several hours (8 to 16 hours is typical) between recharging. The definition of the pathways is generally accomplished using wires embedded in the floor or reflective paint on the floor surface. Guidance is achieved by sensors on the vehicles that can follow the guide wires or paint.

### 10.9.1 Types of AGVS

The types of Automated Guided Vehicles Systems (AGVS) can be classified as follows:

1. **Driverless trains:** The type consists of a towing vehicle (which is the AGV) that pulls one or more trailers to form a train. It was the first type of AGVS to be introduced and is still popular. It is useful in applications where heavy payloads must be moved large distances in warehouses of factories with intermediate pickup and drop-off points along the route.

2. **AGVS pallet trucks:** Automated guided pallet trucks are used to move palletized loads along predetermined routes. In the typical application the vehicle is backed into the loaded pallet by a human worker who steers the truck and uses its forks to elevate the load slightly. Then the worker who steers the truck to the guide path, programs its destination, and the vehicle proceeds automatically to the destination for unloading. A more recent introduction related to the pallet truck is the forklift AGV. This vehicle can achieve significant vertical movement of its forks reach loads on shelves.

3. **AGVS unit load carriers:** This type of AGVS is used to move unit loads from one station to another station. They are often equipped for automatic loading and unloading by means of powered rollers, moving belts, mechanized lift platforms, or other devices. The light-load AGV is a relatively small vehicle with a corresponding light load capacity. It does not require the same large aisle width as the conventional AGV. Light-load guided vehicles are designed to move small loads through plants of limited size engaged in light manufacturing. The assembly line AGVS is designed to carry a partially completed subassembly through a sequence of assembly workstations to build the product.

AGVS technology is far from mature, and the industry, and the industry is continually working to develop new systems in response to new application requirements. An example of a new and evolving AGVS design involves the placement of a robotic manipulator on an automated guided vehicle to provide a mobile robot for performing complex handling tasks at various locations in a plant.

### 10.9.2 Applications of Automated Guided Vehicle Systems

Automated guided vehicle systems are used in a growing number and variety of applications. Its applications can be categorised into the following types:

1. **Driverless train operations:** These applications involve the movement of large quantities of materials over relatively large distances. For example, the moves are within a large warehouse or factory building, or between buildings in a large storage depot. For the movement of trains consisting of 5 to 10 trailers, this becomes an efficient handling method.

2. **Storage/Distribution systems:** Unit load carries and pallet trucks are typically used in these applications. These storage and distribution operations involve the movement of materials in unit loads (sometimes individual items are moved) from or to specific locations. The applications often interface the AGVS with some other automated handling or storage system, such as an automated storage/retrieval system (AS/RS) in a distribution centre. The AGVS delivers incoming items of unit loads from the receiving dock to the AS/RS, which places the items in storage, and the AS/RS retrieves individual pallet loads or items from storage and transfer them to vehicles

for delivery to the shipping dock. When the rates of incoming loads and the outgoing loads are in balance, this mode of operation permits loads to be carried in both directions by the AGVS vehicles, thereby increasing the handling system efficiency.

3. **Assembly line operations:** AGV systems are being used in a growing number of assembly-line applications. In these applications, the production rate is relatively low and there are a variety of different models made on the production line. Between the workstations, components are kitted and placed on the vehicle for the assembly operations that are to be performed on the partially completed product at the next station. The workstations are generally arranged in parallel configurations to add to the flexibility of the line. Unit load carries and light-load guided vehicles are the type of AGVS used in these assembly lines.

4. **Flexible manufacturing systems:** Another application of AGVS technology is in flexible manufacturing systems (FMS). In this application, the guided vehicles are used as the materials handling system in the FMS. The vehicles deliver work from the staging area (where work is placed on pallet fixtures, usually manually) to the individual workstations in the system. The vehicles also move work between stations in the manufacturing system. At a workstation, the work is transferred from the vehicle platform into the work area of the station for processing. At the completion of processing by that station a vehicle returns to pick up the work and transport it to the next area. AGV systems provide a versatile material handling system to complement the flexibility of the FMS operation.

*Example:* Using robots and automation together, manufacturing is carried out without using manpower (unmanned) from raw material to finished products.

5. **Miscellaneous applications:** Other applications of automated guided vehicle systems include non-manufacturing and non-warehousing applications, such as, mail delivery in office buildings and hospital material handling operations. Hospital guided vehicles transport meal trays, linen, medical and laboratory supplies, and other materials between various departments in the building. These applications typically require movement of the vehicles between different floors of the hospital and will use elevators for this purpose.

## 10.10

### AUTOMATED STORAGE/RETRIEVAL SYSTEMS

An automated storage/retrieval system (AS/RS) is defined by the Materials Handling Institute as, “A combination of equipment and controls which handles, stores and retrieves materials with precision, accuracy and speed under a defined degree of automation”.

AS/R systems are custom-planned for each individual application, and they range in complexity from relatively small mechanized systems that are controlled manually to very large computer-controlled systems that are fully integrated with factory and warehouse operations.

The AS/RS consists of a series of storage aisles that are serviced by one or more storage/retrieval (S/R) machines, usually one S/R machine per aisle. The aisles have storage racks for holding the materials to be stored. The S/R machines are used to deliver materials to the storage racks and to retrieve materials from the racks. The AS/RS has one or more input stations where materials are delivered for entry into storage and where materials are picked up from the system. The input/output stations are often referred to as pickup and deposit (P&D) stations in the terminology of AS/RS systems. The P&D stations can be manually operated or interfaced to some form of automated handling system, such as a conveyor system or AGVS.

### 10.10.1 Types of AS/RS

Several important categories of automated storage/retrieval systems can be distinguished. These include:

1. **Unit load AS/RS:** This is typically a large automated system designed to handle unit loads stored on pallets or other standard containers. The system is computer-controlled and the S/R machines are automated and designed to handle the unit load containers. The unit load system is the generic AS/RS.

2. **Miniload AS/RS:** This storage system is used to handle small loads (individual parts or supplies) that are contained in bins or drawers within the storage system. The S/R machine is designed to retrieve the bin and deliver it to a P&D station at the end of the aisle so that the individual items can be withdrawn from the bins. The bin or drawer is then returned to its location in the system. The miniload AS/RS system is generally smaller than the unit load AS/RS and is often enclosed for security of the items stored.

3. **Man-on-board AS/RS:** The man-on-board AS/RS system represents an alternative approach to the problem of storing and retrieving individual items in the system. Whereas the miniload system delivers the entire bin to the end-of aisle pick station, the man-on-board system permits the individual items to be picked directly at their storage locations. This offers an opportunity to reduce the transaction time of the system.

4. **Automated item retrieval system:** These systems are also designed for retrieval of individual items or small unit loads such as cases of product in a distribution warehouse. In this system, the items are stored in single-file lanes rather than in bins or drawer. When an item is to be retrieved, it is released from its lane onto a conveyor for delivery to the pickup station. The supply of items in each lane is generally replenished from the rear of the retrieval system, so that there is flow-through of the items, thus permitting first in first out (FIFO) inventory control.

5. **Deep-lane AS/RS:** The deep-lane AS/RS is a high density unit load storage system that is appropriate when large quantities are to be stored but the number of separate types of material is relatively small. Instead of storing each unit load so that it can be accessed directly from the aisle, the deep-lane system stores up to 10 or so loads in a single rack, one load behind the next. Each rack is designed for 'flow-through' with input on one side and output on the other side. Loads are picked from one side of the rack system by a special S/R type machine designed for retrieval and another special machine is used on the entry side of the rack system for input of loads.

### 10.10.2 Basic Components of an AS/RS

All automated storage/retrieval systems consist of certain basic building blocks. These components are:

- Storage structure
- Storage/retrieval (S/R) machine
- Storage modules (*e.g.*, pallets for unit loads)
- Pickup and deposit stations.

1. The **storage structure** is the fabricated steel framework that supports the loads contained in the AS/RS. The structure must possess sufficient strength and rigidity that it does not deflect significantly due to the loads in storage or other forces on the framework. The individual storage components in the structure must be designed so to accept and hold the storage modules used to contain the stored materials.
2. The **S/R machine** (sometimes called a crane) is used to accomplish a storage transaction, delivering loads from the input station into storage, or retrieving loads from storage and delivering them to the output station. To perform these transactions, the storage/retrieval machine must be capable of horizontal and vertical travel to align its carriage with the storage compartment in the storage structure, and it must also pull the load from or push the load into the storage compartment.
3. The **storage modules** are the containers of the stored material. Examples of storage modules include pallets, steel wire baskets and containers, tote pans, storage bins, and special drawers (used in miniload AS/RS systems). These modules are generally made to a standard base size that can be handled automatically by the carriage shuttle of the S/R machine.
4. The **pickup and deposit stations** are used to transfer loads to and from the AS/RS. They are generally located at the end of the aisles for access by the S/R machine and the external handling system that brings loads to the AS/RS and takes loads away. The pickup stations and deposit stations may be located at opposite ends of the storage aisle or combined at the same location. This depends on the origination point of the incoming loads and the destination of the output loads. The P&D stations must be designed so that they are compatible with the S/R machine shuttle and the external handling system.

## 10.11 CAROUSEL STORAGE SYSTEMS

A carousel storage system is series of bins or baskets fastened to carries that are connected together and revolve around a long, oval track system. The track system is similar to a trolley conveyor system. Its purpose is to position bins at a load/unload station at the end of the oval. The operation is similar to the powered overhead rack system used by dry cleaners to deliver finished garments to the front of the store. The typical operation of the storage carousel is mechanized rather than automated. The load/unload station is manned by a human worker who activates the powered carousel to deliver a desired bin to the station. One or more parts are removed from the bin, and the cycle is repeated.

Carousels come in a variety of sizes, ranging between 10 and 100 ft in length of the oval. As the length of the carousel is increased, the storage density increases, but the average transaction time (Storage or retrieval) decreases. Accordingly, the typical carousel size ranges perhaps between 30 and 50 ft to achieve a proper balance between these opposing factors.

## 10.12 CAROUSEL STORAGE APPLICATIONS

The carousel storage system provides for a relatively high throughout rate and is often an attractive to the miniload AS/RS in the following types of applications:

1. **Storage and retrieval operations:** In certain operations individual items must be selected from the group of item stored in the bin or basket. Sometimes called 'pick and load' operations, this type of procedure is common for order picking of service parts or other items in wholesale firm, tools in a toolroom, raw materials from a stockroom, and work-in-process in a factory. In small assembly operations such as electronics, carousels are used to accomplish kitting of parts that will be transported to the assembly workstations.

2. **Transport and accumulation:** These are applications in which the carousel is used to transport and sort materials as they are stored. One example of this is in progressive assembly operations where the workstations are located around the periphery of a continuously moving carousel and the workers have access to the individual storage bins of the carousel. They remove work from the bins to complete their own respective assembly tasks, and then place their work into another bin for the next operation at some other workstation.

3. **Unique applications:** These involve specialised uses of carousel storage systems. Examples include electrical testing of components, where the carousel is used to store the item during testing for a specified period of time; and drawer or cabinet storage, in which standard drawer-type cabinets are mounted on the carousel.

Storage carousels are finding an increasing number of applications in manufacturing operations, where it's relatively low cost, versatility, and high reliability have been acknowledged. It represents a competitive to the miniload AS/RS and other AS/RS configurations for work-in-progress storage in manufacturing plant.

## EXERCISES

### Section A

1. What do you mean by automation?
2. What is computer integrated manufacturing?
3. What is computer aided manufacturing?
4. What is AGVS?

### Section B

1. What are the advantage and disadvantage of automation?
2. Explain the types of AGVS.
3. Explain the application of automated guided vehicle systems.
4. What are the basic components of an AS/RS?
5. What are the application of AS/RS?

### Section C

1. Discuss different types of automation.
2. Discuss the reasons for automation.
3. Discuss the different strategies of automation.
4. Discuss the concept of automated flow line.
5. Discuss the concept of automated storage/retrieval system.



## Skill Development

**FAST FOOD RESTAURANT VISIT:** Get the information for the following questions:

1. Type of automation exists. (Flexibility or fixed)
2. Usage of automated guided vehicles if any.
3. How is the flow managed in automation (i.e. one or more workers).
4. Automated storage system (packing) if any.

### CASELET

The following are the case studies to understand the overall functions of productions and operations management:

#### 1. BRUEGGER'S BAGEL BAKERY

Bruegger's Bagel Bakery makes and sells a variety of bagels, including plain, onion, poppy seed, and cinnamon raisin, as well as assorted flavors of cream cheese. Bagels are the major source of revenue for the company.

The bagel business is a Rs.3 billion industry. Bagels are very popular with consumers. Not only are they relatively low in fat, they are filling, and they taste good! Investors like the bagel industries because it can be highly profitable: it only costs about Rs.10 to make a bagel, and they can be sold for Rs.50 each or more. Although some bagel companies have done poorly in recent years, due mainly to poor management, Bruegger's business is booming;

It is number one nationally, with over 450 shops that sell bagels, coffee, and bagel sandwiches for takeout or on premise consumption. Many stores in the Bruegger's chain generate an average of Rs.800, 000 in sales annually.

Production of bagels is done in batches, according to flavor, with each flavor being produced on a daily basis. Production of bagels at Bruegger's begins at a processing plant, where the basic ingredients of flour, water, yeast, and flavorings are combined in a special mixing machine. After the dough has been thoroughly mixed, it is transferred to another machine that shapes the dough into individual bagels. Once the bagels have been formed, they are loaded onto refrigerated trucks for shipping to individual stores. When the bagels reach a store, they are unloaded from the trucks and temporarily stored while they rise. The final two steps of processing involve boiling the bagels in a kettle of water and malt for one minute, and then baking the bagels in an oven for proximately 15 minutes. The process is depicted in Figure 1.

Quality is an important feature of a successful business. Customers judge the quality of bagels by their appearance (size, shape, and shine), taste, and consistency. Customers are also sensitive to the service they receive when they make their purchases. Bruegger's devotes careful attention to quality at every stage of operation, from choosing suppliers of ingredients, careful monitoring of ingredients, and keeping equipment in good operating condition to monitoring output at each step in the process. At the stores, employees are instructed to watch for deformed bagels and to remove them when they find them. (Deformed bagels are returned to the main plant where they are sliced into bagel chips, packaged, and then taken back to the stores for sale, thereby reducing the scrap rate.) Employees who work in the stores are carefully chosen and then trained so that they are competent to operate the necessary equipment in the stores and to provide the desired level of service to customers.

The company operates with minimal inventories of raw materials and inventories of partially completed bagels at the plant and very little inventory of bagels at the stores. One reason for this is to maintain a high degree of freshness in the final product by continually supplying fresh product to the stores. A second reason is to keep costs down; minimal inventories mean less space is needed for storage.

### Questions

1. Bruegger's maintains relatively little inventory at either its plants or its retail stores. List the benefits and risks of this policy.
2. Quality is very important to Bruegger's.
  - (a) What features of bagels do customers look at to judge their quality of bagels?
  - (b) At what points in the production process do workers check bagel quality?
  - (c) List the steps in the production process, beginning with purchasing ingredients, and ending with the sale, and state how quality can be positively affected at each step.
3. Which inventory models could be used for ordering the ingredients for bagels? Which model do you think would be most appropriate for deciding how many bagels to make in a given batch?
4. Bruegger's has bagel-making machines at its plants. Another possibility would be to have a bagel-making machine at each store, what advantages does each alternative have?
 

(Source: production/Operations Management, William J. Stevenson,)

## 2. AN AMERICAN TRAGEDY: HOW A GOOD COMPANY DIED

The Rust Belt is back. So exports surge, long-moribund industries glow with new found profits, and unemployment dips to lows not seen in a decade. But in the smokestack citadels, there's disquiet. Too many machine tool and auto parts factories are silent; too many U.S. industries still can't hold their own.

What went wrong since the heyday of the 1960s? That's the issue Max Holland, a contributing editor of *The Nation*, takes up in his nutsy-boltsy but fascinating study, *When the Machine Stopped*. (Max Holland, *When the Machine Stopped: A Contemporary Tale from industrial America* (Boston, Mass: Harvard Business School Press, 1988))

The focus of the story is Burg master Corp., a Los Angeles-area machine tool maker founded in 1944 by Czechoslovakian immigrant Fred Burg. Holland's father worked there for 29 years, and the author interviewed 22 former employees. His shop-floor view of this small company is a refreshing change from academic treatises on why America can't compete.

The discussion of spindles and numerical control can be tough going. But Holland compensates by conveying the pany's early days and the disgust and cynicism accompanying its decline. Moreover, the fate of Burgmaster and its brethren is crucial to the U.S. industrial economy: Any manufactured item is either made by a machine tool.

Producing innovative turret drills used in a wide variety of metalworking tasks, Burgmaster was a thriving enterprise by 1965, when annual sales amounted to about Rs. 8 million. The company needed backing to expand, however, so it sold out to Buffalo-based conglomerate Houdaille Industries Inc. Houdaille was in turn purchased in a 1979 leveraged buyout led by

Khlberg Kravis Roberts & Co. By 1982, when debt, competition, and a sickly machine-tool market had battered Burgmaster badly, Houdaille went to Washington with a petition to withhold the investment tax credit for certain Japanese-made machine tools.

Thanks to deft lobbying, the Senate passed a resolution supporting Houdaille's position, but President Regan refused to go along. Houdaille's subsequent attempt to link Burgmaster up with a Japanese rival also failed, and Burgmaster was closed.

Holland uses Burgmaster's demise to explore some key issue of economic and trade policy. Houdaille's charge that a cartel led by the Japanese government had injured U.S. toolmakers, for example, became a rallying point for those who would blame a fearsome Japan Inc. for the problems of U.S. industry.

Holland describes the Washington wrangling over Houdaille in painful detail. But he does show that such government decisions are often made without much knowledge of what's going on in industry. He shows, too that Japanese producers succeeded less because of government help than because of government helps than because they made better, cheaper machines.

For those who see LBOs as a symptom of what ails the U.S. economy, Holland offers plenty of ammunition. He argues persuasively that the LBO CRIPPLED Burgmaster by creating enormous pressure to generate cash. As Burgmaster pushed its products out as fast as possible, he writes, it routinely shipped defective machines. It promised customers features that engineers hadn't yet designed. And although KKR disputes the claim, Holland concludes that the LBO choked off Burgmaster's investment funds just when foreign competition made them most necessary. As for Houdaille, it was recapitalized and sold to Britain's Tube Investments Group.

But Burgmaster's problems had started even before the LBO. Holland's history of the company under Houdaille is a veritable catalog of modern management techniques that flopped. One of the most disastrous was a system for computerizing production scheduling that was too crude for complex machine-tool manufacturing. Holland gives a dramatic depiction of supply snafus that resulted in delays and cost increases.

As an independent company, "Burgmaster thrived because the Burgs knew their business," Holland writes. Their departure under Houdaille was followed by an "endless and ultimately futile search for a better formula!" But he concludes: "No formula was a substitute for management involvement on the shop floor!"

In the end, however, Holland puts most of the blame for the industry's decline on government policy. He targets tax laws and macroeconomic policies that encourage LBOs and speculation instead of productive investment. He also criticizes Pentagon procurement policies for favoring exotic, custom machines over standard, low-cost models. This adds up to an industrial policy, Holland writes—a bad one.

The point is well taken, but Holland gives it excessive weight. Like their brethren in Detroit and Pittsburgh, domestic tool-makers in the 1970s were too complacent when imports seized the lower end of the product line. The conservatism that had for years served them in their cyclical industry left them ill-prepared for change. Even now some of the largest U.S. toolmakers are struggling to restructure. Blame the government, yes. But blame the industry, too.

## Questions

1. Write a brief report that outlines the reasons (both internal and external) for Burgmaster's demise, and whether operations management played a significant role in the demise.

(Source: Reprinted from April 17, 1989 issue of *Business Week* by special permission, copyright © 1989 by The McGraw-Hill companies).

### 3. HOME-STYLE COOKIES

#### The Company

The Lew-Mark Baking Company is located in a small town in western New York State. The bakery is run by two brothers, Lew and Mark, who formed the company after they purchased an Archway Cookie franchise. With exclusive rights in New York and New Jersey, it is the largest Archway franchise. The company employs fewer than 200 people, mainly blue-collar workers, and the atmosphere is informal.

#### The Product

The company's only product is soft cookies, of which it makes over 50 varieties. Larger companies, such as Nabisco, Sunshine, and Keebler, have traditionally produced biscuit cookies, in which most of the water has been baked out, resulting in crisp cookies. Archway cookies have no additives or preservatives. The high quality of the cookies has enabled the company to develop a strong market niche for its product.

#### The Customers

The cookies are sold in convenience stores and supermarkets throughout New York and New Jersey. Archway markets its cookies as "good food" no additives or preservatives and this appeals to a health-conscious segment of the market. Many customers are over 45 years of age, and prefer a cookie that is soft and not too sweet. Parents with young children also buy the cookies.

#### The Production Process

The company has two continuous band ovens that it uses to bake the cookies. The production process is called a batch processing system. It begins as soon as management gets orders from distributors. These orders are used to schedule production. At the start of each shift, a list of the cookies to be made that day is delivered to the person in charge of mixing. That person checks a master list, which indicates the ingredients needed for each type of cookie, and enters that information into the computer. The computer then determines the amount of each ingredient needed, according to the quantity of cookies ordered, and relays that information to storage silos located outside the plant where the main ingredients (flour, sugar, and cake flour) are stored. The ingredients are automatically sent to giant mixing machines where the ingredients are combined with proper amounts of eggs, water, and flavorings. After the ingredients have been mixed, the batter is poured into a cutting machine where it is cut into individual cookies. The cookies are then dropped onto a conveyor belt and transported through one of two ovens. Filled cookies, such as apple, date, and raspberry, require an additional step for filling and folding.

The nonfilled cookies are cut on a diagonal rather than round. The diagonal-cut cookies require less space than straight-cut cookies, and the result is a higher level of productivity. In

addition, the company recently increased the length of each oven by 25 feet, which also increased the rate of production.

As the cookies emerge from the ovens, they are fed onto spiral cooling racks 20 feet high and 3 feet wide. As the cookies come off the cooling racks, workers place the cookies into boxes manually, removing any broken or deformed cookies in the process. The boxes are then wrapped, sealed, and labeled automatically.

### **Inventory**

Most cookies are loaded immediately onto trucks and shipped to distributors. A small percentage is stored temporarily in the company's warehouse, but they must be shipped shortly because of their limited shelf life. Other inventory includes individual cookie boxes, shipping boxes, labels, and cellophane for wrapping. Labels are reordered frequently, in small batches, because FDA label requirements are subject to change, and the company does not want to get stuck with labels it can't use. The bulk silos are refilled two or three times a week, depending on how quickly supplies are used.

Cookies are baked in a sequence that minimizes downtime for cleaning. For instance, light-colored cookies (e.g., chocolate chip) are baked before dark-colored cookies (e.g., fudge), and oatmeal cookies are baked before oatmeal raisin cookies. This permits the company to avoid having to clean the processing equipment every time a different type of cookie is produced.

### **Quality**

The bakery prides itself on the quality of its cookies. A quality control inspector samples cookies randomly as they come off the line to assure that their taste and consistency are satisfactory, and that they have been baked to the proper degree. Also, workers on the line are responsible for removing defective cookies when they spot them. The company has also installed an X-ray machine on the line that can detect small bits of metal filings that may have gotten into cookies during the production process. The use of automatic equipment for transporting raw materials and mixing batter has made it easier to maintain a sterile process.

### **Scrap**

The bakery is run very efficiently and has minimal amounts of scrap. For example, if a batch is mixed improperly, it is sold for dog food. Broken cookies are used in the oatmeal cookies. These practices reduce the cost of ingredients and save on waste disposal costs. The company also uses heat reclamation: The heat that escapes from the two ovens is captured and used to boil the water that supplies the heat to the building. Also, the use of automation in the mixing process has resulted in a reduction in waste compared with the manual methods used previously.

### **New Products**

Ideas for new products come from customers, employees, and observations of competitors' products. New ideas are first examined to determine whether the cookies can be made with existing equipment. If so, a sample run is made to determine the cost and time requirements. If the results are satisfactory, marketing tests are conducted to see if there is a demand for the product.

### Potential Improvements

There are a number of areas of potential improvement at the bakery. One possibility would be to automate packing the cookies into boxes. Although labour costs are not high, automating the process might save some money and increase efficiency. So far, the owners have resisted making this change because they feel an obligation to the community to employ the 30 women who now do the boxing manually. Another possible improvement would be to use suppliers who are located closer to the plant. That would reduce delivery lead times and transportation costs, but the owners are not convinced that local suppliers could provide the same good quality. Other opportunities have been proposed in recent years, but the owner rejected them because they feared that the quality of the product might suffer.

### Questions

1. Briefly describe the cookie production process.
2. What are two ways that the company has increased productivity? Why did increasing the length of the ovens result in a faster output?
3. Do you think that the company is making the right decision by not automating the packing of cookies? Explain your reasoning. What obligation does a company have to its employees in a situation such as this? What obligation does it have to the community? Is the size of the town a factor? Would it make a difference if the company was located in a large city? Is the size of the company a factor? What if it was a much larger company?
4. What factors cause Lew-mark to carry minimal amounts of certain inventories? What benefits result from this policy?
5. As a consumer, what things do you consider in judging the quality of cookies you buy in a supermarket?
6. What advantages and what limitations stem from Lew-Mark's not using preservatives in cookies?
7. Briefly describe the company's strategy.

---

---

## GLOSSARY

---

---

**ABC Classification:** Classification of inventory in three groups: an A group comprising items with a less volume and large rupee value, a B group comprising items with moderate volume and moderate rupee value, and C group comprising items with a large volume and small volume.

**Acceptance sampling:** A statistical quality control technique used in deciding to accept or reject a shipment of input or output.

**Activity Chart:** A graphical tool to analyze and time the small, physical actions of workers and machine in performing a routine, repetitive, worker-machine task so that idle time can be identified.

**Aggregate capacity planning:** It is the process of testing the feasibility of aggregate output plans and evaluating overall capacity utilisation.

**Aggregate production (output) planning:** The process of determining output levels of product groups over the coming six to eighteen months on a weekly or monthly basis.

**Automated guided vehicles systems:** An Automated or Automatic Guided Vehicle System (AGVS) is a materials handling system that uses independently operated, self-propelled vehicles that are guided along defined pathways in the floor.

**Automated storage/retrieval systems:** An Automated Storage/Retrieval System (AS/RS) is defined by the Materials Handling Institute as, "A combination of equipment and controls which handles, stores and retrieves materials with precision, accuracy and speed under a defined degree of automation".

**Automation** is a technology concerned with the application of mechanical, electronic, and computer based systems to operate and control production.

**Backorders:** Outstanding or unfilled customer orders.

**Backward Scheduling:** Determining the start and finish times for waiting jobs by assigning them to the latest available time slot that will enable each job to be completed just when it is due, but not before.

- Batch production:** American Production and Inventory Control Society (APICS) as a form of manufacturing in which the job pass through the functional departments in lots or batches and each lot may have a different routing define batch production. It is characterized by the manufacture of limited number of products produced at regular intervals and stocked awaiting sales.
- Bill of Material:** A document describing the details of an item's product buildup, including all component items, their buildup sequence, the quantity needed for each, and the work centers that perform the buildup sequence.
- Bottleneck Operation:** The station on an assembly line that requires the longest task time.
- Breakdown (reactive) maintenance:** Breakdown maintenance is basically the 'run it till it breaks' maintenance mode. No actions or efforts are taken to maintain the equipment as the designer originally intended to ensure design life is reached.
- Break-Even Analysis:** A graphical and algebraic representation of the relationships among volume of output, cost, and revenues.
- Break-Even-Point:** The level of output volume for which total cost equals total revenues.
- Capacity:** A facility's maximum productive capability, usually expressed as volume of output per period of time.
- Capacity planning:** Design of the production system involves planning for the inputs, conversion process and outputs of production operation.
- Capacity requirement planning:** Capacity Requirements Planning (CRP) is an iterative process of modifying the MPS or planned resources to make capacity consistent with the production schedule.
- Carrying (holding) Costs:** Costs of maintaining the inventory warehouse and protecting the inventoried items.
- Cellular layout** The arrangement of a facility so that equipment used to make similar parts or families of parts is grouped together.
- Chance event** An event leading potentially to several different outcomes, only one of which will definitely occur; the decision maker has no control over which outcome will occur.
- Codification** is a process of representing each item by a number, the digit of which indicates the group, the sub-group, the type and the dimension of the item.
- Combination layout:** This is also called the hybrid or mixed type of layout usually a process layout is combined with the product layout. For example, refrigerator manufacturing uses a combination layout. The process or functional layout is used to produce various operations like stamping, welding, heat treatment are carried out in different work centres as per the requirement. The final assembly of the product is done in a product type layout.
- Computer integrated manufacturing:** The term Computer Integrated Manufacturing (CIM) has been coined to denote the pervasive use of computers to design the products, plan the production, control the operations, and perform the various business related functions needed in a manufacturing firm.
- Computer-aided design (CAD)** Computer software programs that allow a designer to carry out geometric transformations rapidly.



**Computer-aided manufacturing (CAM)** Manufacturing systems utilizing computer software programs that control the actual machine on the shop floor.

**Computer-integrated manufacturing (CIM)** Computer information systems utilizing a shared manufacturing database for engineering design, manufacturing engineering, factory production, and information management.

**Consumer's risk (type II error)** The risk or probability of incorrectly concluding that the conversion process is in control.

**Continuous production:** Production facilities are arranged as per the sequence of production operations from the first operations to the finished product. The items are made to flow through the sequence of operations through material handling devices such as, conveyors, transfer devices etc.

**Control chart:** A chart of sampling data used to make inferences about status of a conversion process.

**Controlling:** Activities that assure that actual performance is in accordance with planned performance.

**Enterprise asset management (EAM):** Enterprise asset management is an information management system that connects all departments and disciplines within a company making them an integrated unit.

**Ergonomics (Human engineering):** ILO defines human engineering as, "The application of human biological sciences along with engineering sciences to achieve optimum mutual adjustment of men and his work, the benefits being measured in terms of human efficiency and well-being."

**Factory building:** Factory building is a factor, which is the most important consideration for every industrial enterprise. A modern factory building is required to provide protection for men, machines, materials, products or even the company's secrets.

**Fixed automation** is a system in which the sequence of processing (or assembly) operations is fixed by the equipment configuration.

**Fixed position layout:** This is also called the project type of layout. In this type of layout, the material, or major components remain in a fixed location and tools, machinery, men and other materials are brought to this location. This type of layout is suitable when one or few pieces of identical heavy products are to be manufactured and when the assembly consists of large number of heavy parts, the cost of transportation of these parts is very high.

**Flexible automation** is an extension of programmable automation. A flexible automated system is one that is capable of producing a variety of products (or parts) with virtually no time lost for changeovers from one product to the next.

**Flow diagram:** Flow diagram is a drawing, of the working area, showing the location of the various activities identified by their numbered symbols and are associated with particular flow process chart either man type or machine type.

**Flow process chart:** Flow process chart gives the sequence of flow of work of a product or any part of it through the work centre or the department recording the events using appropriate symbols. It is the amplification of the operation process chart in which operations; inspection, storage, delay and transportation are represented.

**Group layout:** A grouping of equipment for performing a sequence of operations on family of similar components. Group Technology (GT) is the analysis and comparisons of items to group them into families with similar characteristics.

**Infinite loading:** Assigning jobs to work centers without considering the work center's capacity (as if the capacity were infinite).

**Input/output control:** Activities to monitor actual versus planned utilization of a work center's capacity.

**Inspection** is the most common method of attaining standardization, uniformity and quality of workmanship. It is the cost art of controlling the production quality after comparison with the established standards and specifications. It is the function of quality control.

**100% Inspection:** This type will involve careful inspection in detail of quality at each strategic point or stage of manufacture where the test is involved is non-destructive and every piece is separately inspected.

**Inventory** refers to the materials in stock. It is also called the idle resource of an enterprise. Inventories represent those items which are either stocked for sale or they are in the process of manufacturing or they are in the form of materials which are yet to be utilised.

**Inventory control** is a planned approach of determining what to order, when to order and how much to order and how much to stock so that costs associated with buying and storing are optimal without interrupting production and sales.

**Job shop production:** Job shop production are characterized by manufacturing of one or few quantity of products designed and produced as per the specification of customers within prefixed time and cost.

**Just-in-time (JIT):** A manufacturing system whose goal it is to optimize process and procedures by continuously pursuing waste reduction.

**Kaizen** The Japanese concept of continuous improvement in all things.

**Kanban:** Literally, a "visual record;" a method of controlling materials flow through a JIT manufacturing systems by using cards to authorize a work station to transfer or produce materials.

**Layout** Physical location or configuration of departments, work centers, and equipment in the conversion process; spatial arrangement of physical resources used to create the product.

**Lead-time:** The time passing between ordering and receiving goods.

**Lean maintenance** is the application of lean principle in maintenance environments, which recognizes seven forms of waste in maintenance.

**Load-distance model:** An algorithm for laying out work centers to minimize product-flow, based on the number of loads moved and the distance between each pair of work centers.

**Mass production:** Manufacture of discrete parts or assemblies using a continuous process are called mass production. This production system is justified by very large volume of production. The machines are arranged in a line or product layout. Product and process standardization exists and all outputs follow the same path.

**Master production scheduling (MPS):** MPS is a schedule showing week-by-week how many of each product must be produced according to customer orders and demand forecasts.

**Material handling:** Haynes defines, “Material handling embraces the basic operations in connection with the movement of bulk, packaged and individual products in a semi-solid or solid state by means of gravity manually or power-actuated equipment and within the limits of individual producing, fabricating, processing or service establishment”.

**Material requirements planning:** Material Requirement Planning (MRP) is a system of planning and scheduling the time phased material requirements for releasing materials and receiving materials that enable the master production schedule to be implemented.

**Materials management** is a function, which aims for integrated approach towards the management of materials in an industrial undertaking. Its main object is cost reduction and efficient handling of materials at all stages and in all sections of the undertaking. Its function includes several important aspects connected with material such as, purchasing, storage, inventory control, material handling, standardisation etc.

**Mathematical modelling:** Creating and using mathematical representations of management problems and organizations to predict outcomes of proposed courses of action.

**Method study** is the systematic recording and critical examination of existing and proposed ways of doing work, as a means of developing and applying easier and more effective methods and reducing costs.

According to British Standards Institution (BS 3138): “Method study is the systematic recording and critical examination of existing and proposed ways of doing work as a means of developing and applying easier and more effective methods and reducing cost.”

**Methods time measurement:** A widely accepted form of predetermined time study.

**Micro-motion study:** Micro-motion study provides a technique for recording and timing an activity. It is a set of techniques intended to divide the human activities in a groups of movements or micro-motions (called Therbligs) and the study of such movements helps to find for an operator one best pattern of movements that consumes less time and requires less effort to accomplish the task.

**Multiple activity chart:** It is a chart where activities of more than subject (worker or equipment) are each recorded on a common time scale to show their inter-relationship.

**Obsolete items** are these materials and equipments which are not damaged and which have economic worth but which are no longer useful for the company’s operation owing to many reason such as changes in product line, process, materials, and so on.

**Operating characteristic (OC) curve:** Given a sampling plan, the graph of the probability of accepting a shipment as a function of the quality of the shipment.

**Operating system:** An operating system (function) of an organization is the part of an organization that produces the organization’s physical goods and services.

**Operation process chart:** It is also called outline process chart. An operation process chart gives the bird’s eye view of the whole process by recording only the major activities and inspections involved in the process.

**Operations management:** The set of interrelated management activities, which are involved in services management is called as **operations management**.

- Operations planning and scheduling systems:** Operations planning and scheduling systems concern the volume and timing of outputs, the utilisation of operations capacity at desired levels for competitive effectiveness.
- Order quantity:** As part of the operating doctrine, the amount of stock that behavioral sciences.
- Parameters of purchasing:** The success of any manufacturing activity is largely dependent on the procurement of raw materials of right quality, in the right quantities, from right source, at the right time and at right price popularly known as five 'R's' of the efficient purchasing.
- Pegging** The process of tracing through the MRP records and all levels in the product structure to identify how changes in the records of one component will affect the records of one component will affect the records of other components.
- Percent defective:** The percent of units that is defective.
- Plant layout:** Plant layout refers to the physical arrangement of production facilities. It is the configuration of departments, work centres and equipment in the conversion process. It is a floor plan of the physical facilities, which are used in production.  
According to Moore, "Plant layout is a plan of an optimum arrangement of facilities including personnel, operating equipment, storage space, material handling equipment and all other supporting services along with the design of best structure to contain all these facilities".
- Predetermined time study:** A work measurement technique that involves observing or thinking through a job, recording job elements, recording reestablished motion units, and calculating a performance standard.
- Predictive maintenance:** Predictive maintenance can be defined as, "Measurements that detect the onset of a degradation mechanism, thereby allowing causal stressors to be eliminated or controlled prior to any significant deterioration in the component physical state. Results indicate current and future functional capability".
- Preventive maintenance:** Preventive maintenance can be defined as follows: Actions performed on a time or machine-run-based schedule that detect, preclude, or mitigate degradation of a component or system with the aim of sustaining or extending its useful life through controlling degradation to an acceptable level.
- Preventive maintenance (PM):** JIT Philosophy espousing daily, extensive checkups and repairs for production equipment, lengthening their useful life well beyond the traditional time frame.
- Process design:** Process design is a macroscopic decision-making of an overall process route for converting the raw material into finished goods.
- Process layout:** This layout is recommended for batch production. All machines performing similar type of operations are grouped at one location in the process layout *e.g.*, all lathes, milling machines, etc., are grouped in the shop will be clustered in like groups.
- Procurement costs:** Costs of placing an order, or setup costs if ordered items are manufactured by the firm.
- Producer's risk (type I error)** The risk or probability of incorrectly concluding that the conversion process is out of control.

**Product development and design** is the process of developing a new product with all the features, which are essential for effective use in the field, and designing it accordingly. At the design stage, one has to take several aspects of design like, design for selling, design for manufacturing and design for usage.

**Product layout:** In this type of layout, machines and auxiliary services are located according to the processing sequence of the product. If the volume of production of one or more products is large, the facilities can be arranged to achieve efficient flow of materials and lower cost per unit. Special purpose machines are used which perform the required function quickly and reliably.

**Product life cycle:** Pattern of demand throughout the product's life; similar patterns and stages can be identified for the useful life of a process.

**Production management** deals with decision-making related to production processes so that the resulting goods or services are produced according to specifications, in the amount and by the schedule demanded and out of minimum cost.

**Production planning and control** can be defined as, "the direction and coordination of firms' resources towards attaining the prefixed goals".

**Production planning and control:** Production planning and control can be defined as the process of planning the production in advance, setting the exact route of each item, fixing the starting and finishing dates for each item, to give production orders to shops and to follow up the progress of products according to orders.

The principle of production planning and control lies in the statement 'First Plan Your Work' and then 'Work on Your Plan'.

**Production system:** The production system of an organization is that part, which produces products of an organization. It is that activity whereby resources, flowing within a defined system, are combined and transformed in a controlled manner to add value in accordance with the policies communicated by management.

**Productivity:** Efficiency; a ratio of outputs to inputs. Total factor productivity is the ratio of outputs to the total inputs of labor, capital, materials, and energy; partial factor productivity is the ratio of outputs to one, two or three of these inputs.

**Programmable automation,** the production equipment is designed with the capability to change the sequence of operations to accommodate different product configurations.

**Purchasing** is an important function of materials management. In any industry purchase means buying of equipments, materials, tools, parts etc. required for industry.

**Purchasing:** Activities relating to procuring materials and supplies consumed during production.

**Quality** is a measure of how closely a good or service conforms to specified standard.

Quality standards may be any one or a combination of attributes and variables of the product being manufactured. The attributes will include performance, reliability, appearance, commitment to delivery time, etc.

**Quality:** The degree to which the design specifications for a product or service are appropriate to its function and use, and the degree to which a product or service conforms to its design specifications.

- Quality and control:** Different meaning could be attached to the word quality under different circumstances. The word quality does not mean the quality of manufactured product only. It may refer to the quality of the process (*i.e.*, men, material, and machines) and even that of management.
- Quality control:** Quality Control (QC) may be defined as “a system that is used to maintain a desired level of quality in a product or service”. Quality control can also be defined as “that industrial management technique by means of which product of uniform acceptable quality is manufactured”. It is the entire collection of activities that ensures that the operation will produce the optimum quality products at minimum cost.
- Quality circle (QC):** A small group of employees who meet frequently to resolve company problems.
- Recorder point:** As part of the operating doctrine, the inventory level at which stock should be recorded.
- Reliability:** Reliability is the probability of survival under a given operating environment. For example, the time between consecutive failures of a refrigerator where continuous working is required is a measure of its reliability. If this time is more, the product is said to have high reliability.
- Reliability centered maintenance:** Reliability Centered Maintenance (RCM) is defined as “a process used to determine the maintenance requirements of any physical asset in its operating context”.
- Resource requirement planning:** Resource requirements planning (rough-cut capacity planning) is the process of testing the feasibility of master production schedule in terms of capacity. This step ensures that a proposed MPS does not inadvertently overload any key department, work centre, or machine, making the MPS unworkable.
- Rough-cut capacity planning:** The process of testing the feasibility of master production schedules in terms of capacity.
- Routing:** The processing steps or stages needed to create a product or to do a job.
- Sampling inspection:** In this method randomly selected samples are inspected. Samples taken from different patches of products are representatives.
- Scheduling** is the function of coordinating all of the logistical issue around the issues regarding the execution phase of the work. Scheduled of maintenance jobs basically deals with answering two questions—‘Who’ and ‘When’ of job, *i.e.*, “who would do the job” and “when the job would be started and done”.
- Scrap** is defined as process wastage, such as turnings, borings, sprues and flashes. They may have an end-use within the plant having commercial values. Hence, should be disposed of periodically.
- Shortest-processing-time rule (SPT)** A priority rule that gives top priority to the waiting job whose operation time at a work center is shortest.
- SIMO chart:** Simultaneous Motion Cycle chart (SIMO chart) is a recording technique for micro-motion study. A SIMO chart is a chart based on the film analysis, used to record simultaneously

on a common time scale the Therbligs or a group of Therbligs performed by different parts of the body of one or more operators.

**Six sigma maintenance:** It is the application of six sigma principles in maintenance. Six sigma is a maintenance process that focuses on reducing the variation in business production processes.

**Statistical process control:** Statistical Process Control (SPC) is the application of statistical techniques to determine whether the output of a process conforms to the product or service design.

**Stores management:** This involves physical control of materials, preservation of stores, minimization of obsolescence and damage through timely disposal and efficient handling, maintenance of stores records, proper location and stocking.

**String diagram:** The string diagram is a scale layout drawing on which, length of a string is used to record the extent as well as the pattern of movement of a worker working within a limited area during a certain period of time.

**Surplus items** are those materials and equipments which have no immediate use but have accumulated due to faulty planning, forecasting and purchasing. However, they have a usage value in future.

**Total quality management** is an effective system of integrating the quality development, quality maintenance and quality improvement efforts of various groups in an organization so as to enable marketing, engineering, production and service at the most economical levels which allow for full customer satisfaction.

**Two handed process chart:** A two handed (operator process chart) is the most detailed type of flow chart in which the activities of the workers hands are recorded in relation to one another. The two handed process chart is normally confined to work carried out at a single workplace. This also gives synchronised and graphical representation of the sequence of manual activities of the worker.

**Value analysis** is defined as “an organized creative approach which has its objective, the efficient identification of unnecessary cost—cost which provides neither quality nor use nor life nor appearance nor customer features”.

**Work measurement** is the application or techniques designed to establish the time for a qualified worker to carry out a specified job at a defined level or performance.

**Work-study** is a generic term for those techniques, method study and work measurement which are used in the examination of human work in all its contexts. And which lead systematically to the investigation of all the factors which affect the efficiency and economy of the situation being reviewed, in order to effect improvement.

---

---

## EXAMINATION QUESTION BANK

---

---

### PLANT LAYOUT AND LOCATION & MATERIAL HANDLING

1. Define plant layout and give its objectives.
2. What are the various types of layouts ? Explain and give their relative advantages.
3. State the factors governing the choice of site for a manufacturing plant in a city or a sub-urban part of a country.
4. Suggest suitable locations for the plants of following products:
  - (i) Ships,
  - (ii) Cameras,
  - (iii) Readymade garments and
  - (iv) Antibiotic medicines.

Give reasons for your choice.

5. Define plant layout. Describe the major steps of planning any layout.
6. Discuss product type layout, where it is used. State its advantages and disadvantages.
7. Essential difference between product layout and process layout.
8. Explain the three basic layouts.
9. How to develop the process and product layout?
10. Explain the term 'material handling'. What are the advantages of a well planned and integrated system of material handling?
11. What do you understand by 'Plant Design'? Discuss the various factors to be considered in deciding the location of a plant.
12. To compare three sites, the various factors are listed, as given below. Select the optimal location and give reasons for your choice:



<i>Site A</i>	<i>Site B</i> Rs.	<i>Site C</i> Rs.	Rs.
Rent	20,000	10,000	10,000
Labour	1,35,000	1,30,000	1,60,000
Freight charges	81,000	64,000	28,000
Taxes	Nil	3,500	2,000
Power	6,000	6,000	6,000
Community attitude	Indifferent	Want business	Indifferent
Employee housing	Excellent	Adequate	Poor

13. A new young entrepreneur wants to set up a small plant. There are three different possible sites with different advantages. The total initial investments going to be of the order of Rs. 2,00,000. Calculate rates of return of the three sites and choose the optimal location for the purpose of locating the small plant.

	<i>Site A</i> Rs.	<i>Site B</i> Rs.	<i>Site C</i> Rs.
1. Expected sales	2,50,000	2,50,000	3,00,000
2. Distribution expenses	40,000	40,000	75,000
3. Raw material	90,000	80,000	70,000
4. Cartage	20,000	25,000	35,000
5. Power & Water supply	20,000	30,000	30,000
6. Wages & Salaries	25,000	30,000	25,000
7. Other expenses	15,000	15,000	20,000

[Ans. 20%, 15%, 22.5% : Site C]

$$\text{N.B. Rate of return} = \frac{\text{Total sales} - \text{Total expenses}}{\text{Total investment}} \times 100$$

14. What factors are considered while designing a factory building? Will you prefer an 'L' shape building or a rectangular building for a new plant? Why?
15. Give the advantages of a multistorey building over a single storey building for a factory.

#### MOTION AND TIME STUDY

16. Define production and productivity. Explain the difference between the two.
17. There are three car manufacturing factories A, B and C, and they are producing the same type of cars. They are employing 1000, 2000 and 3000 men and producing 10, 15 and 25 cars per month respectively. Find the labour productivity of each firm and the production of each firm per year.

[Ans. (i) 1/100, 3/400, 1/400, 1/120 (ii) 120, 180, 300]

18. What do you understand by productivity? In what units can it be expressed?
19. A manufacturing concern was producing 120 locomotives per year by employing 20,000 men in the past. To increase production they have now recruited 1,000 men more and as a result production has increased to 140 locomotives per year. Find:
  - (i) What was the labour productivity previously?
  - (ii) What is the labour productivity now?
  - (iii) What is the percentage increase in production and productivity?

[Ans. (i) 3/500 (ii) 1/150 (iii) 16.6%, 11.1%]
20. What is the difference between method study and work measurement? State the objectives of both.
21. What steps are followed for doing a method study of job process?
22. In method study all activities can be recorded with the help of certain symbols. Write the symbols and explain what each stands for.
23. What are the objectives of method study?
24. Which are the recording techniques used in the method improvement?
25. Enumerate the principles of motion economy pertaining to work place layout.
26. In estimating the standard time of a job, what different elements of time are considered? Explain.
27. Write the procedure of time study.
28. Describe the steps for taking a time study.
29. Why is it necessary to apply rating to the actual time which an operators takes to perform an operation?
30. What are the various allowances considered in time study?
31. Define standard time, basic time, observed time and rating factor. Write the relations between these quantities and allowances.
32. The normal cycle time for an operation is 1.14 minutes. It is estimated that 405 minutes of 480 minutes day are available to the operators for production purposes. Determine the standard time (S.T.) and the number of pieces for a standard hour.

[Ans. S.T.= 1.35 minutes, 44 pieces]
33. What is the purpose of work measurement? Enumerate its users.
34. What are the various allowances considered in time study?
35. Define 'Rating'. What is its necessity?
36. What is utility of man-machine chart? How such chart can be drawn?
37. Write short note on performance rating.
38. What are the techniques of work measurement? Explain each of them briefly.
39. Why is a jobs broken down into elements and what are the general rules for selection of elements?
40. With nicely drawn charts explain the significant characteristics of 'man-machine' and 'multiple activities' charts.

41. What are the basic differences between:
  - (i) Operation process chart and Flow process chart, and
  - (ii) Flow diagram and String diagram.
42. Explain how with the help of ergonomic concepts motion economy can be ensured in designing a work-place-layout.
43. Explain how 'work study' concepts can be utilised to improve 'productivity'.
44. Explain the term 'work-study'. State some of its applications in industries.
45. Explain the following:
  - (i) Flow diagram
  - (ii) Work-measurement.
46. Explain the roles of man-machine chart and two-hand process chart in workplace layout.
47. Under what conditions would you employ the principles of motion economy in developing a workplace layout?
48. What information is contained in an operation chart?
49. Discuss briefly the principles of micro-motion study and the basic 'Therbligs' as advocated by Gilbreth.
50. Enumerate the principles of motion economy with particular reference to workplace layout and ergonomic design of a product.
51. Write short notes on multiple activity and SIMO charts.
52. Training of time study observer by rating film and how to reduce human error caused by conservatism.
53. What is productivity? Mention the benefits of higher productivity.
54. Explain the productivity of land, buildings, machines and manpower.
55. What are the factors contributing to productivity improvement?
56. Determine how productivity can be improved by reducing work.
57. Define work study and explain its basic procedure.
58. What are the prerequisites of conducting work study?
59. Define method study and its procedures.
60. Explain the factors involved in the selection of job.
61. Explain the various process chart symbols with notations.
62. What are the primary and secondary questions involved in method study?
63. State and explain the principles of motion economy.
64. Explain the two-handed process chart.
65. What is micro-motion study, explain its importance.
66. Sketch the various Therbligs symbols, with its abbreviations.
67. What is work measurement and describe the various purpose involved.
68. What are the basic procedure and techniques of work measurement?
69. Explain the basic steps for conducting time study.

70. What are relaxation allowances and how is it calculated?
71. What are the various allowances considered in time study?
72. The observed time is recorded to be 15 minutes for a job done by a worker whose rating is 80. Following allowances are recommended by the management:
  - Personal needs allowance—5% of basic time
  - Basic fatigue allowance—2% of basic time
  - Contingency work allowance—1% of basic time
  - Contingency delay allowance—2% of basic timeDetermine basic time, work content and standard time for the job.
73. How is interference allowance different from other allowances?
74. Explain the technical set-up and work specification of time standard.
75. List and explain the various uses of time standard.
76. Why would combining work measurement techniques be a good strategy in establishing a standard?
77. Determine the standard time using the experienced industrial engineers worker rating.
78. Find the standard times using the worker rating of inexperienced engineer.

#### PRODUCTION PLANNING AND CONTROL

79. What do you understand by 'Centralised Production Planning and Control'? Give its advantages.
80. Define process planning. Why is it required?
81. List and explain the factors to be considered in detail before deciding a process plan for a job.
82. What do you understand by the 'follow-up' function of production planning and control? Explain.
83. Give a specimen of 'Gantt Charts' which is normally used in the production planning and control department and describe briefly how it could be used for checking the actual progress of a job against the schedule.
84. Difference between loading and scheduling.
85. Describe the objectives and functions of production planning and follow-up.
86. What is the main difference between planning and follow-up.
87. Describe clearly the function of routing, scheduling and dispatching?
88. Show how the Gantt chart is used for planning a project?
89. Describe clearly the function of routing scheduling inspection procedures.
90. Show how the Gantt chart is used for planning a project?
91. Describe clearly the function of routing, scheduling and dispatching.
92. Describe what is the utility of Gantt chart as a tool of production. Prepare a Gantt chart showing picture of future operation?
93. Define operations management.
94. Explain the operation management responsibility.

95. Explain the operation functions in organization.
96. Explain manufacturing operations versus service operations.
97. Explain the historical evolution of production and operations management.
98. Explain the framework for managing operations.
99. How is product development and design associated with production planning?
100. Explain the effects of three S?
101. What is the role of models in operation management?
102. Explain the general procedure for facility location planning. What are the different types of manufacturing and service operations?
103. Explain how project planning and project scheduling relate.
104. Discuss how a Gantt chart can be used as a scheduling tool?
105. Identify the relevant costs that should be considered in developing a plan for aggregate output and capacity.
106. How is rough-cut capacity and aggregate capacity planning compared?
107. What are the merits and demerits of the three pure strategies of aggregate planning process?
108. What roll does forecasting play in aggregate planning process?
109. Explain how aggregate plans and MPS initiate functional activities.
110. Explain how aggregate planning and scheduling cost are affected by forecast errors.
111. Describe the critical parameters of job shop scheduling problem.
112. Identify the elements of human behaviour that are affected by job shop scheduling.
113. Is job shop scheduling a planning activity or a control activity? Explain.
114. What are priority-sequencing rules? Why are they needed.
115. Discuss major difference between finite and infinte loading.
116. What types of demands are formally considered in MRP?
117. Explain the MRP system. Discuss different inputs and outputs of MRP.
118. What are the logics used in MRP? Explain its methodology.

### MATERIALS MANAGEMENT

119. Find the economic batch quantity from the following data:

Cost of carrying inventory	—	15% of value per year
Set up cost	—	Rs. 5,000 per batch
Average yearly consumption	—	3,000 units
Cost per unit	—	Rs. 100

[Ans. 1414, 1500]

120. Find the economic batch quantity for manufacturing 20,000 fountain pens per year:

Value of raw material in each fountain pen	=	2.00
Labour including on cost per fountain pen	=	2.50
Set up cost per batch	=	Rs. 600.00
Cost of carrying inventory	=	12 per cent of the value per year

[Ans. 6667]

121. What is meant by economic batch quantity? Derive the formula for it.
122. Determine the economic batch quantity from the following data:
- |                            |  |
|----------------------------|--|
| Total sales in a year      | = 1500 units                               |
| Set up cost per job order  | = Rs. 1800                                 |
| Cost of unit product       | = Rs. 120                                  |
| Inventory carrying charges | = 10 per cent of the value of the product. |
- [Ans. Calculated 668]
123. What is the object of inventory control? Explain.
124. Find the economic order quantity from the following data:
- |                          |                                  |
|--------------------------|----------------------------------|
| Average annual demand    | = 30,000 units                   |
| Inventory carrying cost  | = 12% of the unit value per year |
| Cost of placing an order | = Rs. 70                         |
| Cost per unit            | = Rs. 2                          |
125. Discuss the concept and utility of ABC analysis as applied to inventory control.
126. Explain briefly ABC analysis.
127. What are basic components of an inventory system?
128. In what ways can inventories serve to reduce the cost and to increase the cost?
129. Determine the economic order quantity for a product whose average daily consumption rate is 80 units. The cost of each unit is Re. 0.50 and the inventory carrying charges is Re. 0.20. The cost of placing and receiving the order is Rs. 10. Assuming total working days in a year as 300, obtain the annual inventory capital also.
130. Explain the term inventory. How would you classify it? Explain, how you would carry out material requirement planning? State the basic steps involved in setting up MRP.
131. Discuss the functions of purchasing department in an industry. Explain some methods of purchasing commonly adopted in an industrial purchasing. Why should the purchasing documents be legally sound?
132. In what way can inventories serve to reduce costs? Explain the term 'economic order quantity' and how you would compute it. State all the assumptions made.
133. Define ergonomics and discuss the factors of ergonomics.
134. What is the scope and importance of materials management?
135. What do you mean by materials management?
136. What is the need for integrated concept and also mention the advantages of integrated materials management concept?
137. What are micro and macro factors in materials management and explain in detail?
138. What is the importance and scope of purchasing in materials management?
139. What are the objectives/goals and functions of purchasing department in materials management?
140. What are the various types of purchase systems? Explain various stages under each system in detail.

141. What are the differences between purchasing capital equipment and purchasing of consumption materials?
142. Explain the preparations of forms and records for purchasing with examples.
143. What are the various methods of purchasing (open purchase, restricted enquiry, open tender enquiry) and explain these importance and steps in each method.
144. What are the differences between centralized and decentralized purchasing and their advantages?
145. What is vendor development and what are various steps in source selection?
146. What is supplier evaluation and mention various steps in selecting best supplier?
147. What is stores management and mention the objectives and functions of stores management?
148. Mention and explain various stores systems and procedures.
149. Mention and explain various store accounting and stock verification procedures.
150. Explain in detail about obsolete, surplus and scrap management.
151. Define codification, standardization and simplification and also mention advantages and disadvantages on each.
152. What is ABC, FSND, and VED analysis and explain their importance in materials management?
153. What are various mechanisms and advantages of ABC analysis?
154. What are the need, scope and importance of keeping inventory in any firm?
155. Explain clearly the various costs that are involved in inventory problems with suitable examples. How they are inter-related?
156. What is an inventory system? Explain clearly the different costs that are involved in inventory problems with suitable examples.
157. What are the basic ideas involved in EOQ concept? Discuss.
158. What is economic order quantity?
159. An aircraft company uses rivets at an approximate customer rate of 2,500 kg per year. Each unit costs Rs. 30 per kg. and the company personnel estimate that it costs Rs. 130 to place an order, and that the carrying cost inventory is 10% per year. How frequently should orders for rivets be placed? Also determine the optimum size of each order.
160. A manufacturing company purchases 9,000 parts of a machine for its annual requirements, ordering one-month usage at a time. Each part costs Rs. 20. The ordering cost per order is Rs. 15, and the carrying charges are 15% of the average inventory per year. You have been asked to suggest a more economical purchasing policy for the company. What advice would you offer, and how much would it save the company per year?
161. The demand of an item is uniform at a rate of 25 units per month. The fixed cost is Rs. 15 each time a production is made. The production cost is Re. 1 per item, and the inventory carrying cost is Re. 0.30 per item per month. If the shortage cost is Rs. 1.50 per item per month, determine how often to make a production run and of what size it should be?

162. Define the terms 'safety stock' and 'EOQ' with the help of ideal inventory model.
163. Explain the problem of inventory control with deterministic demand.
164. What is ABC analysis? Why is it necessary? What are the basic steps in implementing it?
165. Explain the importance of 'ABC' analysis in the problem of inventory control of an organization using a large number of items.
166. Explain the basis of selective inventory control and state the different selection techniques adopted in inventory control system. Give a brief note on each.
167. Explain the concept of JIT. How does it help the manufacturing system to improve productivity?
168. Explain the basic elements of JIT.
169. What are the merits and demerits of JIT?
170. What do you understand by kanban? Explain the method to calculate the number of kanban?
171. Explain the philosophy involved in JIT systems. What are the major requirements for a successful JIT implementation?

### QUALITY CONTROL

172. What is importance of inspection in an industry? Describe the various kinds of inspections.
173. Sub-groups of five items each are taken from a manufacturing process at regular intervals. A certain quality characteristics is measured, and  $\bar{X}$  and R values are calculated for each sub-group. After 25 subgroups  $\bar{X} = 357.50$  and  $R = 9.90$ . Compute the control limits. It is assumed that all the points lie within both the control charts.

[Ans.  $\bar{X}$  chart 14.53, 14.07, R chart 0.835, 0]

174. What is inspection? What is the basic difference between inspection and quality control?
175. The results of inspection of 10 samples each containing 4 units are tabulated in the following form. Compute the control limits for the  $\bar{X}$  and R charts.

No. of Observations	Sub-group size				Average	Range
	a	b	c	d	$\bar{X}$	R
1	47	32	44	35	39.50	15
2	33	33	34	34	33.50	1
3	34	34	31	34	33.25	3
4	12	21	24	47	26.00	35
5	35	23	38	40	34.00	17
6	19	37	31	27	28.50	18
7	23	45	26	37	32.75	22
8	33	12	29	43	29.25	31
9	25	22	37	33	29.25	15
10	29	32	30	13	26.00	19

[Ans.  $\bar{X}$  Chart 42.866, 17.75; R Chart 39.216]



176. What do you understand by acceptance sampling? When is it used? Give its advantages and disadvantages.
177. Describe briefly the double acceptance sampling plan.
178. Describe the single sampling and double sampling inspection procedures.
179. What are factors that determine sample size?
180. State some possible objectives  $\bar{X}$  and R charts.
181. Determine the control limit for  $\bar{X}$  and R chart if  $E\bar{X} = 357.50$ ,  $ER = 9.90$ , number of sub-groups = 20. It is given that  $A_2 = 0.18$ ,  $D_3 = 0.41$  and  $D_4 = 1.59$ .
182. Discuss briefly the S.Q.C. procedures by charts and diagrams. What is meant by 'quality circle'? Is there any additional benefit derived from this?
183. Explain the terms 'quality' and 'quality control'. How does quality control differ from conventional inspection?
184. Explain the following terms in reference to quality control:  
(i) Producer's risk, (ii) Consumer's risk, (iii) Average outgoing quality, (iv) Single sampling plan of inspection, and (v) p-chart.
185. What are the major points to be looked into while introducing statistical control charts for quality assurance in an industry? Show typical X and R charts. With reference to S.Q.C., define clearly the terms Specified: acceptance quality level (A.Q.L), Product's risk, Consumer's risk, Operating characteristics curve (O.C).
186. Discuss the importance of quality control in an industry. Why is statistical quality control preferred? Explain.
187. Discuss the general structure for double sampling plan. What are its advantages and disadvantages? Explain.
188. Define quality and explain its role in the modern business environment.
189. What are the benefits of quality control?
190. Define the inspection? What are the types of inspection?
191. What are the objectives of inspection?
192. Differentiate sampling inspection and 100% inspection.
193. Explain the difference between quality control and quality improvement.
194. What are the drawbacks of centered approach inspection?
195. Define the attributes and variables.
196. Differentiate the attributes and variables.
197. What are the benefits of quality control?
198. State the objectives of inspection. In a mass production how the stage inspections are favourable?
199. Define quality circles.
200. Explain the objectives of quality circles.
201. What is the difference between quality circles and quality improvement teams?

202. What are the 7QC tools? Explain.
203. Explain briefly TQC.
204. What are the disadvantages of TQC?
205. What are the benefits of using control charts?
206. Differentiate between discrete data and continuous data, with suitable examples.
207. Explain the difference between chance causes and assignable causes. Give examples of each.
208. Define and explain type I and type II errors in the context of control charts. How does the choice of control limits influence these two errors?
209. How are rational samples selected? Explain the importance of this in the total quality systems approach.
210. Explain some causes that would make the control chart pattern follow a gradually increasing trend.
211. What is the effect of sample size on control limits?
212. What are the advantages and disadvantages of using variables rather than attributes in control charts?
213. Explain the difference in interpretation between an observation falling below the lower control limit on an X-bar chart and one falling below the lower control limit on an R-chart. Discuss the impact of each on the revision of control charts.
214. State the objective of X-bar and R charts. Compare X-bar with R chart. Discuss the circumstances in which either of the two or a combination of these will be used for the purpose of control.
215. What kinds of errors are possible when control charts for variables are applied? Explain.
216. Explain the concept of process capability. When should it be estimated? Discuss its impact on the production of scrap and/or rework.
217. What are the objectives of the control charts?
218. What are the advantages and disadvantages of control charts for attributes over those of variables?
219. Discuss the assumptions that must be satisfied to justify using a  $p$ -chart. How are they different from the assumptions required for a C-chart?
220. How do you construct and interpret the X-bar and R-chart?
221. How do you construct and interpret the  $p$ -chart?
222. Explain the difference between specification limits and control limits. Is there a desired relationship between the two?
223. Explain the difference between natural tolerance limits and specification limits. What assumption is made in constructing the natural tolerance limits?
224. What is process capability analysis, and when should it be conducted? What are some of its benefits?
225. Differentiate the process capability and specifications.
226. What is process capability?

227. What are the methods for evaluating the process capability?
228. What are process capability indices?
229. In an automatic filling process 175 gm of a certain chemical is delivered into each container. The permissible variation is  $\pm 4$  gm. To investigate the capability of the process, samples of 5 each, were taken from 10 successive batches, and data were recorded, as given below:

<i>Batch</i>	<i>1</i>	<i>2</i>	<i>3</i>	<i>4</i>	<i>5</i>	<i>6</i>	<i>7</i>	<i>8</i>	<i>9</i>	<i>10</i>
Weight of each sample of 5	177	176	174	175	175	176	170	177	174	175
	176	178	177	178	175	177	175	177	181	175
	177	178	177	180	174	178	178	172	174	174
	178	180	176	172	173	178	177	176	176	175
	175	175	175	176	174	175	173	177	175	173

Assuming the process to be within control establish the capability of the process and compare it with standard specifications.

230. The following are the X-bar and R-values of 4 subgroups of readings: X-bar = 10.2, 12.1, 10.8 and 10.9, R = 1.1, 1.3, 0.9 and 0.8. The specification limits for the components are  $10.7 \pm 0.2$ . Establish the control limits for X-bar and R-charts. Will the product able to meet it specification?
- Given: (a)  $A_2$  (factor for X-bar chart) = 0.58  
 (b)  $D_4$  (factor for R chart) = 2.11  
 (c)  $D_3$  (factor for R chart) = 0.00
231. A certain dimension is specified in mm as  $3.5100 \pm 0.0050$ . Control charts for X-bar and R indicate that the X-bar chart shows lack of statistical control but the R chart always shows control. From the R chart the estimate of  $\sigma'$  is 0.0010. If the aimed at process average  $X'$ -bar is to be 3.5100, what should be the upper control limit for X-bar with a subgroup size of 4? What should be the upper reject limit on the X-bar chart assuming the use of 3-sigma reject limits?
232. The following are the inspection results of 20 lots of magnets, each lot being of 750 magnets. Number of defective magnets in each lot is 48, 56, 47, 71, 83, 48, 50, 53, 70, 67, 47, 34, 85, 37, 57, 29, 45, 52, 51, and 30. Calculate the average fraction defective and three sigma control limits for *p*-chart and state whether the process is in control.
233. Discuss the advantages and disadvantages of sampling.
234. Distinguish between producer's risk and consumer's risk.
235. What is the importance of OC curve in the selection of sampling plans?
236. Describe the impact of the sample size and the acceptance number on the OC curve.
237. Discuss the relative advantages and disadvantages of single, double and multiple sampling plans.

238. Explain the acceptance-rejection plans.
239. Explain the terms AOQ and AOQL for single sampling and double sampling plans.
240. What are the advantages and disadvantages of variable sampling plans over those for attributes?
241. What are the parameters of a variable sampling plan for which the process average quality is of interest?
242. Differentiate the attribute sampling plan and variable sampling plan.
243. State and explain the advantages and limitations of acceptance sampling over 100% inspection.
244. What do you mean by ISO 9000?
245. What are the various causes in ISO 9000?
246. Explain the goals and standards of ISO 9000 quality systems.

### STATISTICAL TABLE

Factors for determining from  $\bar{R}$  the 3-sigma control limits for  $\bar{X}$  and  $R$  charts

Number of observations in subgroup, $N$	Factors for $\bar{X}$ Chart, $A_2$	Factors for $R$ chart	
		Lower control limit $D_3$	Upper control limit $D_4$
2	1.88	0	3.27
3	1.02	0	2.57
4	0.73	0	2.28
5	0.58	0	2.11
6	0.48	0	2.00
7	0.42	0.08	1.92
8	0.37	0.14	1.86
9	0.34	0.18	1.82
10	0.31	0.22	1.78
11	0.29	0.26	1.74
12	0.27	0.28	1.72
13	0.25	0.31	1.69
14	0.24	0.33	1.67
15	0.22	0.35	1.65
16	0.21	0.36	1.64
17	0.20	0.38	1.62
18	0.19	0.39	1.61
19	0.19	0.40	1.60
20	0.18	0.41	1.59